

Toggle Switches, A Series, Options

FUNCTIONS

The following functions available in SP or DP.



| | | | | | | | |
|--|----------------|--|---------------------|--|--------------------------|-------------------------------|--|
| <p>TOGGLES</p> <p>S Standard</p> | | <p>M Short</p> | | <p>P3 P4</p> | | <p>T2P Flatted</p> | |
| Dimension "L" | Bushing | Dimension "L" | Bushing Type | Actuator | Dimension "A" "B" | | |
| .410 (10.41) | "Y", "H", "CW" | .200 (5.08) | "Y", "H", "CW" | P3 | .450 (11.43) | .200 (5.08) | |
| .480 (12.19) | "D", "D9" | .270 (6.86) | "D", "D9" | P4 | .250 (6.35) | .165 (4.19) | |
| <p>T Large Toggle/ Bushing</p> | | <p>T1 Large Toggle/ Bushing</p> | | <p>K Locking</p> | | <p>K1 Locking</p> | |
| <p>No bushing option needed for "T" or T1".</p> | | | | <p>No bushing option needed for "K" or K1" "K" locking levers are used to prevent accidental switching and must be lifted up prior to actuation. Standard nickel finish.</p> | | | |

Toggle Switches, A Series, Options

BUSHINGS

Y

1/4-40 Thread
.35" long, slotted
(Standard)

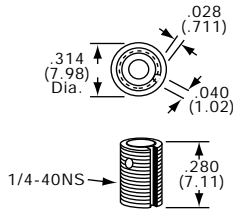

D9

Unthreaded
.28" long

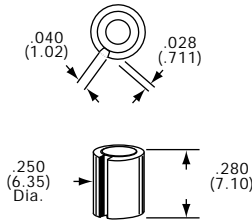

Used with
Z, C & W
terminations

H

1/4-40 Thread
Flanged, .30" long

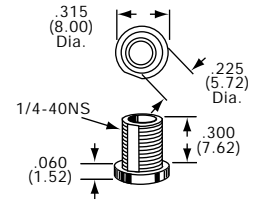

D

1/4-40 Thread
.28" long, slotted

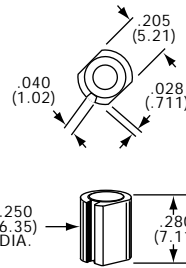
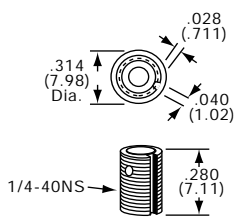

Used with
A, AV2, V30
V80 & V90
terminations

CW

Threaded
Splashproof

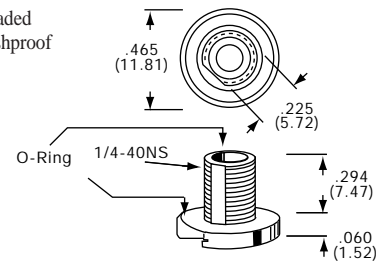

For S & M Toggles

TERMINALS

Z

Wire Lug

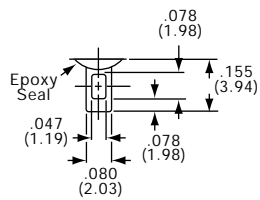

Z3

Quick Connect

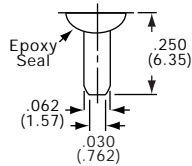

Mates with Tyco
61454 or 60900.

W

Wire Wrap

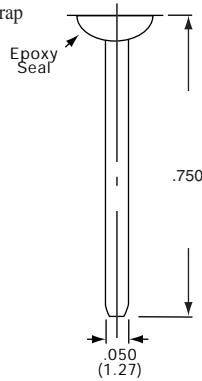

C

Printed Circuit

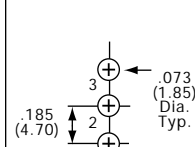
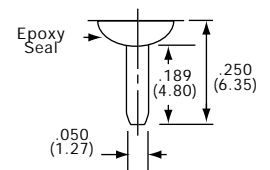

Single pole

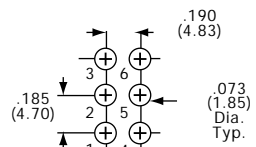

Double pole

Gemini Series

Toggle Switches, A Series, Options

TERMINALS



Right Angle
Single Pole



Gemini Series

Note: Terminal numbers viewed from top of P.C. boards.

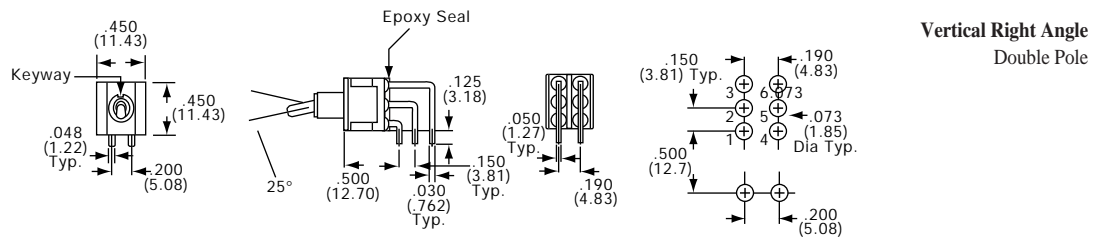

Note: Terminal numbers viewed from top of P.C. boards.

Toggle Switches, A Series, Vertical, Wire Lug, Long Bat Actuator

SPDT

| Tyco Electronics | Alcoswitch | Type | Act. Code P.M5 | | | |
|------------------------|------------|------|----------------|------|------|------|
| Silver Contacts | | | | | | |
| 5-1437554-0 | A101SYZQ | SPDT | 1 | On | None | On |
| 7-1437554-7 | A103SYZQ | SPDT | 5 | On | Off | On |
| 9-1437554-6 | A105SYZQ | SPDT | 5 | (On) | Off | (On) |
| 1437555-9 | A107SYZQ | SPDT | 5 | On | Off | (On) |
| 2-1437555-0 | A108SYZQ | SPDT | 1 | On | None | (On) |
| Gold Contacts | | | | | | |
| 4-1437554-9 | A101SYZB | SPDT | 1 | On | None | On |
| 7-1437554-6 | A103SYZB | SPDT | 5 | On | Off | On |
| 9-1437554-5 | A105SYZB | SPDT | 5 | (On) | Off | (On) |
| | A107SYZB | SPDT | 5 | On | Off | (On) |

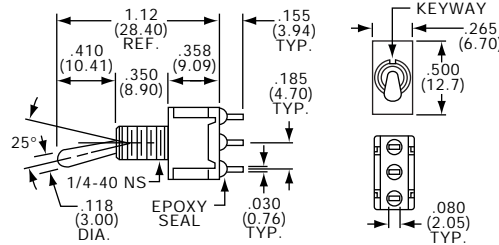

A101SYZQ

Gemini Series

DPDT

| Tyco Electronics | Alcoswitch | Type | Act. Code P.M5 | | | |
|------------------------|------------|------|----------------|------|------|------|
| Silver Contacts | | | | | | |
| 4-1437555-9 | A201SYZQ | DPDT | 2 | On | None | On |
| 6-1437555-2 | A203SYZQ | DPDT | 6 | On | Off | On |
| 7-1437555-0 | A205SYZQ | DPDT | 6 | (On) | Off | (On) |
| 7-1437555-6 | A207SYZQ | DPDT | 6 | On | Off | (On) |
| 8-1437555-5 | A208SYZQ | DPDT | 2 | On | None | (On) |
| 1437556-1 | A211SYZQ | SP3T | 11 | On | On | On |
| 1437556-4 | A213SYZQ | SP3T | 11 | On | On | (On) |
| 1437556-7 | A215SYZQ | SP3T | 11 | (On) | On | (On) |

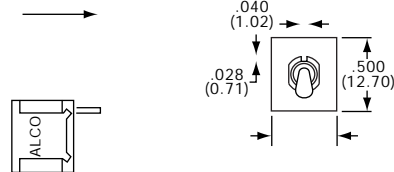

A201SYZQ

Toggle Switches, A Series, PC Terminals, Long Bat Actuators

* Refer to Pages C22-C26 for Additional Options *

SEE PAGE C22 FOR PRODUCT SPECIFICATIONS

SPDT/DPDT



A101SYAB
Horizontal Actuation

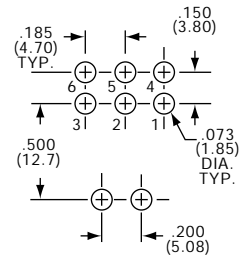
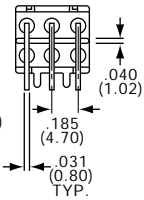
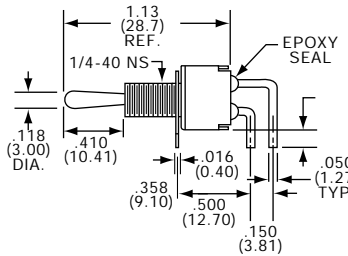
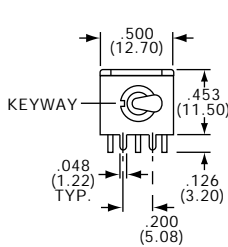
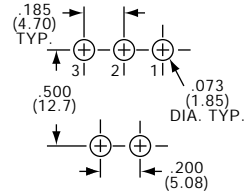
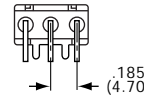
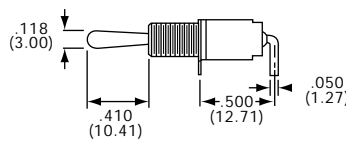
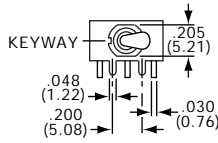

| Tyco Electronics | Alcoswitch | Type | Act. Code | P.M5 | ↘ | ↓ | ↙ |
|----------------------|------------|------|-----------|------|----|------|------|
| Gold Contacts | | | | | | | |
| 4-1437554-3 | A101SYAB | SPDT | 1 | | On | None | On |
| | A103SYAB | SPDT | 5 | | On | Off | On |
| 4-1437555-3 | A201SYAB | DPDT | 2 | | On | None | On |
| | A208SYAB | DPDT | 2 | | On | None | (On) |

SPDT/DPDT



A101SYCB

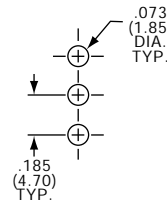
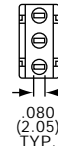
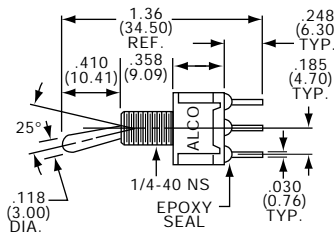
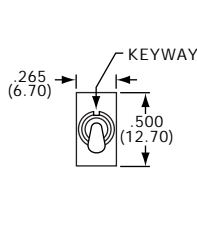

A201SYCB

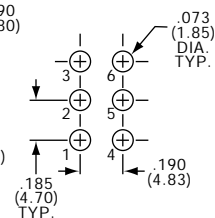
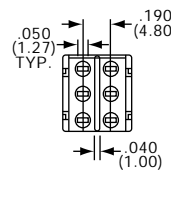
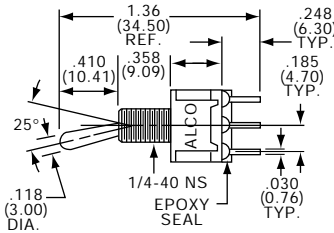
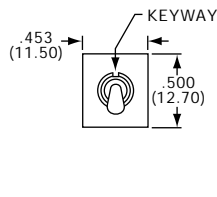

| Tyco Electronics | Alcoswitch | Type | Act. Code | P.M5 | ↘ | ↓ | ↙ |
|----------------------|------------|------|-----------|------|----|------|------|
| Gold Contacts | | | | | | | |
| 4-1437554-5 | A101SYCB | SPDT | 1 | | On | None | On |
| 7-1437554-2 | A103SYCB | SPDT | 5 | | On | Off | On |
| 1-1437555-8 | A108SYCB | SPDT | 1 | | On | None | (On) |
| 4-1437555-5 | A201SYCB | DPDT | 2 | | On | None | On |
| 6-1437555-0 | A203SYCB | DPDT | 6 | | On | Off | On |
| 8-1437555-3 | A208SYCB | DPDT | 2 | | On | None | (On) |

Toggle Switches, A Series, Wire Wrap or Wire Lug, Long Bat Actuators

* Refer to Pages C22-C26 for Additional Options *

SEE PAGE C22 FOR PRODUCT SPECIFICATIONS

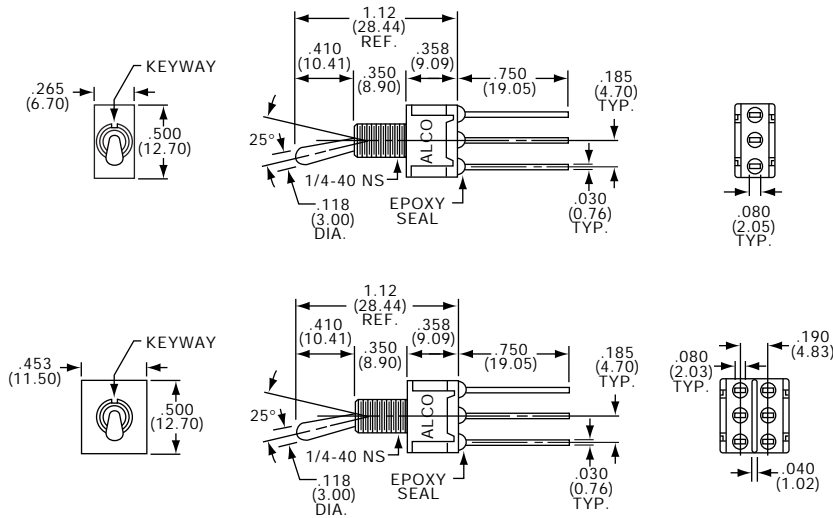

SPDT/DPDT



A101SYWQ

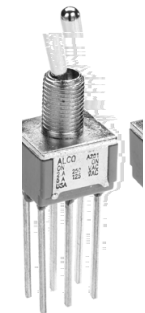

A201SYWQ

G
Gemini Series

| Tyco Electronics | Alcoswitch | Type | Act. Code | P.M5 | | | |
|------------------------|------------|------|-----------|------|------|----|--|
| Silver Contacts | | | | | | | |
| 4-1437554-8 | A101SYWQ | SPDT | 1 | On | None | On | |
| 7-1437554-5 | A103SYWQ | SPDT | 5 | On | Off | On | |
| 4-1437555-7 | A201SYWQ | DPDT | 2 | On | None | On | |
| | A203SYWQ | DPDT | 6 | On | Off | On | |

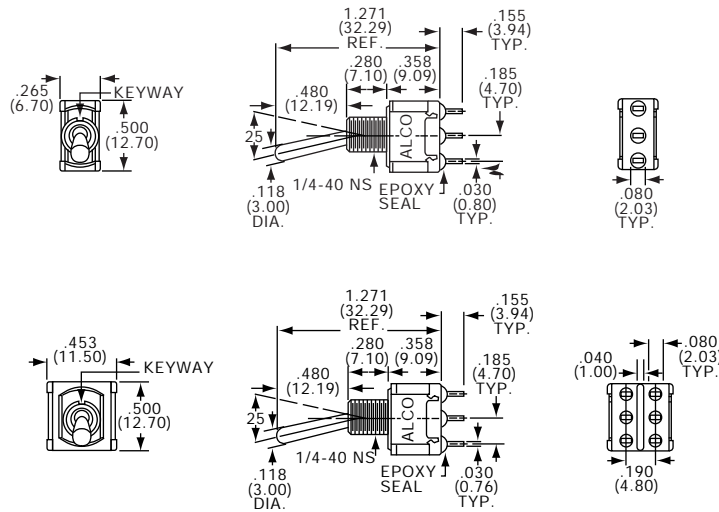

SPDT/DPDT



A101SDZQ



A201SDZQ

| Tyco Electronics | Alcoswitch | Type | Act. Code | P.M5 | | | |
|------------------------|------------|------|-----------|------|------|----|--|
| Silver Contacts | | | | | | | |
| 4-1437554-0 | A101SDZQ | SPDT | 1 | On | None | On | |
| 6-1437554-9 | A103SDZQ | SPDT | 5 | On | Off | On | |
| 4-1437555-1 | A201SDZQ | DPDT | 2 | On | None | On | |
| 5-1437555-9 | A203SDZQ | DPDT | 6 | On | Off | On | |

Toggle Switches, A Series, PC Tail, Straight or Right Angle, Long Bat Actuator

* Refer to Pages C22-C26 for Additional Options *

SEE PAGE C22 FOR PRODUCT SPECIFICATIONS

SPDT



A101SDCQ

DPDT



A201SDCQ

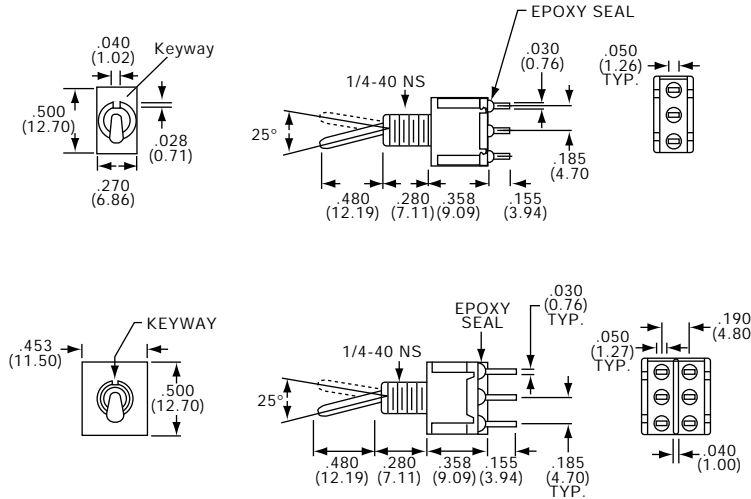

| Tyco Electronics | Alcoswitch | Type | Act. Code | P.M5 | | | |
|------------------------|------------|------|-----------|------|----|------|------|
| Silver Contacts | | | | | | | |
| 3-1437554-9 | A101SDCQ | SPDT | 1 | | On | None | On |
| 6-1437554-8 | A103SDCQ | SPDT | 5 | | On | Off | On |
| 1571670-1 | A201SDCQ | DPDT | 2 | | On | None | On |
| | A203SDCQ | DPDT | 6 | | On | Off | On |
| | A208SDCQ | DPDT | 2 | | On | None | (On) |

SPDT/DPDT



A101SD9AQ

Horizontal Actuation

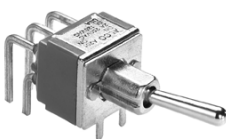
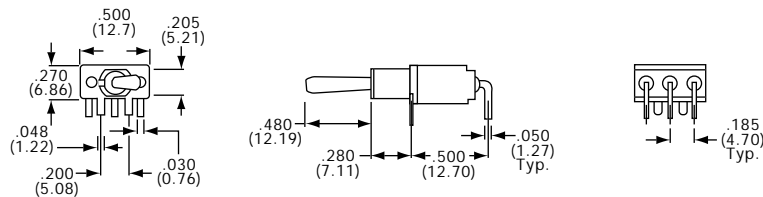

A201SD9AQ

Horizontal Actuation

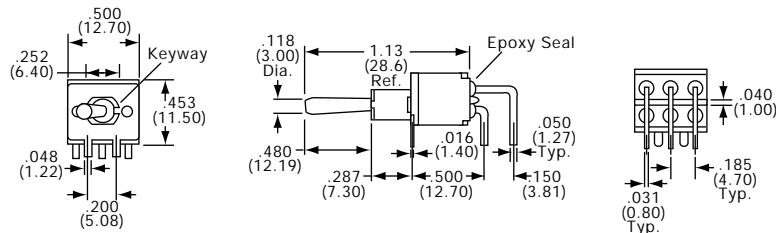

| Tyco Electronics | Alcoswitch | Tyco Electronics | Alcoswitch | Type | Act. Code | P. M5 | | | | |
|------------------------|------------|----------------------|------------|-------------|-----------|-------|----|------|------|----|
| Silver Contacts | | | | | | | | | | |
| 3-1437554-4 | A101SD9AQ | Gold Contacts | | 3-1437554-3 | A101SD9AB | SPDT | 1 | On | None | On |
| 6-1437554-4 | A103SD9AQ | | A103SD9AB | SPDT | 5 | | On | Off | On | |
| 1-1437555-6 | A108SD9AQ | | A108SD9AB | SPDT | 1 | | On | None | (On) | |
| 3-1437555-8 | A201SD9AQ | | A201SD9AB | DPDT | 2 | | On | None | On | |
| 8-1437555-1 | A208SD9AQ | | A208SD9AB | DPDT | 2 | | On | None | (On) | |

Toggle Switches, A Series, Vertical, Right Angle, Long Bat Actuator

* Refer to Pages C22-C26 for Additional Options *

SEE PAGE C22 FOR PRODUCT SPECIFICATIONS

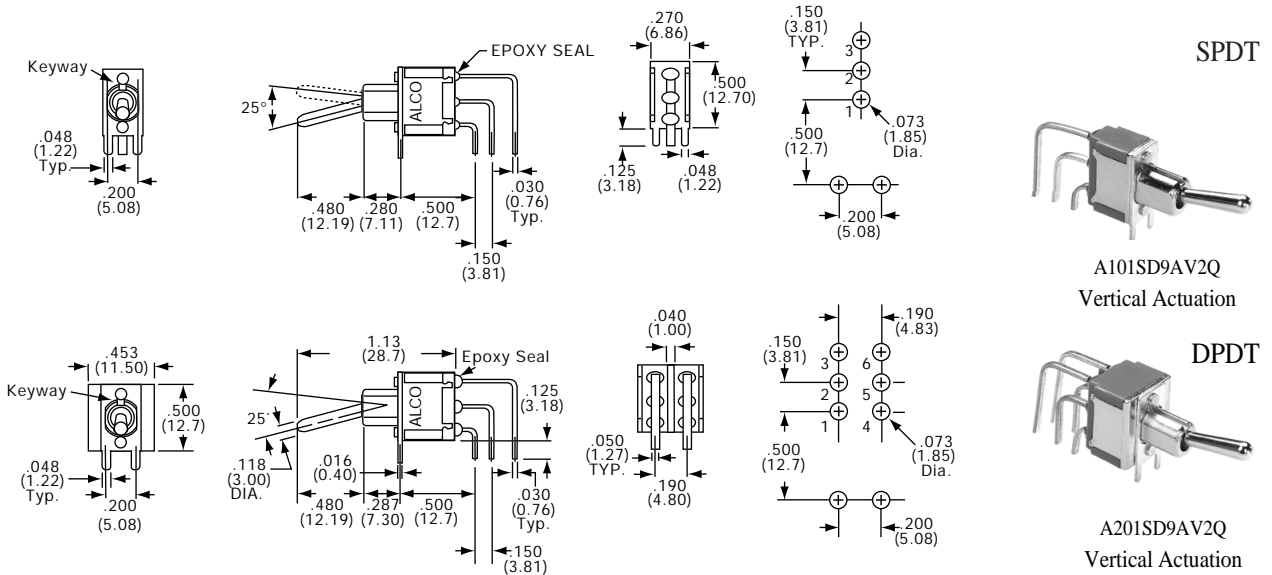

| Tyco Electronics | Alcoswitch | Type | Act. Code | P.M5 | | | | Tyco Electronics | Alcoswitch | Type | Act. Code | P.M5 | | | |
|------------------------|-------------|------|-----------|------|----|------|----|------------------|-------------|------|-----------|------|----|------|------|
| Silver Contacts | | | | | | | | | | | | | | | |
| 3-1437554-6 | A101SD9AV2Q | SPDT | 1 | | On | None | On | 3-1437555-9 | A201SD9AV2Q | DPDT | 2 | | On | None | On |
| 6-1437554-6 | A103SD9AV2Q | SPDT | 5 | | On | Off | On | 5-1437555-8 | A203SD9AV2Q | DPDT | 6 | | On | Off | On |
| | | | | | | | | 8-1437555-2 | A208SD9AV2Q | DPDT | 2 | | On | None | (On) |

Toggle Switches, A Series, Wire Lug, Locking Toggle

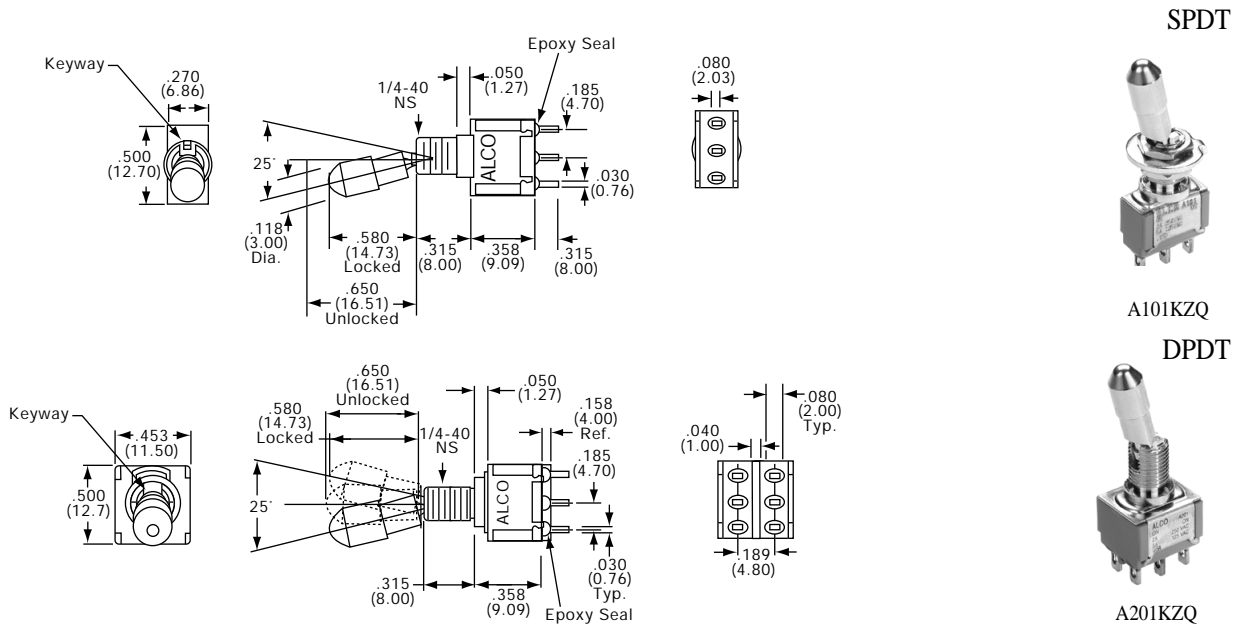

| Tyco Electronics | Alcoswitch | Type | Act. Code | P.M5 | | | | Tyco Electronics | Alcoswitch | Tyco Electronics | Alcoswitch | Type | Act. Code | P.M5 | | | | |
|------------------------|------------|------|-----------|------|----|------|----|----------------------|------------|------------------------|------------|-------------|-----------|------|-----|------|------|----|
| Silver Contacts | | | | | | | | | | | | | | | | | | |
| 1437554-9 | A101KZQ | SPDT | 1 | | On | None | On | Gold Contacts | | Silver Contacts | | 2-1437555-5 | A201KZQ | DPDT | 2 | On | None | On |
| 5-1437554-8 | A103KZQ | SPDT | 5 | | On | Off | On | A203KZB | A203KZB | 5-1437555-3 | A203KZQ | DPDT | 6 | On | Off | On | | |
| | | | | | | | | 6-1437555-5 | A205KZB | | A205KZQ | DPDT | 6 | (On) | Off | (On) | | |
| | | | | | | | | 8-1437555-8 | A211KZB | | A211KZQ | SP3T | 11 | On | On | On | | |

* Refer to Pages C22-C26 for Additional Options *

Toggle Switches, A Series, Right Angle, Short Bat Actuators

SEE PAGE C22 FOR PRODUCT SPECIFICATIONS

SPDT



A101MD9AQ
Horizontal Actuation

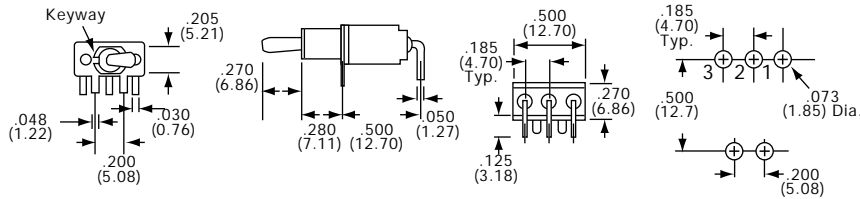

| Tyco Electronics | Alcoswitch | Tyco Electronics | Alcoswitch | Type | Act. Code | P. M5 | ↖ | ↓ | ↗ |
|------------------------|------------|----------------------|------------|------|-----------|-------|----|------|------|
| Silver Contacts | | Gold Contacts | | | | | | | |
| 1-1437554-6 | A101MD9AQ | 1-1437554-4 | A101MD9AB | SPDT | 1 | | On | None | On |
| 6-1437554-1 | A103MD9AQ | 5-1437554-9 | A103MD9AB | SPDT | 5 | | On | Off | On |
| | A108MD9AQ | 1-1437555-2 | A108MD9AB | SPDT | 1 | | On | None | (On) |

DPDT



A201MD9AQ
Horizontal Actuation

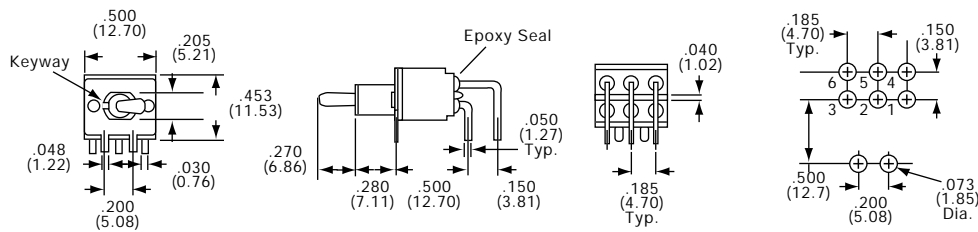

| Tyco Electronics | Alcoswitch | Tyco Electronics | Alcoswitch | Type | Act. Code | P. M5 | ↖ | ↓ | ↗ |
|------------------------|------------|----------------------|------------|------|-----------|-------|----|------|----|
| Silver Contacts | | Gold Contacts | | | | | | | |
| 2-1437555-8 | A201MD9AQ | 2-1437555-7 | A201MD9AB | DPDT | 2 | | On | None | On |
| | | 5-1437555-4 | A203MD9AB | DPDT | 6 | | On | Off | On |

SPDT



A101MD9AV2Q
Vertical Actuation

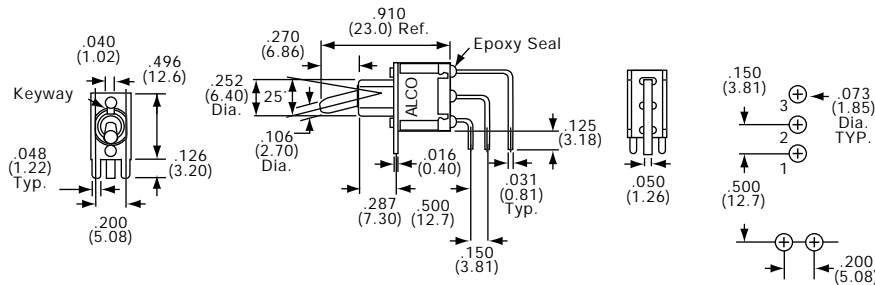

| Tyco Electronics | Alcoswitch | Tyco Electronics | Alcoswitch | Type | Act. Code | P. M5 | ↖ | ↓ | ↗ |
|------------------------|-------------|----------------------|-------------|------|-----------|-------|----|------|------|
| Silver Contacts | | Gold Contacts | | | | | | | |
| 1-1437554-9 | A101MD9AV2Q | 1-1437554-7 | A101MD9AV2B | SPDT | 1 | | On | None | On |
| | A103MD9AV2Q | 6-1437554-2 | A103MD9AV2B | SPDT | 5 | | On | Off | On |
| | A108MD9AV2Q | | | SPDT | 1 | | On | None | (On) |

DPDT

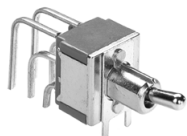

A201MD9AV2AQ
Vertical Actuation

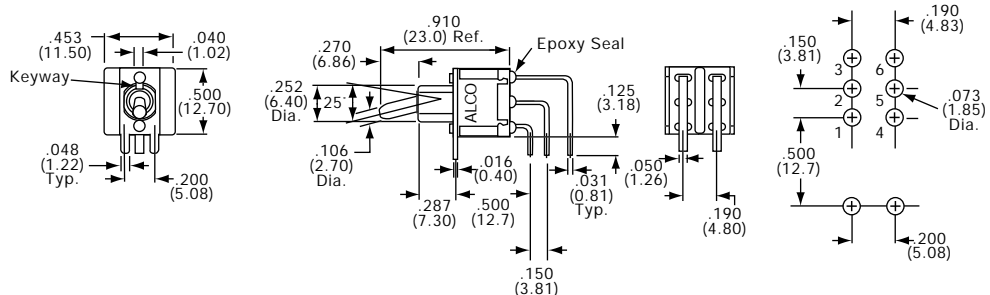

| Tyco Electronics | Alcoswitch | Tyco Electronics | Alcoswitch | Type | Act. Code | P. M5 | ↖ | ↓ | ↗ |
|------------------------|-------------|----------------------|-------------|------|-----------|-------|----|------|------|
| Silver Contacts | | Gold Contacts | | | | | | | |
| 3-1437555-0 | A201MD9AV2Q | 2-1437555-9 | A201MD9AV2B | DPDT | 2 | | On | None | On |
| | A203MD9AV2Q | | A203MD9AV2B | DPDT | 6 | | On | Off | On |
| | A208MD9AV2Q | | A208MD9AV2B | DPDT | 2 | | On | None | (On) |

Toggle Switches, A Series, Vertical, Wire Lug, Flat or Long Bat Actuator

SEE PAGE C22 FOR PRODUCT SPECIFICATIONS

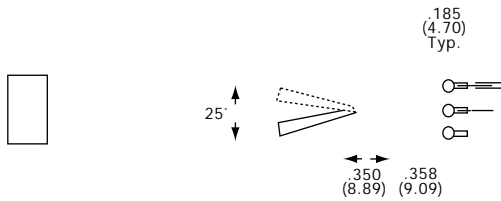

SPDT



A101P3YZQ

| Tyco Electronics | Alcoswitch | Type | Act. Code | P.M5 |
|------------------------|------------|------|-----------|---------------|
| Silver Contacts | | | | |
| 2-1437554-9 | A101P3YZQ | SPDT | 1 | On None On |
| 6-1437554-3 | A103P3YZQ | SPDT | 5 | On Off On |
| 8-1437554-7 | A105P3YZQ | SPDT | 5 | (On) Off (On) |
| 1437555-5 | A107P3YZQ | SPDT | 5 | On Off (On) |
| 1-1437555-5 | A108P3YZQ | SPDT | 1 | On None (On) |

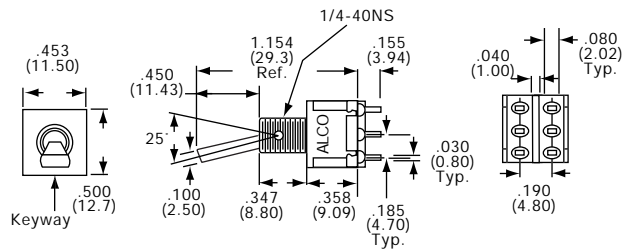

DPDT



A201P3YZQ

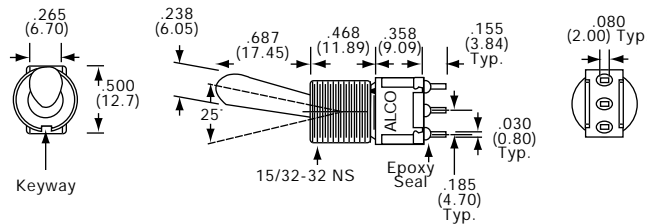

SPDT



A101TZQ

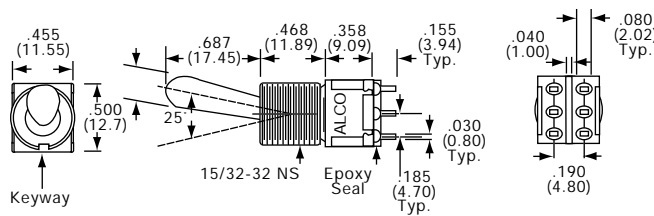

DPDT



A201TZQ

C
Gemini Series

Toggle Switches, A Series, Wire Lug, 15/32 Bushing, Short Bat Actuator

* Refer to Pages C22-C26 for Additional Options *

SEE PAGE C22 FOR PRODUCT SPECIFICATIONS

SPDT



A103T1ZQ

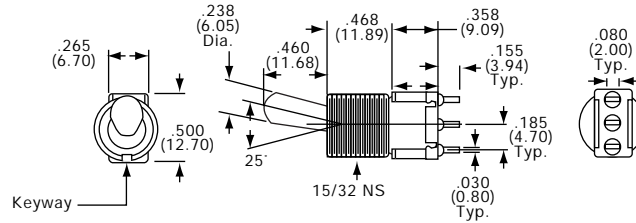

| Tyco Electronics | Alcoswitch | Type | Act. Code | P.M5 | ↘ | ↓ | ↙ |
|------------------------|------------|------|-----------|------|------|------|------|
| Silver Contacts | | | | | | | |
| 5-1437554-4 | A101T1ZQ | SPDT | 1 | | On | None | On |
| 7-1437554-9 | A103T1ZQ | SPDT | 5 | | On | Off | On |
| 9-1437554-8 | A105T1ZQ | SPDT | 5 | | (On) | Off | (On) |
| | A108T1ZQ | SPDT | 1 | | On | None | (On) |

DPDT



A201T1ZQ

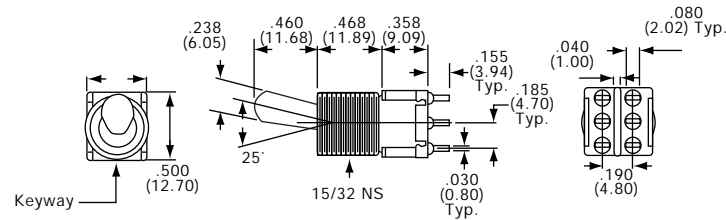

| Tyco Electronics | Alcoswitch | Type | Act. Code | P.M5 | ↘ | ↓ | ↙ |
|------------------------|------------|------|-----------|------|------|------|------|
| Silver Contacts | | | | | | | |
| 5-1437555-0 | A201T1ZQ | DPDT | 2 | | On | None | On |
| 6-1437555-3 | A203T1ZQ | DPDT | 6 | | On | Off | On |
| 7-1437555-1 | A205T1ZQ | DPDT | 6 | | (On) | Off | (On) |
| 7-1437555-7 | A207T1ZQ | DPDT | 6 | | On | Off | (On) |
| 8-1437555-6 | A208T1ZQ | DPDT | 2 | | On | None | (On) |
| 1437556-2 | A211T1ZQ | SP3T | 11 | | On | On | On |



Компания «ЭлектроПласт» предлагает заключение долгосрочных отношений при поставках импортных электронных компонентов на взаимовыгодных условиях!

Наши преимущества:

- Оперативные поставки широкого спектра электронных компонентов отечественного и импортного производства напрямую от производителей и с крупнейших мировых складов;
- Поставка более 17-ти миллионов наименований электронных компонентов;
- Поставка сложных, дефицитных, либо снятых с производства позиций;
- Оперативные сроки поставки под заказ (от 5 рабочих дней);
- Экспресс доставка в любую точку России;
- Техническая поддержка проекта, помощь в подборе аналогов, поставка прототипов;
- Система менеджмента качества сертифицирована по Международному стандарту ISO 9001;
- Лицензия ФСБ на осуществление работ с использованием сведений, составляющих государственную тайну;
- Поставка специализированных компонентов (Xilinx, Altera, Analog Devices, Intersil, Interpoint, Microsemi, Aeroflex, Peregrine, Syfer, Eurofarad, Texas Instrument, Miteq, Cobham, E2V, MA-COM, Hittite, Mini-Circuits, General Dynamics и др.);

Помимо этого, одним из направлений компании «ЭлектроПласт» является направление «Источники питания». Мы предлагаем Вам помощь Конструкторского отдела:

- Подбор оптимального решения, техническое обоснование при выборе компонента;
- Подбор аналогов;
- Консультации по применению компонента;
- Поставка образцов и прототипов;
- Техническая поддержка проекта;
- Защита от снятия компонента с производства.



Как с нами связаться

Телефон: 8 (812) 309 58 32 (многоканальный)

Факс: 8 (812) 320-02-42

Электронная почта: org@eplast1.ru

Адрес: 198099, г. Санкт-Петербург, ул. Калинина, дом 2, корпус 4, литера А.