

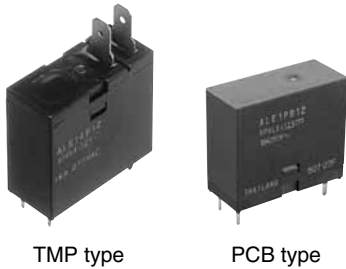

1 Form A 16A power relay for micro wave oven

LE RELAYS (ALE)



TMP type

PCB type

RoHS compliant

Protective construction: Flux-resistant type

FEATURES

1. Supports magnetron and heater loads

Capable for switching magnetron and heater loads found in microwave ovens.

2. Excellent heat resistance

Ambient temperature: up to 85°C 185°F
 Certified UL coil insulation class B and class F

3. High insulation resistance

- Creepage distance and clearances between contact and coil:
 Clearance Min. 8 mm .315 inch
 Creepage Min. 9.5 mm .374 inch
- Surge withstand voltage: 10,000V

4. Low operating power

Nominal operating power: 400mW/200mW (High sensitive type)

5. A wide variety of types

Product line consists of 4 types with different shapes and pins

6. Conforms to the various safety standards:

UL, CSA, TÜV and VDE approved
 UL, CSA and VDE approved (PCB type)

TYPICAL APPLICATIONS

1. Microwave ovens
2. Refrigerators
3. OA equipment

ORDERING INFORMATION



Notes: • Certified by UL, CSA, TÜV and VDE (TMP type).
 • Certified by UL, CSA and VDE (PCB type).

TYPES

1. Standard type

Contact arrangement	Nominal coil voltage	TMP type			PCB type (No tab terminals)
		PCB side three terminals (includes one dummy terminal)	PCB side three terminals	PCB side four terminals	
		Part No.	Part No.	Part No.	
1 Form A	5V DC	ALE12○05	ALE13○05	ALE14○05	ALE1P○05
	6V DC	ALE12○06	ALE13○06	ALE14○06	ALE1P○06
	9V DC	ALE12○09	ALE13○09	ALE14○09	ALE1P○09
	12V DC	ALE12○12	ALE13○12	ALE14○12	ALE1P○12
	18V DC	ALE12○18	ALE13○18	ALE14○18	ALE1P○18
	24V DC	ALE12○24	ALE13○24	ALE14○24	ALE1P○24
	48V DC	ALE12○48	ALE13○48	ALE14○48	ALE1P○48

Standard packing; Carton: 100 pcs. Case 500 pcs.

○: Input the following letter. Class B: B, Class F: F

2. High sensitive type

Contact arrangement	Nominal coil voltage	TMP type			PCB type (No tab terminals)
		PCB side three terminals (includes one dummy terminal)	PCB side three terminals	PCB side four terminals	
		Part No.	Part No.	Part No.	
1 Form A (High sensitivity: 200mW)	5V DC	ALE72○05	ALE73○05	ALE74○05	ALE7P○05
	6V DC	ALE72○06	ALE73○06	ALE74○06	ALE7P○06
	9V DC	ALE72○09	ALE73○09	ALE74○09	ALE7P○09
	12V DC	ALE72○12	ALE73○12	ALE74○12	ALE7P○12
	18V DC	ALE72○18	ALE73○18	ALE74○18	ALE7P○18
	24V DC	ALE72○24	ALE73○24	ALE74○24	ALE7P○24
	48V DC	ALE72○48	ALE73○48	ALE74○48	ALE7P○48

Standard packing; Carton: 100 pcs. Case 500 pcs.

○: Input the following letter. Class B: B, Class F: F

RATING

1. Coil data

1) Standard type

Nominal coil voltage	Pick-up voltage (at 20°C 68°F)	Drop-out voltage (at 20°C 68°F)	Nominal operating current [±10%] (at 20°C 68°F)	Coil resistance [±10%] (at 20°C 68°F)	Nominal operating power (at 20°C 68°F)	Max. applied voltage (at 20°C 68°F)
5V DC	75%V or less of nominal voltage (Initial)	5%V or more of nominal voltage (Initial)	80 mA	63Ω	400mW	7.25V DC
6V DC			66.7mA	90Ω		8.7 V DC
9V DC			44.4mA	203Ω		13.05V DC
12V DC			33.3mA	360Ω		17.4 V DC
18V DC			22.2mA	810Ω		26.1 V DC
24V DC			16.7mA	1,440Ω		34.8 V DC
48V DC			8.3mA	5,760Ω		69.6 V DC

2) High sensitive type

Nominal coil voltage	Pick-up voltage (at 20°C 68°F)	Drop-out voltage (at 20°C 68°F)	Nominal operating current [±10%] (at 20°C 68°F)	Coil resistance [±10%] (at 20°C 68°F)	Nominal operating power (at 20°C 68°F)	Max. applied voltage (at 20°C 68°F)
5V DC	75%V or less of nominal voltage (Initial)	5%V or more of nominal voltage (Initial)	40 mA	125Ω	200mW	7.25V DC
6V DC			33.3mA	180Ω		8.7 V DC
9V DC			22.2mA	405Ω		13.05V DC
12V DC			16.7mA	720Ω		17.4 V DC
18V DC			11.1mA	1,620Ω		26.1 V DC
24V DC			8.3mA	2,880Ω		34.8 V DC
48V DC			4.2mA	11,520Ω		69.6 V DC

2. Specifications

Characteristics	Item	Specifications	
Contact	Arrangement	1 Form A	
	Contact resistance (Initial)	Max. 100 mΩ (By voltage drop 6 V DC 1A)	
	Contact material	AgSnO ₂ type	
Rating	Nominal switching capacity (resistive load)	16A 277V AC	
	Max. switching power (resistive load)	4,432VA	
	Max. switching voltage	277V AC	
	Max. switching current	16A	
	Nominal operating power	400mW (Standard type), 200mW (High sensitive type)	
	Min. switching capacity (reference value)*1	100mA, 5V DC	
	Electrical characteristics	Insulation resistance (Initial)	Min. 1,000MΩ (at 500V DC) Measurement at same location as "Breakdown voltage" section.
Breakdown voltage (Initial)		Between open contacts	1,000 Vrms for 1 min. (Detection current: 10 mA)
		Between contact and coil	4,000 Vrms for 1 min. (Detection current: 10 mA)
Temperature rise (coil)		Max. 55°C 131°F, Max. 45°C 113°F (200mW type) (By resistive method, nominal coil voltage applied to the coil; contact carrying current: 16A, at 20°C 68°F)	
Surge breakdown voltage*2 (Between contact and coil) (Initial)		10,000 V	
Operate time (at nominal voltage) (at 20°C 68°F)		Max. 20 ms (excluding contact bounce time.)	
Release time (at nominal voltage) (at 20°C 68°F)		Max. 20 ms, Max. 25 ms (200mW type) (excluding contact bounce time) (With diode)	
Mechanical characteristics	Shock resistance	Functional	200 m/s ² (Half-wave pulse of sine wave: 11 ms; detection time: 10μs.)
		Destructive	1,000 m/s ² (Half-wave pulse of sine wave: 6 ms.)
	Vibration resistance	Functional	10 to 55 Hz at double amplitude of 1.5 mm (Detection time: 10μs.)
		Destructive	10 to 55 Hz at double amplitude of 1.5 mm
Expected life	Mechanical (at 180 times/min.)	Min. 2×10 ⁶	
	Electrical (at 20 times/min.)	Min. 10 ⁵ (at resistive load)	
Conditions	Conditions for operation, transport and storage*3	Ambient temperature: -40°C to +85°C -40°F to +185°F; Humidity: 5 to 85% R.H. (Not freezing and condensing at low temperature)	
	Max. operating speed	20 times/min. (at nominal switching capacity)	
Unit weight		Approx. 17 g .60 oz, Approx. 15 g .53 oz (PCB type)	

* Specifications will vary with foreign standards certification ratings.

Notes: *1. This value can change due to the switching frequency, environmental conditions, and desired reliability level, therefore it is recommended to check this with the actual load.

*2. Wave is standard shock voltage of ±1.2×50μs according to JEC-212-1981

*3. The upper limit of the ambient temperature is the maximum temperature that can satisfy the coil temperature rise value. Refer to Usage, transport and storage conditions in NOTES.

REFERENCE DATA

1.-(1) Coil temperature rise (400mW type)

Sample: ALE14B12, 6 pcs.
Point measured: coil inside
Ambient temperature: 25°C 77°F, 85°C 185°F

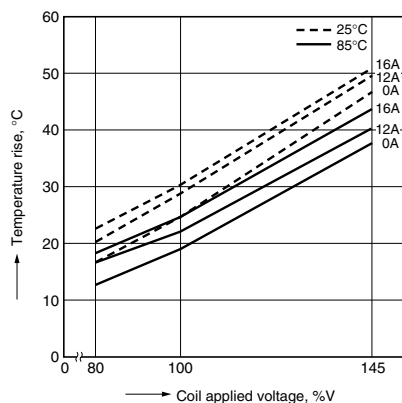

1.-(2) Coil temperature rise (200mW type)

Sample: ALE74B12, 6 pcs.
Point measured: coil inside
Ambient temperature: 23.7°C 74.66°F, 85°C 185°F

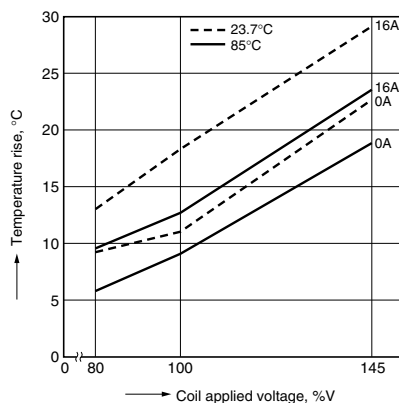

2. Life curve

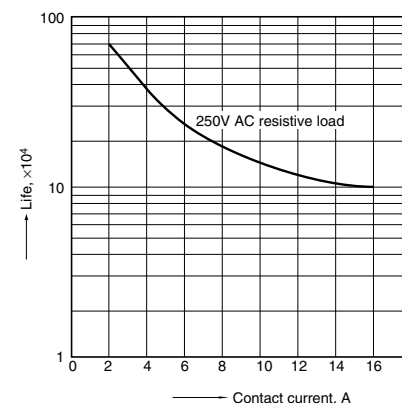

LE (ALE)

3. Electrical life test (16 A 277 V AC, resistive load)

Sample: ALE14B12, 6 pcs.

Operation frequency: 20 times/min.

(ON/OFF = 1.5s: 1.5s)

Ambient temperature: Room temperature

Circuit:



DIMENSIONS (mm inch)

The CAD data of the products with a **CAD Data** mark can be downloaded from: <http://industrial.panasonic.com/ac/e/>

1. TMP type

1) PCB side three terminals
(includes one dummy terminal)

CAD Data



External dimensions



Dimension:
 Less than 1mm .039inch: $\pm 0.1 \pm 0.004$
 Min. 1mm .039inch
 less than 3mm .118 inch: $\pm 0.2 \pm 0.008$
 Min. 3mm .118 inch: $\pm 0.3 \pm 0.012$

Tolerance
 Less than 1mm .039inch: $\pm 0.1 \pm 0.004$
 Min. 1mm .039inch
 less than 3mm .118 inch: $\pm 0.2 \pm 0.008$
 Min. 3mm .118 inch: $\pm 0.3 \pm 0.012$

PC board pattern (Bottom view)

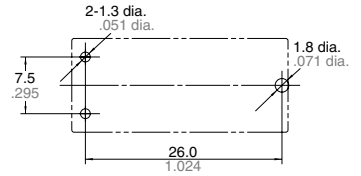

Tolerance: $\pm 0.1 \pm 0.004$

Schematic (Bottom view)

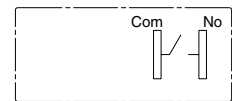

2) PCB side three terminals

CAD Data

External dimensions



Dimension:
 Less than 1mm .039inch: $\pm 0.1 \pm 0.004$
 Min. 1mm .039inch
 less than 3mm .118 inch: $\pm 0.2 \pm 0.008$
 Min. 3mm .118 inch: $\pm 0.3 \pm 0.012$

Tolerance
 Less than 1mm .039inch: $\pm 0.1 \pm 0.004$
 Min. 1mm .039inch
 less than 3mm .118 inch: $\pm 0.2 \pm 0.008$
 Min. 3mm .118 inch: $\pm 0.3 \pm 0.012$

PC board pattern (Bottom view)

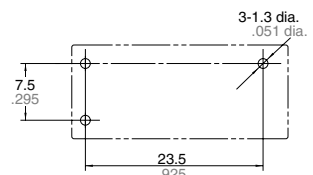

Tolerance: $\pm 0.1 \pm 0.004$

Schematic (Bottom view)

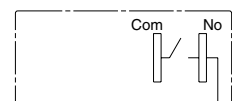

3) PCB side four terminals

CAD Data

External dimensions



PC board pattern (Bottom view)

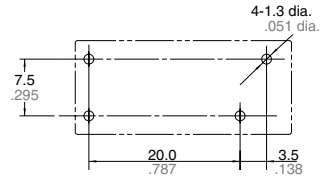

Tolerance: $\pm 0.1 \pm 0.004$

Schematic (Bottom view)

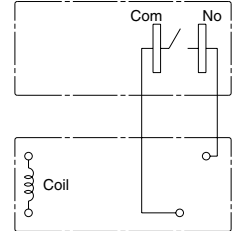

Dimension:
 Less than 1mm .039inch: $\pm 0.1 \pm 0.004$
 Min. 1mm .039inch
 less than 3mm .118 inch: $\pm 0.2 \pm 0.008$
 Min. 3mm .118 inch: $\pm 0.3 \pm 0.012$

Tolerance

2. PCB type

(No tab terminals)

CAD Data



External dimensions

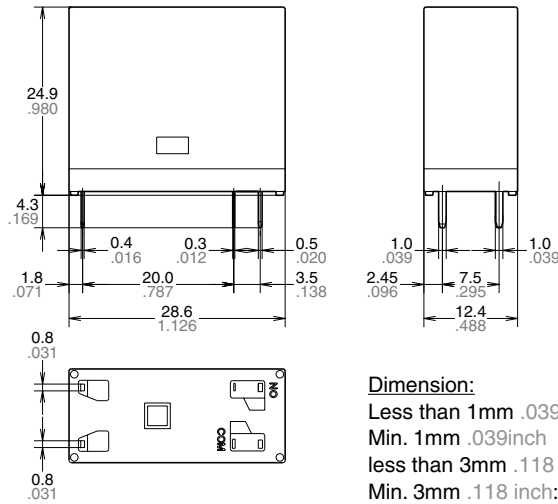

PC board pattern (Bottom view)

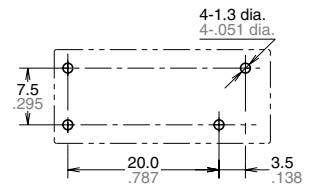

Tolerance: $\pm 0.1 \pm 0.004$

Schematic (Bottom view)



Dimension:
 Less than 1mm .039inch: $\pm 0.1 \pm 0.004$
 Min. 1mm .039inch
 less than 3mm .118 inch: $\pm 0.2 \pm 0.008$
 Min. 3mm .118 inch: $\pm 0.3 \pm 0.012$

Tolerance

SAFETY STANDARDS

UL/C-UL (Recognized)		CSA (Certified)		VDE (Certified)		TV rating (UL/CSA)		TÜV (Certified)	
File No.	Contact rating	File No.	Contact rating	File No.	Contact rating	File No.	Rating	File No.	Rating
E43149	16A 277V AC 16A 30V DC 18A 125V AC	LR26550	16A 277V AC 16A 30V DC 18A 125V AC	40009159	16A 250V AC (cosφ=1.0) 16A 30V DC (0ms)	UL E43149 CSA LR26550	TV-5	B 12 06 13461 325	16A 250V AC (cosφ=1.0) 16A 30V DC (0ms)

NOTES

1. For cautions for use, please read "GENERAL APPLICATION GUIDELINES" on page B-1.

Mouser Electronics

Authorized Distributor

Click to View Pricing, Inventory, Delivery & Lifecycle Information:

Panasonic:

[ALE75B05](#) [ALE75B06](#) [ALE75B09](#) [ALE75B12](#) [ALE75B18](#) [ALE75B24](#) [ALE75B48](#) [ALE75F05](#) [ALE75F06](#)
[ALE75F09](#) [ALE75F12](#) [ALE75F18](#) [ALE75F24](#) [ALE75F48](#) [ALE14B05](#) [ALE14B06](#) [ALE14B09](#) [ALE14B12](#) [ALE14B24](#)
[ALE14B48](#) [ALE15B12](#) [ALE15B24](#) [ALE12B05](#) [ALE12B06](#) [ALE12B09](#) [ALE12B12](#) [ALE12B18](#) [ALE12B24](#)
[ALE12B48](#) [ALE12F05](#) [ALE12F06](#) [ALE12F09](#) [ALE12F12](#) [ALE12F18](#) [ALE12F24](#) [ALE12F48](#) [ALE13B05](#) [ALE13B06](#)
[ALE13B09](#) [ALE13B12](#) [ALE13B18](#) [ALE13B24](#) [ALE13B48](#) [ALE13F05](#) [ALE13F06](#) [ALE13F09](#) [ALE13F12](#)
[ALE13F18](#) [ALE13F24](#) [ALE13F48](#) [ALE14B18](#) [ALE14F05](#) [ALE14F06](#) [ALE14F09](#) [ALE14F12](#) [ALE14F18](#) [ALE14F24](#)
[ALE14F48](#) [ALE72B05](#) [ALE72B06](#) [ALE72B09](#) [ALE72B12](#) [ALE72B18](#) [ALE72B24](#) [ALE72B48](#) [ALE72F05](#) [ALE72F06](#)
[ALE72F09](#) [ALE72F12](#) [ALE72F18](#) [ALE72F24](#) [ALE72F48](#) [ALE73B05](#) [ALE73B06](#) [ALE73B09](#) [ALE73B12](#)
[ALE73B18](#) [ALE73B24](#) [ALE73B48](#) [ALE73F05](#) [ALE73F06](#) [ALE73F09](#) [ALE73F12](#) [ALE73F18](#) [ALE73F24](#) [ALE73F48](#)
[ALE74B05](#) [ALE74B06](#) [ALE74B09](#) [ALE74B12](#) [ALE74B18](#) [ALE74B24](#) [ALE74B48](#) [ALE74F05](#) [ALE74F06](#)
[ALE74F09](#) [ALE74F12](#) [ALE74F18](#) [ALE74F24](#) [ALE74F48](#)



Компания «ЭлектроПласт» предлагает заключение долгосрочных отношений при поставках импортных электронных компонентов на взаимовыгодных условиях!

Наши преимущества:

- Оперативные поставки широкого спектра электронных компонентов отечественного и импортного производства напрямую от производителей и с крупнейших мировых складов;
- Поставка более 17-ти миллионов наименований электронных компонентов;
- Поставка сложных, дефицитных, либо снятых с производства позиций;
- Оперативные сроки поставки под заказ (от 5 рабочих дней);
- Экспресс доставка в любую точку России;
- Техническая поддержка проекта, помощь в подборе аналогов, поставка прототипов;
- Система менеджмента качества сертифицирована по Международному стандарту ISO 9001;
- Лицензия ФСБ на осуществление работ с использованием сведений, составляющих государственную тайну;
- Поставка специализированных компонентов (Xilinx, Altera, Analog Devices, Intersil, Interpoint, Microsemi, Aeroflex, Peregrine, Syfer, Eurofarad, Texas Instrument, Miteq, Cobham, E2V, MA-COM, Hittite, Mini-Circuits, General Dynamics и др.);

Помимо этого, одним из направлений компании «ЭлектроПласт» является направление «Источники питания». Мы предлагаем Вам помощь Конструкторского отдела:

- Подбор оптимального решения, техническое обоснование при выборе компонента;
- Подбор аналогов;
- Консультации по применению компонента;
- Поставка образцов и прототипов;
- Техническая поддержка проекта;
- Защита от снятия компонента с производства.



Как с нами связаться

Телефон: 8 (812) 309 58 32 (многоканальный)

Факс: 8 (812) 320-02-42

Электронная почта: org@eplast1.ru

Адрес: 198099, г. Санкт-Петербург, ул. Калинина, дом 2, корпус 4, литера А.