

ISL28006

Micropower, Rail to Rail Input Current Sense Amplifier with Voltage Output

FN6548
Rev 6.00
November 22, 2013

The ISL28006 is a micropower, uni-directional high-side and low-side current sense amplifier featuring a proprietary rail-to-rail input current sensing amplifier. The ISL28006 is ideal for high-side current sense applications where the sense voltage is usually much higher than the amplifier supply voltage. The device can be used to sense voltages as high as 28V when operating from a supply voltage as low as 2.7V. The micropower ISL28006 consumes only 50µA of supply current when operating from a 2.7V to 28V supply.

The ISL28006 features a common-mode input voltage range from 0V to 28V. The proprietary architecture extends the input voltage sensing range down to 0V, making it an excellent choice for low-side ground sensing applications. The benefit of this architecture is that a high degree of total output accuracy is maintained over the entire 0V to 28V common mode input voltage range.

The ISL28006 is available in fixed (100V/V, 50V/V, 20V/V and Adjustable) gains in the space saving 5 Ld SOT-23 package and the 6 Ld SOT-23 package for the adjustable gain part. The parts operate over the extended temperature range from -40°C to +125°C.

Features

- Low Power Consumption..... 50µA, Typ
- Supply Range2.7V to 28V
- Wide Common Mode Input..... 0V to 28V
- Gain Versions
 - ISL28006-100 100V/V
 - ISL28006-50 50V/V
 - ISL28006-20 20V/V
 - ISL28006-ADJ ADJ (Min Gain = 20V/V)
- Operating Temperature Range.....-40°C to +125°C
- Packages.....5 Ld SOT-23, 6 Ld SOT-23

Applications

- Power Management/Monitors
- Power Distribution and Safety
- DC/DC, AC/DC Converters
- Battery Management/Charging
- Automotive Power Distribution

Related Literature

- See [AN1532](#) for “ISL28006 Evaluation Board User’s Guide”



FIGURE 1. TYPICAL APPLICATION

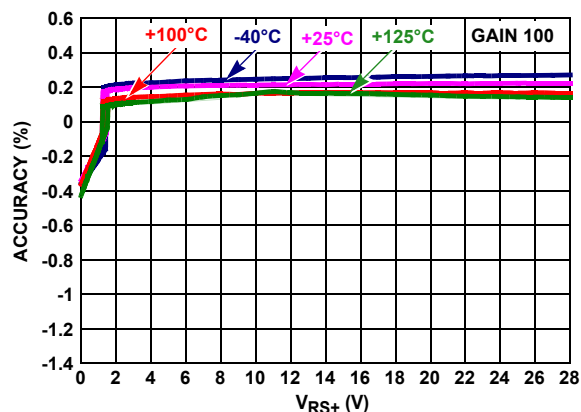
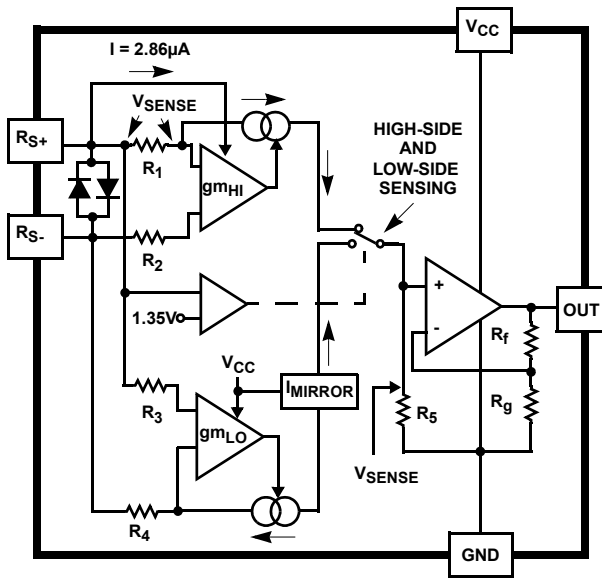

FIGURE 2. GAIN ACCURACY vs V_{RS+} = 0V TO 28V

Block Diagram



FIXED GAIN PARTS



ADJUSTABLE GAIN PART

Pin Configurations

ISL28006-100, 50, 20
(5 LD SOT-23)
TOP VIEW

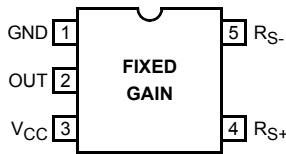

ISL28006-ADJ
(6 LD SOT-23)
TOP VIEW

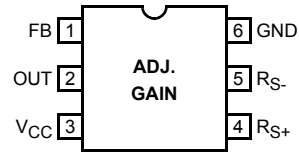

Pin Descriptions

ISL28006-100, 50, 20 (5 LD SOT-23)	ISL28006-ADJ (6 LD SOT-23)	PIN NAME	DESCRIPTION
1	6	GND	Power Ground
	1	FB	Input Pin for External Resistors
2	2	OUT	Amplifier Output
3	3	VCC	Positive Power Supply
4	4	RS+	Sense Voltage Non-inverting Input
5	5	RS-	Sense Voltage Inverting Input



Ordering Information

PART NUMBER (Notes 1, 2, 3)	GAIN	PART MARKING	PACKAGE Tape & Reel (Pb-Free)	PKG. DWG. #
ISL28006FH100Z-T7	100V/V	BDJA (Note 4)	5 Ld SOT-23	P5.064A
ISL28006FH100Z-T7A	100V/V	BDJA (Note 4)	5 Ld SOT-23	P5.064A
ISL28006FH50Z-T7	50V/V	BDHA (Note 4)	5 Ld SOT-23	P5.064A
ISL28006FH50Z-T7A	50V/V	BDHA (Note 4)	5 Ld SOT-23	P5.064A
ISL28006FH20Z-T7	20V/V	BDGA (Note 4)	5 Ld SOT-23	P5.064A
ISL28006FH20Z-T7A	20V/V	BDGA (Note 4)	5 Ld SOT-23	P5.064A
ISL28006FHADJZ-T7	ADJ	BDFA (Note 4)	6 Ld SOT-23	P6.064
ISL28006FHADJZ-T7A	ADJ	BDFA (Note 4)	6 Ld SOT-23	P6.064
ISL28006FH-100EVAL1Z	100V/V Evaluation Board			
ISL28006FH-50EVAL1Z	50V/V Evaluation Board			
ISL28006FH-20EVAL1Z	20V/V Evaluation Board			
ISL28006FH-ADJEVAL1Z	Adjustable Evaluation Board			

NOTES:

1. Please refer to [TB347](#) for details on reel specifications.
2. These Intersil Pb-free plastic packaged products employ special Pb-free material sets, molding compounds/die attach materials, and 100% matte tin plate plus anneal (e3 termination finish, which is RoHS compliant and compatible with both SnPb and Pb-free soldering operations). Intersil Pb-free products are MSL classified at Pb-free peak reflow temperatures that meet or exceed the Pb-free requirements of IPC/JEDEC J STD-020.
3. For Moisture Sensitivity Level (MSL), please see device information page for [ISL28006](#). For more information on MSL please see techbrief [TB363](#).
4. The part marking is located on the bottom of the part.

Absolute Maximum Ratings

Max Supply Voltage	28V
Max Differential Input Current	20mA
Max Differential Input Voltage	±0.5V
Max Input Voltage (R _{S+} , R _{S-} , FB)	GND - 0.5V to 30V
Max Input Current for Input Voltage <GND - 0.5V	±20mA
Output Short-Circuit Duration	Indefinite
Di-Electrically Isolated PR40 Process	Latch-up free
ESD Rating	
Human Body Model (Tested per JESD22-A114F)	4kV
Machine Model (Tested per EIA/JESD22-A115-A)	200V
Charged Device Model (Tested per JESD22-C101D)	1.5kV

Thermal Information

Thermal Resistance (Typical)	θ_{JA} (°C/W)	θ_{JC} (°C/W)
5 Ld SOT-23 (Notes 5, 6)	190	90
6 Ld SOT-23 (Notes 5, 6)	180	90
Maximum Storage Temperature Range	-65°C to +150°C	
Maximum Junction Temperature (T _{JMAX})	+150°C	
Pb-Free Reflow Profile	see link below	
	http://www.intersil.com/pbfree/Pb-FreeReflow.asp	

Recommended Operating Conditions

Ambient Temperature Range (T _A)	-40°C to +125°C
---	-----------------

CAUTION: Do not operate at or near the maximum ratings listed for extended periods of time. Exposure to such conditions may adversely impact product reliability and result in failures not covered by warranty.

NOTES:

- θ_{JA} is measured with the component mounted on a high effective thermal conductivity test board in free air. See Tech Brief TB379 for details.
- For θ_{JC} , the "case temp" location is taken at the package top center.

Electrical Specifications $V_{CC} = 12V$, $V_{RS+} = 0V$ to 28V, $V_{SENSE} = 0V$, $R_{LOAD} = 1M\Omega$, $T_A = +25^\circ C$ unless otherwise specified.
Boldface limits apply over the operating temperature range, -40°C to +125°C. Temperature data established by characterization.

PARAMETER	DESCRIPTION	CONDITIONS	MIN (Note 7)	TYP	MAX (Note 7)	UNIT
V _{OS} (Input Offset Voltage)	Gain = 100 (Notes 8, 9)	V _{CC} = V _{RS+} = 12V, V _{SENSE} = 20mV to 100mV	-250	60	250	μV
			-300		300	μV
	V _{CC} = 12V, V _{RS+} = 0.2V, V _{SENSE} = 20mV to 100mV	-2.5	-1.2	2.5	mV	
		-2.8		2.8	mV	
	Gain = 50, Gain = 20 (Notes 8, 9)	V _{CC} = V _{RS+} = 12V, V _{SENSE} = 20mV to 100mV	-300	60	300	μV
			-450		450	μV
V _{CC} = 12V, V _{RS+} = 0.2V, V _{SENSE} = 20mV to 100mV	-2.8	-1.2	2.8	mV		
	-3.2		3.2	mV		
Adjustable, Gain = 21 R _f = 100kΩ, R _g = 5kΩ (Notes 8, 9)	V _{CC} = V _{RS+} = 12V, V _{SENSE} = 20mV to 100mV	-300	60	300	μV	
		-450		450	μV	
	V _{CC} = 12V, V _{RS+} = 0.2V, V _{SENSE} = 20mV to 100mV	-3.1	-1.2	3.1	mV	
		-3.4		3.4	mV	
I _{RS+} , I _{RS-}	Leakage Current	V _{CC} = 0V, V _{RS+} = 28V		0.041	1.2	μA
					1.5	μA
I _{RS+} (+ Input Bias Current)	Gain = 100	V _{RS+} = 2V, V _{SENSE} = 5mV		4.7	6	μA
					7	μA
	V _{RS+} = 0V, V _{SENSE} = 5mV	-500	-432		nA	
		-600			nA	
	Gain = 50, Gain = 20	V _{RS+} = 2V, V _{SENSE} = 5mV		4.7	6	μA
					8	μA
	V _{RS+} = 0V, V _{SENSE} = 5mV	-700	-432		nA	
		-840			nA	
	ADJ Gain = 101 R _f = 100kΩ, R _g = 1kΩ	V _{RS+} = 2V, V _{SENSE} = 5mV		4.7	6	μA
					7	μA
V _{RS+} = 0V, V _{SENSE} = 5mV	-500	-432		nA		
	-600			nA		

Electrical Specifications $V_{CC} = 12V$, $V_{RS+} = 0V$ to $28V$, $V_{SENSE} = 0V$, $R_{LOAD} = 1M\Omega$, $T_A = +25^\circ C$ unless otherwise specified.
Boldface limits apply over the operating temperature range, $-40^\circ C$ to $+125^\circ C$. Temperature data established by characterization. (Continued)

PARAMETER	DESCRIPTION	CONDITIONS	MIN (Note 7)	TYP	MAX (Note 7)	UNIT
I_{RS-} (- Input Bias Current)	G = 100, 50, 20, ADJ	$V_{RS+} = 2V$, $V_{SENSE} = 5mV$		5	50	nA
					75	nA
		$V_{RS+} = 0V$, $V_{SENSE} = 5mV$	-125	-45		nA
			-130			nA
CMRR	Common Mode Rejection Ratio	$V_{RS+} = 2V$ to $28V$	105	115		dB
PSRR	Power Supply Rejection Ratio	$V_{CC} = 2.7V$ to $28V$, $V_{RS+} = 2V$	90	105		dB
V_{FS}	Full-scale Sense Voltage	$V_{CC} = 28V$, $V_{RS+} = 0.2V$, $12V$	200			mV
G (Gain)	(Note 8)	ISL28006-100		100		V/V
		ISL28006-50		50		V/V
		ISL28006-20		20		V/V
		ISL28006-ADJ	20			V/V
G_A (Gain Accuracy)	Gain = 100 (Note 10)	$V_{CC} = V_{RS+} = 12V$, $V_{SENSE} = 20mV$ to $100mV$	-0.2		0.7	%
			-1		1	%
	Gain = 50, Gain = 20 (Note 10)	$V_{CC} = V_{RS+} = 12V$, $V_{SENSE} = 20mV$ to $100mV$	-0.35		0.7	%
			-1		1	%
		$V_{CC} = 12V$, $V_{RS+} = 0.1V$, $V_{SENSE} = 20mV$ to $100mV$	-2.2	-0.33	2.2	%
			-2.3		2.3	%
	ADJ Gain = 21 $R_f = 100k\Omega$, $R_g = 5k\Omega$ (Note 10)	$V_{CC} = V_{RS+} = 12V$, $V_{SENSE} = 20mV$ to $100mV$	-0.65		1	%
			-1		1.05	%
V_{OA} (Total Output Accuracy)	Gain = 100 (Note 11)	$V_{CC} = V_{RS+} = 12V$, $V_{SENSE} = 100mV$	-0.7		0.7	%
			-0.9		0.9	%
	Gain = 50, Gain = 20 (Note 11)	$V_{CC} = 12V$, $V_{RS+} = 0.1V$, $V_{SENSE} = 100mV$		-1.25		%
			-0.7		0.7	%
		$V_{CC} = 12V$, $V_{RS+} = 0.1V$, $V_{SENSE} = 100mV$	-0.9		0.9	%
			-4.7	-1.41	1.8	%
ADJ Gain = 21 $R_f = 100k\Omega$, $R_g = 5k\Omega$ (Note 11)	$V_{CC} = V_{RS+} = 12V$, $V_{SENSE} = 100mV$	-5.2		2.3	%	
		-0.7		1.05	%	
	$V_{CC} = 12V$, $V_{RS+} = 0.1V$, $V_{SENSE} = 100mV$	-0.9		1.2	%	
		-4.7	-1.41	1.8	%	
V_{OH}	Output Voltage Swing, High $V_{CC} - V_{OUT}$	$I_O = -500\mu A$, $V_{CC} = 2.7V$, $V_{SENSE} = 100mV$, $V_{RS+} = 2V$		39	50	mV
V_{OL}	Output Voltage Swing, Low V_{OUT}	$I_O = 500\mu A$, $V_{CC} = 2.7V$, $V_{SENSE} = 0V$, $V_{RS+} = 2V$		30	50	mV
R_{OUT}	Output Resistance	$V_{CC} = V_{RS+} = 12V$, $V_{SENSE} = 100mV$, $I_{OUT} = 10\mu A$ to $1mA$		6.5		Ω
I_{SC+}	Short Circuit Sourcing Current	$V_{CC} = V_{RS+} = 5V$, $R_L = 10\Omega$		4.8		mA
I_{SC-}	Short Circuit Sinking Current	$V_{CC} = V_{RS+} = 5V$, $R_L = 10\Omega$		8.7		mA

Electrical Specifications $V_{CC} = 12V$, $V_{RS+} = 0V$ to $28V$, $V_{SENSE} = 0V$, $R_{LOAD} = 1M\Omega$, $T_A = +25^\circ C$ unless otherwise specified.
Boldface limits apply over the operating temperature range, $-40^\circ C$ to $+125^\circ C$. Temperature data established by characterization. (Continued)

PARAMETER	DESCRIPTION	CONDITIONS	MIN (Note 7)	TYP	MAX (Note 7)	UNIT
I _{CC}	Gain = 100	$V_{RS+} > 2V$, $V_{SENSE} = 5mV$		50	59	μA
					62	μA
	Gain = 50, 20,	$V_{RS+} > 2V$, $V_{SENSE} = 5mV$		50	62	μA
					63	μA
	ADJ Gain = 21 $R_f = 100k\Omega$, $R_g = 5k\Omega$	$V_{RS+} > 2V$, $V_{SENSE} = 5mV$		50	62	μA
					63	μA
V _{CC}	Supply Voltage	Guaranteed by PSRR	2.7		28	V
Slew Rate	Gain = 100	Pulse on R_{S+} pin, $V_{OUT} = 8V_{P-P}$ (Figure 75)	0.58	0.76		V/ μs
	Gain = 50	Pulse on R_{S+} pin, $V_{OUT} = 8V_{P-P}$ (Figure 75)	0.58	0.67		V/ μs
	Gain = 20	Pulse on R_{S+} pin, $V_{OUT} = 3.5V_{P-P}$ (Figure 75)	0.50	0.67		V/ μs
	ADJ Gain = 21 $R_f = 100k\Omega$, $R_g = 5k\Omega$	Pulse on R_{S+} pin, $V_{OUT} = 3.5V_{P-P}$ (Figure 75)	0.50	0.67		V/ μs
BW _{-3dB}	Gain = 100	$V_{RS+} = 12V$, $0.1V$, $V_{SENSE} = 100mV$		110		kHz
	Gain = 50	$V_{RS+} = 12V$, $0.1V$, $V_{SENSE} = 100mV$		160		kHz
	Gain = 20	$V_{RS+} = 12V$, $0.1V$, $V_{SENSE} = 100mV$		180		kHz
	ADJ, Gain = 101 (Figure 65)	$V_{RS+} = 12V$, $0.1V$, $V_{SENSE} = 100mV$, $R_f = 100k\Omega$, $R_g = 1k\Omega$		40		kHz
	ADJ, Gain = 51 (Figure 65)	$V_{RS+} = 12V$, $V_{SENSE} = 100mV$, $R_f = 100k\Omega$, $R_g = 2k\Omega$		78		kHz
		$V_{RS+} = 0.1V$, $V_{SENSE} = 100mV$, $R_f = 100k\Omega$, $R_g = 2k\Omega$		122		kHz
	ADJ, Gain = 21 (Figure 65)	$V_{RS+} = 12V$, $V_{SENSE} = 100mV$, $R_f = 100k\Omega$, $R_g = 5k\Omega$		131		kHz
$V_{RS+} = 0.1V$, $V_{SENSE} = 100mV$, $R_f = 100k\Omega$, $R_g = 5k\Omega$			237		kHz	
t _S	Output Settling Time to 1% of Final Value	$V_{CC} = V_{RS+} = 12V$, $V_{OUT} = 10V$ step, $V_{SENSE} > 7mV$		15		μs
		$V_{CC} = V_{RS+} = 0.2V$, $V_{OUT} = 10V$ step, $V_{SENSE} > 7mV$		20		μs
	Capacitive-Load Stability	No sustained oscillations		300		pF
t _S Power-up	Power-Up Time to 1% of Final Value	$V_{CC} = V_{RS+} = 12V$, $V_{SENSE} = 100mV$		15		μs
		$V_{CC} = 12V$, $V_{RS+} = 0.2V$, $V_{SENSE} = 100mV$		50		μs
	Saturation Recovery Time	$V_{CC} = V_{RS+} = 12V$, $V_{SENSE} = 100mV$, overdrive		10		μs

NOTES:

7. Compliance to datasheet limits is assured by one or more methods: production test, characterization and/or design.

8. DEFINITION OF TERMS:

- $V_{SENSE A} = V_{SENSE} @ 100mV$
- $V_{SENSE B} = V_{SENSE} @ 20mV$
- $V_{OUT A} = V_{OUT} @ V_{SENSE A} = 100mV$
- $V_{OUT B} = V_{OUT} @ V_{SENSE B} = 20mV$

$$G = \text{GAIN} = \left(\frac{V_{OUT A} - V_{OUT B}}{V_{SENSE A} - V_{SENSE B}} \right)$$

9. V_{OS} is extrapolated from the gain measurement. $V_{OS} = V_{SENSE A} - \frac{V_{OUT A}}{G}$

$$10. \% \text{ Gain Accuracy} = G_A = \left(\frac{G_{MEASURED} - G_{EXPECTED}}{G_{EXPECTED}} \right) \times 100$$

$$11. \text{ Output Accuracy \% } VOA = \left(\frac{V_{OUT, MEASURED} - V_{OUT, EXPECTED}}{V_{OUT, EXPECTED}} \right) \times 100, \text{ where } V_{OUT} = V_{SENSE} \times \text{GAIN and } V_{SENSE} = 100mV$$

Typical Performance Curves $V_{CC} = 12V, R_L = 1M\Omega$, unless otherwise specified.



FIGURE 3. HIGH-SIDE and LOW-SIDE THRESHOLD VOLTAGE
 $V_{RS+(L-H)}$ and $V_{RS+(H-L)}$, $V_{SENSE} = 10mV$

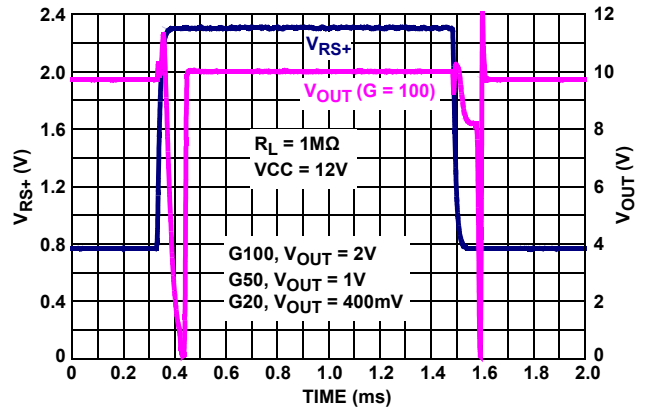

FIGURE 4. V_{OUT} vs V_{RS+} , $V_{SENSE} = 20mV$ TRANSIENT RESPONSE



FIGURE 5. LARGE SIGNAL TRANSIENT RESPONSE $V_{RS+} = 0.2V$,
 $V_{SENSE} = 100mV$

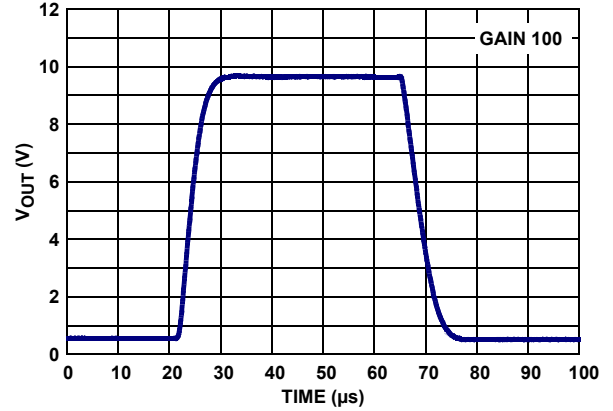

FIGURE 6. LARGE SIGNAL TRANSIENT RESPONSE $V_{RS+} = 12V$,
 $V_{SENSE} = 100mV$



FIGURE 7. V_{OS} (μV) DISTRIBUTION AT $+25^\circ C$, $V_{RS+} = 12V$,
 QUANTITY: 100

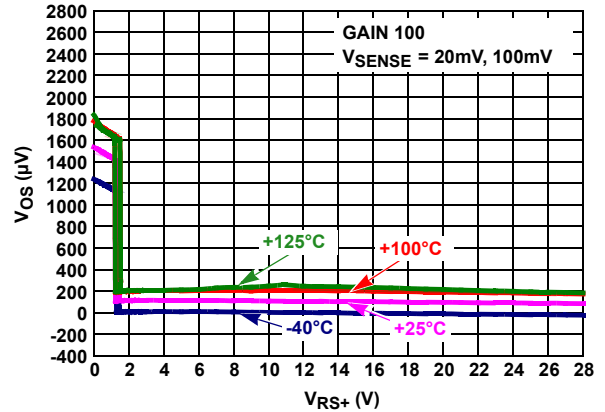

FIGURE 8. V_{OS} vs V_{RS+}

Typical Performance Curves $V_{CC} = 12V, R_L = 1M\Omega$, unless otherwise specified. (Continued)



FIGURE 9. V_{OS} vs V_{RS+}



FIGURE 10. V_{OS} vs V_{CC} , $V_{RS+} = 12V$

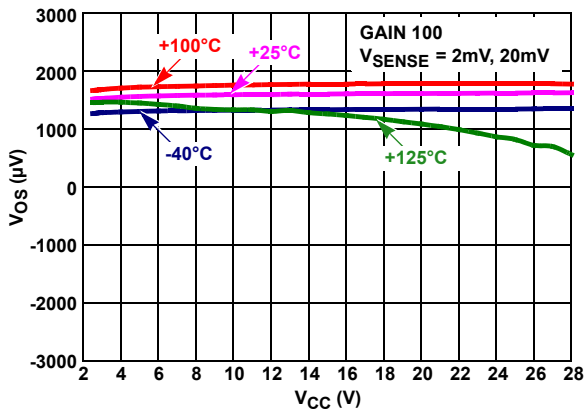

FIGURE 11. V_{OS} vs V_{CC} , $V_{RS+} = 0.1V$



FIGURE 12. GAIN ACCURACY vs $V_{RS+} = 0V$ TO $28V$

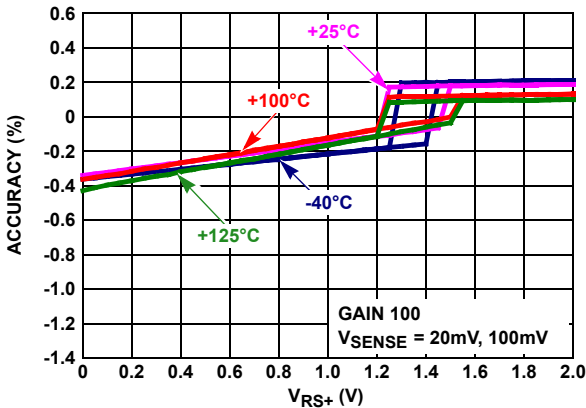

FIGURE 13. GAIN ACCURACY vs $V_{RS+} = 0V$ TO $2V$



FIGURE 14. GAIN ACCURACY vs V_{CC} , $V_{RS+} = 12V$

Typical Performance Curves $V_{CC} = 12V, R_L = 1M\Omega$, unless otherwise specified. (Continued)



FIGURE 15. GAIN ACCURACY vs V_{CC} , $V_{RS+} = 0.1V$

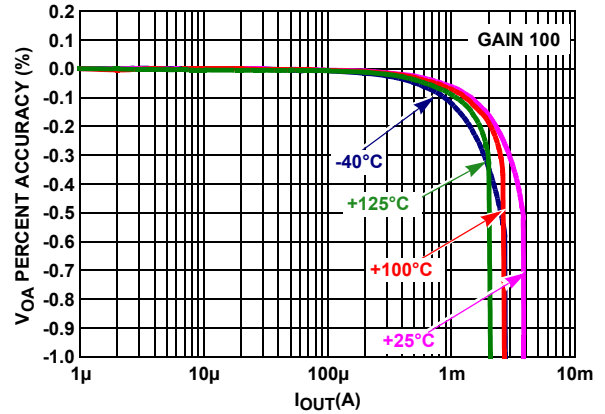

FIGURE 16. NORMALIZED V_{OA} vs I_{OUT}

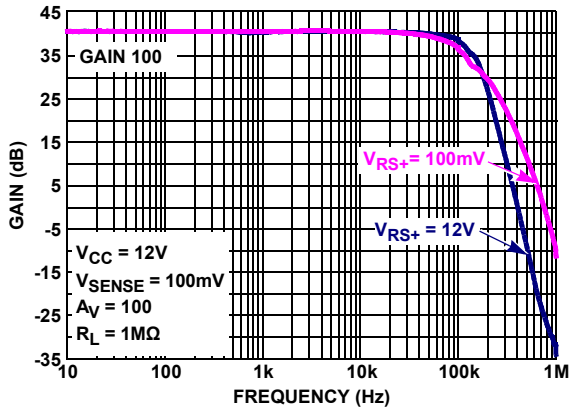

FIGURE 17. GAIN vs FREQUENCY $V_{RS+} = 100mV/12V$, $V_{SENSE} = 100mV, V_{OUT} = 50mV_{P-P}$

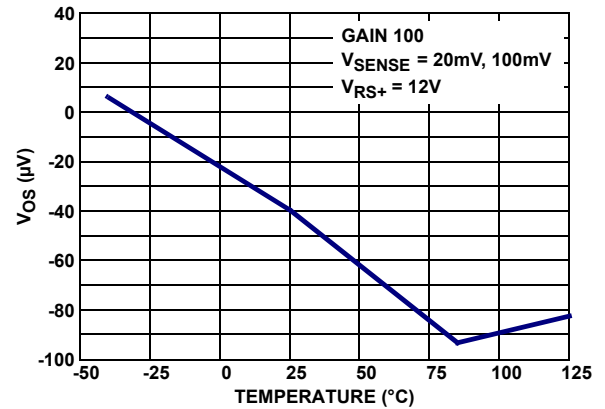

FIGURE 18. V_{OS} (μV) vs TEMPERATURE



FIGURE 19. CAPACITIVE LOAD DRIVE GAIN vs FREQUENCY



FIGURE 20. CAPACITIVE LOAD DRIVE PHASE vs FREQUENCY

Typical Performance Curves $V_{CC} = 12V$, $R_L = 1M\Omega$, unless otherwise specified. (Continued)



FIGURE 21. GAIN ACCURACY (%) vs TEMPERATURE



FIGURE 22. V_{OUT} ERROR (%) vs TEMPERATURE



FIGURE 23. V_{OS} (μV) DISTRIBUTION AT +25°C, $V_{RS+} = 12V$, QUANTITY: 100

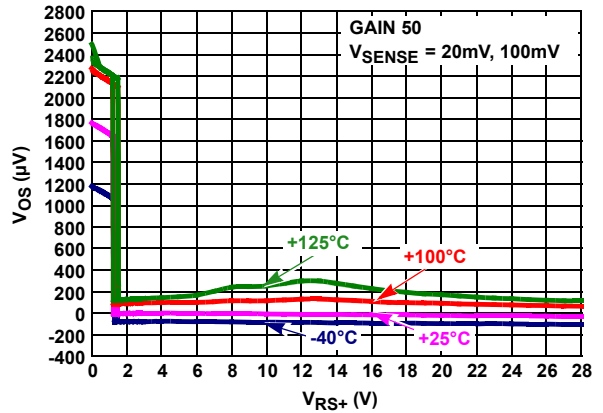

FIGURE 24. V_{OS} vs V_{RS+}

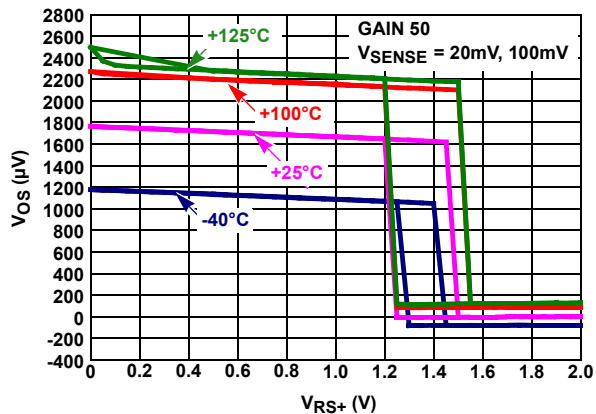

FIGURE 25. V_{OS} vs V_{RS+}

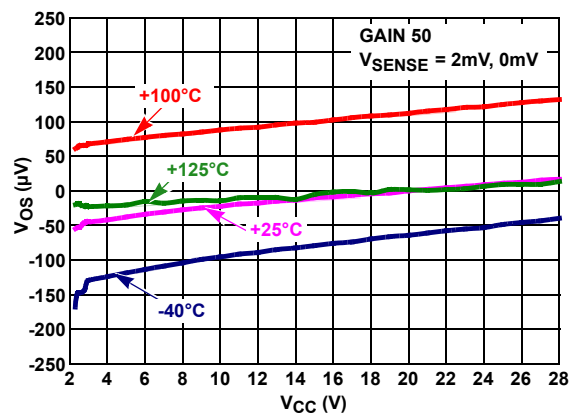

FIGURE 26. V_{OS} vs V_{CC} , $V_{RS+} = 12V$

Typical Performance Curves $V_{CC} = 12V, R_L = 1M\Omega$, unless otherwise specified. (Continued)



FIGURE 27. V_{OS} vs V_{CC} , $V_{RS+} = V_{RS+} = 0.1V$



FIGURE 28. GAIN ACCURACY vs $V_{RS+} = 0V$ TO $28V$

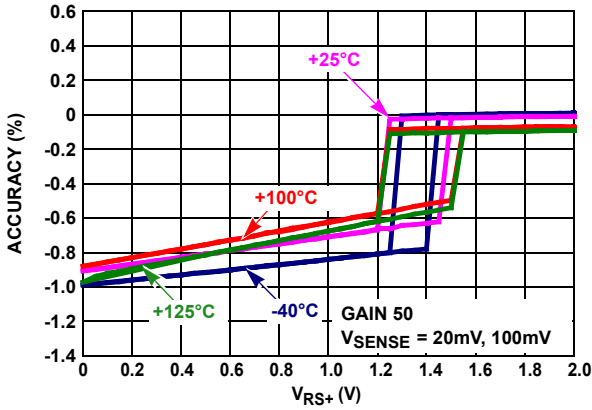

FIGURE 29. GAIN ACCURACY vs $V_{RS+} = 0V$ TO $2V$

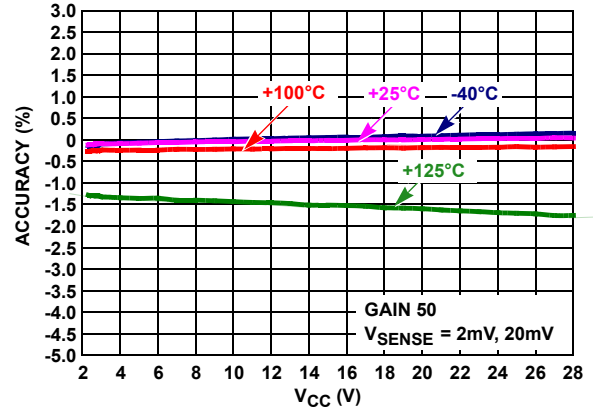

FIGURE 30. GAIN ACCURACY vs V_{CC} , HIGH-SIDE

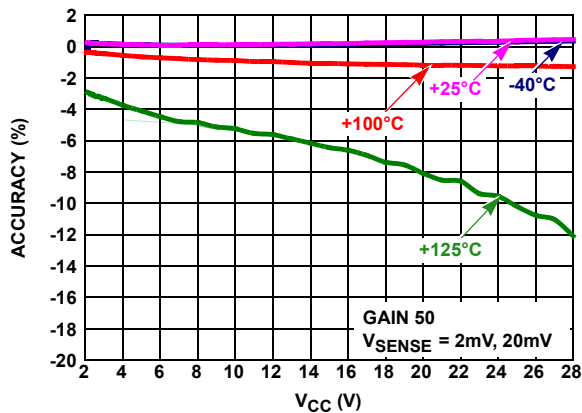

FIGURE 31. GAIN ACCURACY vs V_{CC} , LOW-SIDE



FIGURE 32. NORMALIZED V_{OA} vs I_{OUT}

Typical Performance Curves $V_{CC} = 12V, R_L = 1M\Omega$, unless otherwise specified. (Continued)



FIGURE 33. GAIN vs FREQUENCY $V_{RS+} = 100mV/12V, V_{SENSE} = 100mV, V_{OUT} = 50mV_{p-p}$

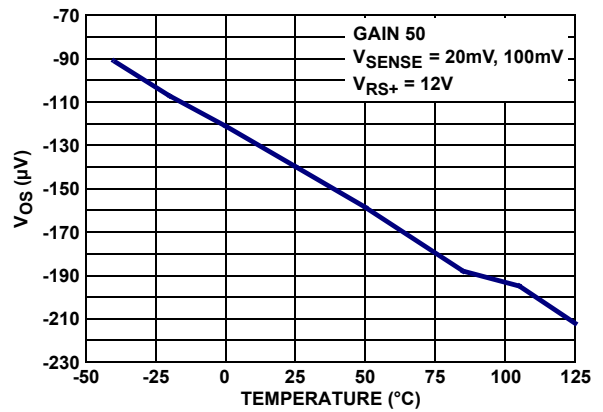

FIGURE 34. V_{OS} (μV) vs TEMPERATURE



FIGURE 35. CAPACITIVE LOAD DRIVE GAIN vs FREQUENCY

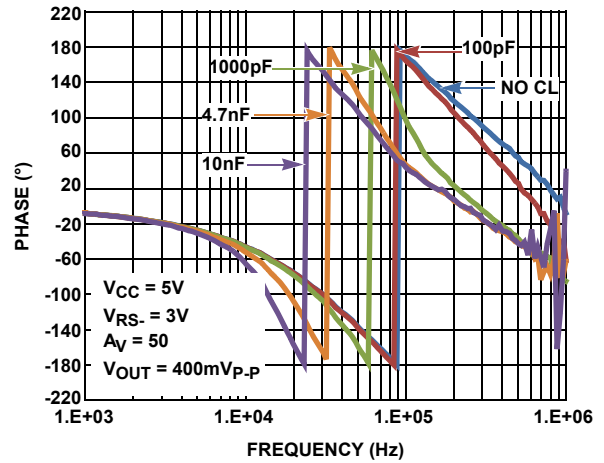

FIGURE 36. CAPACITIVE LOAD DRIVE PHASE vs FREQUENCY



FIGURE 37. GAIN ACCURACY (%) vs TEMPERATURE



FIGURE 38. V_{OUT} ERROR (%) vs TEMPERATURE

Typical Performance Curves $V_{CC} = 12V, R_L = 1M\Omega$, unless otherwise specified. (Continued)



FIGURE 39. V_{OS} (μV) DISTRIBUTION AT $+25^\circ C$, $V_{RS+} = 12V$, QUANTITY: 100



FIGURE 40. V_{OS} vs V_{RS+}



FIGURE 41. V_{OS} vs V_{RS+}

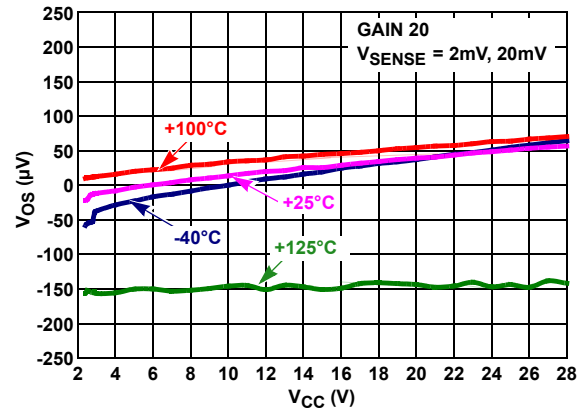

FIGURE 42. V_{OS} vs V_{CC} , $V_{RS+} = 12V$



FIGURE 43. V_{OS} vs V_{CC} , $V_{RS+} = 0.1V$

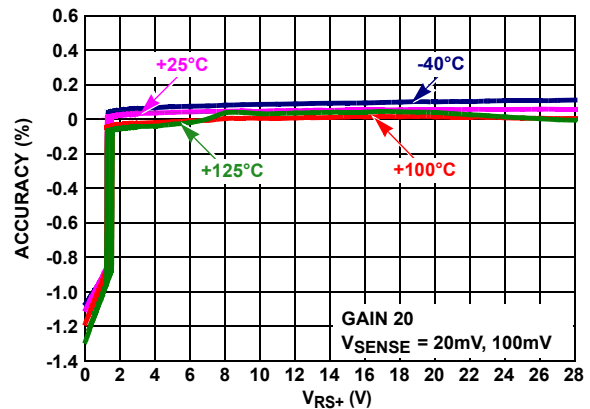

FIGURE 44. GAIN ACCURACY vs $V_{RS+} = 0V$ TO $28V$

Typical Performance Curves $V_{CC} = 12V, R_L = 1M\Omega$, unless otherwise specified. (Continued)

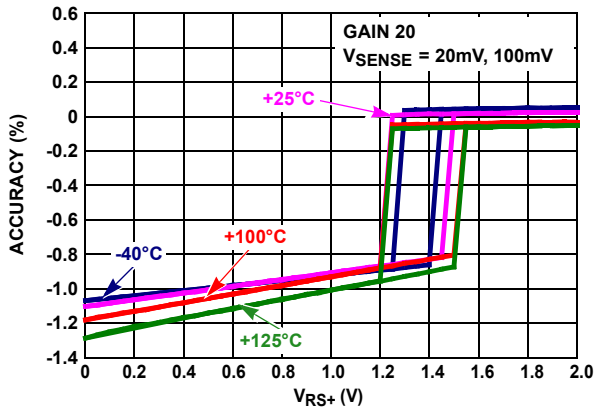

FIGURE 45. GAIN ACCURACY vs $V_{RS+} = 0V$ TO $2V$

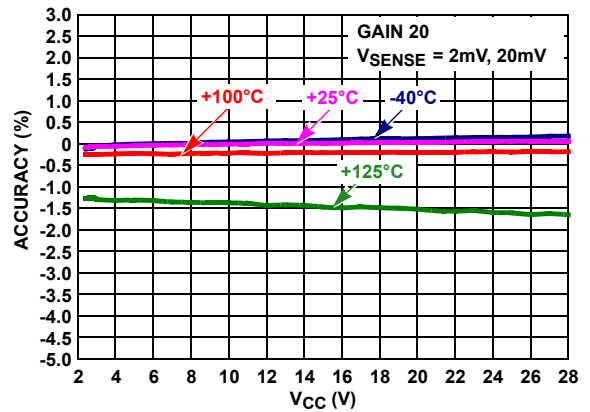

FIGURE 46. GAIN ACCURACY vs V_{CC} , HIGH-SIDE

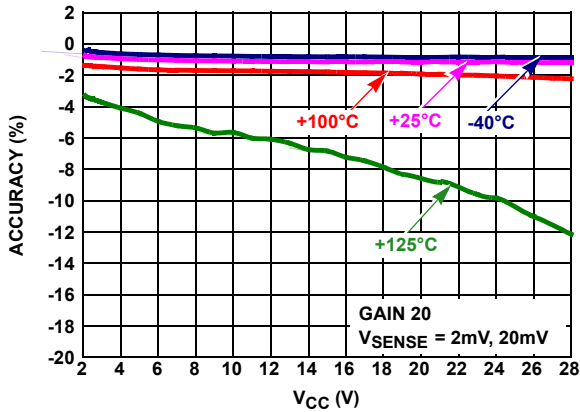

FIGURE 47. GAIN ACCURACY vs V_{CC} , LOW-SIDE



FIGURE 48. NORMALIZED V_{OA} vs I_{OUT}



FIGURE 49. GAIN vs FREQUENCY $V_{RS+} = 100mV/12V$, $V_{SENSE} = 100mV, V_{OUT} = 50mV_{p-p}$



FIGURE 50. V_{OS} (μV) vs TEMPERATURE

Typical Performance Curves $V_{CC} = 12V, R_L = 1M\Omega$, unless otherwise specified. (Continued)



FIGURE 51. CAPACITIVE LOAD DRIVE GAIN VS FREQUENCY



FIGURE 52. CAPACITIVE LOAD DRIVE PHASE VS FREQUENCY



FIGURE 53. GAIN ACCURACY (%) vs TEMPERATURE



FIGURE 54. V_{OUT} ERROR (%) vs TEMPERATURE



FIGURE 55. V_{OS} (μV) DISTRIBUTION AT $+25^\circ C, V_{RS+} = 12V$, QUANTITY: 100



FIGURE 56. V_{OS} vs V_{RS+}

Typical Performance Curves $V_{CC} = 12V, R_L = 1M\Omega$, unless otherwise specified. (Continued)



FIGURE 57. V_{OS} vs V_{RS+}



FIGURE 58. V_{OS} vs V_{CC} , HIGH-SIDE



FIGURE 59. V_{OS} vs V_{CC} , LOW-SIDE

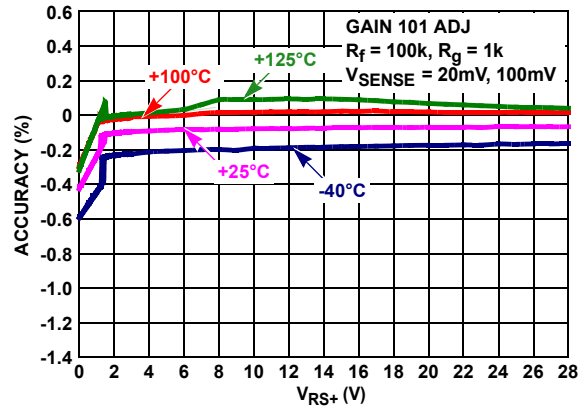

FIGURE 60. GAIN ACCURACY vs $V_{RS+} = 0V$ TO 28V

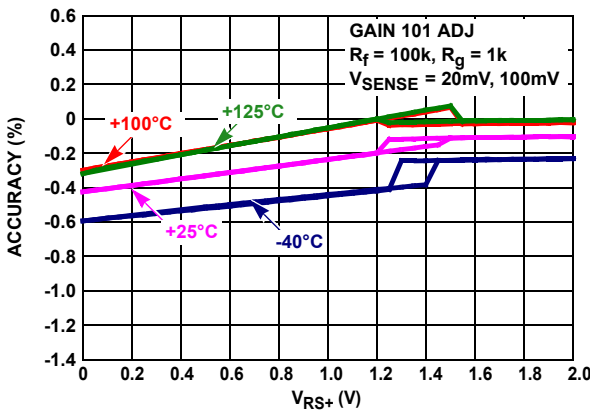

FIGURE 61. GAIN ACCURACY vs $V_{RS+} = 0V$ TO 2V

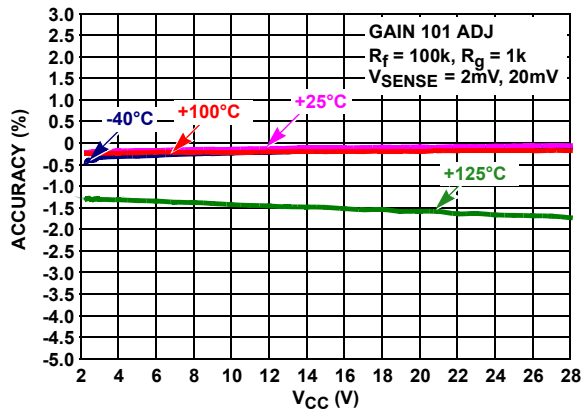

FIGURE 62. GAIN ACCURACY vs V_{CC} , $V_{RS+} = 12V$

Typical Performance Curves $V_{CC} = 12V, R_L = 1M\Omega$, unless otherwise specified. (Continued)

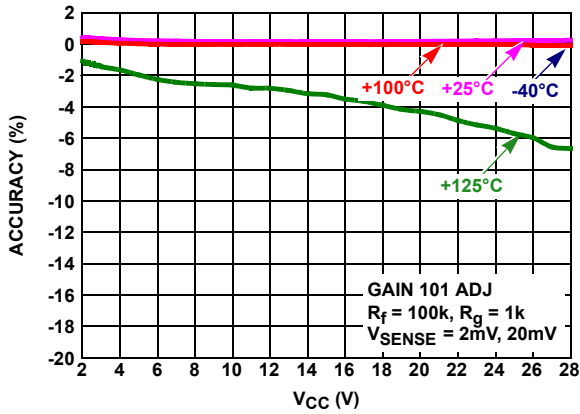

FIGURE 63. GAIN ACCURACY vs V_{CC} , $V_{RS+} = 0.1V$

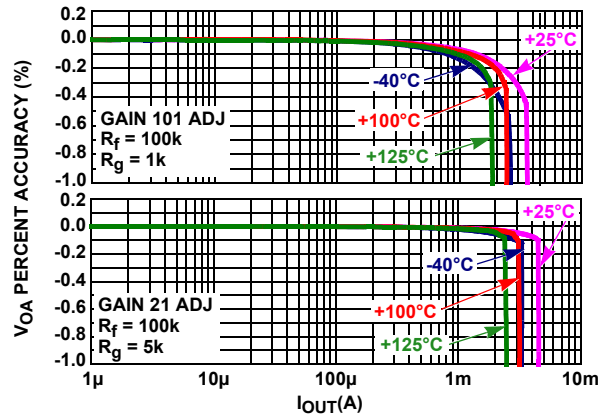

FIGURE 64. NORMALIZED V_{OA} vs I_{OUT}

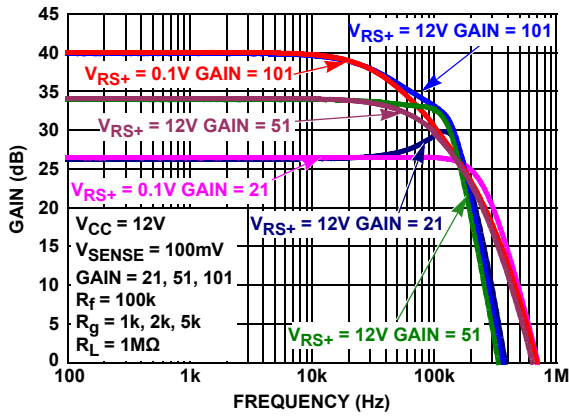

FIGURE 65. GAIN vs FREQUENCY $V_{RS+} = 100mV/12V$, $V_{SENSE} = 100mV, V_{OUT} = 50mV_{p-p}$

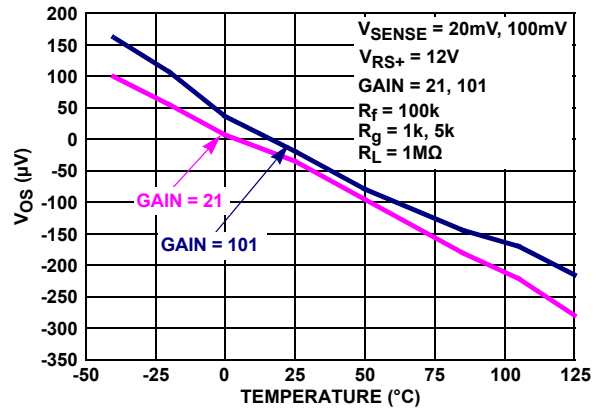

FIGURE 66. V_{OS} (μV) vs TEMPERATURE



FIGURE 67. GAIN ACCURACY (%) vs TEMPERATURE



FIGURE 68. V_{OUT} ERROR (%) vs TEMPERATURE

Typical Performance Curves $V_{CC} = 12V$, $R_L = 1M\Omega$, unless otherwise specified. (Continued)

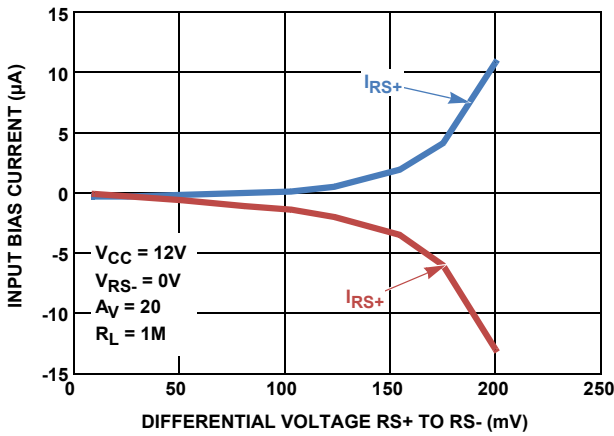

FIGURE 69. LOW SIDE CURRENT SENSING INPUT BIAS CURRENTS



FIGURE 70. HIGH SIDE CURRENT SENSING INPUT BIAS CURRENTS

Test Circuits and Waveforms



FIGURE 71. I_{CC} , V_{OS} , V_{OA} , CMRR, PSRR, GAIN ACCURACY



FIGURE 72. INPUT BIAS CURRENT, LEAKAGE CURRENT

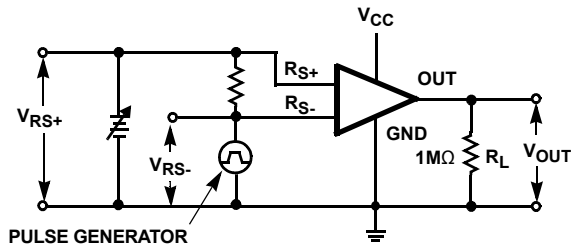

FIGURE 73. t_s , SATURATION RECOVERY TIME

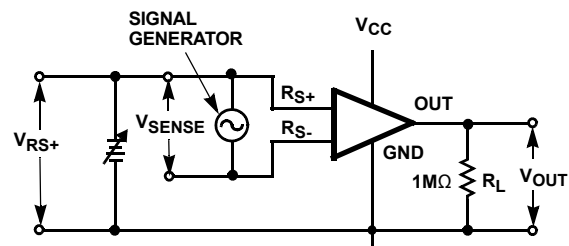

FIGURE 74. GAIN vs FREQUENCY



FIGURE 75. SLEW RATE

Applications Information

Functional Description

The ISL28006-20, ISL28006-50 and ISL28006-100 are single supply, uni-directional current sense amplifiers with fixed gains of 20V/V, 50V/V and 100V/V respectively. The ISL28006-ADJ is single supply, uni-directional current sense amplifier with an adjustable gain via external resistors (see Figure 80). The ISL28006-ADJ is stable for gains of 20 and higher.

The ISL28006 is a 2-stage amplifier. Figure 76 shows the active circuitry for high-side current sense applications where the sense voltage is between 1.35V to 28V. Figure 77 shows the active circuitry for ground sense applications where the sense voltage is between 0V to 1.35V.

The first stage is a bi-level trans-conductance amp and level translator. The gm stage converts the low voltage drop (V_{SENSE}) sensed across an external milli-ohm sense resistor, to a current (@ $g_m = 21.3\mu A/V$). The trans-conductance amplifier forces a current through R_1 resulting to a voltage drop across R_1 that is equal to the sense voltage (V_{SENSE}). The current through R_1 is mirrored across R_5 creating a ground-referenced voltage at the input of the second amplifier equal to V_{SENSE} .

The second stage is responsible for the overall gain and frequency response performance of the device. The fixed gains (20, 50, 100) are set with internal resistors R_f and R_g . The variable gain (ADJ) has an additional FB pin and uses external

gain resistors to set the gain of the output. For the fixed gain amps the only external component needed is a current sense resistor (typically 0.001Ω to 0.01Ω , 1W to 2W).

The transfer function for the fixed gain parts is given in Equation 1.

$$V_{OUT} = GAIN \times (I_S R_S + V_{OS}) \quad (EQ. 1)$$

The transfer function for the adjustable gain part is given in Equation 2.

$$V_{OUT} = \left(1 + \frac{R_F}{R_G} \right) (I_S R_S + V_{OS}) \quad (EQ. 2)$$

Where $I_S R_S$ is the product of the load current and the sense resistor and is equal to V_{SENSE} .

When the sensed input voltage is $>1.35V$, the gm_{HI} amplifier path is selected and the input gm stage derives its $\sim 2.86\mu A$ supply current from the input source through the $RS+$ terminal. When the sense voltage at $RS+$ drops below the 1.35V threshold, the gm_{LO} amplifier is enabled for Low Side current sensing. The gm_{LO} input bias current reverses, flowing out of the $RS-$ pin. Since the gm_{LO} amplifier is sensing voltage around ground, it cannot source current to $R5$. A current mirror referenced off V_{CC} supplies the current to the second stage for generating a ground referenced output voltage. See Figures 69 and 70 for typical input bias currents for High and Low side current sensing.

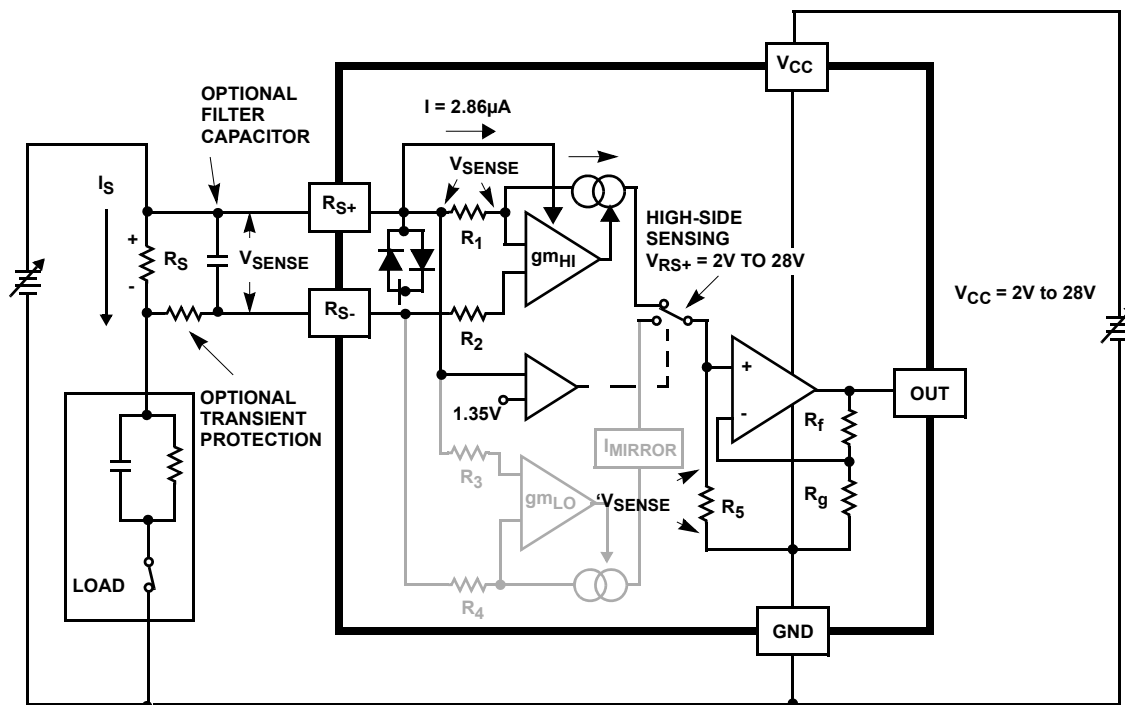

FIGURE 76. HIGH-SIDE CURRENT DETECTION

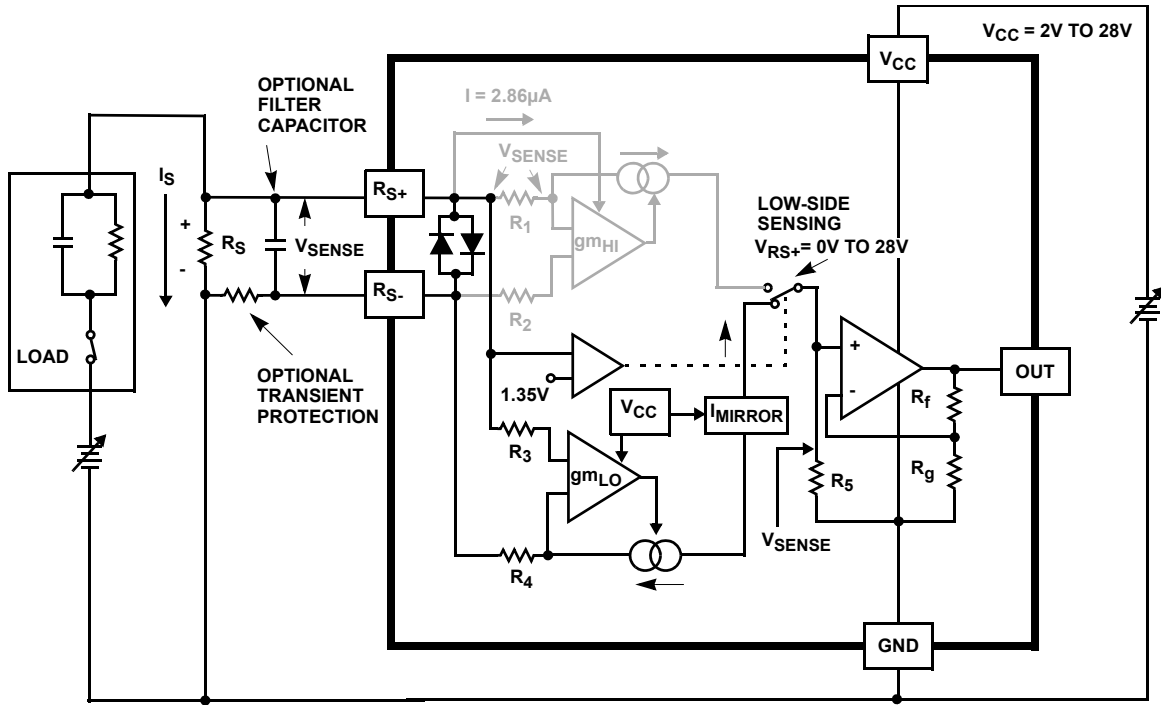

FIGURE 77. LOW-SIDE CURRENT DETECTION

Hysteretic Comparator

The input trans-conductance amps are under control of a hysteretic comparator operating from the incoming source voltage on the R_{S+} pin (Figure 78). The comparator monitors the voltage on R_{S+} and switches the sense amplifier from the low-side gm amp to the high-side gm amplifier whenever the input voltage at R_{S+} increases above the 1.35V threshold. Conversely, a decreasing voltage on the R_{S+} pin, causes the hysteric comparator to switch from the high-side gm amp to the low-side gm amp as the voltage decreases below 1.35V. It is that low-side sense gm amplifier that gives the ISL28006 the proprietary ability to sense current all the way to 0V. Negative voltages on the R_{S+} or R_{S-} are beyond the sensing voltage range of this amplifier.

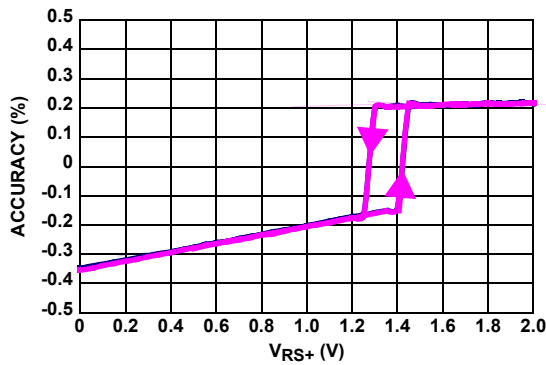

FIGURE 78. GAIN ACCURACY vs $V_{RS+} = 0V$ TO $2V$

Typical Application Circuit

Figure 80 shows the basic application circuit and optional protection components for switched-load applications. For applications where the load and the power source is permanently connected, only an external sense resistor is needed. For applications where fast transients are caused by hot plugging the source or load, external protection components may be needed. The external current limiting resistor (R_P) in Figure 80 may be required to limit the peak current through the internal ESD diodes to <20mA. This condition can occur in applications that experience high levels of in-rush current causing high peak voltages that can damage the internal ESD diodes. An R_P resistor

value of 100Ω will provide protection for a 2V transient with the maximum of 20mA flowing through the input while adding only an additional 13μV (worse case over-temperature) of V_{OS} . Refer to Equation 3:

$$((R_P \times I_{RS-}) = (100\Omega \times 130nA) = 13\mu V) \tag{EQ. 3}$$

Switching applications can generate voltage spikes that can overdrive the amplifier input and drive the output of the amplifier into the rails, resulting in a long overload recover time. Capacitors C_M and C_D filter the common mode and differential voltage spikes.

Error Sources

There are 3 dominant error sources: gain error, input offset voltage error and Kelvin voltage error (see Figure 79). The gain error is dominated by the internal resistance matching tolerances. The remaining errors appear as sense voltage errors at the input to the amplifier. They are V_{OS} of the amplifier and Kelvin voltage errors. If the transient protection resistor is added, an additional V_{OS} error can result from the $I \times R$ voltage due to input bias current. The limiting resistor should only be added to the R_{S-} input, due to the high-side gm amplifier (g_{mH1}) sinking several micro amps of current through the R_{S+} pin.

Layout Guidelines

The Kelvin Connected Sense Resistor

The source of Kelvin voltage errors is illustrated in Figure 79. The resistance of 1/2 Oz copper is ~1mΩ per square with a TC of ~3900ppm/°C (0.39%/°C). When you compare this unwanted parasitic resistance with the total 1mΩ to 10mΩ resistance of the sense resistor, it is easy to see why the sense connection must be chosen very carefully. For example, consider a maximum current of 20A through a 0.005Ω sense resistor, generating a $V_{SENSE} = 0.1$ and a full scale output voltage of 10V ($G = 100$). Two side contacts of only 0.25 square per contact puts the V_{SENSE} input about 0.5 x 1mΩ away from the resistor end capacitor. If only 10A the 20A total current flows through the kelvin path to the resistor, you get an error voltage of 10mV ($10A \times 0.5sq \times 0.001\Omega/sq. = 10mV$) added to the 100mV sense voltage for a sense voltage error of 10% $((0.110V-0.1)/0.1V) \times 100$.

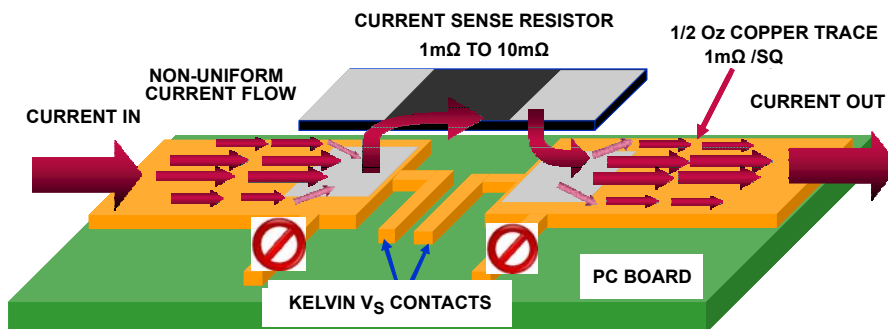

FIGURE 79. PC BOARD CURRENT SENSE KELVIN CONNECTION



FIGURE 80. TYPICAL APPLICATION CIRCUIT

Overall Accuracy (V_{OA} %)

V_{OA} is defined as the total output accuracy Referred-to-Output (RTO). The output accuracy contains all offset and gain errors, at a single output voltage. Equation 4 is used to calculate the % total output accuracy.

$$V_{OA} = 100 \times \left(\frac{V_{OUT\text{actual}} - V_{OUT\text{expected}}}{V_{OUT\text{expected}}} \right) \quad \text{(EQ. 4)}$$

where

$$V_{OUT\text{Actual}} = V_{SENSE} \times \text{GAIN}$$

Example: Gain = 100, For 100mV V_{SENSE} input we measure 10.1V. The overall accuracy (V_{OA}) is 1% as shown in Equation 5.

$$V_{OA} = 100 \times \left(\frac{10.1 - 10}{10} \right) = 1\% \quad \text{(EQ. 5)}$$

Power Dissipation

It is possible to exceed the +150°C maximum junction temperatures under certain load and power supply conditions. It is therefore important to calculate the maximum junction temperature (T_{JMAX}) for all applications to determine if power supply voltages, load conditions, or package type need to be modified to remain in the safe operating area. These parameters are related using Equation 6:

$$T_{JMAX} = T_{MAX} + \theta_{JA} \times PD_{MAXTOTAL} \quad \text{(EQ. 6)}$$

where:

- PD_{MAXTOTAL} is the sum of the maximum power dissipation of each amplifier in the package (PD_{MAX})
- PD_{MAX} for each amplifier can be calculated using Equation 7:

$$PD_{MAX} = V_S \times I_{qMAX} + (V_S - V_{OUTMAX}) \times \frac{V_{OUTMAX}}{R_L} \quad \text{(EQ. 7)}$$

where:

- T_{MAX} = Maximum ambient temperature
- θ_{JA} = Thermal resistance of the package
- PD_{MAX} = Maximum power dissipation of 1 amplifier
- V_{CC} = Total supply voltage
- I_{qMAX} = Maximum quiescent supply current of 1 amplifier
- V_{OUTMAX} = Maximum output voltage swing of the application
- R_L = Load resistance

Revision History

The revision history provided is for informational purposes only and is believed to be accurate, but not warranted. Please go to web to make sure you have the latest Rev.

DATE	REVISION	CHANGE
November 22, 2013	FN6548.6	<p>Added eight new Typical Performance Curves</p> <ol style="list-style-type: none"> 1. Av=100 Capacitive Load Drive Gain vs Freq 2. Av=100 Capacitive Load Drive Phase vs Freq 3. Av=50 Capacitive Load Drive Gain vs Freq 4. Av=50 Capacitive Load Drive Phase vs Freq 5. Av=20 Capacitive Load Drive Gain vs Freq 6. Av=20 Capacitive Load Drive Phase vs Freq 7. High Side Operation Input Bias Currents 8. Low Side Operation Input Bias Currents <p>Under Electrical Specifications Table: Changed parameter from Is to Icc to clarify supply current Ordering information table on page 3: Changed Note 4 location in the table.</p>
April 12, 2011	FN6548.5	<p>Converted to new template</p> <p>Page 1 - Changed headings for "Typical Application" and "Gain Accuracy vs VRS+ = 0V to 28V" to Figure titles (Figures 1 and 2).</p> <p>Page 1 - Updated Intersil Trademark statement at bottom of page 1 per directive from Legal.</p> <p>Page 7 - Updated over temp note in Min Max column of spec tables from "Parameters with MIN and/or MAX limits are 100% tested at +25 °C, unless otherwise specified. Temperature limits established by characterization and are not production tested." to new standard "Compliance to datasheet limits is assured by one or more methods: production test, characterization and/or design."</p> <p>Page 19 - Figure 69, Low side current detection schematic: Moved the LOAD from the ground side of the power side circuit to the high side.</p>
September 2, 2010	FN6548.4	Added -T7A tape and reel options to Ordering Information Table for all packages.
May 12, 2010	FN6548.3	<p>Added Note 4 to Part Marking Column in "Ordering Information" on page 3.</p> <p>Corrected hyperlinks in Notes 1 and 3 in "Ordering Information" on page 3.</p>
April 8, 2010		Removed "Coming Soon" from evaluation boards in "Ordering Information" on page 3.
April 7, 2010		<p>Added "Related Literature" on page 1</p> <p>Updated Package Drawing Number in the "Ordering Information" on page 3 for the 20V, 50V and 100V options from MDP0038 to P50.64A.</p> <p>Revised package outline drawing from MDP0038 to P5.064A on page 24. MDP0038 package contained 2 packages for both the 5 and 6 Ld SOT-23. MDP0038 was obsoleted and the packages were separated and made into 2 separate package outline drawings; P5.064A and P6.064A. Changes to the 5 Ld SOT-23 were to move dimensions from table onto drawing, add land pattern and add JEDEC reference number.</p>
March 10, 2010	FN6548.2	<p>Releasing adjustable gain option.</p> <p>Added adjustable block diagram (Page 2), Added adjustable gain limits to electrical spec table, added Figures 47 through 60, Added +85 °C curves to Figures 6 thru 14, 20 thru 28, 34 thru 42, and Figures 48 thru 56. Modified Figure 70.</p>
February 4, 2010	FN6548.1	<p>-Page 1: Edited last sentence of paragraph 2. Moved order of GAIN listings from 20, 50, 100 to 100, 50, 20 in the 3rd paragraph. Under Featuresremoved "Low Input Offset Voltage 250µV, max" Under Features moved order of parts listing from 20, 50, 100 (from top to bottom) to 100, 50, 20.</p> <p>-Page 3: Removed coming soon on ISL28006FH50Z and ISL28006FH20Z and changes the order or listing them to 100, 50, 20.</p> <p>-Page 5: VOA test. Under conditions column ...deleted 20mV to. It now reads ... Vsense = 100mV SR test. Under conditions column ..deleted what was there. It now reads ... Pulse on RS+pin, See Figure 51</p> <p>-Page 6: ts test. Removed Gain = 100 and Gain = 100V/V in both description and conditions columns respectively.</p> <p>-Page 9: Added VRS+= 12V to Figures 16, 17, 18.</p> <p>-Page 11: Added VRS+= 12V to Figures 30, 31, 32.</p> <p>-Page 13 & 14: Added VRS+= 12V to Figures 44, 45, 46.</p> <p>-Page 14 Added Figure 51 and adjusted figure numbers to account for the added figure.</p> <p>-Figs 8, 26, and 40 change "HIGH SIDE" to "VRS = 12V", where RS is subscript.</p> <p>-Figs 9, 27, and 41 change "LOW SIDE" to "VRS = 0.1V", where RS is subscript.</p>
December 14, 2009	FN6548.0	Initial Release

About Intersil

Intersil Corporation is a leader in the design and manufacture of high-performance analog, mixed-signal and power management semiconductors. The company's products address some of the largest markets within the industrial and infrastructure, personal computing and high-end consumer markets. For more information about Intersil, visit our website at www.intersil.com.

For the most updated datasheet, application notes, related documentation and related parts, please see the respective product information page found at www.intersil.com. You may report errors or suggestions for improving this datasheet by visiting www.intersil.com/en/support/ask-an-expert.html. Reliability reports are also available from our website at <http://www.intersil.com/en/support/qualandreliability.html#reliability>

© Copyright Intersil Americas LLC 2009-2013. All Rights Reserved.
All trademarks and registered trademarks are the property of their respective owners.

For additional products, see www.intersil.com/en/products.html

Intersil products are manufactured, assembled and tested utilizing ISO9001 quality systems as noted in the quality certifications found at www.intersil.com/en/support/qualandreliability.html

Intersil products are sold by description only. Intersil may modify the circuit design and/or specifications of products at any time without notice, provided that such modification does not, in Intersil's sole judgment, affect the form, fit or function of the product. Accordingly, the reader is cautioned to verify that datasheets are current before placing orders. Information furnished by Intersil is believed to be accurate and reliable. However, no responsibility is assumed by Intersil or its subsidiaries for its use; nor for any infringements of patents or other rights of third parties which may result from its use. No license is granted by implication or otherwise under any patent or patent rights of Intersil or its subsidiaries.

For information regarding Intersil Corporation and its products, see www.intersil.com

Package Outline Drawing

P5.064A

5 LEAD SMALL OUTLINE TRANSISTOR PLASTIC PACKAGE

Rev 0, 2/10

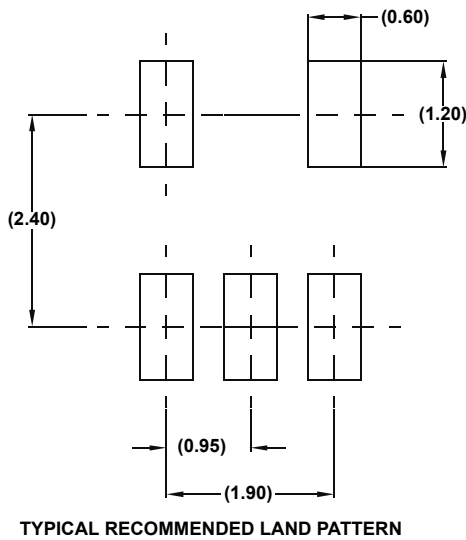

NOTES:

1. Dimensions are in millimeters.
Dimensions in () for Reference Only.
2. Dimensioning and tolerancing conform to ASME Y14.5M-1994.
3. Dimension is exclusive of mold flash, protrusions or gate burrs.
4. Foot length is measured at reference to gauge plane.
5. This dimension is measured at Datum "H".
6. Package conforms to JEDEC MO-178AA.

Package Outline Drawing

P6.064

6 LEAD SMALL OUTLINE TRANSISTOR PLASTIC PACKAGE

Rev 4, 2/10



NOTES:

1. Dimensions are in millimeters.
Dimensions in () for Reference Only.
2. Dimensioning and tolerancing conform to ASME Y14.5M-1994.
3. Dimension is exclusive of mold flash, protrusions or gate burrs.
4. Foot length is measured at reference to gauge plane.
5. Package conforms to JEDEC MO-178AB.



Компания «ЭлектроПласт» предлагает заключение долгосрочных отношений при поставках импортных электронных компонентов на взаимовыгодных условиях!

Наши преимущества:

- Оперативные поставки широкого спектра электронных компонентов отечественного и импортного производства напрямую от производителей и с крупнейших мировых складов;
- Поставка более 17-ти миллионов наименований электронных компонентов;
- Поставка сложных, дефицитных, либо снятых с производства позиций;
- Оперативные сроки поставки под заказ (от 5 рабочих дней);
- Экспресс доставка в любую точку России;
- Техническая поддержка проекта, помощь в подборе аналогов, поставка прототипов;
- Система менеджмента качества сертифицирована по Международному стандарту ISO 9001;
- Лицензия ФСБ на осуществление работ с использованием сведений, составляющих государственную тайну;
- Поставка специализированных компонентов (Xilinx, Altera, Analog Devices, Intersil, Interpoint, Microsemi, Aeroflex, Peregrine, Syfer, Eurofarad, Texas Instrument, Miteq, Cobham, E2V, MA-COM, Hittite, Mini-Circuits, General Dynamics и др.);

Помимо этого, одним из направлений компании «ЭлектроПласт» является направление «Источники питания». Мы предлагаем Вам помощь Конструкторского отдела:

- Подбор оптимального решения, техническое обоснование при выборе компонента;
- Подбор аналогов;
- Консультации по применению компонента;
- Поставка образцов и прототипов;
- Техническая поддержка проекта;
- Защита от снятия компонента с производства.



Как с нами связаться

Телефон: 8 (812) 309 58 32 (многоканальный)

Факс: 8 (812) 320-02-42

Электронная почта: org@eplast1.ru

Адрес: 198099, г. Санкт-Петербург, ул. Калинина, дом 2, корпус 4, литера А.