

B-Series Circuit Breaker

The B-Series hydraulic/magnetic circuit breakers are compact and temperature stable designed for precision operation in OEM markets requiring general purpose as well as full load amp applications. These circuit breakers are designed specifically for world market applications requiring extra insulation and tongue & groove half-shell constructions. Actuators available include handle for 1- 6 poles, rocker for 1-3 poles, and Visi-Rocker for 1-3 poles construction. They are also offered with ratings from 0.02 to 50 amps and up to 277VAC or 80VDC, with choices of time delays, terminals, wide range of standard colors, imprinting.

Additional Features:

- ♦ Meet CSA Standard 22.2 No. 100 for the Generator & Welder markets
- ♦ Extra insulation and tongue & groove half-shell constructions

Applications:

- ♦ Power Supplies
- ♦ Medical Equipment
- ♦ Generator & Welder Markets
- ♦ Office Equipment
- ♦ Control Panels
- ♦ Marine
- ♦ Military



1 POLE



2 POLE

Agency Certifications:

- ♦ UL Recognized – *UL Standard 508, 1077, 1500*
- ♦ UL Listed – *UL Standard 489, 489A*
- ♦ CSA Accepted
- ♦ TUV Certified
- ♦ VDE Certified



Carling Technologies®

Innovative Designs. Powerful Solutions.

Innovative Designs. Powerful Solutions.

Carling Technologies, Inc.
60 Johnson Avenue • Plainville, CT 06062-1177
Phone: (860) 793-9281 • Fax: (860) 793-9231
Email: sales@carlingtech.com • www.carlingtech.com

Electrical

Maximum Voltage 277VAC 50/60 Hz, 80VDC
 Current Ratings Standard current coils: 0.100, 0.250, 0.500, 0.750, 1.00, 2.50, 5.00, 7.50, 10.0, 15.0, 20.0, 25.0, 30.0, 35.0, 40.0 and 50.0 amps. Other ratings available, see ordering scheme.
 Standard Voltage Coils DC - 6V, 12V; AC - 120V, other ratings available, see ordering scheme.
 Auxiliary Switch Rating SPDT; 10.1 AMPS - 250VAC, 1.0A 65 VDC or 0.5A 80 VDC, 0.1 Amps - 125VAC (with gold contacts). VDE-1.0 Amp - 125VAC.
 Insulation Resistance Minimum of 100 Megohms at 500 VDC.
 Dielectric Strength UL, CSA - 1500 V 50/60 Hz for one minute between all electrically isolated terminals. B-Series circuit breakers comply with the 8mm spacing and 3750V 50/60 Hz dielectric requirements from hazardous voltage to operator accessible surfaces, between adjacent poles and from main circuits to auxiliary circuits per Publications EN 60950 and VDE 0805.
 Resistance, Impedance Values from Line to Load Terminal - based on Series Trip Circuit Breaker.



| CURRENT (AMPS) | TOLERANCE (%) |
|----------------|---------------|
| 0.10 - 5.0 | 15% |
| 5.1 - 20.0 | 25% |
| 20.1 - 50.0 | 35% |

Pulse Tolerance Curves



*Manufacturer reserves the right to change product specification without prior notice.

Mechanical

Endurance 6,000 ON-OFF operations @ 6 per minute; with rated Current and Voltage. Additional 4,000 ON-OFF mechanical
 Trip Free All B-Series Circuit Breakers will trip on overload, even when Handle is forcibly held in the ON position.
 Trip Indication The operating Handle moves positively to the OFF position when an overload causes the breaker to trip.

Physical

Number of Poles 1 - 6 poles at 30 Amps or less. 1 and 2 poles at 31 Amps thru 50 Amps.
 Internal Circuit Config. Series, (with or without auxiliary switch), Shunt and Relay with current or voltage trip coils, Dual Coil, Switch Only (with or without auxiliary switch).
 Weight Approximately 65 grams/pole. (Approximately 2.32 ounces/pole)
 Standard Colors Housing - Black; Actuator- See Ordering Scheme.

Environmental

Designed and tested in accordance with requirements of specification MIL-PRF-55629 & MIL-STD-202 as follows:
 Shock Withstands 100 Gs, 6ms, sawtooth while carrying rated current per Method 213, Test Condition "I". Instantaneous and ultra-short curves tested @ 90% of rated current.
 Vibration Withstands 0.060" excursion from 10-55 Hz, and 10 Gs 55-500 Hz, at rated current per Method 204C, Test Condition A. Instantaneous and ultrashort curves tested at 90% of rated current.
 Moisture Resistance Method 106D; ten 24-hour cycles @ +25°C to +65°C, 80-98% RH.56 days @ +85°C, 85% RH.
 Salt Spray Method 101, Condition A (90-95% RH @ 5% NaCl Solution, 96 hrs).
 Thermal Shock Method 107D, Condition A (Five cycles @ -55°C to +25°C to +85°C to +25°C).
 Operating Temperature -40°C to +85°C.

Electrical Tables

Table A: Lists UL Recognized & CSA Certified configurations and performance capabilities as a Component Supplementary Protector.

| B -SERIES TABLE A: COMPONENT SUPPLEMENTARY PROTECTORS | | | | | | | | | | |
|---|-------------|-----------|----------------|----------------|----------------------|-------------------------------|---------------------|-------------------|---------------|--------------------|
| CIRCUIT CONFIGURATION | VOLTAGE | | | CURRENT RATING | | SHORT CIRCUIT CAPACITY (AMPS) | | APPLICATION CODES | | CONSTRUCTION NOTES |
| | MAX. RATING | FREQUENCY | PHASE | FULL LOAD AMPS | GENERAL PURPOSE AMPS | UL/CSA | | UL | CSA | |
| | | | | | | WITH BACKUP FUSE | WITHOUT BACKUP FUSE | | | |
| SERIES | 65 | DC | -- | 31 - 50 | -- | -- | 7500 | TC1,2, OL1,U1 | TC1,2, OL1,U1 | |
| | 80 | DC | -- | 0.02 - 30 | -- | -- | 7500 | TC1,2, OL1,U1 | TC1,2, OL1,U1 | |
| | | | | -- | 31 - 50 | -- | 7500 | TC1,2, OL0,U1 | TC1,2, OL0,U1 | |
| | 125 | 50 / 60 | 1 | 1 - 50 | -- | -- | 2000 | TC1, OL1,U2 | TC1, OL1,U2 | |
| | 125 | 50 / 60 | 1 ⁴ | 1 - 50 | -- | -- | 1000 | TC1, OL1,U2 | TC3, OL1,U3 | |
| | 125 / 250 | 50 / 60 | 1 ³ | 0.02 - 30 | -- | -- | 3000 | TC1,2, OL1,U1 | TC1,2, OL1,U1 | |
| | 250 | 50 / 60 | 1 | 0.02 - 30 | -- | -- | 1500 | TC1, OL0,U2 | TC1, OL0,U2 | Single Pole Break |
| | | | | 0.02 - 30 | -- | -- | 3000 | TC1, OL1,U2 | TC1, OL1,U2 | Two Pole Break |
| | | | | -- | 31 - 50 | -- | 3000 | TC1,2, OL0,U1 | TC1,2, OL0,U1 | |
| | | | 1 ⁴ | 1 - 50 | -- | 1000 | TC1, OL1,U2 | TC3, OL1,U3 | | |
| | | | 3 | 0.02 - 30 | -- | 5000 ² | -- | TC1,2, OL1,C1 | TC1,2, OL1,C1 | |
| | | | | 31 - 50 | -- | 2000 ¹ | -- | TC1,2, OL1,C1 | TC1,2, OL1,C1 | |
| 277 | 50 / 60 | 1 | 0.02 - 30 | -- | 5000 ¹ | -- | TC1,2, OL1,C1 | TC1,2, OL1,C1 | | |
| DUAL COIL | 65 | DC | -- | 0.02 - 50 | -- | -- | 7500 | TC1,2, OL1,U1 | TC1,2, OL1,U1 | |
| | 80 | DC | -- | 0.02 - 30 | -- | -- | 7500 | TC1,2, OL1,U1 | TC1,2, OL1,U1 | |
| | | | | -- | 31 - 50 | -- | 7500 | TC1,2, OL0,U1 | TC1,2, OL0,U1 | |
| | 125 | 50 / 60 | 1 | 1 - 50 | -- | -- | 2000 | TC1, OL1,U2 | TC1, OL1,U2 | |
| | 125 / 250 | 50 / 60 | 1 ³ | 0.02 - 30 | -- | -- | 3000 | TC1,2, OL1,U1 | TC1,2, OL1,U1 | |
| | 250 | 50 / 60 | 1 | 0.02 - 30 | -- | -- | 1500 | TC1, OL0,U2 | TC1, OL0,U2 | Single Pole Break |
| | | | | 0.02 - 30 | -- | -- | 3000 | TC1, OL1,U2 | TC1, OL1,U2 | Two Pole Break |
| | | | | -- | 31 - 50 | -- | 3000 | TC1,2, OL0,U1 | TC1,2, OL0,U1 | |
| | | | 1 ⁴ | 1 - 50 | -- | 1000 | TC1, OL1,U2 | TC3, OL1,U3 | | |
| | | | 3 | 0.02 - 30 | -- | 5000 ² | -- | TC1,2, OL1,C1 | TC1,2, OL1,C1 | |
| | | | | 31 - 50 | -- | 2000 ¹ | -- | TC1,2, OL1,C1 | TC1,2, OL1,C1 | |
| | 277 | 50 / 60 | 1 | 0.02 - 30 | -- | 5000 ¹ | -- | TC1,2, OL1,U1 | TC1,2, OL1,U1 | |
| SHUNT | 80 | DC | -- | 0.02 - 30 | -- | -- | 7500 | TC1,2, OL1,U1 | TC1,2, OL1,U1 | |
| | 125 / 250 | 50 / 60 | 1 ³ | 0.02 - 30 | -- | -- | 3000 | TC1,2, OL1,U1 | TC1,2, OL1,U1 | |
| | 250 | 50 / 60 | 1 | 0.02 - 30 | -- | -- | 3000 | TC1,2, OL1,U1 | TC1,2, OL1,U1 | |
| | | | 3 | 0.02 - 30 | -- | 5000 ² | -- | TC1,2, OL1,C1 | TC1,2, OL1,C1 | |
| | 277 | 50 / 60 | 1 | 0.02 - 30 | -- | 5000 ¹ | -- | TC1,2, OL1,C1 | TC1,2, OL1,C1 | |
| | RELAY | 80 | DC | -- | 0.02 - 30 | -- | -- | 7500 | TC1,2, OL1,U1 | TC1,2, OL1,U1 |
| 125 / 250 | | 50 / 60 | 1 ³ | 0.02 - 30 | -- | -- | 3000 | TC1,2, OL1,U1 | TC1,2, OL1,U1 | |
| 250 | | 50 / 60 | 1 | 0.02 - 30 | -- | -- | 3000 | TC1,2, OL1,U1 | TC1,2, OL1,U1 | |
| | | | 3 | 0.02 - 30 | -- | 5000 ² | -- | TC1,2, OL1,C1 | TC1,2, OL1,C1 | |
| 277 | | 50 / 60 | 1 | 0.02 - 30 | -- | 5000 ¹ | -- | TC1,2, OL1,C1 | TC1,2, OL1,C1 | |
| SWITCH ONLY | 65 | DC | -- | 0.02 - 50 | -- | -- | -- | -- | -- | |
| | 80 | DC | -- | 0.02 - 30 | -- | -- | -- | -- | -- | |
| | 250 | 50 / 60 | 1 | -- | 31 - 50 | -- | -- | -- | -- | |
| | | | 3 | 0.02 - 50 | -- | -- | -- | -- | -- | |
| 277 | 50 / 60 | 1 | 0.02 - 30 | 31 - 50 | -- | -- | -- | -- | | |

Notes:

- 1 Requires branch circuit backup with a UL LISTED Type K5 or RK5 fuse (15A minimum) at no more than 4 times the rating of the protector.
- 2 Same as note 1, except that backup fuse is limited to 80A maximum.
- 3 2 pole protector required (with one pole per power line) for: 250/125 VAC, 125/250 VAC and 208Y/120 VAC Power Systems. 1 pole protector required for : 125 VAC, 1Ø Power System.

Electrical Tables

Table B: Lists UL Recognized, CSA, VDE & TUV Certified configurations & performance capabilities as a Component Supplementary Protector.

| B-SERIES TABLE B: COMPONENT SUPPLEMENTARY PROTECTORS | | | | | | | | | | | | | | | | | |
|--|-------------|-----------|-----------|----------------|-----------------------------------|-------------------------------|---------------------|------------------------|----------------------|------------------------|----------------------|-------------------|---------------|--------------------|---------------|---------------|---------------|
| CIRCUIT CONFIGURATION | VOLTAGE | | | CURRENT RATING | | SHORT CIRCUIT CAPACITY (AMPS) | | | | | | APPLICATION CODES | | CONSTRUCTION NOTES | | | |
| | MAX. RATING | FREQUENCY | PHASE | FULL LOAD AMPS | GENERAL PURPOSE AMPS ¹ | UL/CSA | | VDE | | TUV | | UL | CSA | | | | |
| | | | | | | WITH BACKUP FUSE | WITHOUT BACKUP FUSE | (Inc) WITH BACKUP FUSE | (Inc) WITHOUT BACKUP | (Inc) WITH BACKUP FUSE | (Inc) WITHOUT BACKUP | | | | | | |
| SERIES | 80 | DC | --- | 0.10 - 30 | --- | --- | 7500 | 3000 | 1500 | 3000 | 1500 | TC1,2, OL1,U1 | TC1,2, OL1,U1 | | | | |
| | | | | 31 - 50 | 31 - 50 | --- | 7500 | 3000 | 1500 | 3000 | 1500 | TC1,2, OL0,U1 | TC1,2, OL0,U1 | | | | |
| | | | | 0.10 - 30 | --- | --- | 7500 | 3000 | 1500 | 3000 | 1500 | TC1,2, OL1,U1 | TC1,2, OL1,U1 | | | | |
| | | | | 31 - 32 | --- | --- | 7500 | 3000 | 1500 | 3000 | 1500 | TC1,2, OL1,U1 | TC1,2, OL1,U1 | | | | |
| | 250 | 50 / 60 | 1 | 0.10 - 30 | --- | --- | 3000 | 3000 | 1500 | 5000 | 1500 | TC1,2, OL1,U1 | TC1,2, OL1,U1 | | | | |
| | | | | 31 - 50 | 31 - 50 | --- | 3000 | --- | --- | 5000 | 1500 | TC1,2, OL0,U1 | TC1,2, OL0,U1 | | | | |
| | | | | 31 - 32 | --- | --- | 3000 | 6000 | 1500 | 5000 | 1500 | TC1,2, OL1,U1 | TC1,2, OL1,U1 | | | | |
| | | | | 0.10 - 30 | --- | --- | 1500 | 3000 | 1500 | 5000 | 1500 | TC1, OL0,U2 | TC1, OL0,U2 | Single Pole Break | | | |
| | | | | 0.10 - 30 | --- | --- | 3000 | 3000 | 1500 | 5000 | 1500 | TC1, OL1,U2 | TC1, OL1,U2 | Two Pole Break | | | |
| | | | | 3 | 0.10 - 30 | --- | 5000 ³ | --- | 3000 | 1500 | 3000 | 1500 | TC1,2, OL1,C1 | TC1,2, OL1,C1 | | | |
| | | | | 415 | 50 / 60 | 3 | 0.10 - 30 | --- | --- | 1000 | 3000 | 1500 | 3000 | 1500 | TC1,2, OL1,C1 | TC1,2, OL1,C1 | |
| | | | | DUAL COIL | 80 | DC | --- | 0.10 - 30 | --- | --- | 7500 | 3000 | 1500 | 3000 | 1500 | TC1,2, OL1,U1 | TC1,2, OL1,U1 |
| 0.10 - 30 | --- | --- | 3000 | | | | | 3000 | 1500 | 5000 | 1500 | TC1,2, OL1,U1 | TC1,2, OL1,U1 | | | | |
| 250 | 50 / 60 | 1 | 30 - 50 | | 31 - 50 | --- | 3000 | --- | --- | 5000 | 1500 | TC1,2, OL0,U1 | TC1,2, OL0,U1 | | | | |
| | | | 3 | | 0.10 - 30 | --- | 5000 ³ | --- | 3000 | 1500 | 3000 | 1500 | TC1,2, OL1,C1 | TC1,2, OL1,C1 | | | |
| SHUNT | 80 | DC | | --- | 0.10 - 30 | --- | --- | 7500 | 3000 | 1500 | 3000 | 1500 | TC1,2, OL1,U1 | TC1,2, OL1,U1 | | | |
| | | | 0.10 - 30 | | --- | --- | 7500 | 3000 | 1500 | 3000 | 1500 | TC1,2, OL1,U1 | TC1,2, OL1,U1 | | | | |
| | 250 | 50 / 60 | 1 | 0.10 - 30 | --- | --- | 3000 | 3000 | 1500 | 5000 | 1500 | TC1,2, OL1,U1 | TC1,2, OL1,U1 | | | | |
| | | | | 30 - 50 | 31 - 50 | --- | 3000 | --- | --- | 5000 | 1500 | TC1,2, OL0,U1 | TC1,2, OL0,U1 | | | | |
| | | | 3 | 0.10 - 30 | --- | 5000 ³ | --- | 3000 | 1500 | 3000 | 1500 | TC1,2, OL1,C1 | TC1,2, OL1,C1 | | | | |
| | | | | 31 - 50 | --- | 2000 ² | --- | --- | --- | 3000 | 1500 | TC1,2, OL1,C1 | TC1,2, OL1,C1 | | | | |

Notes:

- 1 General Purpose Ratings for UL/CSA Only.
- 2 Requires branch circuit backup with a UL LISTED Type K5 or RK5 fuse (15A minimum) at no more than 4 times the rating of the protector.
- 3 Same as note 1, except that backup fuse is limited to 80 A maximum.

Table C: Lists UL Recognized, CSA Certified configurations and performance capabilities as Protectors, Supplementary for Marine Electrical and Fuel Systems (CCN/Guide PEQZ2, File E75596). Ignition Protected per UL 1500. UL Classified Small Craft Electrical Devices, Marine in accordance with ISO 8846 (CCN/Guide UZMK, File MQ1515) as Marine Supplementary Protectors.

| B-SERIES TABLE C: UL1500 (Marine Ignition Protected) | | | | | | | |
|--|-----------------|-----------|----------------|----------------|-------------------------------|-------------------|--------------|
| CIRCUIT CONFIGURATION | VOLTAGE | | | CURRENT RATING | SHORT CIRCUIT CAPACITY (AMPS) | APPLICATION CODES | |
| | MAX. RATING | FREQUENCY | PHASE | FULL LOAD AMPS | WITHOUT BACKUP FUSE | UL | CSA |
| SERIES | 14 ¹ | DC | --- | 0.02 - 50 | 5000 | TC1,2,OL1,U1 | TC1,2,OL1,U1 |
| | 32 ¹ | DC | --- | 0.02 - 50 | 5000 | TC1,2,OL1,U2 | TC1,2,OL1,U2 |
| | 65 | DC | --- | 0.02 - 50 | 3000 | TC1,2,OL1,U1 | TC1,2,OL1,U1 |
| | 125 / 250 | 50 / 60 | 1 ² | 0.02 - 50 | 1500 | TC1,2,OL1,U1 | TC1,2,OL1,U1 |
| | 250 | 50 / 60 | 1 | 0.02 - 30 | 1000 | TC1,2,OL1,U1 | TC1,2,OL1,U1 |

Notes:

- 1 Available with special catalog number only (consult factory).
- 2 2 pole protector required (with one pole per power line) for: 250/125 VAC, 125/250 VAC and 208Y/120 VAC Power Systems. 1 pole protector required for: 125 VAC, 1Ø Power System.

Table D: Lists UL Listed configurations and performance capabilities as Circuit Breakers for use in Communications Equipment (CCN/Guide DITT, File E189195), under UL489A

| B-SERIES TABLE D: UL489A (COMMUNICATIONS EQUIPMENT) | | | | |
|---|-------------|-----------|----------------------|------------------------------|
| CIRCUIT CONFIGURATION | VOLTAGE | | CURRENT RATING | INTERRUPTING CAPACITY (AMPS) |
| | MAX. RATING | FREQUENCY | GENERAL PURPOSE AMPS | WITHOUT BACKUP FUSE |
| SERIES | 80 | DC | 0.10 - 50 | 5000 |
| | 80 | DC | 60 - 90 ¹ | 5000 |

Notes:
1 Parallel Pole Construction

Table E: Lists UL Listed (489) configuration and performance capabilities as a Molded Case Circuit Breaker.

| B SERIES TABLE E : UL489 LISTED BRANCH CIRCUIT BREAKERS | | | | | | |
|---|-------------|-----------|-------|----------------|------------------------------|---|
| CIRCUIT CONFIGURATION | VOLTAGE | | | CURRENT RATING | INTERRUPTING CAPACITY (AMPS) | CONSTRUCTION NOTES |
| | MAX. RATING | FREQUENCY | PHASE | FULL LOAD AMPS | WITHOUT BACKUP FUSE | |
| SERIES | 120 | 50 / 60 | 1 | 0.10 - 30 | 5,000 | 1 Pole |
| | 120 / 240 | 50 / 60 | 1 | 0.10 - 30 | 5,000 | 2 Poles |
| | 120 / 240 | 50 / 60 | 1 | 0.10 - 30 | 5,000 | 2 or 3 Poles (1 Pole of a 3 Pole Unit is for Neutral Break) |
| SHUNT TRIP DUAL COIL | 120 | 50 / 60 | 1 | 0.10 - 30 | 5,000 | 1 Pole |
| | 120 / 240 | 50 / 60 | 1 | 0.10 - 30 | 5,000 | 2 Poles |
| | 120 / 240 | 50 / 60 | 1 | 0.10 - 30 | 5,000 | 2 or 3 Poles (1 Pole of a 3 Pole Unit is for Neutral Break) |

Agency Certifications

UL Recognized

UL Standard 1077



Component Recognition Program as Protectors Supplementary (Guide CCN/QVNU2, File E75596)

CSA Accepted



Component Supplementary Protector under Class 3215 30, File 047848 0 000 CSA Standard C22.2 No. 235

UL Standard 508



Switches, Industrial Control (Guide CCN/NRNT2, File E148683)

TUV Certified



EN60934, under License No. R72040875

UL Standard 1500



Protectors, Supplementary for Marine Electrical & Fuel Systems (Guide PEQZ2, File E75596) Ignition Protection

VDE Certified



EN60934, VDE 0642 under File No. 10537

UL Listed

UL Standard 489



Circuit Breakers, Molded Case, (Guide DIVQ, File E129899)

UL Standard 489A

Communications Equipment (Guide CCN/DITT, File E189195)



1 Series 2 Actuator 3 Poles 4 Circuit 5 Aux/Alarm Switch 6 Frequency & Delay 7 Current Rating 8 Terminal 9 Actuator Color 10 Mounting/Barriers 11 Agency Approval

1 SERIES
B

2 ACTUATOR
A Handle, one per pole
B Handle, one per multipole unit
S Mid-Trip Handle, one per pole
T Mid-Trip Handle, one per pole & Alarm Switch

3 POLES
1 One 2 Two 3 Three 4 Four 5 Five 6 Six

4 CIRCUIT
A² Switch Only (No Coil)
B Series Trip (Current)
C Series Trip (Voltage)
D³ Shunt Trip (Current)
E³ Shunt Trip (Voltage)
F³ Relay Trip (Current)
G³ Relay Trip (Voltage)
H^{3,4} Dual Coil with Shunt Trip Voltage Coil
H^{3,4} Dual Coil with Shunt Trip Voltage Coil (side terminal)
K^{3,4} Dual Coil with Relay Trip Voltage Coil

5 AUXILIARY/ALARM SWITCH⁵
0 w/o Aux Switch
1 S.P.D.T., 0.093 Q.C. Term.
2 S.P.D.T., 0.110 Q.C. Term.
3 S.P.D.T., 0.139 Solder Lug
4 S.P.D.T., 0.110 Q.C. Term. (Gold Contacts)
5 S.P.S.T., 0.093 Q.C. Term. (Gold Contacts)
6 S.P.S.T., 0.139 Solder Lug
7 S.P.S.T., 0.110 Q.C. Term. (Gold Contacts)
8 S.P.S.T., 0.187 Q.C. Term.
9 S.P.D.T., 0.187 Q.C. Term.

6 FREQUENCY & DELAY
03² DC 50/60Hz, Switch Only 30 DC, 50/60Hz Instantaneous
10⁶ DC Instantaneous 31 DC, 50/60Hz Ultra Short
11 DC Ultra Short 32 DC, 50/60Hz Short
12 DC Short 34 DC, 50/60Hz Medium
14 DC Medium 36 DC, 50/60Hz Long
16 DC Long 42⁷ 50/60Hz Short, Hi-Inrush
20⁶ 50/60Hz Instantaneous 44⁷ 50/60Hz Medium, Hi-Inrush
21 50/60Hz Ultra Short 46⁷ 50/60Hz Long, Hi-Inrush
22 50/60Hz Short 52⁷ DC, Short, Hi-Inrush
24 50/60Hz Medium 54⁷ DC, Medium, Hi-Inrush
26 50/60Hz Long 56⁷ DC, Long, Hi-Inrush

- Notes:
- Actuator Code:
A: Handle tie pin spacer(s) and retainers provided unassembled with multi-pole units.
B: Handle location as viewed from front of breaker:
2 pole - left pole 3 pole - center pole
4 pole - two handles at center poles 5 pole - three handles at center poles
6 pole - four handles at center poles
S: Handle moves to mid-position only upon electrical trip of the breaker. Available with circuit codes B, C, D, E, F, G, H and K.
T: Handle moves to mid-position and alarm switch activates only upon electrical trip of the breaker. Available with circuit codes B & C.
 - Switch Only circuits, rated up to 50 amps and 6 poles, and only available with VDE Certification when tied to a protected pole (Circuit Code B, C, D or H), For .02 to 30 amps, select Current Code 630. For 35 - 50 amps, select Current Code 650.
 - Available with Terminal Codes 1, 2 and 3. Current Rating limited to 30 amps maximum.
 - Consult factory for available Dual Coil options, as special catalog number is required. With Shunt construction, Dual Coils will trip instantaneously on line voltage. Dual coils require 30VA minimum power to trip and are rated for intermittent duty only.
 - Auxiliary Switch breakers with Series Trip and Switch Only circuits. On multi-pole breakers, one aux. switch is supplied, mounted in the extreme right pole.
 - Separate pole type voltage coils not rated for continuous duty. Available only with delay codes 10 and 20.
 - Available with Circuit Codes B & D only. VDE Certified to 30 amps. UL Recognized and CSA Accepted to 50 amps.
 - VDE Certification available with single pole breakers with DC Delay only. UL Recognition and CSA Accepted available in one and two pole breakers.
 - Screw Terminals are recommended on ratings greater than 20 amps. Ratings over 30 amps are only available with Terminal Codes 5, 9, G, H, J, K, M and Q.
 - VDE Certification up to 25 amps and UL Recognition and CSA Acceptance up to 30 amps, but not recommended over 20 amps.
 - Terminal Codes 3, 5 E and H (Bus Type) with VDE, are supplied with Lock Washers, and Terminal Code M (M6 Threaded Stud) with VDE is supplied with Lock and Flat Washers. These breakers are only VDE Certified when the washers are used.
 - VDE Cert. available up to 12 amps. UL Rec. & CSA Acceptance available up to 30 amps.
 - Single pole breakers with Terminal Code P (Printed Circuit Board) are available up to 30 amps with VDE Certification and 50 amps with UL Recognition and CSA Acceptance, with Circuit Codes A, B and C. Two pole breakers with Terminal Code P (Printed Circuit Board) are available up to 40 amps with UL Recognition and CSA Acceptance with Circuit Codes A, B and C.
 - Available with Actuator Codes A, S and T.
 - Available with voltage coils only.
 - Terminal Code Q not available with VDE approvals.

7 CURRENT RATING (AMPERES)

| CODE | AMPERES | | | | |
|------|---------|-----|-------|-----|--------|
| 020 | 0.020 | 225 | 0.250 | 420 | 2.000 |
| 025 | 0.025 | 230 | 0.300 | 522 | 2.250 |
| 030 | 0.030 | 235 | 0.350 | 527 | 2.750 |
| 035 | 0.035 | 240 | 0.400 | 430 | 3.000 |
| 040 | 0.040 | 245 | 0.450 | 435 | 3.500 |
| 045 | 0.045 | 250 | 0.500 | 440 | 4.000 |
| 050 | 0.050 | 255 | 0.550 | 445 | 4.500 |
| 055 | 0.055 | 260 | 0.600 | 450 | 5.000 |
| 060 | 0.060 | 265 | 0.650 | 455 | 5.500 |
| 065 | 0.065 | 270 | 0.700 | 460 | 6.000 |
| 070 | 0.070 | 275 | 0.750 | 465 | 6.500 |
| 075 | 0.075 | 280 | 0.800 | 470 | 7.000 |
| 080 | 0.080 | 285 | 0.850 | 475 | 7.500 |
| 085 | 0.085 | 290 | 0.900 | 480 | 8.000 |
| 090 | 0.090 | 295 | 0.950 | 485 | 8.500 |
| 095 | 0.095 | 410 | 1.000 | 490 | 9.000 |
| 210 | 0.100 | 512 | 1.250 | 495 | 9.500 |
| 215 | 0.150 | 415 | 1.500 | 610 | 10.000 |
| 220 | 0.200 | 517 | 1.750 | 710 | 10.500 |

OR VOLTAGE COIL (NORMAL RATED VOLTAGE)⁶

| | | | | | | | |
|-----|-------|-----|-------|-----|-------|-----|--------|
| A06 | 6 DC | A32 | 32 DC | J12 | 12 AC | K65 | 65 AC |
| A12 | 12 DC | A48 | 48 DC | J18 | 18 AC | J60 | 120 AC |
| A18 | 18 DC | A65 | 65 DC | J24 | 24 AC | L40 | 240 AC |
| A24 | 24 DC | J06 | 6 AC | J48 | 48 AC | | |

8 TERMINAL⁹

| | | | |
|-----------------|--|-----------------|---------------------------------------|
| 1 ¹⁰ | Push-On 0.250 Tab (Q.C.) | G | Screw M5 (Bus Type) and 30° bend |
| 2 | Screw 8-32 w/upturned lugs | H | Screw M5 (Bus Type) |
| 3 ¹¹ | Screw 8-32 (Bus Type) | J | Screw 10-32 w/upturned lugs |
| 4 | Screw 10-32 (Bus Type) | K | Screw 10-32 Back Connect |
| 5 ¹¹ | Screw 10-32 (Bus Type) | L ¹² | 0.250 Q.C./ Solder Lug |
| 6 | Screw 8-32 w/upturned lugs and 30° bend | M ¹¹ | M6 Threaded Stud |
| 7 | Screw 8-32 (Bus Type) and 30° bend | N | Screw M4 Back Connect |
| 8 | Screw 10-32 w/upturned lugs and 30° bend | P ¹³ | Printed Circuit Board Terminals |
| 9 | Screw 10-32 (Bus Type) and 30° bend | Q ¹⁶ | Push-In Stud |
| B | Screw M5 w/upturned lugs | R | Screw M4 w/upturned lugs and 30° bend |
| C | Screw M4 w/upturned lugs | S ¹⁵ | Push-On 0.110 Tab (Q.C.) |
| E ¹¹ | Screw M4 (Bus Type) | T | Screw M4 (Bus Type) and 30° bend |
| F | Screw M5 w/upturned lugs and 30° bend | Y | Screw 8-32 Back Connect |

9 ACTUATOR COLOR & LEGEND

| Actuator Color | I-O | ON-OFF | Dual | Legend Color |
|----------------|-----|--------|------|--------------|
| White | A | B | 1 | Black |
| Black | C | D | 2 | White |
| Red | F | G | 3 | White |
| Green | H | J | 4 | White |
| Blue | K | L | 5 | White |
| Yellow | M | N | 6 | Black |
| Gray | P | Q | 7 | Black |
| Orange | R | S | 8 | Black |

10 MOUNTING/BARRIERS

| | MOUNTING STYLE | BARRIERS |
|-----------------|--|----------|
| | Threaded Insert, 2 per pole | |
| 1 | 6-32 x 0.195 inches | no |
| A | 6-32 x 0.195 inches (multi-pole units only) | yes |
| 2 | ISO M3 x 5mm | no |
| B | ISO M3 x 5mm | yes |
| | Rectangular Adapter Plate with mounting centers of 2.062 inches [52.37mm] and Threaded insert, 2 per pole | |
| 3 ¹⁴ | 6-32 x 0.225 inches | no |
| C ¹⁴ | 6-32 X 0.225 inches (multi-pole units only) | yes |
| 4 ¹⁴ | ISO M3 x 6.5mm | no |
| D ¹⁴ | ISO M3 x 6.5mm | yes |
| | Front panel Snap-In, 0.75" [19.05mm] wide bezel | |
| 5 | without Handleguard | no |
| 6 | without Handleguard (multipole only) | yes |
| | Front panel Snap-In, 0.96" wide bezel | |
| 7 | without Handleguard, 1-pole 0.96" wide; | no |
| | multipole units have .105" bezel overhang on all sides | |
| 8 | without Handleguard, 1-pole 0.96" wide; | yes |
| | (multipole only) .105" bezel overhang on all sides | |

11 AGENCY APPROVAL

| | |
|---|---|
| C | UL Recognized & CSA Accepted |
| D | VDE Certified, UL Recognized & CSA Accepted |
| E | TUV Certified, UL Recognized & CSA Accepted |
| I | UL Rec. STD 1077, UL Rec. 1500 (ignition protected), & CSA Accepted |

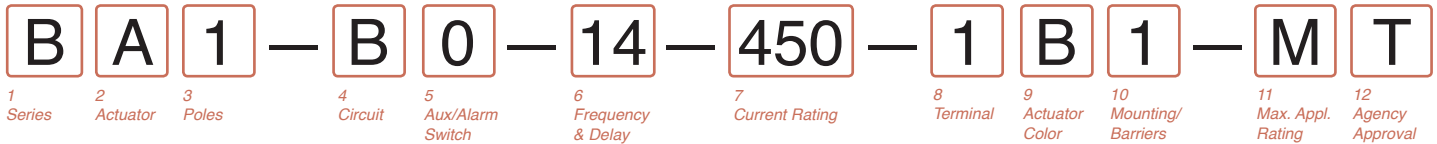

1 SERIES
B

2 ACTUATOR¹
A Handle, one per pole
B Handle, one per multipole unit
S Mid-Trip Handle, one per pole
T Mid-Trip Handle, one per pole & Alarm Switch

3 POLES²
1 One **3** Three
2 Two **4** Four

4 CIRCUIT
B Series Trip (Current)

5 AUXILIARY/ALARM SWITCH²
0 w/o Aux Switch **7** S.P.S.T., 0.110 Q.C. Term.
1 S.P.D.T., 0.093 Q.C. Term. (Gold Contacts)
2 S.P.D.T., 0.110 Q.C. Term. **8** S.P.S.T., 0.187 Q.C. Term.
3 S.P.D.T., 0.139 Solder Lug **9** S.P.D.T., 0.187 Q.C. Term.

6 FREQUENCY & DELAY⁴
11 DC Ultra Short **52** DC, Short, Hi-Inrush
12 DC Short **54** DC, Medium, Hi-Inrush
14 DC Medium **56** DC, Long, Hi-Inrush
16 DC Long

7 CURRENT RATING (AMPERES)

| CODE | AMPERES | | | | |
|------|---------|-----|-------|------------------|--------|
| 210 | 0.100 | 285 | 0.850 | 455 | 5.500 |
| 215 | 0.150 | 290 | 0.900 | 460 | 6.000 |
| 220 | 0.200 | 295 | 0.950 | 465 | 6.500 |
| 225 | 0.250 | 410 | 1.000 | 470 | 7.000 |
| 230 | 0.300 | 512 | 1.250 | 475 | 7.500 |
| 235 | 0.350 | 415 | 1.500 | 480 | 8.000 |
| 240 | 0.400 | 517 | 1.750 | 485 | 8.500 |
| 245 | 0.450 | 420 | 2.000 | 490 | 9.000 |
| 250 | 0.500 | 522 | 2.250 | 495 | 9.500 |
| 255 | 0.550 | 527 | 2.750 | 610 | 10.000 |
| 260 | 0.600 | 430 | 3.000 | 710 | 10.500 |
| 265 | 0.650 | 435 | 3.500 | 611 | 11.000 |
| 270 | 0.700 | 440 | 4.000 | 711 | 11.500 |
| 275 | 0.750 | 445 | 4.500 | 612 | 12.000 |
| 280 | 0.800 | 450 | 5.000 | 712 | 12.500 |
| | | | | 613 | 13.000 |
| | | | | 614 | 14.000 |
| | | | | 615 | 15.000 |
| | | | | 616 | 16.000 |
| | | | | 617 | 17.000 |
| | | | | 618 | 18.000 |
| | | | | 620 | 20.000 |
| | | | | 622 | 22.000 |
| | | | | 624 | 24.000 |
| | | | | 625 | 25.000 |
| | | | | 630 | 30.000 |
| | | | | 635 ³ | 35.000 |
| | | | | 640 ³ | 40.000 |
| | | | | 645 ³ | 45.000 |
| | | | | 650 ³ | 50.000 |

8 TERMINAL⁴
1⁵ Push-On 0.250 Tab (Q.C.) **B** Screw M5 w/upturned lugs
2 Screw 8-32 w/upturned lugs **F** Screw M5 w/upturned lugs and 30° bend
3⁶ Screw 8-32 (Bus Type) **G** Screw M5 (Bus Type) and 30° bend
4 Screw 10-32 w/upturned lugs **H** Screw M5 (Bus Type)
5⁶ Screw 10-32 (Bus Type) **J** Screw M5 Back Connect
6 Screw 8-32 w/upturned lugs and 30° bend **K** Screw 10-32 Back Connect
7 Screw 8-32 (Bus Type) and 30° bend **M⁹** M6 Threaded Stud
8 Screw 10-32 w/upturned lugs and 30° bend **N** Screw M4 Back Connect
9 Screw 10-32 (Bus Type) and 30° bend **P⁷** Printed Circuit Board Terminals
Q⁸ Push-In Stud
Y Screw 8-32 Back Connect

9 ACTUATOR COLOR & LEGEND

| Actuator Color | ON-OFF | Dual | Legend Color |
|----------------|----------|----------|--------------|
| White | B | 1 | Black |
| Black | D | 2 | White |
| Red | G | 3 | White |
| Green | J | 4 | White |
| Blue | L | 5 | White |
| Yellow | N | 6 | Black |
| Gray | Q | 7 | Black |
| Orange | S | 8 | Black |

10 MOUNTING/BARRIERS

| | MOUNTING STYLE | BARRIERS |
|----------|--|----------|
| | Threaded Insert, 2 per pole | |
| 1 | 6-32 x 0.195 inches | no |
| A | 6-32 x 0.195 inches (multi-pole units only) | yes |
| 2 | ISO M3 x 5mm | no |
| B | ISO M3 x 5mm | yes |
| | Rectangular Adapter Plate with mounting centers of 2.062 inches [52.37mm] and Threaded insert, 2 per pole | |
| 3 | 6-32 x 0.225 inches | no |
| C | 6-32 X 0.225 inches (multi-pole units only) | yes |
| 4 | ISO M3 x 6.5mm | no |
| D | ISO M3 x 6.5mm | yes |
| | Front panel Snap-In, 0.75" [19.05mm] wide bezel | |
| 5 | without Handleguard | no |
| 6 | without Handleguard (multipole only) | yes |
| | Front panel Snap-In, 0.96" wide bezel | |
| 7 | without Handleguard, 1-pole 0.96" wide; | no |
| | multipole units have .105" bezel overhang on all sides | |
| 8 | without Handleguard, 1-pole 0.96" wide; | yes |
| | (multipole only) .105" bezel overhang on all sides | |

11 MAXIMUM APPLICATION RATING
M 80 DC

12 AGENCY APPROVAL
T UL489A LISTED
K UL489A LISTED, VDE CERTIFIED
J UL489A LISTED, TUV CERTIFIED

- Notes:
- Actuator Code:
 A: Handle tie pin spacer(s) and retainers provided unassembled with multi-pole units.
 S: Handle moves to mid-position only upon electrical trip of the breaker.
 T: Handle moves to mid-position and alarm switch activates only upon electrical trip of the breaker.
 - On multi-pole breakers, one auxiliary switch is supplied, mounted in the extreme right pole.
 - VDE Certification available with single pole breakers only. UL489A Listing available with one and two pole breakers.
 - Screw Terminals are recommended on ratings greater than 20 amps. Ratings over 30 amps are only available with Terminal Codes 5, 9, G, H, J, K, M and Q.
 - Terminal Code 1 (Push-On) available up to 25 amps with TUV or VDE Certification and 30 amps with UL489A Listing, but is not recommended over 20 amps.
 - Terminal Codes 3, 5 and H (Bus Type) with TUV or VDE, are supplied with Lock Washers, and Terminal Code M (M6 Threaded Stud) with TUV or VDE is supplied with Lock and Flat Washers. These breakers are only TUV or VDE Certified when the washers are used.
 - Single pole breakers with Terminal Code P (Printed Circuit Board) are available up to 30 amps with VDE Certification and 50 amps with UL489A Listing.
 - Terminal Code Q not available with VDE approvals.

| | CIRCUIT SCHEMATIC | | | | CIRCUIT CODE | AUX SWITCH CODE | CIRCUIT SCHEMATIC | | | | CIRCUIT CODE | AUX SWITCH CODE |
|---|-----------------------|--|-----|--|--------------|-----------------|-------------------|--|-----|---|--------------|-----------------|
| | ANSI | | IEC | | | | ANSI | | IEC | | | |
| | SWITCH ONLY (NO COIL) | | | | | | SERIES TRIP | | | | | |
| SERIES TRIP (2 TERM'S.) | | | | | A | O | | | B | C | O | |
| SERIES TRIP W AUX SWITCH (5 TERM'S.) | | | | | A | 2 3 4 | | | B | C | 2 3 4 | |
| SHUNT TRIP (3 TERM'S.) | | | | | D | E | | | H | | O | |
| RELAY TRIP (4 TERM'S.) | | | | | F | G | | | K | | O | |

| HANDLE POSITION VS. AUX/ALARM SWITCH MODE | | | | | | |
|---|-----------------|------------------|-----------------|-------------------|-----------------|-------------------------------------|
| CIRCUIT BREAKER MODE | STANDARD C/B | | MID TRIP C/B | | MID TRIP C/B | |
| | HANDLE POSITION | AUX. SWITCH MODE | HANDLE POSITION | ALARM SWITCH MODE | HANDLE POSITION | AUX. SWITCH MODE (w/o ALARM SWITCH) |
| OFF | | | | | | |
| ON | | | | | | |
| ELECTRICAL TRIP | | | | | | |

- Notes:
- 1 All dimensions are in inches [millimeters].
 - 2 Tolerance ±.020 [.51] unless otherwise specified.
 - 3 Alarm Switch available with .110 x .020 Q.C. & Solder Lug Terminals Only.

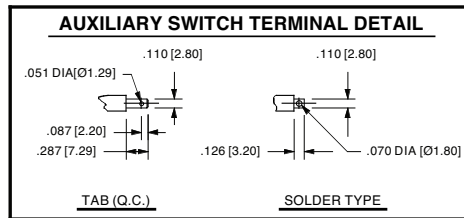

**TABLE A
TIGHTENING TORQUE
SPECIFICATIONS**

| THREAD SIZE | TORQUE |
|-----------------------------------|---------------------------|
| #6-32 & M3 MOUNTING HARDWARE | 7-9 IN-LBS [0.8-1.0 NM] |
| #8-32 & M4 THREAD TERMINAL SCREW | 12-15 IN-LBS [1.4-1.7 NM] |
| #10-32 & M5 THREAD TERMINAL SCREW | 15-20 IN-LBS [1.7-2.3 NM] |



TABLE B

| TERMINAL DESCRIPTION | | DEPTH BEHIND PANEL |
|--------------------------|-----------------------------|--------------------|
| MAIN | TAB (Q.C.) | 2.090 [53.09] |
| | SCREW TYPE | 2.122 [53.90] |
| SHUNT, RELAY & DUAL COIL | TAB (Q.C.) | 2.612 [66.35] |
| | SCREW #8-32 W/UPTURNED LUGS | 2.644 [67.16] |
| AUX. SWITCH* | TAB (Q.C.) .110 x .020 | 2.537 [64.44] |
| | SOLDER TYPE | 2.348 [59.64] |

* AVAILABLE ON SERIES TRIP AND SWITCH ONLY CIRCUITS. WHEN CALLED FOR ON MULTI-POLE UNITS, ONLY ONE AUX. SWITCH IS NORMALLY SUPPLIED, AS SHOWN IN MULTI-POLE IDENTIFICATION SCHEME.

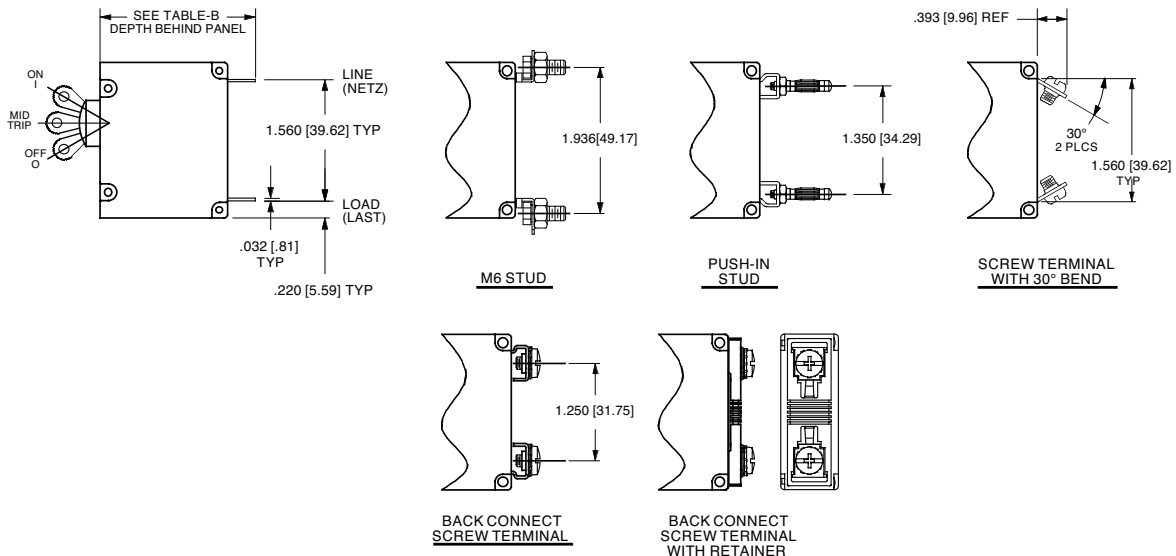

Notes:

- 1 All dimensions are in inches [millimeters].
- 2 Tolerance ±.020 [.51] unless otherwise specified.



TAB (Q.C.) TYPE TERMINALS IN SERIES TRIP CIRCUIT CONFIGURATION SHOWN. FOR OTHER CONFIGURATIONS, SEE CIRCUIT AND TERMINAL DRAWINGS.

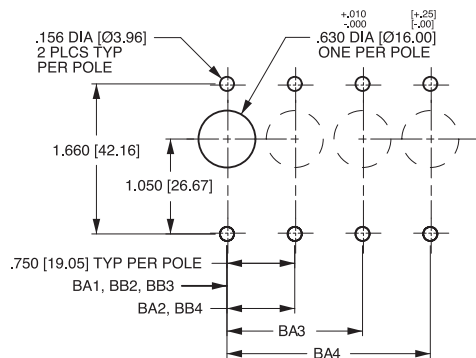

PANEL CUTOUT DETAIL
TOLERANCES ±.005 [±.12]

Notes:

- 1 All dimensions are in inches [millimeters].
- 2 Tolerance ± 0.20 [.51] unless otherwise specified.

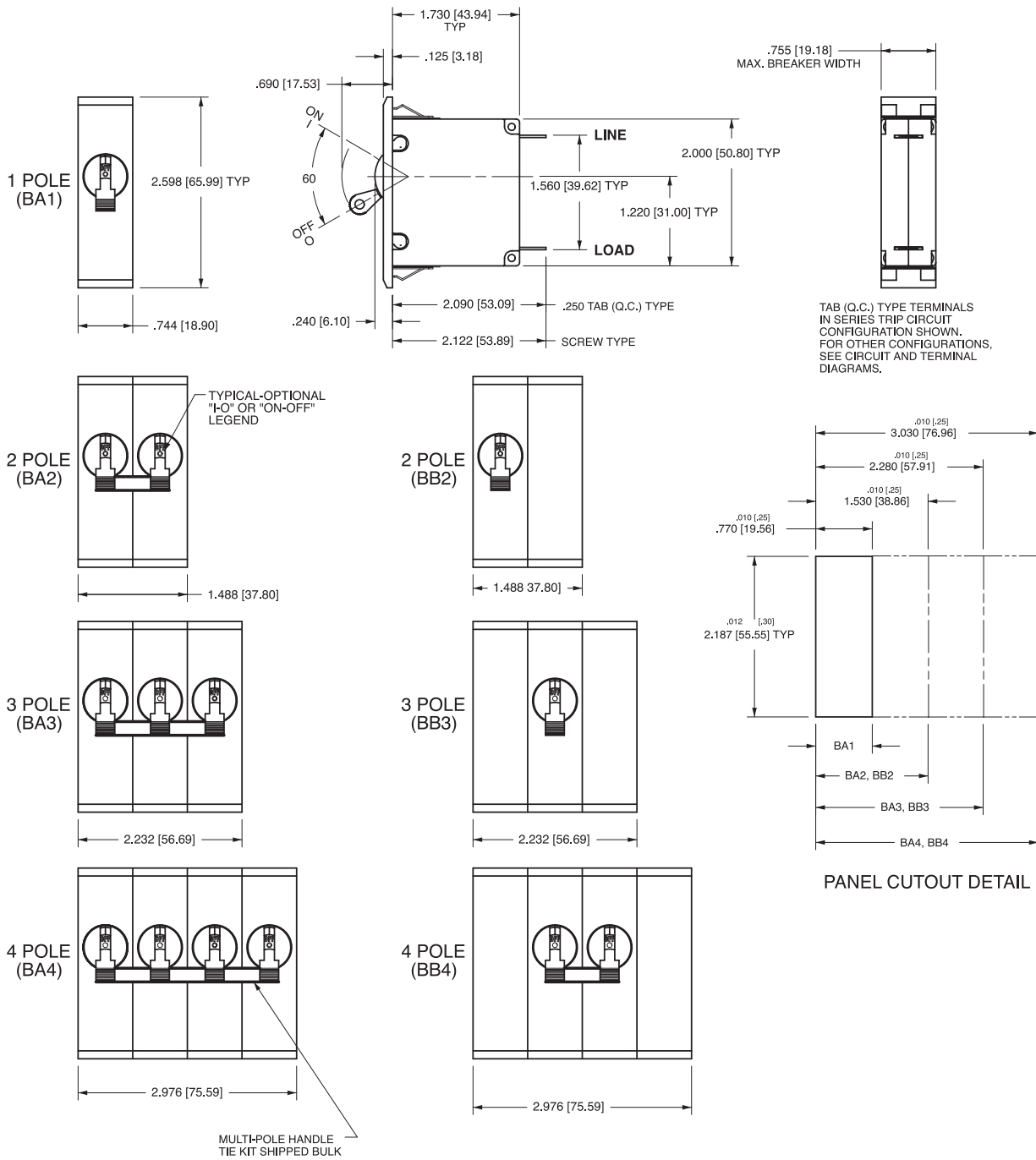

Notes:

- 1 All dimensions are in inches [millimeters].
- 2 Recommended panel thickness: .040 [1.02] to .100 [2.54].
- 3 Tolerance ± 0.020 [0.51] unless otherwise specified.

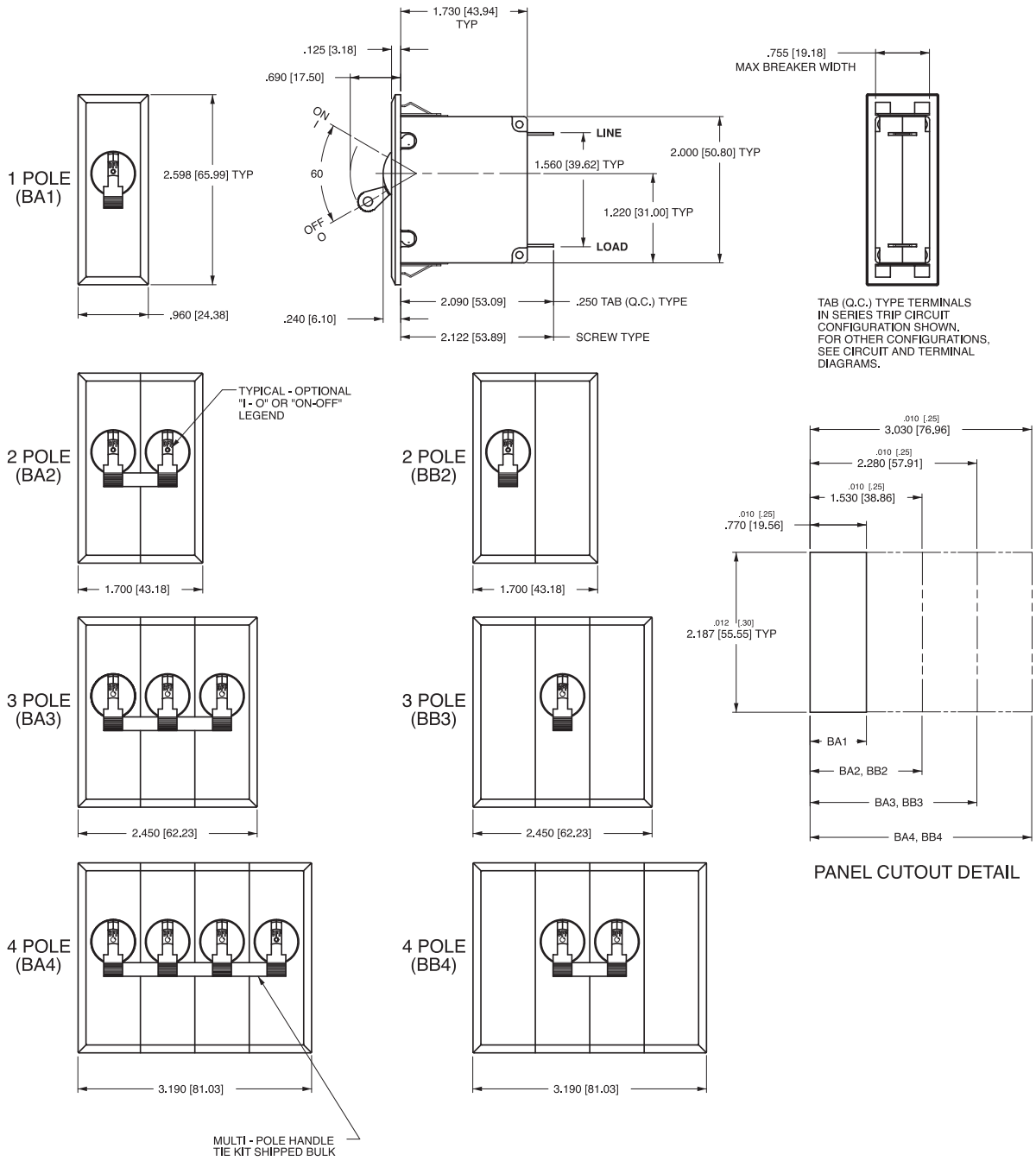

Notes:

- 1 All dimensions are in inches [millimeters].
- 2 Recommended panel thickness: .040 [1.02] to .100 [2.54].
- 3 Tolerance ± 0.020 [.51] unless otherwise specified.

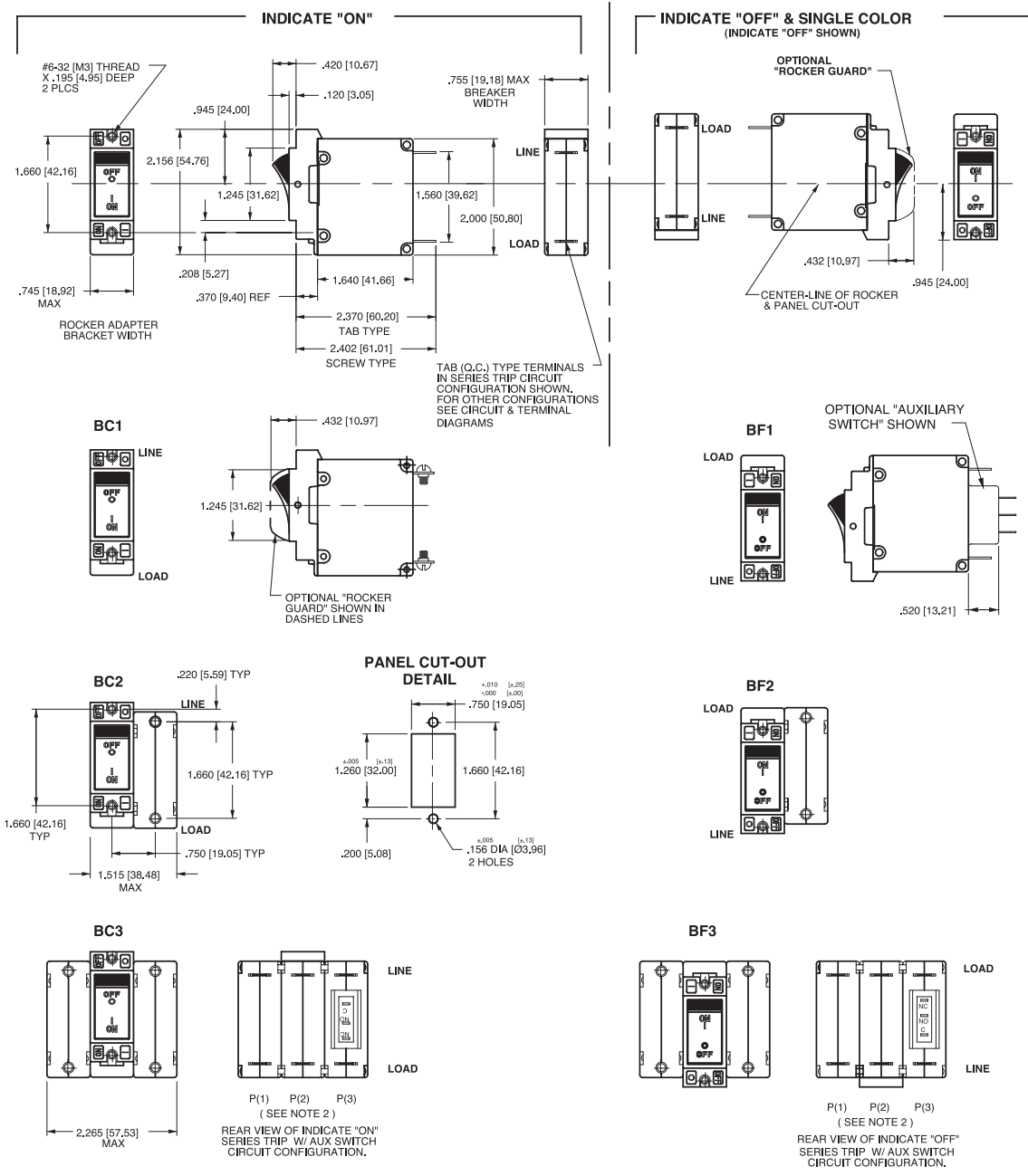

Notes:

- 1 Dimensions apply to all variations shown. Notice that circuit breaker line & load terminal orientation on indicate "OFF" is opposite of indicate "ON".
- 2 For pole orientation with horizontal legend, rotate front view clockwise 90°.
- 3 All dimensions are in inches [millimeters].
- 4 Tolerance $\pm .020$ [51] unless otherwise specified.

INDICATE "OFF" & SINGLE COLOR
(INDICATE "OFF" SHOWN)

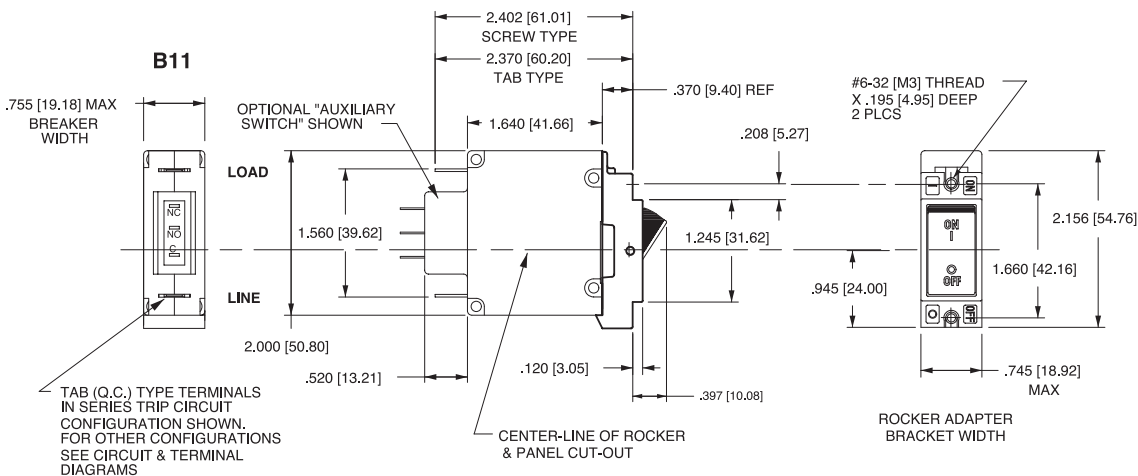

PUSH-TO-RESET ACTUATOR



ACTUATOR SIDE VIEW
(SURFACE CONTOURS)



Notes:

- 1 All dimensions are in inches [millimeters].
- 2 For pole orientation with horizontal legend, rotate front view clockwise 90°.
- 3 Tolerance ±.020 [.51] unless otherwise specified.



Notes:

- 1 All dimensions are in inches [millimeters].
- 2 For pole orientation with horizontal legend, rotate front view clockwise 90°.
- 3 Tolerance ±.010 [0.25] unless otherwise specified.

REV_CB_B_0812



Компания «ЭлектроПласт» предлагает заключение долгосрочных отношений при поставках импортных электронных компонентов на взаимовыгодных условиях!

Наши преимущества:

- Оперативные поставки широкого спектра электронных компонентов отечественного и импортного производства напрямую от производителей и с крупнейших мировых складов;
- Поставка более 17-ти миллионов наименований электронных компонентов;
- Поставка сложных, дефицитных, либо снятых с производства позиций;
- Оперативные сроки поставки под заказ (от 5 рабочих дней);
- Экспресс доставка в любую точку России;
- Техническая поддержка проекта, помощь в подборе аналогов, поставка прототипов;
- Система менеджмента качества сертифицирована по Международному стандарту ISO 9001;
- Лицензия ФСБ на осуществление работ с использованием сведений, составляющих государственную тайну;
- Поставка специализированных компонентов (Xilinx, Altera, Analog Devices, Intersil, Interpoint, Microsemi, Aeroflex, Peregrine, Syfer, Eurofarad, Texas Instrument, Miteq, Cobham, E2V, MA-COM, Hittite, Mini-Circuits, General Dynamics и др.);

Помимо этого, одним из направлений компании «ЭлектроПласт» является направление «Источники питания». Мы предлагаем Вам помощь Конструкторского отдела:

- Подбор оптимального решения, техническое обоснование при выборе компонента;
- Подбор аналогов;
- Консультации по применению компонента;
- Поставка образцов и прототипов;
- Техническая поддержка проекта;
- Защита от снятия компонента с производства.



Как с нами связаться

Телефон: 8 (812) 309 58 32 (многоканальный)

Факс: 8 (812) 320-02-42

Электронная почта: org@eplast1.ru

Адрес: 198099, г. Санкт-Петербург, ул. Калинина, дом 2, корпус 4, литера А.