

DOGS GRAPHIC SERIES

06.2013

102x64 DOTS



EA DOGSI02B-6 +
EA LED39x41-W



EA DOGSI02W-6 +
EA LED39x41-W



EA DOGSI02W-6 +
EA LED39x41-A

available in low quantities !
flat: 5.5mm with LED b./l. mounted

TECHNICAL DATA

- * HIGH-CONTRAST LCD SUPERTWIST DISPLAY (STN AND FSTN) WITH 10µm DOT GAP
- * OPTIONAL LED BACKLIGHTS IN VARIOUS COLORS
- * 102x64 PIXELS (CORRESPONDS TO 8x17 CHARACTERS OR 4x12 LARGE CHARACTERS)
- * UC1701 CONTROLLER WITH SPI (4-WIRE) INTERFACE
- * POWER SUPPLY: SINGLE SUPPLY 2.5V TO 3.3V (TYPICALLY 250µA)
- * NO ADDITIONAL VOLTAGES REQUIRED
- * OPERATING TEMPERATURE RANGE -20°C TO +70°C (STORAGE -30°C TO +80°C)
- * LED BACKLIGHTING 5mA TO 80mA
- * NO MOUNTING REQUIRED: SIMPLY SOLDER ONTO PCB

ORDERING CODE

GRAPHICS DISPLAY, 102x64, 39x41mm

x: *W* = white background (FSTN pos. transfective)

B = blue background (STN neg. transmissive)

N = superwhite background (FSTN pos. reflective, cannot be backlit)

LED BACKLIGHT, WHITE

LED BACKLIGHT, AMBER

LED BACKLIGHT, DUO COLOR GREEN/RED

EA DOGSI02x-6

EA LED39X41-W

EA LED39X41-A

EA LED39X41-GR

ACCESSORIES

USB TEST BOARD FOR PC (WINDOWS 2000, XP, VISTA)

TOUCH PANEL, 4-WIRE, ANALOG, STICK-ON

ZIF CONNECTOR FOR TOUCH PANEL, BOTTOM CONTACT

10 CHARACTER SETS e.g. 6x8,8x8,8x16,CYRILLIC, FONT EDITOR

SOCKET 4.8mm HEIGHT (2 pcs. ARE NECESSARY)

EA 9780-2USB

EA TOUCH102-1

EA WF100-04S

EA USBSTICK-FONT

EA FL-14P

**ELECTRONIC
ASSEMBLY**

making things easy

PINOUT

The EADOGS102, a 102x64-pixel graphics display, is a new addition to ELECTRONICASSEMBLY's EA DOG series. It, too, has pins that allow it to be mounted quickly and easily.



Pin	Symbol	Level	Function	Pin	Symbol	Level	Function
1	NC		(A1+: LED backlight)	15	VLCD	-	Power LC Drive
2	NC		(C1-: LED backlight)	16	VB1-	-	Voltage Converter
3				17	VB0-	-	Voltage Converter
4				18	VB0+	-	Voltage Converter
5				19	VB1+	-	Voltage Converter
6				20	VSS	L	Power Supply 0V (GND)
7				21	VSS	L	Power Supply 0V (GND)
8				22	VDD2/3	H	Power Supply +2,5..3,3V
9				23	VDD1	H	Power Supply +2,5..3,3V
10				24	SDA	H / L	Data in (SPI: MOSI)
11				25	SCK	H / L	Clock (SPI: CLK)
12				26	CD	H / L	L= Command, H= Data
13	NC		(C2-: LED backlight)	27	RST	L	Reset (active low)
14	NC		(A2+: LED backlight)	28	CS0	L	Chip Select (active low)

CONTRAST ADJUSTMENT

The contrast can be set by means of a command for all the displays in the EA DOG series. The contrast setting of the display must be set once by the software, and is then kept constant throughout the entire operating temperature range (-20..+70°C), thanks to the integrated temperature compensation.

3 DIFFERENT TECHNOLOGIES

See below for an overview of available technologies, combinations with available backlights and their usability:

display type	technology	optional backlight	readability	display color non backlighted	display color with backlighted	recommende backlight color
	FSTN pos. transfective	it's fine with and without backlight	readable even without backlight	black on white	black on backlight color	all
	STN neg. blue transmissive	usage only with backlight	---	---	white backlight on blue background	white
	FSTN pos. white reflective	no backlight possible	finest readable without backlight	black on white	---	---

LED-BACKLIGHT

3 different variants are available for individual backlighting: white, amber and a duo-color green/red version.

There are 2 separate LED paths available for each monochrome backlight that can be switched in parallel or in series to suit the system voltage. This means that most backlights can be run at either 3.3 V or a higher voltage. To operate the backlight, we recommend a current source (e.g. CAT4238TD) or an external series resistor to limit the current. This can be calculated from $R=U/I$; you can find the values in the table on the right. To prolong the life of the backlights, we recommend that you use a current source.

The operating life of the amber and green/red backlights is 100,000 hours. The life of the white backlight is considerably shorter. We recommend that you dim these or switch them off whenever possible.

Important:

Do never connect the backlight LEDs directly to a 5 V/3.3 V supply as this will immediately destroy the LEDs. Always use a current source. Please note that derating applies at temperatures exceeding +25°C.

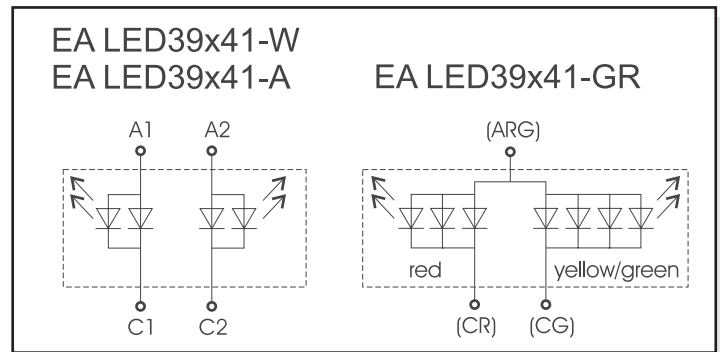

amber EA LED39x41-A	Forward voltage	Current max.	Limiting resistor	
			@ 3,3 V	@ 5 V
Connected in parallel	2,2 V	80 mA	15 ohm	36 ohm
Connected in series	4,4 V	40 mA	CAT4238	15 ohm

white EA LED39x41-W	Forward voltage	Current max.	Limiting resistor	
			@ 3,3 V	@ 5 V
Connected in parallel	3,3 V	60 mA	0 ohm	28 ohm
Connected in series	6,6 V	30 mA	use CAT4238	

green/red EA LED39x41-GR	Forward voltage	Current max.	Limiting resistor	
			@ 3,3 V	@ 5 V
red path (ARG/CR)	1,9 V	60 mA	24 ohm	51 ohm
green path (ARG/CG)	2,0 V	80 mA	18 ohm	39 ohm

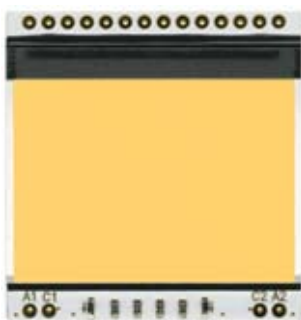

EA LED39x41-A Amber



EA LED39x41-W White

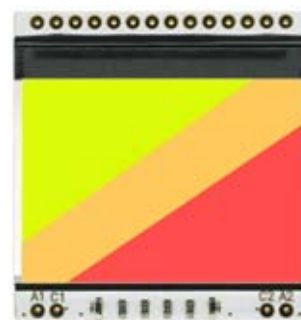

EA LED39x41-GR Green/Red

If you see black and white pictures on this page but you want to see the colors of the displays, you can download a full-colored version of this document at <http://www.lcd-module.de/eng/pdf/grafik/dogs102-6e.pdf>

APPLICATION EXAMPLE

3 additional capacitors are required for +2,5V..+3.3V operation.

Current consumption typ. 250µA

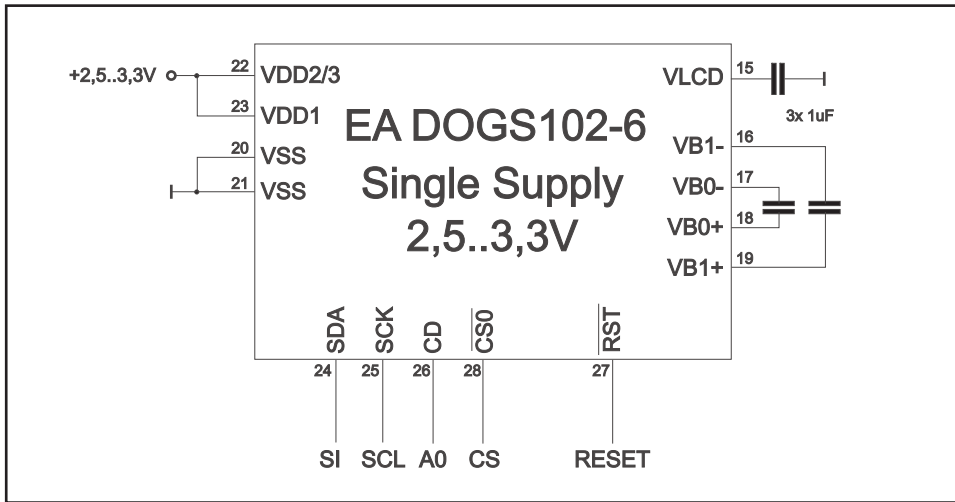

DATA TRANSFER

Data transfer is unidirectional. That means that data can only be written; it cannot be read again. In contrast to other displays, a busy query is not necessary with this display. The transmission follows SPI-mode 3, with MSB first.

The clock-pulse rate of the SCL line can be up to 33 MHz at 3.3V, depending on the supply voltage. You will find more detailed information on timing on page 41 of the datasheet of the UC1701x controller, which you will find on our website at <http://www.lcd-module.de/eng/pdf/zubehoer/uc1701.pdf>

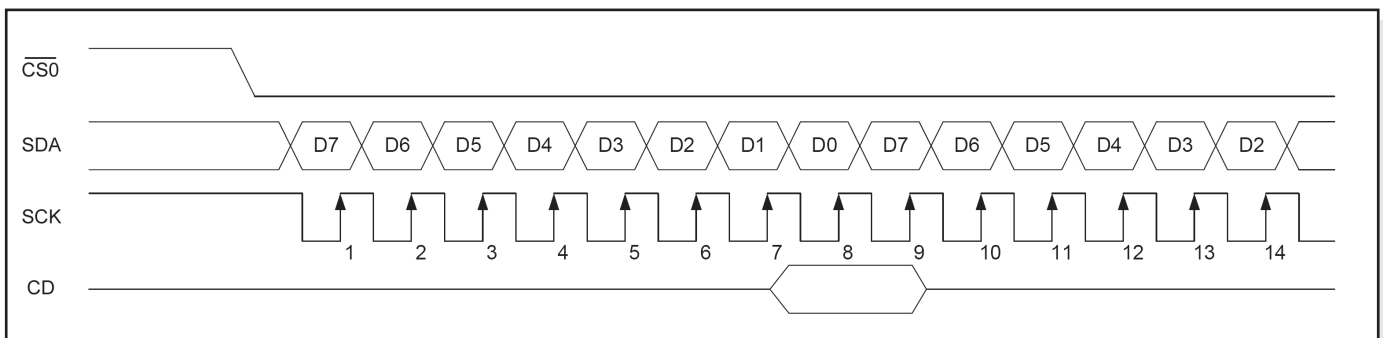

UC1701 PROGRAMMING COMMANDS

Command		Command Code								Function	
		CD	D7	D6	D5	D4	D3	D2	D1		D0
(1)	Write Data Byte	1	data bit D[7..0]								Write one byte to memory
(4)	Set Column Address LSB	0	0	0	0	0	CA[3..0]			Set the SRAM column address CA=0..131	
	Set Column Address MSB		0	0	0	1	CA[7..4]				
(5)	Set Power Control	0	0	0	1	0	1	PC[2..0]		PC0: 0=Booster OFF; 1=Booster ON PC1: 0=Regulator OFF; 1=Regulator ON PC2: 0=Follower OFF; 1=Follower ON	
(6)	Set Scroll Line	0	0	1	SL[5..0]					Set the display startline number SL=0..63	
(7)	Set Page Address	0	1	0	1	1	PA[3..0]			Set the SRAM page address PA=0..7	
(8)	Set VLCD Resistor Ratio	0	0	0	1	0	0	PC[5..3]		Configure internal resistor ratio PC=0..7	
(9)	Set Electronic Volume	0	1	0	0	0	0	0	1	Adjust contrast of LCD panel PM=0..63	
			0	0	PM[5..0]						
(10)	Set All Pixel On	0	1	0	1	0	0	1	0	C1	C1=0: show SRAM content C1=1: Set all SEG-Drivers to ON
(11)	Set Inverse Display	0	1	0	1	0	0	1	1	C0	C0=0: show normal SRAM content C0=1: show inverse SRAM content
(12)	Set Display Enable	0	1	0	1	0	1	1	1	C2	C2=0: disable Display (sleep) C2=1: enable Display (exit from sleep)
(13)	Set SEG direction	0	1	0	1	0	0	0	0	MX	MX=0: normal SEG 0..131 MX=1: mirror SEG 131..0
(14)	Set COM direction	0	1	1	0	0	MY	0	0	0	MY=0: normal COM 0..63 MY=1: mirror COM 63..0
(15)	System Reset	0	1	1	1	0	0	0	1	0	System Reset
(17)	Set LCD Bias Ratio	0	1	0	1	0	0	0	1	BR	BR: 0=1/9; 1=1/7
(25)	Set Adv. Program Control 0	0	1	1	1	1	1	0	1	0	TC: Temp. comp. 0=-0.05; 1=-0.11%/°C WC: Column wrap around 0=OFF; 1=ON WP: Page wrap around 0=OFF; 1=ON
			TC	0	0	1	0	0	WC	WP	

CHARACTER SET AND FONT EDITOR (ACCESSORY)

With the ordering code EA USBSTICK-FONT a memory stick comes with various character sets, especially made for this small display EA DOGS102-6. An import function allows additionally to use Windows fonts. With the FontEditor it is easy to generate for example Cyrillic, Greek and Arabic fonts.

The preview function shows immediately the size and style in simulation window.

When the testboard EA 9780-2USB is connected to the USB port, you can see the character (or any predefined text) live on the display !

No need to say that the export function generates a C- and Basic source code as an include file to your software.

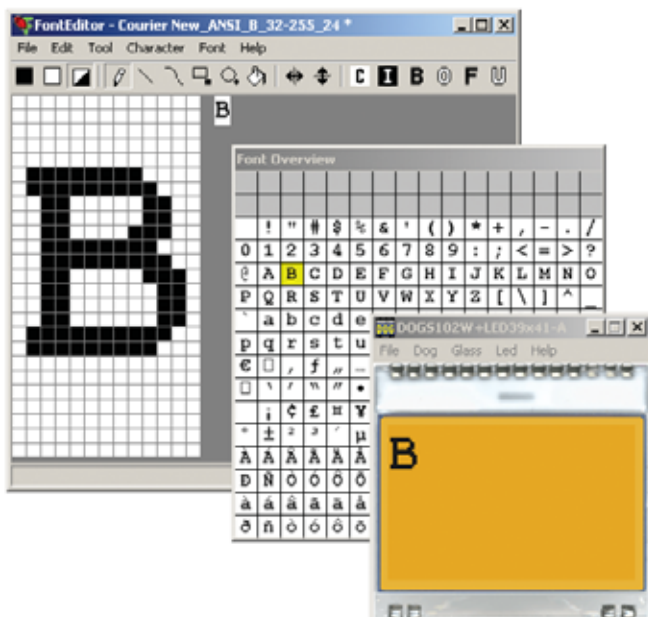

INITIALISATION EXAMPLE

Initialisation example (bottom view)												
Command	CD	D7	D6	D5	D4	D3	D2	D1	D0	Hex	Remark	
(6) Set Scroll Line	0	0	1	0	0	0	0	0	0	\$40	Display start line 0	
(13) Set SEG direction	0	1	0	1	0	0	0	0	1	\$A1	SEG reverse *)	
(14) Set COM direction	0	1	1	0	0	0	0	0	0	\$C0	Normal COM0~COM63	
(10) Set All Pixel On	0	1	0	1	0	0	1	0	0	\$A4	Disable -> Set All Pixel to ON	
(11) Set Inverse Display	0	1	0	1	0	0	1	1	0	\$A6	Display inverse off	
(17) Set LCD Bias Ratio	0	1	0	1	0	0	0	1	0	\$A2	Set Bias 1/9 (Duty 1/65)	
(5) Set Power Control	0	0	0	1	0	1	1	1	1	\$2F	Booster, Regulator and Follower on	
(8) Set VLCD Resistor Ratio	0	0	0	1	0	0	1	1	1	\$27	Set Contrast	
(9) Set Electronic Volume	0	1	0	0	0	0	0	0	1	\$81		
(25) Set Adv. Program Control 0	0	0	0	0	1	0	0	0	0	\$10	Set Temperature compensation curve to -0.11%/°C	
		1	1	1	1	1	0	1	0	\$FA		
(12) Set Display Enable	0	1	0	1	0	1	1	1	1	\$AF	Display on	

*) Make sure that for 6:00 viewing direction SEG has to be set to „reverse“ (mirrored layout) !

12:00 VIEWING ANGLE, TOP VIEW OPTION

If the display is read mostly from above (on the front of a laboratory power supply unit, for example), the preferred angle of viewing can be set to 12 o'clock. This rotates the display by 180°. A slightly different initialization setup is required for this. Also keep in mind that the leftmost column (normally numbered as 0) will now change to 30.

Initialisation example (changes for top view)												
Command	CD	D7	D6	D5	D4	D3	D2	D1	D0	Hex	Remark	
(13) Set SEG direction	0	1	0	1	0	0	0	0	0	\$A0	SEG normal	
(14) Set COM direction	0	1	1	0	0	1	0	0	0	\$C8	COM reverse COM63~COM0	

0-----Column address-----101

D0 D7	Page 0
D0 D7	Page 1
D0 D7	Page 2
D0 D7	Page 3
D0 D7	Page 4
D0 D7	Page 5
D0 D7	Page 6
D0 D7	Page 7



Orientation for 6 o'clock
(Bottom View)



Orientation for 12 o'clock
(Top View)

30-----Column address-----131

D0 D7	Page 0
D0 D7	Page 1
D0 D7	Page 2
D0 D7	Page 3
D0 D7	Page 4
D0 D7	Page 5
D0 D7	Page 6
D0 D7	Page 7

USB-TEST BOARD EA 9780-2USB

For easy startup, a USB test board is available that can be connected to a PC. A USB cable and Windows software is supplied with the product. This allows text and images (BMP) to be displayed directly on the connected display. You will find more information on the test board in the EA 9780-2USB data sheet.

SIMULATION WITH WINDOWS

A simulator window also displays the contents of the display. The software can simulate all the displays and colors even without the hardware. You can download the software free from our website. Note that all functions of the simulation software do run also without the USB board.

<http://www.lcd-module.de/deu/disk/startdog20.zip>



TOUCH PANEL EA TOUCH102-1 (OPTIONAL)

An analog touch panel is available as an accessory. It has a self-adhesive material on its rear surface and is simply stuck onto the display. The connection is made by means of a 4-pin flexible cable for a ZIF connector (e.g. EA WF100-04S)

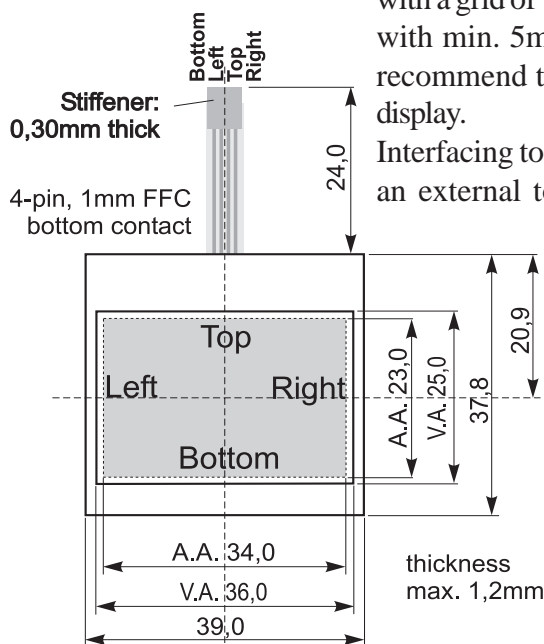

with a grid of 1.0 mm. Bending radius is defined with min. 5mm. For optimum readability we recommend that you use a backlight with the display.

Interfacing to a processor can be either done by an external touch panel controller or with a controller that is featured with analogue input. The touch panel is similar to a potentiometer: connecting a voltage of e.g. 3.3V to the pins *Top-Bottom* makes it possible to read out a voltage on pin *Left* or *Right* which is linear to the Y-coordinate of the pressed point. The X-coordinate will result when the voltage will be supplied to *Left-Right* and measurement is done at *Top* or *Bottom*. The pinout of the connecting cable is shown in the drawing.

Specification			
Specification	min	max	Unit
Top-Bottom	t.b.d.	t.b.d.	Ω
Left-Right	t.b.d.	t.b.d.	Ω
Voltage	3	12	V
Current	5	25	mA
Linearity		1,5	%
Force	45	65	g
Contact Bounce	5	10	ms
Op. Temperatur	-20	+60	°C
Stor. Temperatur	-20	+70	°C
Transmission	75	85	%
Life Time	100000		Cycles

ZIF CONNECTOR EA WF100-04S

As an accessory for the touch panel we do provide a ZIF connector (4 pins) with pitch 1.0mm (SMD type). This connector is a „bottom side contact“ type.

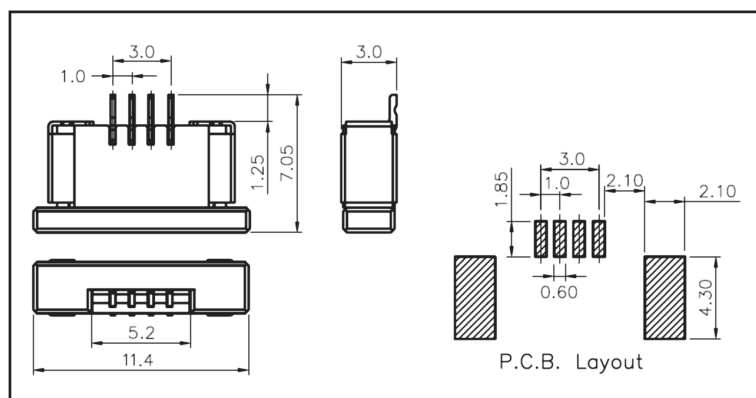

alle dimensions are in mm

DIMENSIONS EA DOGS102-6

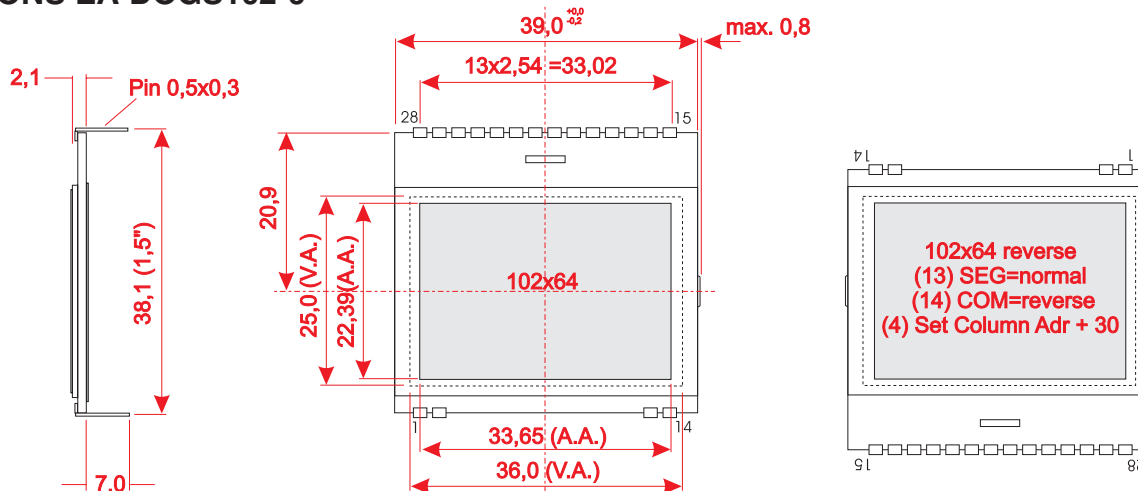

DIMENSIONS EA LED39X41

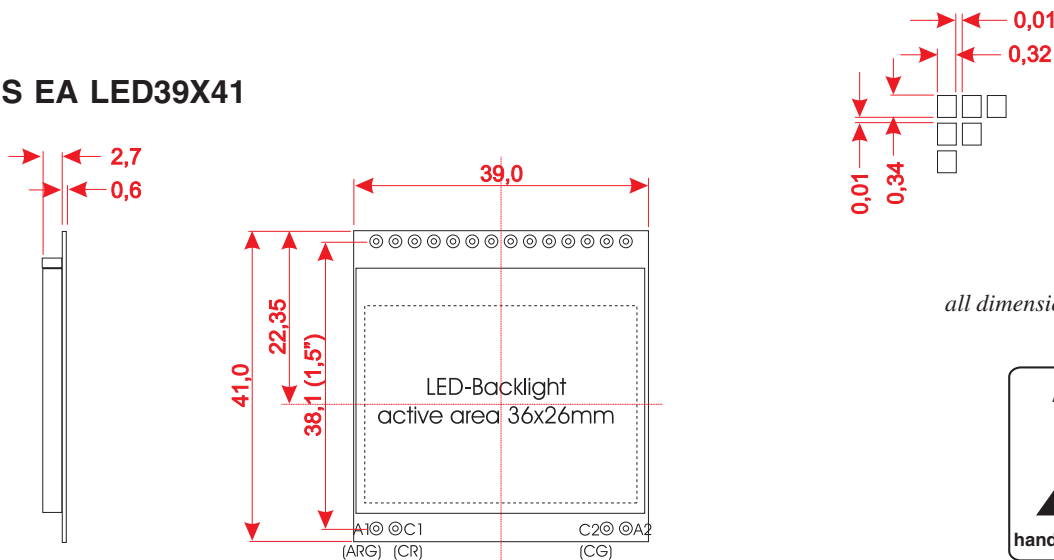

all dimensions are in mm



MOUNTING / ASSEMBLING

First, clip the display and backlight modules together by gently pushing the display pins through the corresponding holes on the backlight module. Then insert the entire module into the socket, or into the soldering holes on the pcb. The backlight pins (4 pins at the bottom) must be soldered on the top side as well to ensure good contact between the modules.

Important:

- The display and the backlight do have in summary 3 protective films. There are some on the top and the bottom of the display and also one on the backlight. These must be removed.
- LC displays are generally not suited for wave or reflow soldering. Temperatures of over 80°C can cause lasting damage.
- Make sure that either display nor backlight will never come into contact with any kind of liquid like Fluxer, Cleaner, Water.



Компания «ЭлектроПласт» предлагает заключение долгосрочных отношений при поставках импортных электронных компонентов на взаимовыгодных условиях!

Наши преимущества:

- Оперативные поставки широкого спектра электронных компонентов отечественного и импортного производства напрямую от производителей и с крупнейших мировых складов;
- Поставка более 17-ти миллионов наименований электронных компонентов;
- Поставка сложных, дефицитных, либо снятых с производства позиций;
- Оперативные сроки поставки под заказ (от 5 рабочих дней);
- Экспресс доставка в любую точку России;
- Техническая поддержка проекта, помощь в подборе аналогов, поставка прототипов;
- Система менеджмента качества сертифицирована по Международному стандарту ISO 9001;
- Лицензия ФСБ на осуществление работ с использованием сведений, составляющих государственную тайну;
- Поставка специализированных компонентов (Xilinx, Altera, Analog Devices, Intersil, Interpoint, Microsemi, Aeroflex, Peregrine, Syfer, Eurofarad, Texas Instrument, Miteq, Cobham, E2V, MA-COM, Hittite, Mini-Circuits, General Dynamics и др.);

Помимо этого, одним из направлений компании «ЭлектроПласт» является направление «Источники питания». Мы предлагаем Вам помощь Конструкторского отдела:

- Подбор оптимального решения, техническое обоснование при выборе компонента;
- Подбор аналогов;
- Консультации по применению компонента;
- Поставка образцов и прототипов;
- Техническая поддержка проекта;
- Защита от снятия компонента с производства.



Как с нами связаться

Телефон: 8 (812) 309 58 32 (многоканальный)

Факс: 8 (812) 320-02-42

Электронная почта: org@eplast1.ru

Адрес: 198099, г. Санкт-Петербург, ул. Калинина, дом 2, корпус 4, литера А.