

## Optocoupler, Phototriac Output, High dV/dt, Low Input Current

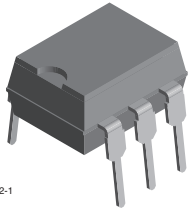

21842-1

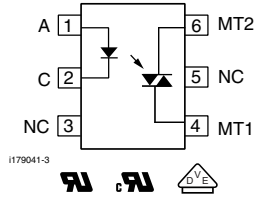

1179041-3



### FEATURES

- High input sensitivity  $I_{FT} = 1.3 \text{ mA}$
- 300 mA on-state current
- High static dV/dt 10000 V/ $\mu\text{s}$ , typical
- Very low leakage  $< 10 \mu\text{A}$
- Isolation test voltage 5300  $V_{RMS}$
- Compliant to RoHS Directive 2002/95/EC and in accordance to WEEE 2002/96/EC



**RoHS**  
COMPLIANT

### DESCRIPTION

The IL4216, IL4217, IL4218 consists of an AlGaAs IRLED optically coupled to a pair of photosensitive non-zero crossing SCR chips and are connected inversely parallel to form a TRIAC. These three semiconductors are assembled in a six pin 0.3 inch dual in-line package.

High input sensitivity is achieved by using an emitter follower phototransistor and a cascaded SCR predriver resulting in an LED trigger current of less than 1.3 mA (DC). The use of a proprietary dV/dt clamp results in a static dV/dt of greater than 10 kV/ $\mu\text{s}$ . This clamp circuit has a MOSFET that is enhanced when high dV/dt spikes occur between MT1 and MT2 of the TRIAC. The FET clamps the base of the phototransistor when conducting, disabling the internal SCR predriver.

The blocking voltage of up to 800 V permits control of off-line voltages up to 240  $V_{AC}$ , with a safety factor more than two, and is sufficient for as much as 380  $V_{AC}$ . Current handling capability is up to 300 mA RMS, continuous at 25 °C.

The IL4216, IL4217, IL4218 isolates low-voltage logic from 120, 240, and 380 VAC lines to control resistive inductive, or capacitive loads including motors solenoids, high current thyristors or TRIAC and relays.

### APPLICATIONS

- Solid state relay
- Industrial controls
- Office equipment
- Consumer appliances

### AGENCY APPROVALS

- UL1577, file no. E52744 system code J
- CSA 93751
- DIN EN 60747-5-5 (VDE 0884) available with option 1
- BSI IEC60950; IEC60065
- FIMKO

### ORDERING INFORMATION

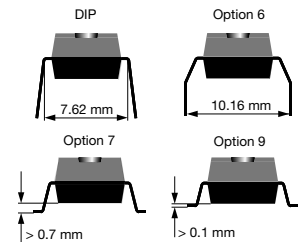
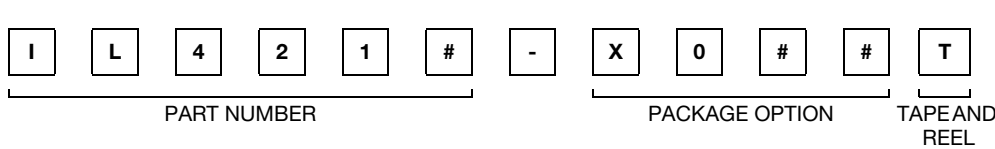

AGENCY CERTIFIED/PACKAGE	BLOCKING VOLTAGE $V_{DRM}$ (V)		
	600	700	800
<b>UL, cUL, BSI, FIMKO</b>			
DIP-6	IL4216	IL4217	IL4218
DIP-6, 400 mil, option 6	IL4216-X006	-	IL4218-X006
SMD-6, option 7	IL4216-X007T	IL4217-X007	-
SMD-6, option 9	IL4216-X009T <sup>(1)</sup>	IL4217-X009	-
<b>VDE, UL, cUL, BSI, FIMKO</b>			
DIP-6	IL4216-X001	-	IL4218-X001
DIP-6, 400 mil, option 6	IL4216-X016	-	IL4218-X016
SMD-6, option 7	-	-	IL4218-X017T <sup>(1)</sup>
SMD-6, option 9	-	-	IL4218-X019T <sup>(1)</sup>

**Note**

<sup>(1)</sup> Also available in tubes, do not put T on the end.

# IL4216, IL4217, IL4218



Vishay Semiconductors Optocoupler, Phototriac Output,  
High dV/dt, Low Input Current

ABSOLUTE MAXIMUM RATINGS <sup>(1)</sup> (T <sub>amb</sub> = 25 °C, unless otherwise specified)					
PARAMETER	TEST CONDITION	PART	SYMBOL	VALUE	UNIT
<b>INPUT</b>					
Reverse voltage			V <sub>R</sub>	6	V
Forward current			I <sub>F</sub>	60	mA
Surge current			I <sub>FSM</sub>	2.5	A
Power dissipation			P <sub>diss</sub>	100	mW
Derate linearly from 25 °C				1.33	mW/°C
Thermal resistance			R <sub>th</sub>	750	°C/W
<b>OUTPUT</b>					
Peak off-state voltage		IL4216	V <sub>DRM</sub>	600	V
		IL4217	V <sub>DRM</sub>	700	V
		IL4218	V <sub>DRM</sub>	800	V
RMS on-state current			I <sub>DRM</sub>	300	mA
Single cycle surge			I <sub>TSM</sub>	3	A
Power dissipation			P <sub>diss</sub>	300	mW
Derate linearly from 25 °C				6.6	mW/°C
Thermal resistance			R <sub>th</sub>	150	°C/W
<b>COUPLER</b>					
Creepage distance				≥ 7	mm
Clearance				≥ 7	mm
Storage temperature			T <sub>stg</sub>	- 55 to + 150	°C
Ambient temperature			T <sub>amb</sub>	- 55 to + 100	°C
Isolation test voltage			V <sub>ISO</sub>	5300	V <sub>RMS</sub>
Isolation resistance	V <sub>IO</sub> = 500 V, T <sub>amb</sub> = 25 °C		R <sub>IO</sub>	≥ 10 <sup>12</sup>	Ω
	V <sub>IO</sub> = 500 V, T <sub>amb</sub> = 100 °C		R <sub>IO</sub>	≥ 10 <sup>11</sup>	Ω
Lead soldering temperature <sup>(2)</sup>	5 s		T <sub>slid</sub>	260	°C

## Notes

- (1) Stresses in excess of the absolute maximum ratings can cause permanent damage to the device. Functional operation of the device is not implied at these or any other conditions in excess of those given in the operational sections of this document. Exposure to absolute maximum ratings for extended periods of the time can adversely affect reliability.
- (2) Refer to reflow profile for soldering conditions for surface mounted devices (SMD). Refer to wave profile for soldering conditions for through hole devices (DIP).



ELECTRICAL CHARACTERISTICS (T <sub>amb</sub> = 25 °C, unless otherwise specified)							
PARAMETER	TEST CONDITION	PART	SYMBOL	MIN.	TYP.	MAX.	UNIT
<b>INPUT</b>							
Forward voltage	I <sub>F</sub> = 20 mA		V <sub>F</sub>		1.3	1.5	V
Breakdown voltage	I <sub>R</sub> = 10 μA		V <sub>BR</sub>	6	30		V
Reverse current	V <sub>R</sub> = 6 V		I <sub>R</sub>		0.1	10	μA
Input capacitance	V <sub>F</sub> = 0 V, f = 1 MHz		C <sub>IN</sub>		40		pF
Thermal resistance, junction to lead			R <sub>thjl</sub>		750		°C/W
<b>OUTPUT</b>							
Repetitive peak off-state voltage	I <sub>DRM</sub> = 100 μA	IL4216	V <sub>DRM</sub>	600	650		V
		IL4217	V <sub>DRM</sub>	700	750		V
		IL4218	V <sub>DRM</sub>	800	850		V
Off-state voltage	I <sub>D(RMS)</sub> = 70 μA	IL4216	V <sub>D(RMS)</sub>	424	460		V
		IL4217	V <sub>D(RMS)</sub>	484	536		V
		IL4218	V <sub>D(RMS)</sub>	565	613		V
Off-state current	V <sub>D</sub> = 600 V, T <sub>amb</sub> = 100 °C		I <sub>D(RMS)</sub>		10	100	μA
Reverse current	V <sub>R</sub> = 600 V, T <sub>amb</sub> = 25 °C		I <sub>RMS</sub>		10	100	μA
On-state voltage	I <sub>T</sub> = 300 mA		V <sub>TM</sub>		1.7	3	V
On-state current	PF = 1, V <sub>T(RMS)</sub> = 1.7 V		I <sub>TM</sub>			300	mA
Surge (non-repetitive, on-state current)	f = 50 Hz		I <sub>TSM</sub>			3	A
Holding current	V <sub>T</sub> = 3 V		I <sub>H</sub>		65	200	μA
Latching current	V <sub>T</sub> = 2.2 V		I <sub>L</sub>			500	μA
LED trigger current	V <sub>AK</sub> = 5 V		I <sub>FT</sub>		0.7		mA
Critical rate of rise of off-state voltage	V <sub>D</sub> = 0.67 V <sub>DRM</sub> , T <sub>amb</sub> = 25 °C		dV/dt <sub>cr</sub>	10 000			V/μs
	V <sub>D</sub> = 0.67 V <sub>DRM</sub> , T <sub>amb</sub> = 80 °C		dV/dt <sub>cr</sub>	5000			V/μs
Critical rate of rise of voltage at current commutation	V <sub>D</sub> = 230 V <sub>RMS</sub> , I <sub>D</sub> = 300 mA <sub>RMS</sub> , T <sub>J</sub> = 25 °C		dV/dt <sub>crq</sub>		8		V/μs
	V <sub>D</sub> = 230 V <sub>RMS</sub> , I <sub>D</sub> = 300 mA <sub>RMS</sub> , T <sub>J</sub> = 85 °C		dV/dt <sub>crq</sub>		7		V/μs
Critical rate of rise of on-state current commutation	V <sub>D</sub> = 230 V <sub>RMS</sub> , I <sub>D</sub> = 300 mA <sub>RMS</sub> , T <sub>J</sub> = 25 °C		dI/dt <sub>crq</sub>		12		A/ms
Thermal resistance, junction to lead			R <sub>thjl</sub>		150		°C/W
<b>COUPLER</b>							
Capacitance (input to output)	f = 1 MHz, V <sub>IO</sub> = 0 V		C <sub>IO</sub>		0.8		pF
Critical rate of rise of coupled input to output voltage	I <sub>T</sub> = 0, V <sub>RM</sub> = V <sub>DM</sub> = 300 VAC		dV <sub>(IO)</sub> /dt	5000	1		mA

**Note**

- Minimum and maximum values are testing requirements. Typical values are characteristics of the device and are the result of engineering evaluation. Typical values are for information only and are not part of the testing requirements.

**POWER FACTOR CONSIDERATIONS**

A snubber is not needed to eliminate false operation of the TRIAC driver because of the IL4216, IL4217, IL4218 high static and commutating dV/dt with loads between 1 and 0.8 power factors. When inductive loads with power factors less than 0.8 are being driven, include a RC snubber or a single capacitor directly across the device to damp the peak commutating dV/dt spike. Normally a commutating dV/dt causes a turning-off device to stay on due to the stored energy remaining in the turning-off device.

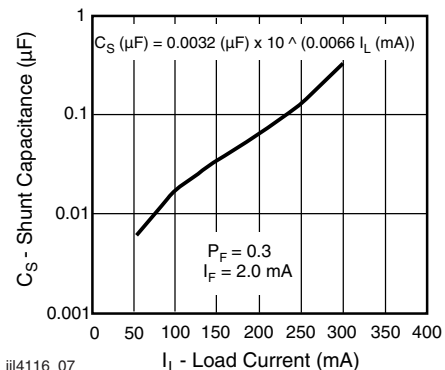

Fig. 1 - Shunt Capacitance vs. Load Current vs. Power Factor

# IL4216, IL4217, IL4218



Vishay Semiconductors Optocoupler, Phototriac Output,  
High dV/dt, Low Input Current

## TYPICAL CHARACTERISTICS ( $T_{amb} = 25\text{ }^{\circ}\text{C}$ , unless otherwise specified)

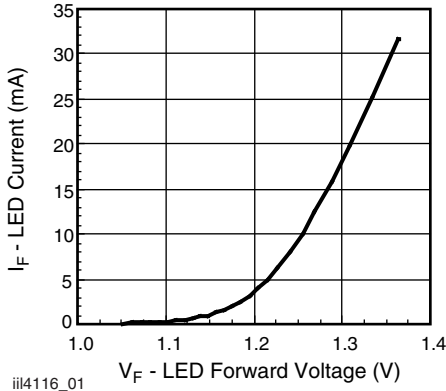

Fig. 2 - LED Forward Current vs. Forward Voltage

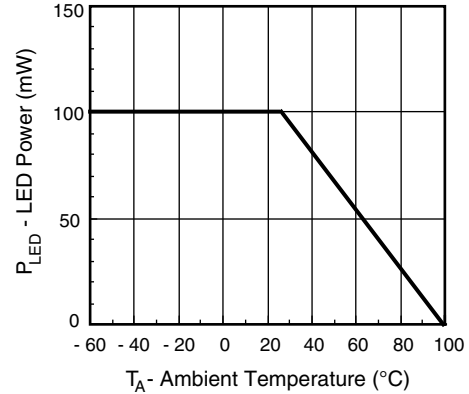

Fig. 5 - Maximum LED Power Dissipation

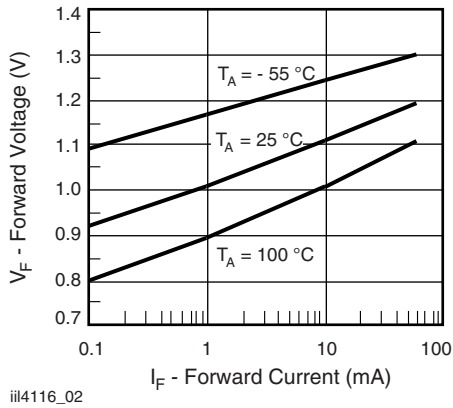

Fig. 3 - Forward Voltage vs. Forward Current

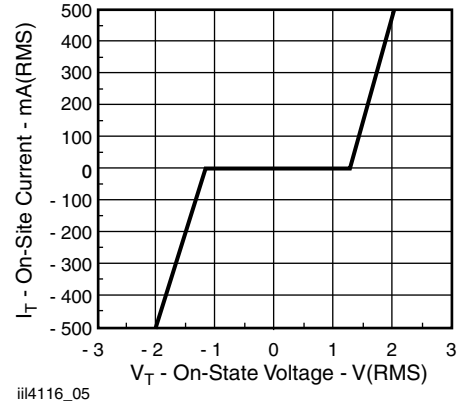

Fig. 6 - On-State Terminal Voltage vs. Terminal Current

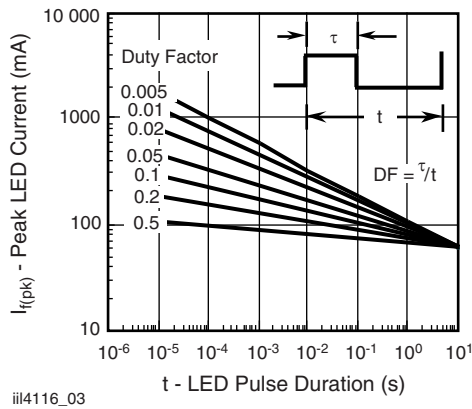

Fig. 4 - Peak LED Current vs. Duty Factor,  $\tau$

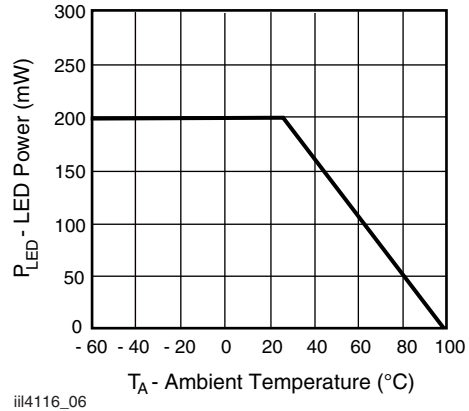

Fig. 7 - Maximum Output Power Dissipation



# IL4216, IL4217, IL4218

Optocoupler, Phototriac Output, Vishay Semiconductors  
High dV/dt, Low Input Current

## PACKAGE DIMENSIONS in millimeters

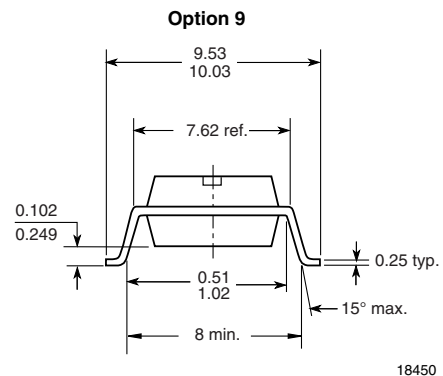
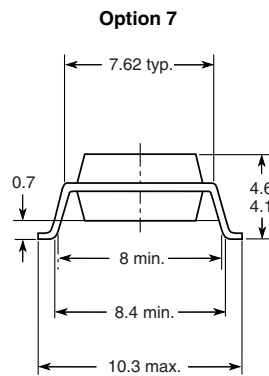
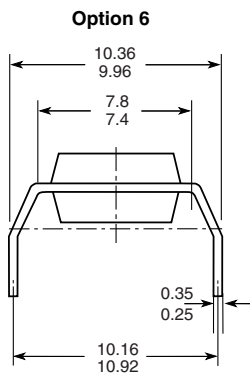
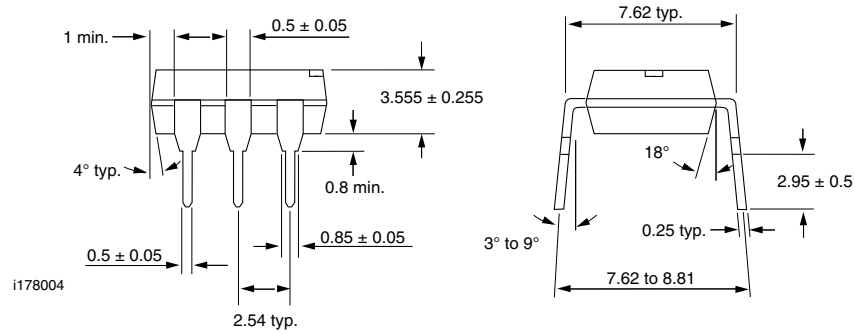
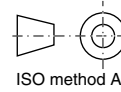
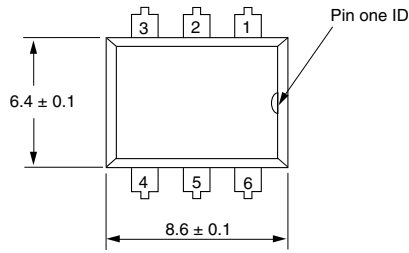



## Disclaimer

ALL PRODUCT, PRODUCT SPECIFICATIONS AND DATA ARE SUBJECT TO CHANGE WITHOUT NOTICE TO IMPROVE RELIABILITY, FUNCTION OR DESIGN OR OTHERWISE.

Vishay Intertechnology, Inc., its affiliates, agents, and employees, and all persons acting on its or their behalf (collectively, "Vishay"), disclaim any and all liability for any errors, inaccuracies or incompleteness contained in any datasheet or in any other disclosure relating to any product.

Vishay makes no warranty, representation or guarantee regarding the suitability of the products for any particular purpose or the continuing production of any product. To the maximum extent permitted by applicable law, Vishay disclaims (i) any and all liability arising out of the application or use of any product, (ii) any and all liability, including without limitation special, consequential or incidental damages, and (iii) any and all implied warranties, including warranties of fitness for particular purpose, non-infringement and merchantability.

Statements regarding the suitability of products for certain types of applications are based on Vishay's knowledge of typical requirements that are often placed on Vishay products in generic applications. Such statements are not binding statements about the suitability of products for a particular application. It is the customer's responsibility to validate that a particular product with the properties described in the product specification is suitable for use in a particular application. Parameters provided in datasheets and/or specifications may vary in different applications and performance may vary over time. All operating parameters, including typical parameters, must be validated for each customer application by the customer's technical experts. Product specifications do not expand or otherwise modify Vishay's terms and conditions of purchase, including but not limited to the warranty expressed therein.

Except as expressly indicated in writing, Vishay products are not designed for use in medical, life-saving, or life-sustaining applications or for any other application in which the failure of the Vishay product could result in personal injury or death. Customers using or selling Vishay products not expressly indicated for use in such applications do so at their own risk. Please contact authorized Vishay personnel to obtain written terms and conditions regarding products designed for such applications.

No license, express or implied, by estoppel or otherwise, to any intellectual property rights is granted by this document or by any conduct of Vishay. Product names and markings noted herein may be trademarks of their respective owners.

## Material Category Policy

**Vishay Intertechnology, Inc. hereby certifies that all its products that are identified as RoHS-Compliant fulfill the definitions and restrictions defined under Directive 2011/65/EU of The European Parliament and of the Council of June 8, 2011 on the restriction of the use of certain hazardous substances in electrical and electronic equipment (EEE) - recast, unless otherwise specified as non-compliant.**

**Please note that some Vishay documentation may still make reference to RoHS Directive 2002/95/EC. We confirm that all the products identified as being compliant to Directive 2002/95/EC conform to Directive 2011/65/EU.**

**Vishay Intertechnology, Inc. hereby certifies that all its products that are identified as Halogen-Free follow Halogen-Free requirements as per JEDEC JS709A standards. Please note that some Vishay documentation may still make reference to the IEC 61249-2-21 definition. We confirm that all the products identified as being compliant to IEC 61249-2-21 conform to JEDEC JS709A standards.**



Компания «ЭлектроПласт» предлагает заключение долгосрочных отношений при поставках импортных электронных компонентов на взаимовыгодных условиях!

Наши преимущества:

- Оперативные поставки широкого спектра электронных компонентов отечественного и импортного производства напрямую от производителей и с крупнейших мировых складов;
- Поставка более 17-ти миллионов наименований электронных компонентов;
- Поставка сложных, дефицитных, либо снятых с производства позиций;
- Оперативные сроки поставки под заказ (от 5 рабочих дней);
- Экспресс доставка в любую точку России;
- Техническая поддержка проекта, помощь в подборе аналогов, поставка прототипов;
- Система менеджмента качества сертифицирована по Международному стандарту ISO 9001;
- Лицензия ФСБ на осуществление работ с использованием сведений, составляющих государственную тайну;
- Поставка специализированных компонентов (Xilinx, Altera, Analog Devices, Intersil, Interpoint, Microsemi, Aeroflex, Peregrine, Syfer, Eurofarad, Texas Instrument, Miteq, Cobham, E2V, MA-COM, Hittite, Mini-Circuits, General Dynamics и др.);

Помимо этого, одним из направлений компании «ЭлектроПласт» является направление «Источники питания». Мы предлагаем Вам помощь Конструкторского отдела:

- Подбор оптимального решения, техническое обоснование при выборе компонента;
- Подбор аналогов;
- Консультации по применению компонента;
- Поставка образцов и прототипов;
- Техническая поддержка проекта;
- Защита от снятия компонента с производства.



#### Как с нами связаться

**Телефон:** 8 (812) 309 58 32 (многоканальный)

**Факс:** 8 (812) 320-02-42

**Электронная почта:** [org@eplast1.ru](mailto:org@eplast1.ru)

**Адрес:** 198099, г. Санкт-Петербург, ул. Калинина, дом 2, корпус 4, литера А.