

SPPC

SINGLE POLE POWER CONNECTORS

SPPC-PWL

Power Connectors, 400A / 750A

SPPC-HK

Compact Power Connectors, 250A / 400A

SPPC-LJP

Lug Joint Protector



Radiall 

 VanSystem

Introduction

SPPC-PWL – Single Pole Power Connectors



PWL Connectors have become widely adopted in a diverse range of applications and industries.

- Up to 750A, 1.000V
- IP67 when mated (according EN 60529)
- IP2x finger protected contacts
- Intermatable with any Powerlock and Powerline compliant connectors
- KSPC: keyed single pole connector, individual keyways to prevent connection errors

SPPC-HK – Compact Single Pole Power Connectors



HOOK Connectors have been developed as a PWL compact series.

- Up to 400A, 1.250V
- Reduced flange option
- IP67 when mated (according EN 60529)
- IP2x finger protected contacts
- Intermatable with any Vanten compliant connectors
- KSPC: keyed single pole connector, individual keyways to prevent connection errors

SPPC-LJP – Lug Joint Protector



LJP is a safe and efficient means to make temporary connection/extensions of single core power cables that are pre-terminated with copper lug terminals.

- Up to 780A, 1.000V
- IP67 when mated (according EN 60529)
- Accepts 120mm², 185mm², 240mm² and 30mm² lugs with holes size 12mm.
- Different lug sizes can be assembled in the same unit using the special accessories.

Characteristics

SPPC – Single Pole Power Connectors

Single Pole Power Connectors have become widely adopted in a diverse range of applications and industries.



APPLICATIONS

- Power distribution
- Utilities
- Electric Vehicles
- Railway Equipment
- Military Field Power
- Mobile Generators
- Loadbanks
- Back-up Power Systems

Key characteristics

- 500 Mating Cycles minimum.
- Intermateable with other versions.
- IP2X Finger Protected contacts.
- IP67 sealed when mated.
- Remote tool required to release the secondary locking of the mated connectors
- For use with Electrical Power Cables.
- Heavy Duty Hand Grips.
- Clip retained contacts.
- Cotter pin required for panel mount connectors.
- Cable sizes from 35mm² to 300mm²
- Facilitate cables up to 37mm Ø.
- High Impact Insulators.
- Harmonised Colour Coding.
- CE Compliant.
- EN/ESI compliant Creepage and Clearance distances.
- Multi-louver contact system.
- Mechanically keyed to prevent connection errors.
- Permanent Phase Marking
- Set Screw and Crimp contact versions.
- UL94 VO Flame Retardant.
- Field Assembly & Repair.
- Extraction tool required.
- Daisy Chain hook up system.



File N. E483437

Features and Benefits

- Connectors coding key to prevent possible wrong connections.
- mechanical key associated to harmonized colour system i.e. A Phase Line cannot be connected into Earth Line etc. i.e. in Europe Phase 1 is always brown
- secondary locking system

Introduction

SPPC – Single Pole Power Connectors

Power connectors types:

- **Source: female** connector is the source of the power, it receives and holds the male connector.
- **Drain: male** connectors receives and holds the female connector. The Drain connectors have a pin for the secondary locking (locks into the source connectors) The release key is required to unlock the secondary locking pin.
- **Inline: source (1) or drain (2)** is a moveable connectors fitted to a cable. The contacts are available in crimp or screw terminal.
- **Panel: source (3) or drain (4)** receptacle connectors to be fixed to a panel.

Power connectors cannot be mated/unmated under voltage or underloaded.

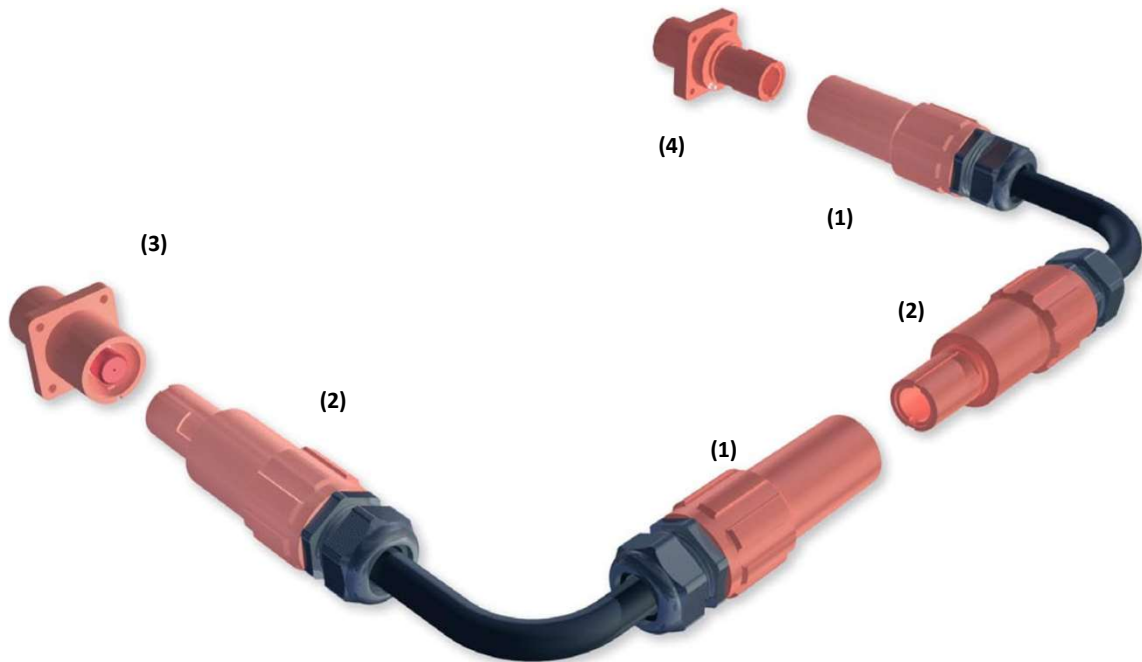

COLOR CODING

Standard	Phase L1	Phase L2	Phase L3	Earth	Neutral
Europe	Brown (BR) 	Black (BK) 	Grey (GY) 	Green (GN) 	Blue (BU) 
UK (*)	Red (RD) 	Yellow (YL) 	Blue (BU) 	Green (GN) 	Black (BK) 
USA (*)	Black (BK) 	Red (RD) 	Blue (BU) 	Green (GN) 	White (WH) 
Australia (*)	Red (RD) 	White (WH) 	Blue (BU) 	Green (GN) 	Black (BK) 
Direct current DC	-	Red (RD) 	-	Green (GN) 	Black (BK) 

* Color set on request

Characteristics

SPPC - PWL

Series	Connector Type	Key Position	Insulator Color	Contact Termination	Cable external diameter	Modification Number*
SPPC-PWL	LS	L1	BR	C-240	M	

<i>Cable/Line Source</i>	LS
<i>Cable/Line Drain</i>	LD
<i>Panel Source</i>	PS
<i>Panel Drain</i>	PD

<i>Earth</i>	E
<i>Neutral</i>	N
<i>Phase 1</i>	L1
<i>Phase 2</i>	L2
<i>Phase 3</i>	L3

<i>Brown</i>	BR	
<i>Black</i>	BK	
<i>Grey</i>	GY	
<i>Blue</i>	BU	
<i>Green</i>	GR	
<i>Red</i>	RD	
<i>Yellow</i>	YL	
<i>White</i>	WH	





<i>7mm – 15mm</i>	ES
<i>15mm – 23mm</i>	S
<i>19mm – 28mm</i>	M
<i>22mm – 32mm</i>	OS
<i>33mm - 37mm</i>	OS-M50

<i>M12 post – 750A up to 300mm²</i>	M12-T7
<i>M12 post – 400A up to 120mm²</i>	M12-T4
<i>Screw terminal – 400A up to 120mm²*</i>	S-120
<i>Crimp contacts – 750A 180mm²</i>	C-185
<i>Crimp contacts – 750A 240mm²</i>	C-240
<i>Crimp contacts – 750A 300mm²</i>	C-300
<i>Threaded hole – 750A up to 300mm²</i>	TH7
<i>Threaded hole – 400A up to 120mm²</i>	TH4

Product Range





PANEL DRAIN CONNECTORS - 750A
M12 post for conductor up to 300mm²



Color*	Designation	Order Number
Brown – Phase L1 	SPPC-PWL-PD-L1-BR-M12-T7	390110
Black – Phase L2 	SPPC-PWL-PD-L2-BK-M12-T7	390111
Grey – Phase L3 	SPPC-PWL-PD-L3-GY-M12-T7	390112
Blue – Neutral 	SPPC-PWL-PD-N-BU-M12-T7	390113
Green – Earth 	SPPC-PWL-PD-E-GN-M12-T7	390109





PANEL DRAIN CONNECTORS – 400A
M12 post for conductor up to 120mm²



Color*	Designation	Order Number
Brown – Phase L1 	SPPC-PWL-PD-L1-BR-M12-T4	390070
Black – Phase L2 	SPPC-PWL-PD-L2-BK-M12-T4	390071
Grey – Phase L3 	SPPC-PWL-PD-L3-GY-M12-T4	390072
Blue – Neutral 	SPPC-PWL-PD-N-BU-M12-T4	390068
Green – Earth 	SPPC-PWL-PD-E-GN-M12-T4	390263





PANEL DRAIN CONNECTORS - 750A
Threaded Hole



Color*	Designation	Order Number
Brown – Phase L1 	SPPC-PWL-PD-L1-BR-TH7	390280
Black – Phase L2 	SPPC-PWL-PD-L2-BK-TH7	390281
Grey – Phase L3 	SPPC-PWL-PD-L3-GY-TH7	390282
Blue – Neutral 	SPPC-PWL-PD-N-BU-TH7	390283
Green – Earth 	SPPC-PWL-PD-E-GN-TH7	390284

PANEL DRAIN CONNECTORS – 400A
Threaded Hole







Color*	Designation	Order Number
Brown – Phase L1 	SPPC-PWL-PD-L1-BR-TH4	390285
Black – Phase L2 	SPPC-PWL-PD-L2-BK-TH4	390286
Grey – Phase L3 	SPPC-PWL-PD-L3-GY-TH4	390287
Blue – Neutral 	SPPC-PWL-PD-N-BU-TH4	390288
Green – Earth 	SPPC-PWL-PD-E-GN-TH4	390289

Characteristics





PANEL SOURCE CONNECTORS - 750A M12 post for conductor up to 300mm²



Color*	Designation	Order Number
Brown – Phase L1 	SPPC-PWL-PS-L1-BR-M12-T7	390100
Black – Phase L2 	SPPC-PWL-PS-L2-BK-M12-T7	390101
Grey – Phase L3 	SPPC-PWL-PS-L3-GY-M12-T7	390102
Blue – Neutral 	SPPC-PWL-PS-N-BU-M12-T7	399000
Green – Earth 	SPPC-PWL-PS-E-GN-M12-T7	399004





PANEL SOURCE CONNECTORS – 400A M12 post for conductor up to 120mm²

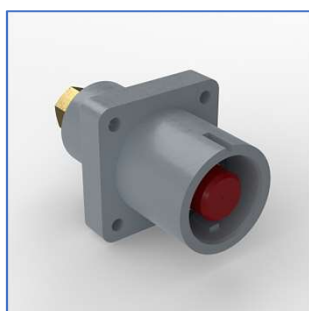

Color*	Designation	Order Number
Brown – Phase L1 	SPPC-PWL-PS-L1-BR-M12-T4	390065
Black – Phase L2 	SPPC-PWL-PS-L2-BK-M12-T4	390132
Grey – Phase L3 	SPPC-PWL-PS-L3-GY-M12-T4	390067
Blue – Neutral 	SPPC-PWL-PS-N-BU-M12-T4	390063
Green – Earth 	SPPC-PWL-PS-E-GN-M12-T4	390064





PANEL SOURCE CONNECTORS - 750A Threaded Hole







Color*	Designation	Order Number
Brown – Phase L1 	SPPC-PWL-PS-L1-BR-TH7	390290
Black – Phase L2 	SPPC-PWL-PS-L2-BK-TH7	390291
Grey – Phase L3 	SPPC-PWL-PS-L3-GY-TH7	390292
Blue – Neutral 	SPPC-PWL-PS-N-BU-TH7	390293
Green – Earth 	SPPC-PWL-PS-E-GN-TH7	390294

PANEL SOURCE CONNECTORS – 400A Threaded Hole







Color*	Designation	Order Number
Brown – Phase L1 	SPPC-PWL-PS-L1-BR-TH4	390295
Black – Phase L2 	SPPC-PWL-PS-L2-BK-TH4	390296
Grey – Phase L3 	SPPC-PWL-PS-L3-GY-TH4	390297
Blue – Neutral 	SPPC-PWL-PS-N-BU-TH4	390298
Green – Earth 	SPPC-PWL-PS-E-GN-TH4	390299

Product Range
CABLE/LINE DRAIN CONNECTORS - 400A
Screws terminal for conductor up to 120mm²

Color*	Designation	Order Number
Brown – Phase L1 	SPPC-PWL-LD-L1-BR-S-120-M	390091
Black – Phase L2 	SPPC-PWL-LD-L2-BK-S-120-M	390092
Grey – Phase L3 	SPPC-PWL-LD-L3-GY-S-120-M	390093
Blue – Neutral 	SPPC-PWL-LD-N-BU-S-120-M	390090
Green – Earth 	SPPC-PWL-LD-E-GN-S-120-M	390089





 Sleeves included, for cable conductor size 35 mm² - 50 mm² - 70 mm² - 95 mm² - 120 mm²
CABLE/LINE DRAIN CONNECTORS – 750A
Crimp contacts 300mm²

Color*	Designation	Order Number
Brown – Phase L1 	SPPC-PWL-LD-L1-BR-C-300-OS	390275
Black – Phase L2 	SPPC-PWL-LD-L2-BK-C-300-OS	390276
Grey – Phase L3 	SPPC-PWL-LD-L3-GY-C-300-OS	390277
Blue – Neutral 	SPPC-PWL-LD-N-BU-C-300-OS	390278
Green – Earth 	SPPC-PWL-LD-E-GN-C-300-OS	390279

CABLE/LINE DRAIN CONNECTORS – 750A
Crimp contacts 240mm²

Color*	Designation	Order Number
Brown – Phase L1 	SPPC-PWL-LD-L1-BR-C-240-OS	390105
Black – Phase L2 	SPPC-PWL-LD-L2-BK-C-240-OS	390106
Grey – Phase L3 	SPPC-PWL-LD-L3-GY-C-240-OS	390107
Blue – Neutral 	SPPC-PWL-LD-N-BU-C-240-OS	390274
Green – Earth 	SPPC-PWL-LD-E-GN-C-240-OS	390104

CABLE/LINE DRAIN CONNECTORS – 750A
Crimp contacts 185mm²







Color*	Designation	Order Number
Brown – Phase L1 	SPPC-PWL-LD-L1-BR-C-185-OS	390126
Black – Phase L2 	SPPC-PWL-LD-L2-BK-C-185-OS	390127
Grey – Phase L3 	SPPC-PWL-LD-L3-GY-C-185-OS	390128
Blue – Neutral 	SPPC-PWL-LD-N-BU-C-185-OS	390130
Green – Earth 	SPPC-PWL-LD-E-GN-C-185-OS	390129

Characteristics

CABLE/LINE SOURCE CONNECTORS - 400A

Screws terminal for conductor up to 120mm²







Color*	Designation	Order Number
Brown – Phase L1 	SPPC-PWL-LS-L1-BR-S-120-M	390086
Black – Phase L2 	SPPC-PWL-LS-L2-BK-S-120-M	390087
Grey – Phase L3 	SPPC-PWL-LS-L3-GY-S-120-M	390088
Blue – Neutral 	SPPC-PWL-LS-N-BU-S-120-M	390085
Green – Earth 	SPPC-PWL-LS-E-GN-S-120-M	390084

Sleeves included, for cable conductor size 35 mm² - 50 mm² - 70 mm² - 95 mm² - 120 mm²

CABLE/LINE SOURCE CONNECTORS – 750A

Crimp contacts 300mm²







Color*	Designation	Order Number
Brown – Phase L1 	SPPC-PWL-LS-L1-BR-C-300-OS	390197
Black – Phase L2 	SPPC-PWL-LS-L2-BK-C-300-OS	390198
Grey – Phase L3 	SPPC-PWL-LS-L3-GY-C-300-OS	390199
Blue – Neutral 	SPPC-PWL-LS-N-BU-C-300-OS	390300
Green – Earth 	SPPC-PWL-LS-E-GN-C-300-OS	390196

CABLE/LINE SOURCE CONNECTORS – 750A

Crimp contacts 240mm²







Color*	Designation	Order Number
Brown – Phase L1 	SPPC-PWL-LS-L1-BR-C-240-OS	390115
Black – Phase L2 	SPPC-PWL-LS-L2-BK-C-240-OS	390116
Grey – Phase L3 	SPPC-PWL-LS-L3-GY-C-240-OS	390117
Blue – Neutral 	SPPC-PWL-LS-N-BU-C-240-OS	390118
Green – Earth 	SPPC-PWL-LS-E-GN-C-240-OS	390114

CABLE/LINE SOURCE CONNECTORS – 750A

Crimp contacts 185mm²



Color*	Designation	Order Number
Brown – Phase L1 	SPPC-PWL-LS-L1-BR-C-185-OS	390235
Black – Phase L2 	SPPC-PWL-LS-L2-BK-C-185-OS	390154
Grey – Phase L3 	SPPC-PWL-LS-L3-GY-C-185-OS	390155
Blue – Neutral 	SPPC-PWL-LS-N-BU-C-185-OS	390225
Green – Earth 	SPPC-PWL-LS-E-GN-C-185-OS	390226

Product Range
REMOVAL TOOL

Type	Designation	Order Number
Screw set termination	SPPC-PWL-RT-25-120	390038
Crimp contacts	SPPC-PWL-RT-185-300	390039

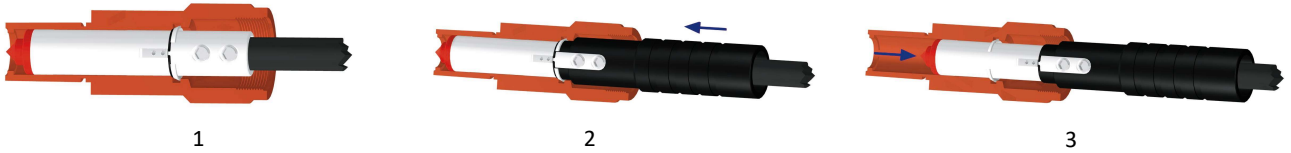
CRIMPING TOOL

Due to the numerous cable types available, it is recommended to contact us to confirm cable and crimp suitability.





Cable Size	Up to 120mm ²	185mm ² Class 2	240mm ² Class 2	300mm ² Class 2	185mm ² Class 5	240mm ² Class 5	300mm ² Class 5
Insulation Strip (dim C)	33mm	40mm	40mm	40mm	40mm	40mm	40mm
Recommended Number of Crimps	N/A (set screw)	2	3	3	2	3	3
Hand Operated Crimp Tool	N/A	HT131-C	HT131-C	HT131-C	HT131-C	HT131-C	HT131-C
Cordless Hydraulic Crimp Tool	N/A	B131-C	B131-C	B131-C	B131-C	B131-C	B131-C
Crimp Die Set	N/A	T185-C	T240-C	T300-C	T185-CF	T240-CF	T300-CF
Contact Removal Tool	390038	390039	390039	390039	390039	390039	390039

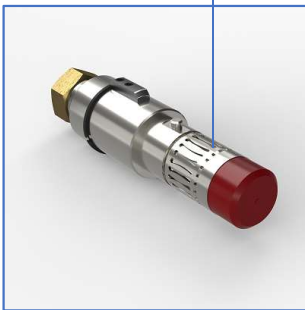
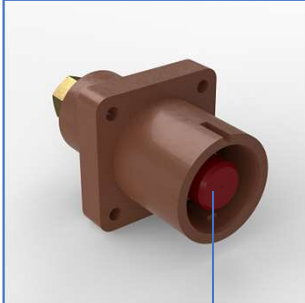

Characteristics

PANEL SOURCE CONNECTORS *(contacts and panel gasket to be order separately)*





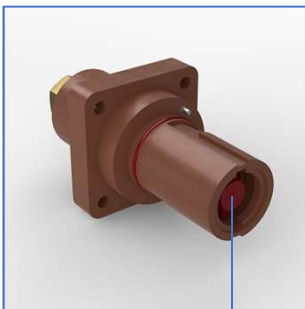

Color*	Designation	Order Number
Brown – Phase L1 	SPPC-PWL-PS-ISOL-L1-BR	392101
Black – Phase L2 	SPPC-PWL-PS-ISOL-L2-BK	392102
Grey – Phase L3 	SPPC-PWL-PS-ISOL-L3-GY	392103
Blue – Neutral 	SPPC-PWL-PS-ISOL-N-BU	392104
Green – Earth 	SPPC-PWL-PS-ISOL-E-GN	392105

Type	Designation	Order Number
Source - M12 post – 750A	SPPC-PWL-PS-CONT-M12-750A	392201
Source - M12 post – 400A	SPPC-PWL-PS-CONT-M12-400A	392203
Source – Threaded Hole – 750A	SPPC-PWL-PS-CONT-TH-750A	392205
Source - Threaded Hole – 400A	SPPC-PWL-PS-CONT-TH-400A	392207

PANEL DRAIN CONNECTORS *(contacts and panel gasket to be order separately)*





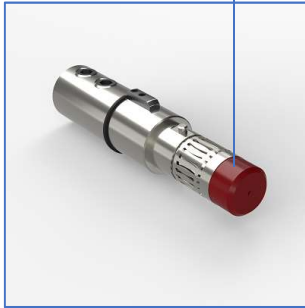

Color*	Designation	Order Number
Brown – Phase L1 	SPPC-PWL-PD-ISOL-L1-BR	392106
Black – Phase L2 	SPPC-PWL-PD-ISOL-L2-BK	392107
Grey – Phase L3 	SPPC-PWL-PD-ISOL-L3-GY	392108
Blue – Neutral 	SPPC-PWL-PD-ISOL-N-BU	392109
Green – Earth 	SPPC-PWL-PD-ISOL-E-GN	392110

Type	Designation	Order Number
Drain - M12 post – 750A	SPPC-PWL-PD-CONT-M12-750A	392202
Drain - M12 post – 400A	SPPC-PWL-PD-CONT-M12-400A	392204
Drain - Threaded Hole – 750A	SPPC-PWL-PD-CONT-TH-750A	392206
Drain - Threaded Hole – 400A	SPPC-PWL-PD-CONT-TH-400A	392208





*European Harmonized Color Set, others colors set on request

Product Range
INLINE SOURCE CONNECTORS *(contacts to be order separately)*

Color**	Designation	Order Number
Brown – Phase L1 	SPPC-PWL-LS-ISOL-L1-BR	392111
Black – Phase L2 	SPPC-PWL-LS-ISOL-L2-BK	392112
Grey – Phase L3 	SPPC-PWL-LS-ISOL-L3-GY	392113
Blue – Neutral 	SPPC-PWL-LS-ISOL-N-BU	392114
Green – Earth 	SPPC-PWL-LS-ISOL-E-GN	392115

Type	Designation	Order Number
Source – Screw up to 35mm ² -120mm ² *- 400A	SPPC-PWL-LS-CONT-S-400A	392209
Source – Crimp contacts 185 mm ² – 750A	SPPC-PWL-LS-CONT-CRIMP.185-750A	392211
Source – Crimp contacts 240 mm ² – 750A	SPPC-PWL-LS-CONT-CRIMP.240-750A	392213
Source – Crimp contacts 300 mm ² – 750A	SPPC-PWL-LS-CONT-CRIMP.300-750A	392215

INLINE DRAIN CONNECTORS *(contacts to be order separately)*

Color**	Designation	Order Number
Brown – Phase L1 	SPPC-PWL-LD-ISOL-L1-BR	392116
Black – Phase L2 	SPPC-PWL-LD-ISOL-L2-BK	392117
Grey – Phase L3 	SPPC-PWL-LD-ISOL-L3-GY	392118
Blue – Neutral 	SPPC-PWL-LD-ISOL-N-BU	392119
Green – Earth 	SPPC-PWL-LD-ISOL-E-GN	392120

Type	Designation	Order Number
Drain – Screw up to 35mm ² -120mm ² *- 400A	SPPC-PWL-LD-CONT-S-400A	392210
Drain – Crimp contacts 185 mm ² – 750A	SPPC-PWL-LD-CONT-CRIMP.185-750A	392212
Drain – Crimp contacts 240 mm ² – 750A	SPPC-PWL-LD-CONT-CRIMP.240-750A	392214
Drain – Crimp contacts 300 mm ² – 750A	SPPC-PWL-LD-CONT-CRIMP.300-750A	392216

* Sleeves included, for cable conductor size 35 mm² - 50 mm² - 70 mm² - 95 mm² - 120 mm²

Characteristics

BIMETALLIC CONNECTORS FOR ALUMINIUM CABLES







For crimping tool and crimping die, please consult our commercial office.

CABLE/LINE SOURCE CONNECTORS

Crimp contacts 300mm², cable external diameter 33mm – 37mm







Color*	Designation	Order Number
Brown – Phase L1 	SPPC-PWL-LS-L1-BR-C-300-OS-M50-BM	390437
Black – Phase L2 	SPPC-PWL-LS-L2-BK-C-300-OS-M50-BM	390438
Grey – Phase L3 	SPPC-PWL-LS-L3-GY-C-300-OS-M50-BM	390439
Blue – Neutral 	SPPC-PWL-LS-N-BU-C-300-OS-M50-BM	390436
Green – Earth 	SPPC-PWL-LS-E-GN-C-300-OS-M50-BM	390435

CABLE/LINE SOURCE CONNECTORS

Crimp contacts 240mm², cable external diameter 33mm – 37mm**







Color*	Designation	Order Number
Brown – Phase L1 	SPPC-PWL-LS-L1-BR-C-240-OS-M50-BM	390427
Black – Phase L2 	SPPC-PWL-LS-L2-BK-C-240-OS-M50-BM	390428
Grey – Phase L3 	SPPC-PWL-LS-L3-GY-C-240-OS-M50-BM	390429
Blue – Neutral 	SPPC-PWL-LS-N-BU-C-240-OS-M50-BM	390426
Green – Earth 	SPPC-PWL-LS-E-GN-C-240-OS-M50-BM	390425

** on request version OS-BM with cable external diameter 22mm – 32mm

CABLE/LINE SOURCE CONNECTORS

Crimp contacts 185mm², cable external diameter 22mm – 32mm



Color*	Designation	Order Number
Brown – Phase L1 	SPPC-PWL-LS-L1-BR-C-185-OS-BM	390407
Black – Phase L2 	SPPC-PWL-LS-L2-BK-C-185-OS-BM	390408
Grey – Phase L3 	SPPC-PWL-LS-L3-GY-C-185-OS-BM	390409
Blue – Neutral 	SPPC-PWL-LS-N-BU-C-185-OS-BM	390406
Green – Earth 	SPPC-PWL-LS-E-GN-C-185-OS-BM	390405

Product Range

BIMETALLIC CONNECTORS FOR ALUMINIUM CABLES







For crimping tool and crimping die, please consult our commercial office.

CABLE/LINE DRAIN CONNECTORS

Crimp contacts 300mm², cable external diameter 33mm – 37mm







Color*	Designation	Order Number
Brown – Phase L1 	SPPC-PWL-LD-L1-BR-C-300-OS-M50-BM	390432
Black – Phase L2 	SPPC-PWL-LD-L2-BK-C-300-OS-M50-BM	390433
Grey – Phase L3 	SPPC-PWL-LD-L3-GY-C-300-OS-M50-BM	390434
Blue – Neutral 	SPPC-PWL-LD-N-BU-C-300-OS-M50-BM	390431
Green – Earth 	SPPC-PWL-LD-E-GN-C-300-OS-M50-BM	390430

CABLE/LINE DRAIN CONNECTORS

Crimp contacts 240mm², cable external diameter 33mm – 37mm**







Color*	Designation	Order Number
Brown – Phase L1 	SPPC-PWL-LD-L1-BR-C-240-OS-M50-BM	390422
Black – Phase L2 	SPPC-PWL-LD-L2-BK-C-240-OS-M50-BM	390423
Grey – Phase L3 	SPPC-PWL-LD-L3-GY-C-240-OS-M50-BM	390424
Blue – Neutral 	SPPC-PWL-LD-N-BU-C-240-OS-M50-BM	390421
Green – Earth 	SPPC-PWL-LD-E-GN-C-240-OS-M50-BM	390420

** on request version OS-BM with cable external diameter 22mm – 32mm

CABLE/LINE DRAIN CONNECTORS

Crimp contacts 185mm², cable external diameter 22mm – 32mm



Color*	Designation	Order Number
Brown – Phase L1 	SPPC-PWL-LD-L1-BR-C-185-OS-BM	390402
Black – Phase L2 	SPPC-PWL-LD-L2-BK-C-185-OS-BM	390403
Grey – Phase L3 	SPPC-PWL-LD-L3-GY-C-185-OS-BM	390404
Blue – Neutral 	SPPC-PWL-LD-N-BU-C-185-OS-BM	390401
Green – Earth 	SPPC-PWL-LD-E-GN-C-185-OS -BM	390400

*European Harmonized Color Set, others colors set on request

Characteristics

CABLE GLAND FOR INLINE CONNECTORS



Type	Designation	Order Number
M40 threaded (19mm-28mm)	SPPC-PWL-M40	392301
M40 threaded (22mm-32mm)	SPPC-PWL-M40-A	392302
M50 threaded* (33mm-37mm)	SPPC-PWL-LS-M50	*

* To be ordered with inline connectors only

ENVIRONMENTAL LOCKING CAPS



Type	Designation	Order Number
Panel SOURCE	SPPC-PWL-PS-CAP	392304
Panel DRAIN	SPPC-PWL-PD-CAP	392305
Inline SOURCE	SPPC-PWL-LS-CAP	392306
Inline DRAIN	SPPC-PWL-LD-CAP	392307

Dust caps 392313 (SPPC-PWL-PS-LS DUST CAP source) and 392314 (SPPC-PWL-PD-LD DUST CAP drain) on request

PANEL GASKET

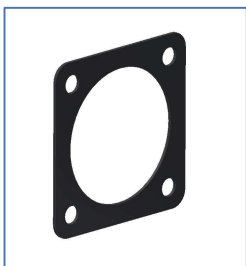

Type	Designation	Order Number
Neoprene Gaskets	SPPC-PWL-PG	392308

RELEASE KEY



Type	Designation	Order Number
Release Key	SPPC-PWL-KEY	392309

SLEEVE FOR SCREW CONTACTS

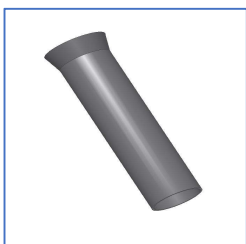

Type	Designation	Order Number
Sleeve**	SPPC-PWL-SLEEVE	392312

** Sleeves for cable conductor size 35 mm² - 50 mm² - 70 mm² - 95 mm² - 120 mm²

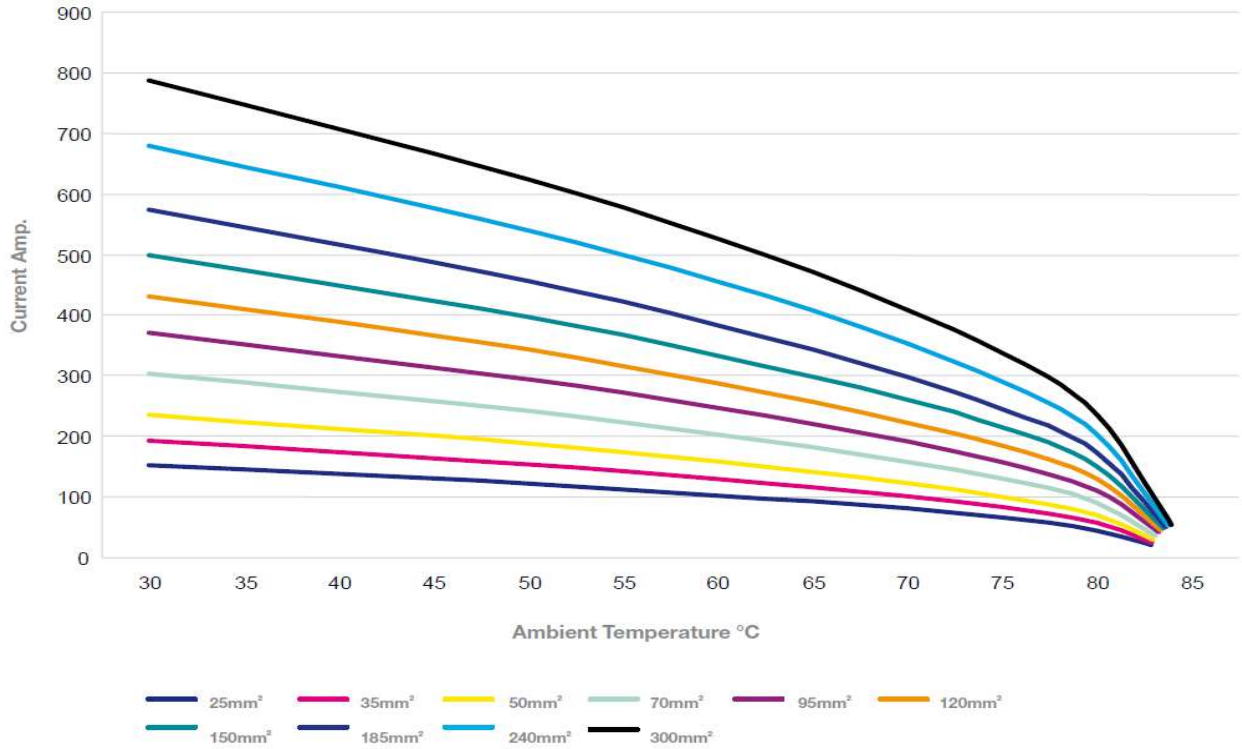
Derating data for 85°C rubber insulated cables.

CHARACTERISTICS

Screws Tightening Torque (in-line connectors)	12Nm
Panel Contact Tightening Torque	30Nm max
Cable Gland Tightening Torque	13Nm
Minimum Mating Cycles	500
Contact Retention in Insulator	2.5kN Axial Load
Flammability	UL94 V0
Environmental Sealing (when mated)	IP68
Rated Voltage to Earth	2000V AC
Minimum Flashover (EN60309-1)	6.8kV AC – 1 minute
Minimum Insulation Resistance	5Gohms @ 500v
Operating Voltage	1000V AC or DC
Test Voltage (Mated Condition)	5 kV– 1 minute @ 50Hz
Contact Resistance	<5mohms
Short Circuit Current – 1 second	16kA
Short Circuit Current – 3 seconds	12kA
Surge Current (DIN VDE 0102/1.90)	62kA – 10mseconds
Creepage Distance	>25mm
Clearance Distance	>25mm
Temperature Range	-30°C / +125°C

Characteristics

SPPC – Single Pole Power Connectors – up to 400A



HLock series offers new opportunities of using the electrical connection even in applications where in the past this was not possible due to low cost requirements and without renouncing to a complete range of features concerning robustness, reliability and safety.

APPLICATIONS

- Power distribution
- Utilities
- Electric Vehicles
- Railway Equipment
- Military Field Power
- Mobile Generators
- Loadbanks
- Back-up Power Systems

Key characteristics

- brass contacts for current up to 250A and cable section from 16 to 70sq.mm or from 4 to 2/0AWG
- copper contacts for current up to 400A and cable section from 95 to 120sq.mm or for 4/0AWG
- 500 mating cycles minimum
- IP67 sealed when mated
- EN/ESI compliant creepage and clearance distances
- UL 94V0 flame retardant insulating material
- EN/CE compliant metric cable glands
- Cable sizes from 16 to 120 sq.mm or from 4 to 4/0 AWG
- Set screw and crimp contact versions
- Multi-louver contact version
- CE compliant

Male cable connectors are typically used as the live or supply side of the circuit. They are finger protected in the un-mated condition to meet the requirements IP2X. They protect the user from accidental contact with any live elements.

Female cable connectors are typically used as the load side of the circuit.

The cable connectors are either available:

- With set screw termination (with or without crimping sleeves) for cable section from 16 to 70sq.mm or from 4 to 2/0AWG
- With crimp termination for cable sections up to 120sq.mm or for 4/0AWG

A plastic water tight strain relief is supplied to provide IP67 sealing.

Male panel connectors are typically used as the live or supply side of the circuit. They are finger protected in the un-mated condition to meet the requirements IP2X.

Female panel connectors are typically used as the load side of the circuit.

Panel connectors can be either front or rear mounted on equipment while maintaining EN/ESI creepage and clearance distances, and are supplied in brass material (up to 250A) or in copper material (up to 400A) versions.

These connectors have M12 threaded post termination and are supplied with pre-installed contacts.

Introduction

SPPC – Single Pole Power Connectors

Power connectors types:

- **Source: female** connector is the source of the power, it receives and holds the male connector.
- **Drain: male** connectors receives and holds the female connector. The Drain connectors have a pin for the secondary locking (locks into the source connectors) The release key is required to unlock the secondary locking pin.
- **Inline: source (1) or drain (2)** is a moveable connectors fitted to a cable. The contacts are available in crimp or screw terminal.
- **Panel: source (3) or drain (4)** receptacle connectors to be fixed to a panel.

Power connectors cannot be mated/unmated under voltage or underloaded.

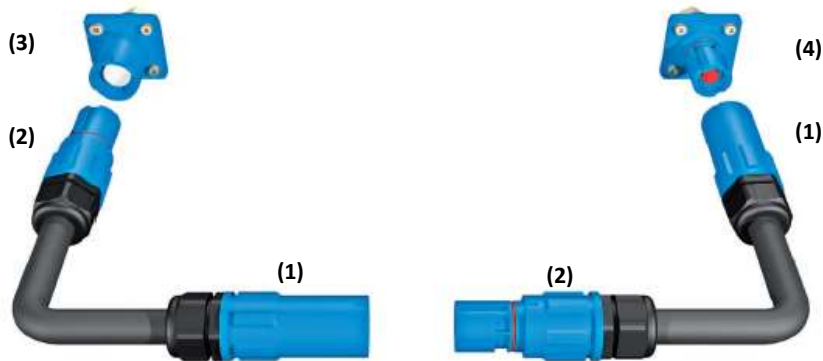

Mechanically keyed to prevent connection errors

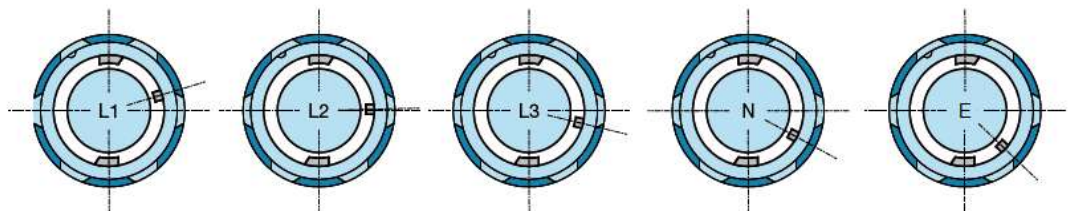

Harmonised colour coding.

* Other extra European or personalized colours available on request

Standard	Phase L1	Phase L2	Phase L3	Neutral	Earth
Europe	Brown (BR) 	Black (BK) 	Grey (GY) 	Blue (BU) 	Green (GN) 
UK (*)	Red (RD) 	Yellow (YL) 	Blue (BU) 	Black (BK) 	Green (GN) 
USA (*)	Black (BK) 	Red (RD) 	Blue (BU) 	White (WH) 	Green (GN) 
Australia (*)	Red (RD) 	White (WH) 	Blue (BU) 	Black (BK) 	Green (GN) 
Direct current DC	-	Red (RD) 	-	Black (BK) 	Green (GN) 

Characteristics

VANTEN mating system: a faster and more reliable connection

- Position major key alignment arrows
- Firmly push the male and female connectors together
- Rotate the male and female connectors in opposite direction until the padlock symbol is in alignment with the arrow symbol
- Release the connectors and they spring into the locked position.
- To unlock, push the connectors firmly together, rotate in opposite directions and pull apart

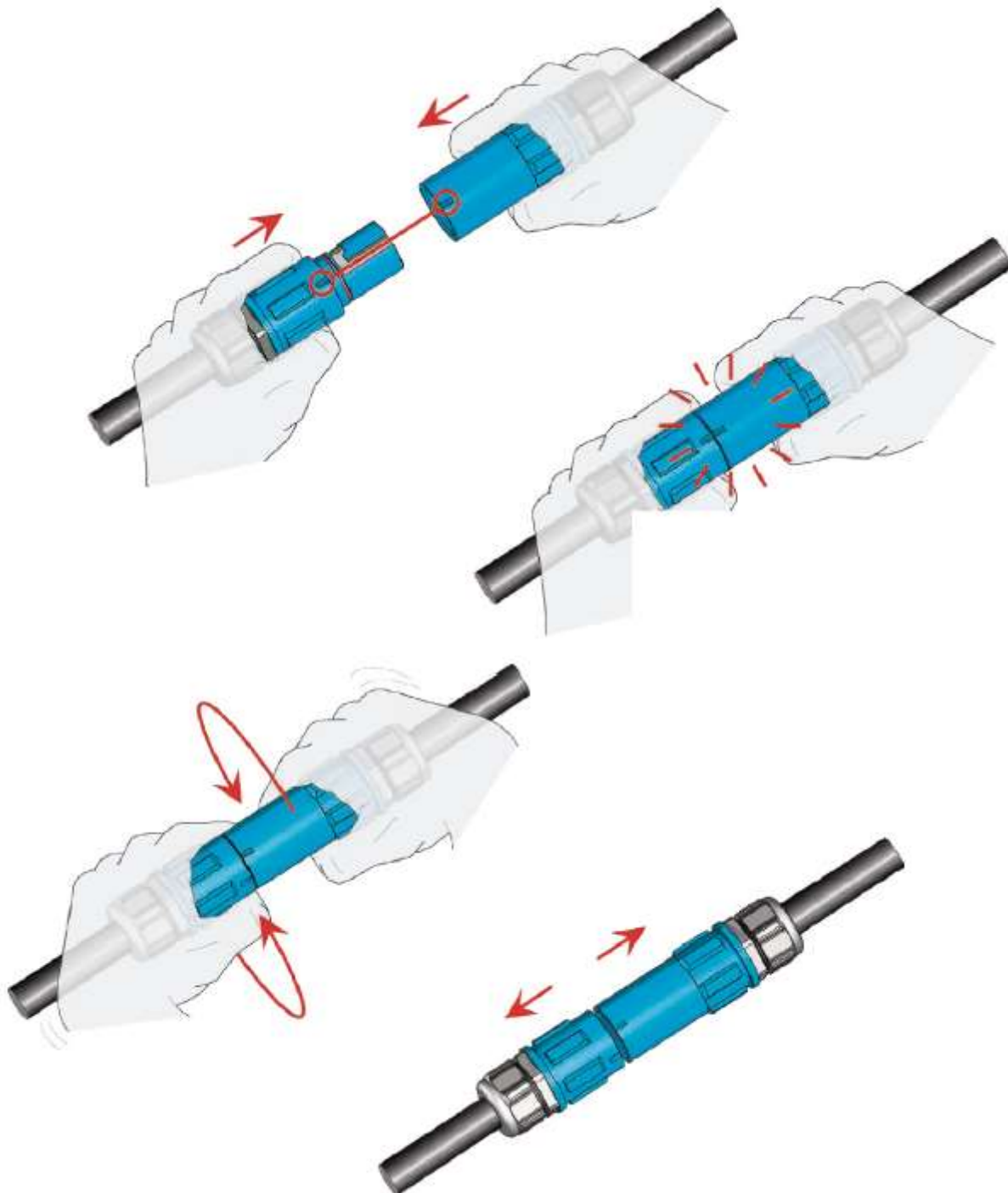

Introduction

SPPC – Single Pole Power Connectors

Unwanted uncoupling prevention: a simple trap makes the system safer.

The connectors can only be separated by removing it with a suitable tool.



Contact Removal

The contacts are inserted from the rear and snap into position within the insulator with no requirements for any cotter/dowel pin or assembly tool.

The contacts are removed from the insulator by using a simple tool to release the retaining clip.

- Improved mechanical insulator strength
- Reliable sealing
- Improved electrical integrity of the insulator
- Reduced assembly times
- The contacts can be removed and replaced

No replacement parts (cotter/dowel pins) are required.

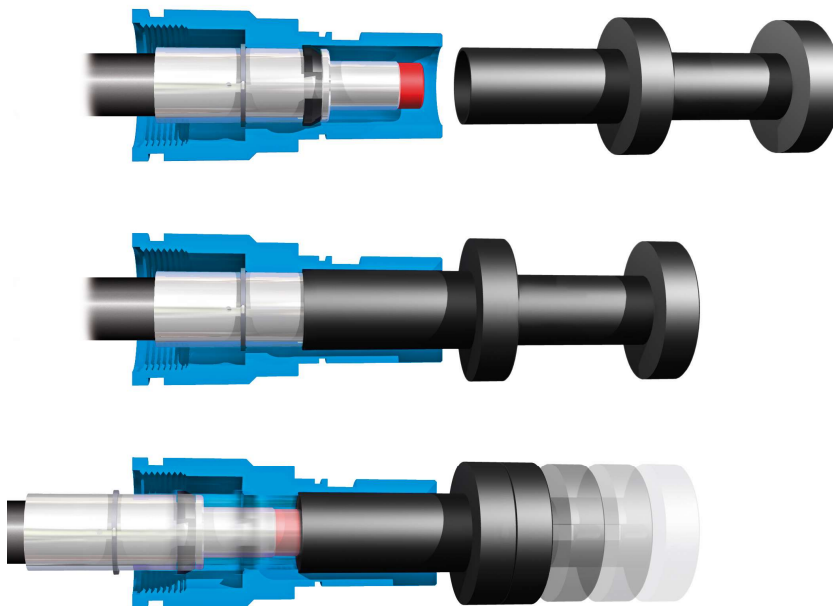

Characteristics

SPPC - HK

Series	Connector Type	Key Position	Insulator Color	Contact Termination	Cable external diameter	Modification Number*
SPPC-HK	LS	L1	BR	C-120	M	

<i>Cable/Line Source</i>	LS
<i>Cable/Line Drain</i>	LD
<i>Panel Source</i>	PS
<i>Panel Drain</i>	PD





<i>Earth</i>	E
<i>Neutral</i>	N
<i>Phase 1</i>	L1
<i>Phase 2</i>	L2
<i>Phase 3</i>	L3

<i>Brown</i>	BR	
<i>Black</i>	BK	
<i>Grey</i>	GY	
<i>Blue</i>	BU	
<i>Green</i>	GR	
<i>Red</i>	RD	
<i>Yellow</i>	YL	
<i>White</i>	WH	





<i>M12 post – 250A up to 70mm²</i>	M12-T2
<i>M12 post – 400A up to 120mm²</i>	M12-T4
<i>Screw terminal – 250A up to 70mm²*</i>	S-70
<i>Crimp contacts – 400A 95mm²- 120mm²</i>	C-120

<i>7mm – 15mm</i>	S
<i>11mm – 21mm</i>	M
<i>15mm – 25mm</i>	OS





Product Range
PANEL SOURCE CONNECTORS - 250A
M12 post for conductor up to 70mm²

Color*	Designation	Order Number
Brown – Phase L1 	SPPC-HK-PS-L1-BR-M12-T2	440004
Black – Phase L2 	SPPC-HK-PS-L2-BK-M12-T2	440017
Grey – Phase L3 	SPPC-HK-PS-L3-GY-M12-T2	440071
Blue – Neutral 	SPPC-HK-PS-N-BU-M12-T2	440072
Green – Earth 	SPPC-HK-PS-E-GN-M12-T2	440018





PANEL SOURCE CONNECTORS – 400A
M12 post for conductor up to 120mm²

Color*	Designation	Order Number
Brown – Phase L1 	SPPC-HK-PS-L1-BR-M12-T4	440033
Black – Phase L2 	SPPC-HK-PS-L2-BK-M12-T4	440034
Grey – Phase L3 	SPPC-HK-PS-L3-GY-M12-T4	440035
Blue – Neutral 	SPPC-HK-PS-N-BU-M12-T4	440032
Green – Earth 	SPPC-HK-PS-E-GN-M12-T4	440031

PANEL DRAIN CONNECTORS - 250A
M12 post for conductor up to 70mm²

Color*	Designation	Order Number
Brown – Phase L1 	SPPC-HK-PD-L1-BR-M12-T2	440024
Black – Phase L2 	SPPC-HK-PD-L2-BK-M12-T2	440025
Grey – Phase L3 	SPPC-HK-PD-L3-GY-M12-T2	440069
Blue – Neutral 	SPPC-HK-PD-N-BU-M12-T2	440070
Green – Earth 	SPPC-HK-PD-E-GN-M12-T2	440001

PANEL DRAIN CONNECTORS – 400A
M12 post for conductor up to 120mm²







Color*	Designation	Order Number
Brown – Phase L1 	SPPC-HK-PD-L1-BR-M12-T4	440011
Black – Phase L2 	SPPC-HK-PD-L2-BK-M12-T4	440065
Grey – Phase L3 	SPPC-HK-PD-L3-GY-M12-T4	440066
Blue – Neutral 	SPPC-HK-PD-N-BU-M12-T4	440068
Green – Earth 	SPPC-HK-PD-E-GN-M12-T4	440067

Characteristics

CABLE/LINE DRAIN CONNECTORS - 250A

Screws terminal for conductor up to 70mm²







Color*	Designation	Order Number
Brown – Phase L1 	SPPC-HK-LD-L1-BR-S-70-M	440002
Black – Phase L2 	SPPC-HK-LD-L2-BK-S-70-M	440054
Grey – Phase L3 	SPPC-HK-LD-L3-GY-S-70-M	440073
Blue – Neutral 	SPPC-HK-LD-N-BU-S-70-M	440074
Green – Earth 	SPPC-HK-LD-E-GN-S-70-M	440036

Sleeves included, for cable conductor size 16mm² - 25mm² - 35mm² - 50mm² - 70mm²

CABLE/LINE DRAIN CONNECTORS – 400A

Crimp contacts 95mm² - 120mm²







Color*	Designation	Order Number
Brown – Phase L1 	SPPC-HK-LD-L1-BR-C-120-OS	440028
Black – Phase L2 	SPPC-HK-LD-L2-BK-C-120-OS	440029
Grey – Phase L3 	SPPC-HK-LD-L3-GY-C-120-OS	440030
Blue – Neutral 	SPPC-HK-LD-N-BU-C-120-OS	440027
Green – Earth 	SPPC-HK-LD-E-GN-C-120-OS	440026

CABLE/LINE SOURCE CONNECTORS – 250A

Screws terminal for conductor up to 70mm²







Color*	Designation	Order Number
Brown – Phase L1 	SPPC-HK-LS-L1-BR-S-70-M	440075
Black – Phase L2 	SPPC-HK-LS-L2-BK-S-70-M	440055
Grey – Phase L3 	SPPC-HK-LS-L3-GY-S-70-M	440076
Blue – Neutral 	SPPC-HK-LS-N-BU-S-70-M	440077
Green – Earth 	SPPC-HK-LS-E-GN-S-70-M	440078

Sleeves included, for cable conductor size 16mm² - 25mm² - 35mm² - 50mm² - 70mm²

CABLE/LINE SOURCE CONNECTORS – 400A

Crimp contacts 95mm² - 120mm²



Color*	Designation	Order Number
Brown – Phase L1 	SPPC-HK-LS-L1-BR-C-120-OS	440056
Black – Phase L2 	SPPC-HK-LS-L2-BK-C-120-OS	440057
Grey – Phase L3 	SPPC-HK-LS-L3-GY-C-120-OS	440062
Blue – Neutral 	SPPC-HK-LS-N-BU-C-120-OS	440064
Green – Earth 	SPPC-HK-LS-E-GN-C-120-OS	440063

REMOVAL TOOL

Type	Designation	Order Number
<i>Crimp and Screw contacts</i>	SPPC-HK-RT	750070

CRIMPING TOOL

Due to the numerous cable types available, it is recommended to contact us to confirm cable and crimp suitability.

Cable Size	Up to 70mm ²	95mm ²	120mm ² AWG 4/0
Insulation Strip (dim C)	26mm	20mm	20mm
Recommended Number of Crimps	N/A (set screw)	2	2
Hand Operated Crimp Tool	N/A	HT120	HT120
Crimp Die Set	N/A	ME24-C	ME29-C
Contact Removal Tool	750070	750070	750070

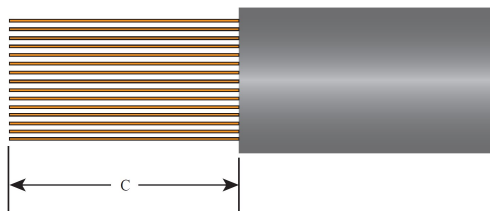

c

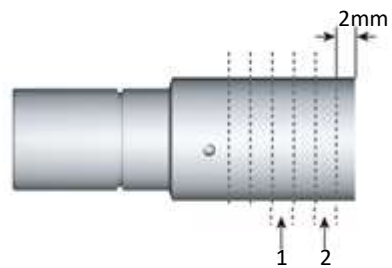

Characteristics

CABLE GLAND FOR INLINE CONNECTORS



Type	Designation	Order Number
M32 threaded 7mm – 15mm	SPPC-HK-M32-S	750061
M32 threaded 11mm-21mm	SPPC-HK-M32-M	750060
M32 threaded 15mm-25mm	SPPC-HK-M32-OS	*

* On request

PANEL GASKET

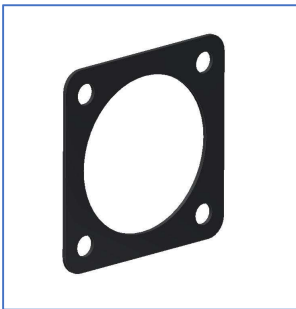

Type	Designation	Order Number
Neoprene Gaskets	SPPC-HK-PG	

SLEEVE FOR SCREW CONTACTS



Type	Designation	Order Number
Sleeve**	SPPC-HK-SLEEVE	750063

** Sleeves for cable conductor size 16mm² - 25mm² - 35mm² - 50mm² - 70mm²

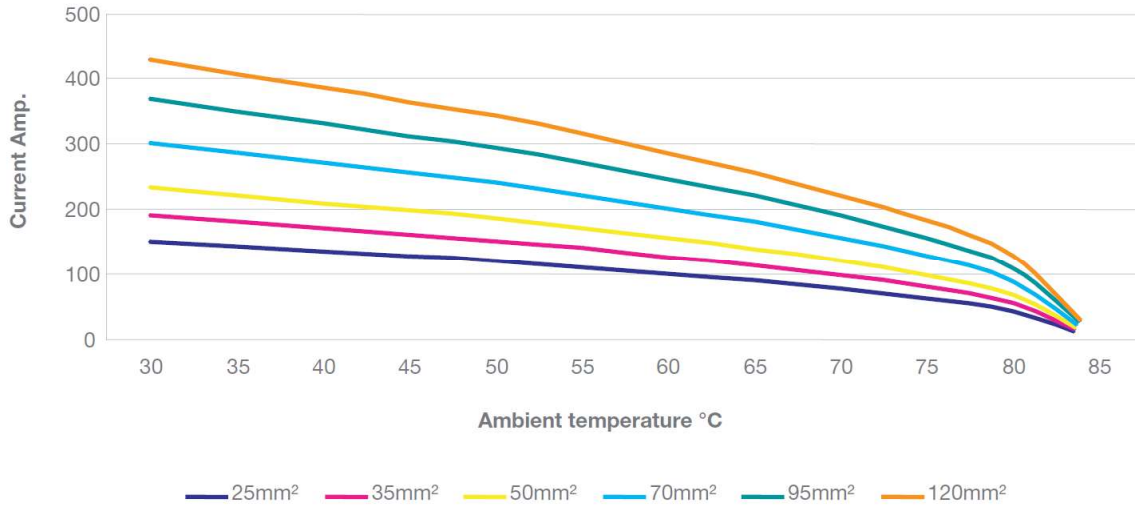
Derating data for 85°C rubber insulated cables.

CHARACTERISTICS

Insulation	1250V
Maximum panel thickness to guarantee insulation	6mm
Panel contact tightening torque	30Nm Max
Screws tightening torque (in-line connectors)	12Nm
Contact retention in Insulator	400N axial load
Inline contact retention	Plastic Clip
Panel mount contact retention	Dowel Pin
Contact release	Front
M32 Clamping range	7mm ÷ 25mm
Flammability	UL94 V0
Environmental sealing (when mated)	IP67
Connector protection (unmated)	IP2X
Rated voltage to Earth	1750VAC, panel thickness<4mm 1250VAC, panel thickness>4mm
Contact resistance	<0.1mOhms
Short circuit current	11KA -1 seconds
Short circuit current	4KA – 3 seconds
Surge current (din VDE 0102/1.90)	45KA – 10 mseconds
Temperature range	-30°C/+120°C

Characteristics

LUG-IT - Power cable joining system



Lugit is a safe and efficient means to make temporary connection / extensions of single core power cables that are pre-terminated with copper lug terminals.

APPLICATIONS

- Power distribution
- Utilities
- Electric Vehicles
- Railway Equipment
- Military Field Power
- Mobile Generators
- Loadbanks
- Back-up Power Systems

Key characteristics

- Increase cable utilization
- Reusable
- Suitable for temporary connections
- Standardize on cable lengths held in stock
- Decrease cable purchase
- Reduce transportation of cables between sites
- No need for connectors or junction boxes
- Daisy chain hook up system

Details

- IP67 Protected when assembled.
- Nominal Voltage Un: 1000Vac
- 2 Lug-it sizes available according to the lug and cable dimensions:
 - LJP-120 from 35mm² up to 120mm²
 - LJP-300 from 150mm² up to 300mm².
- Insulating voltage: 5.000Vac
- Rated current (to be checked with the specific cable characteristics):
 - Lugs 120 mm²:350A (30°C)
 - Lugs 185 mm²:570A (30°C)
 - Lugs 240 mm²:670A (30°C)
 - Lugs 300 mm²:780A (30°C)
- Working temperature: -30°C ÷ +120°C
- Protection degree: IP67 (EN 60529)
- Audible and tactile indication of locking
- Secure lock for unwanted / unauthorised release
- Quick assembly in approx. 2 minutes without special tools. The system can be disassembled and reused

Product Range

LUG-IT 300

Lock the central locking ring using the remote release key.



Lug Palm Width 45mm max, Bolt Hole 12mm,

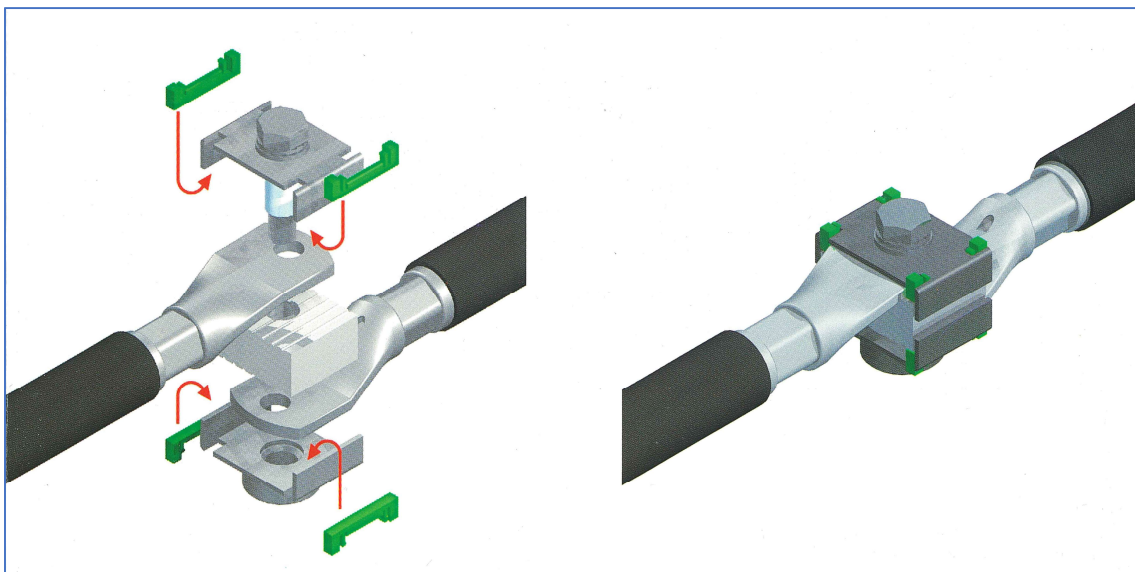

Characteristics

LUG-IT 120

Lock the central locking ring using the remote release key.

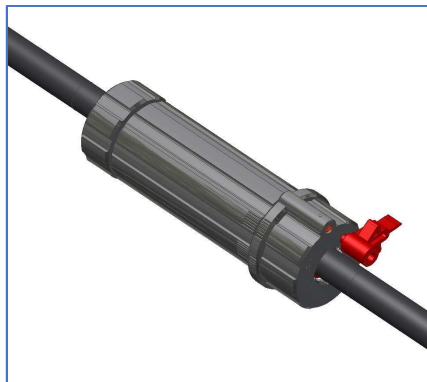
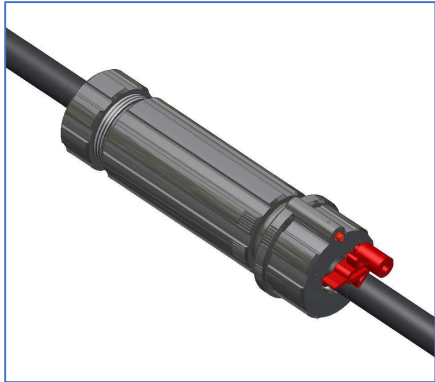

Lug Palm Width 30mm max, Bolt Hole 10mm or 12mm,

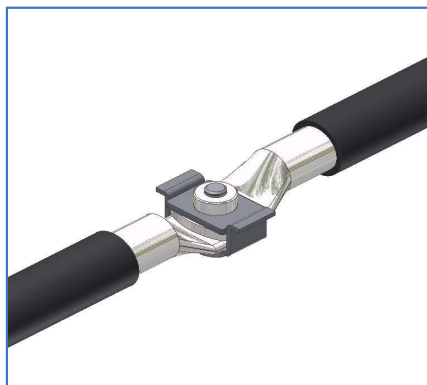
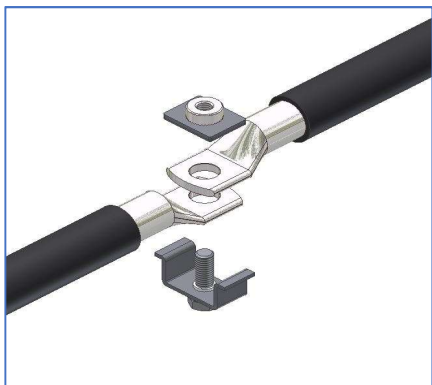

Product Range

LUG-IT 300

*Accepts cables 185mm², 240mm² and 300mm², for lugs with 12mm holes,
Lug Palm Width 45mm max, Bolt Hole 12mm,
External Cable Ø 20mm – 32mm.*



Designation	Order Number
SPPC-LJP-300	354801

LUG-IT 120

*Accepts cable 35mm² up to 120mm², for lugs with 8,2mm holes,
Lug Palm Width 30mm max, Bolt Hole 10mm or 12mm,
External Cable Ø 16mm – 23mm.*



Designation	Order Number
SPPC-LJP-120	354804

LUG-IT KEY

remote locking/release key



Designation	Order Number
SPPC-LJP-KEY	750082

SAFETY**Information regarding the use of the product within recommended safety limits**

To use the connectors described in this catalogue according to the necessary safety requirements we suggest you apply the following criteria:

- use the connectors and connected cables within their electrical and environmental limits
- follow the characteristics of each version (shell, class and type of strain relief) and carefully choose the appropriate connector for the required use
- make sure to respect the procedures regarding the correct assembly of connectors and the crimping of contacts
- any connector damaged during shipment, storage, assembly or use should be replaced
- never uncouple the connectors when under power
- always protect the parts against shock when the circuit is under power
- always check the circuit before putting it under power
- consult Radiall VanSystem Srl if in doubt
- the user must take final responsibility for electrical safety Radiall VanSystem Srl reserves the right to amend the specifications of this catalogue without issuing prior notice.

For the instructions concerning assembly and crimping of contacts please consult the appropriate tools manuals.

We recommend to respect the following general rules:

- to be used always the tools recommended by Radiall VanSystem's catalogue or manuals
- to be applied the suggested norms for tool maintenance and calibration

DO NOT USE ALTERNATIVE GREASES OR OILS which could damage the insert and affect the functionality of the connector.

Radiall VanSystem Srl reserves the right to amend the specifications of this catalogue without issuing prior notice.



www.radiall.com

FRANCE

RADIALL S.A.

Tel +33 1 49 35 35 35

info@radiall.com



www.vansystem.eu

ITALY

Radiall VanSystem S.r.l.

Tel. +39 02 3569931

info.vansystem@radiall.com



Компания «ЭлектроПласт» предлагает заключение долгосрочных отношений при поставках импортных электронных компонентов на взаимовыгодных условиях!

Наши преимущества:

- Оперативные поставки широкого спектра электронных компонентов отечественного и импортного производства напрямую от производителей и с крупнейших мировых складов;
- Поставка более 17-ти миллионов наименований электронных компонентов;
- Поставка сложных, дефицитных, либо снятых с производства позиций;
- Оперативные сроки поставки под заказ (от 5 рабочих дней);
- Экспресс доставка в любую точку России;
- Техническая поддержка проекта, помощь в подборе аналогов, поставка прототипов;
- Система менеджмента качества сертифицирована по Международному стандарту ISO 9001;
- Лицензия ФСБ на осуществление работ с использованием сведений, составляющих государственную тайну;
- Поставка специализированных компонентов (Xilinx, Altera, Analog Devices, Intersil, Interpoint, Microsemi, Aeroflex, Peregrine, Syfer, Eurofarad, Texas Instrument, Miteq, Cobham, E2V, MA-COM, Hittite, Mini-Circuits, General Dynamics и др.);

Помимо этого, одним из направлений компании «ЭлектроПласт» является направление «Источники питания». Мы предлагаем Вам помощь Конструкторского отдела:

- Подбор оптимального решения, техническое обоснование при выборе компонента;
- Подбор аналогов;
- Консультации по применению компонента;
- Поставка образцов и прототипов;
- Техническая поддержка проекта;
- Защита от снятия компонента с производства.



Как с нами связаться

Телефон: 8 (812) 309 58 32 (многоканальный)

Факс: 8 (812) 320-02-42

Электронная почта: org@eplast1.ru

Адрес: 198099, г. Санкт-Петербург, ул. Калинина, дом 2, корпус 4, литера А.