

SPPC

SINGLE POLE POWER CONNECTORS

SPPC-PWL

Power Connectors, 400A / 750A

SPPC-HK

Compact Power Connectors, 250A / 400A

SPPC-LJP

Lug Joint Protector



Radiall 

 VanSystem

Introduction

SPPC-PWL – Single Pole Power Connectors



PWL Connectors have become widely adopted in a diverse range of applications and industries.

- Up to 750A, 1.000V
- IP67 when mated (according EN 60529)
- IP2x finger protected contacts
- Intermatable with any Powerlock and Powerline compliant connectors
- KSPC: keyed single pole connector, individual keyways to prevent connection errors

SPPC-HK – Compact Single Pole Power Connectors



HOOK Connectors have been developed as a PWL compact series.

- Up to 400A, 1.250V
- Reduced flange option
- IP67 when mated (according EN 60529)
- IP2x finger protected contacts
- Intermatable with any Vanten compliant connectors
- KSPC: keyed single pole connector, individual keyways to prevent connection errors

SPPC-LJP – Lug Joint Protector



LJP is a safe and efficient means to make temporary connection/extensions of single core power cables that are pre-terminated with copper lug terminals.

- Up to 780A, 1.000V
- IP67 when mated (according EN 60529)
- Accepts 120mm², 185mm², 240mm² and 30mm² lugs with holes size 12mm.
- Different lug sizes can be assembled in the same unit using the special accessories.

Characteristics

SPPC – Single Pole Power Connectors

Single Pole Power Connectors have become widely adopted in a diverse range of applications and industries.



APPLICATIONS

- Power distribution
- Utilities
- Electric Vehicles
- Railway Equipment
- Military Field Power
- Mobile Generators
- Loadbanks
- Back-up Power Systems

Key characteristics

- 500 Mating Cycles minimum.
- Intermateable with other versions.
- IP2X Finger Protected contacts.
- IP67 sealed when mated.
- Remote tool required to release the secondary locking of the mated connectors
- For use with Electrical Power Cables.
- Heavy Duty Hand Grips.
- Clip retained contacts.
- Cotter pin required for panel mount connectors.
- Cable sizes from 35mm² to 300mm²
- Facilitate cables up to 37mm Ø.
- High Impact Insulators.
- Harmonised Colour Coding.
- CE Compliant.
- EN/ESI compliant Creepage and Clearance distances.
- Multi-louver contact system.
- Mechanically keyed to prevent connection errors.
- Permanent Phase Marking
- Set Screw and Crimp contact versions.
- UL94 VO Flame Retardant.
- Field Assembly & Repair.
- Extraction tool required.
- Daisy Chain hook up system.



File N. E483437

Features and Benefits

- Connectors coding key to prevent possible wrong connections.
- mechanical key associated to harmonized colour system i.e. A Phase Line cannot be connected into Earth Line etc. i.e. in Europe Phase 1 is always brown
- secondary locking system

Introduction

SPPC – Single Pole Power Connectors



Power connectors types:

- **Source:** female connector is the source of the power, it receives and holds the male connector.
- **Drain:** male connectors receives and holds the female connector. The Drain connectors have a pin for the secondary locking (locks into the source connectors) The release key is required to unlock the secondary locking pin.
- **Inline:** source (1) or drain (2) is a moveable connectors fitted to a cable. The contacts are available in crimp or screw terminal.
- **Panel:** source (3) or drain (4) receptacle connectors to be fixed to a panel.

Power connectors cannot be mated/unmated under voltage or underloaded.



COLOR CODING

| Standard | Phase L1 | Phase L2 | Phase L3 | Earth | Neutral |
|-------------------|------------------------------------------------------------------------------------------------|-------------------------------------------------------------------------------------------------|------------------------------------------------------------------------------------------------|--------------------------------------------------------------------------------------------------|--------------------------------------------------------------------------------------------------|
| Europe | Brown (BR)  | Black (BK)  | Grey (GY)  | Green (GN)  | Blue (BU)  |
| UK (*) | Red (RD)  | Yellow (YL)  | Blue (BU)  | Green (GN)  | Black (BK)  |
| USA (*) | Black (BK)  | Red (RD)  | Blue (BU)  | Green (GN)  | White (WH)  |
| Australia (*) | Red (RD)  | White (WH)  | Blue (BU)  | Green (GN)  | Black (BK)  |
| Direct current DC | - | Red (RD)  | - | Green (GN)  | Black (BK)  |

* Color set on request

Characteristics

SPPC - PWL

| Series | Connector Type | Key Position | Insulator Color | Contact Termination | Cable external diameter | Modification Number* |
|----------|----------------|--------------|-----------------|---------------------|-------------------------|----------------------|
| SPPC-PWL | LS | L1 | BR | C-240 | M | |

| | |
|--------------------------|----|
| <i>Cable/Line Source</i> | LS |
| <i>Cable/Line Drain</i> | LD |
| <i>Panel Source</i> | PS |
| <i>Panel Drain</i> | PD |

| | |
|----------------|----|
| <i>Earth</i> | E |
| <i>Neutral</i> | N |
| <i>Phase 1</i> | L1 |
| <i>Phase 2</i> | L2 |
| <i>Phase 3</i> | L3 |

| | | |
|---------------|----|-------------------------------------------------------------------------------------|
| <i>Brown</i> | BR |  |
| <i>Black</i> | BK |  |
| <i>Grey</i> | GY |  |
| <i>Blue</i> | BU |  |
| <i>Green</i> | GR |  |
| <i>Red</i> | RD |  |
| <i>Yellow</i> | YL |  |
| <i>White</i> | WH |  |

| | |
|--------------------|--------|
| <i>7mm – 15mm</i> | ES |
| <i>15mm – 23mm</i> | S |
| <i>19mm – 28mm</i> | M |
| <i>22mm – 32mm</i> | OS |
| <i>33mm - 37mm</i> | OS-M50 |

| | |
|-----------------------------------------------------------|--------|
| <i>M12 post – 750A up to 300mm²</i> | M12-T7 |
| <i>M12 post – 400A up to 120mm²</i> | M12-T4 |
| <i>Screw terminal – 400A up to 120mm²*</i> | S-120 |
| <i>Crimp contacts – 750A 180mm²</i> | C-185 |
| <i>Crimp contacts – 750A 240mm²</i> | C-240 |
| <i>Crimp contacts – 750A 300mm²</i> | C-300 |
| <i>Threaded hole – 750A up to 300mm²</i> | TH7 |
| <i>Threaded hole – 400A up to 120mm²</i> | TH4 |

Product Range

PANEL DRAIN CONNECTORS - 750A
M12 post for conductor up to 300mm²



| Color* | Designation | Order Number |
|----------------------------------------------------------------------------------------------------|--------------------------|--------------|
| Brown – Phase L1  | SPPC-PWL-PD-L1-BR-M12-T7 | 390110 |
| Black – Phase L2  | SPPC-PWL-PD-L2-BK-M12-T7 | 390111 |
| Grey – Phase L3  | SPPC-PWL-PD-L3-GY-M12-T7 | 390112 |
| Blue – Neutral  | SPPC-PWL-PD-N-BU-M12-T7 | 390113 |
| Green – Earth  | SPPC-PWL-PD-E-GN-M12-T7 | 390109 |





PANEL DRAIN CONNECTORS – 400A
M12 post for conductor up to 120mm²



| Color* | Designation | Order Number |
|-----------------------------------------------------------------------------------------------------|--------------------------|--------------|
| Brown – Phase L1  | SPPC-PWL-PD-L1-BR-M12-T4 | 390070 |
| Black – Phase L2  | SPPC-PWL-PD-L2-BK-M12-T4 | 390071 |
| Grey – Phase L3  | SPPC-PWL-PD-L3-GY-M12-T4 | 390072 |
| Blue – Neutral  | SPPC-PWL-PD-N-BU-M12-T4 | 390068 |
| Green – Earth  | SPPC-PWL-PD-E-GN-M12-T4 | 390263 |





PANEL DRAIN CONNECTORS - 750A
Threaded Hole



| Color* | Designation | Order Number |
|------------------------------------------------------------------------------------------------------|-----------------------|--------------|
| Brown – Phase L1  | SPPC-PWL-PD-L1-BR-TH7 | 390280 |
| Black – Phase L2  | SPPC-PWL-PD-L2-BK-TH7 | 390281 |
| Grey – Phase L3  | SPPC-PWL-PD-L3-GY-TH7 | 390282 |
| Blue – Neutral  | SPPC-PWL-PD-N-BU-TH7 | 390283 |
| Green – Earth  | SPPC-PWL-PD-E-GN-TH7 | 390284 |

PANEL DRAIN CONNECTORS – 400A
Threaded Hole







| Color* | Designation | Order Number |
|------------------------------------------------------------------------------------------------------|-----------------------|--------------|
| Brown – Phase L1  | SPPC-PWL-PD-L1-BR-TH4 | 390285 |
| Black – Phase L2  | SPPC-PWL-PD-L2-BK-TH4 | 390286 |
| Grey – Phase L3  | SPPC-PWL-PD-L3-GY-TH4 | 390287 |
| Blue – Neutral  | SPPC-PWL-PD-N-BU-TH4 | 390288 |
| Green – Earth  | SPPC-PWL-PD-E-GN-TH4 | 390289 |

Characteristics





PANEL SOURCE CONNECTORS - 750A M12 post for conductor up to 300mm²



| Color* | Designation | Order Number |
|----------------------------------------------------------------------------------------------------|--------------------------|--------------|
| Brown – Phase L1  | SPPC-PWL-PS-L1-BR-M12-T7 | 390100 |
| Black – Phase L2  | SPPC-PWL-PS-L2-BK-M12-T7 | 390101 |
| Grey – Phase L3  | SPPC-PWL-PS-L3-GY-M12-T7 | 390102 |
| Blue – Neutral  | SPPC-PWL-PS-N-BU-M12-T7 | 399000 |
| Green – Earth  | SPPC-PWL-PS-E-GN-M12-T7 | 399004 |





PANEL SOURCE CONNECTORS – 400A M12 post for conductor up to 120mm²

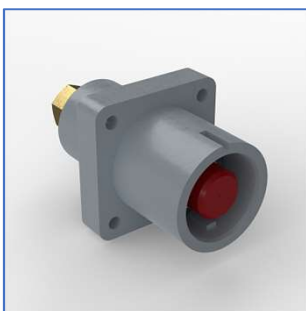

| Color* | Designation | Order Number |
|-----------------------------------------------------------------------------------------------------|--------------------------|--------------|
| Brown – Phase L1  | SPPC-PWL-PS-L1-BR-M12-T4 | 390065 |
| Black – Phase L2  | SPPC-PWL-PS-L2-BK-M12-T4 | 390132 |
| Grey – Phase L3  | SPPC-PWL-PS-L3-GY-M12-T4 | 390067 |
| Blue – Neutral  | SPPC-PWL-PS-N-BU-M12-T4 | 390063 |
| Green – Earth  | SPPC-PWL-PS-E-GN-M12-T4 | 390064 |





PANEL SOURCE CONNECTORS - 750A Threaded Hole



| Color* | Designation | Order Number |
|------------------------------------------------------------------------------------------------------|-----------------------|--------------|
| Brown – Phase L1  | SPPC-PWL-PS-L1-BR-TH7 | 390290 |
| Black – Phase L2  | SPPC-PWL-PS-L2-BK-TH7 | 390291 |
| Grey – Phase L3  | SPPC-PWL-PS-L3-GY-TH7 | 390292 |
| Blue – Neutral  | SPPC-PWL-PS-N-BU-TH7 | 390293 |
| Green – Earth  | SPPC-PWL-PS-E-GN-TH7 | 390294 |

PANEL SOURCE CONNECTORS – 400A Threaded Hole



| Color* | Designation | Order Number |
|------------------------------------------------------------------------------------------------------|-----------------------|--------------|
| Brown – Phase L1  | SPPC-PWL-PS-L1-BR-TH4 | 390295 |
| Black – Phase L2  | SPPC-PWL-PS-L2-BK-TH4 | 390296 |
| Grey – Phase L3  | SPPC-PWL-PS-L3-GY-TH4 | 390297 |
| Blue – Neutral  | SPPC-PWL-PS-N-BU-TH4 | 390298 |
| Green – Earth  | SPPC-PWL-PS-E-GN-TH4 | 390299 |

Product Range

CABLE/LINE DRAIN CONNECTORS - 400A

Screws terminal for conductor up to 120mm²







| Color* | Designation | Order Number |
|----------------------------------------------------------------------------------------------------|---------------------------|--------------|
| Brown – Phase L1  | SPPC-PWL-LD-L1-BR-S-120-M | 390091 |
| Black – Phase L2  | SPPC-PWL-LD-L2-BK-S-120-M | 390092 |
| Grey – Phase L3  | SPPC-PWL-LD-L3-GY-S-120-M | 390093 |
| Blue – Neutral  | SPPC-PWL-LD-N-BU-S-120-M | 390090 |
| Green – Earth  | SPPC-PWL-LD-E-GN-S-120-M | 390089 |

Sleeves included, for cable conductor size 35 mm² - 50 mm² - 70 mm² - 95 mm² - 120 mm²

CABLE/LINE DRAIN CONNECTORS – 750A

Crimp contacts 300mm²







| Color* | Designation | Order Number |
|-----------------------------------------------------------------------------------------------------|----------------------------|--------------|
| Brown – Phase L1  | SPPC-PWL-LD-L1-BR-C-300-OS | 390275 |
| Black – Phase L2  | SPPC-PWL-LD-L2-BK-C-300-OS | 390276 |
| Grey – Phase L3  | SPPC-PWL-LD-L3-GY-C-300-OS | 390277 |
| Blue – Neutral  | SPPC-PWL-LD-N-BU-C-300-OS | 390278 |
| Green – Earth  | SPPC-PWL-LD-E-GN-C-300-OS | 390279 |

CABLE/LINE DRAIN CONNECTORS – 750A

Crimp contacts 240mm²







| Color* | Designation | Order Number |
|------------------------------------------------------------------------------------------------------|----------------------------|--------------|
| Brown – Phase L1  | SPPC-PWL-LD-L1-BR-C-240-OS | 390105 |
| Black – Phase L2  | SPPC-PWL-LD-L2-BK-C-240-OS | 390106 |
| Grey – Phase L3  | SPPC-PWL-LD-L3-GY-C-240-OS | 390107 |
| Blue – Neutral  | SPPC-PWL-LD-N-BU-C-240-OS | 390274 |
| Green – Earth  | SPPC-PWL-LD-E-GN-C-240-OS | 390104 |

CABLE/LINE DRAIN CONNECTORS – 750A

Crimp contacts 185mm²







| Color* | Designation | Order Number |
|------------------------------------------------------------------------------------------------------|----------------------------|--------------|
| Brown – Phase L1  | SPPC-PWL-LD-L1-BR-C-185-OS | 390126 |
| Black – Phase L2  | SPPC-PWL-LD-L2-BK-C-185-OS | 390127 |
| Grey – Phase L3  | SPPC-PWL-LD-L3-GY-C-185-OS | 390128 |
| Blue – Neutral  | SPPC-PWL-LD-N-BU-C-185-OS | 390130 |
| Green – Earth  | SPPC-PWL-LD-E-GN-C-185-OS | 390129 |

Characteristics

CABLE/LINE SOURCE CONNECTORS - 400A

Screws terminal for conductor up to 120mm²







| Color* | Designation | Order Number |
|----------------------------------------------------------------------------------------------------|---------------------------|--------------|
| Brown – Phase L1  | SPPC-PWL-LS-L1-BR-S-120-M | 390086 |
| Black – Phase L2  | SPPC-PWL-LS-L2-BK-S-120-M | 390087 |
| Grey – Phase L3  | SPPC-PWL-LS-L3-GY-S-120-M | 390088 |
| Blue – Neutral  | SPPC-PWL-LS-N-BU-S-120-M | 390085 |
| Green – Earth  | SPPC-PWL-LS-E-GN-S-120-M | 390084 |

Sleeves included, for cable conductor size 35 mm² - 50 mm² - 70 mm² - 95 mm² - 120 mm²

CABLE/LINE SOURCE CONNECTORS – 750A

Crimp contacts 300mm²



| Color* | Designation | Order Number |
|-----------------------------------------------------------------------------------------------------|----------------------------|--------------|
| Brown – Phase L1  | SPPC-PWL-LS-L1-BR-C-300-OS | 390197 |
| Black – Phase L2  | SPPC-PWL-LS-L2-BK-C-300-OS | 390198 |
| Grey – Phase L3  | SPPC-PWL-LS-L3-GY-C-300-OS | 390199 |
| Blue – Neutral  | SPPC-PWL-LS-N-BU-C-300-OS | 390300 |
| Green – Earth  | SPPC-PWL-LS-E-GN-C-300-OS | 390196 |

CABLE/LINE SOURCE CONNECTORS – 750A

Crimp contacts 240mm²







| Color* | Designation | Order Number |
|------------------------------------------------------------------------------------------------------|----------------------------|--------------|
| Brown – Phase L1  | SPPC-PWL-LS-L1-BR-C-240-OS | 390115 |
| Black – Phase L2  | SPPC-PWL-LS-L2-BK-C-240-OS | 390116 |
| Grey – Phase L3  | SPPC-PWL-LS-L3-GY-C-240-OS | 390117 |
| Blue – Neutral  | SPPC-PWL-LS-N-BU-C-240-OS | 390118 |
| Green – Earth  | SPPC-PWL-LS-E-GN-C-240-OS | 390114 |

CABLE/LINE SOURCE CONNECTORS – 750A

Crimp contacts 185mm²



| Color* | Designation | Order Number |
|------------------------------------------------------------------------------------------------------|----------------------------|--------------|
| Brown – Phase L1  | SPPC-PWL-LS-L1-BR-C-185-OS | 390235 |
| Black – Phase L2  | SPPC-PWL-LS-L2-BK-C-185-OS | 390154 |
| Grey – Phase L3  | SPPC-PWL-LS-L3-GY-C-185-OS | 390155 |
| Blue – Neutral  | SPPC-PWL-LS-N-BU-C-185-OS | 390225 |
| Green – Earth  | SPPC-PWL-LS-E-GN-C-185-OS | 390226 |

Product Range
REMOVAL TOOL

| Type | Designation | Order Number |
|-----------------------|---------------------|--------------|
| Screw set termination | SPPC-PWL-RT-25-120 | 390038 |
| Crimp contacts | SPPC-PWL-RT-185-300 | 390039 |

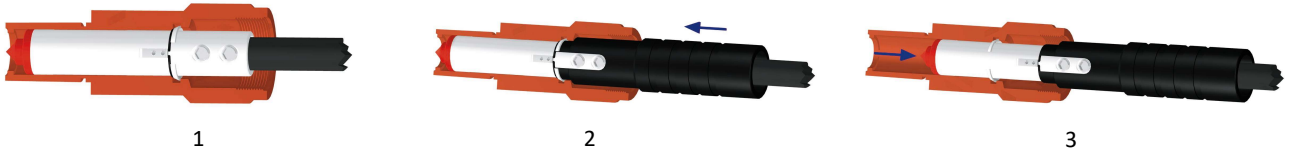
CRIMPING TOOL

Due to the numerous cable types available, it is recommended to contact us to confirm cable and crimp suitability.

| Cable Size | Up to 120mm ² | 185mm ² Class 2 | 240mm ² Class 2 | 300mm ² Class 2 | 185mm ² Class 5 | 240mm ² Class 5 | 300mm ² Class 5 |
|-------------------------------|--------------------------|----------------------------|----------------------------|----------------------------|----------------------------|----------------------------|----------------------------|
| Insulation Strip (dim C) | 33mm | 40mm | 40mm | 40mm | 40mm | 40mm | 40mm |
| Recommended Number of Crimps | N/A (set screw) | 2 | 3 | 3 | 2 | 3 | 3 |
| Hand Operated Crimp Tool | N/A | HT131-C | HT131-C | HT131-C | HT131-C | HT131-C | HT131-C |
| Cordless Hydraulic Crimp Tool | N/A | B131-C | B131-C | B131-C | B131-C | B131-C | B131-C |
| Crimp Die Set | N/A | T185-C | T240-C | T300-C | T185-CF | T240-CF | T300-CF |
| Contact Removal Tool | 390038 | 390039 | 390039 | 390039 | 390039 | 390039 | 390039 |



Characteristics

PANEL SOURCE CONNECTORS *(contacts and panel gasket to be order separately)*



| Color* | Designation | Order Number |
|----------------------------------------------------------------------------------------------------|------------------------|--------------|
| Brown – Phase L1  | SPPC-PWL-PS-ISOL-L1-BR | 392101 |
| Black – Phase L2  | SPPC-PWL-PS-ISOL-L2-BK | 392102 |
| Grey – Phase L3  | SPPC-PWL-PS-ISOL-L3-GY | 392103 |
| Blue – Neutral  | SPPC-PWL-PS-ISOL-N-BU | 392104 |
| Green – Earth  | SPPC-PWL-PS-ISOL-E-GN | 392105 |

| Type | Designation | Order Number |
|-------------------------------|---------------------------|--------------|
| Source - M12 post – 750A | SPPC-PWL-PS-CONT-M12-750A | 392201 |
| Source - M12 post – 400A | SPPC-PWL-PS-CONT-M12-400A | 392203 |
| Source – Threaded Hole – 750A | SPPC-PWL-PS-CONT-TH-750A | 392205 |
| Source - Threaded Hole – 400A | SPPC-PWL-PS-CONT-TH-400A | 392207 |

PANEL DRAIN CONNECTORS *(contacts and panel gasket to be order separately)*







| Color* | Designation | Order Number |
|------------------------------------------------------------------------------------------------------|------------------------|--------------|
| Brown – Phase L1  | SPPC-PWL-PD-ISOL-L1-BR | 392106 |
| Black – Phase L2  | SPPC-PWL-PD-ISOL-L2-BK | 392107 |
| Grey – Phase L3  | SPPC-PWL-PD-ISOL-L3-GY | 392108 |
| Blue – Neutral  | SPPC-PWL-PD-ISOL-N-BU | 392109 |
| Green – Earth  | SPPC-PWL-PD-ISOL-E-GN | 392110 |

| Type | Designation | Order Number |
|------------------------------|---------------------------|--------------|
| Drain - M12 post – 750A | SPPC-PWL-PD-CONT-M12-750A | 392202 |
| Drain - M12 post – 400A | SPPC-PWL-PD-CONT-M12-400A | 392204 |
| Drain - Threaded Hole – 750A | SPPC-PWL-PD-CONT-TH-750A | 392206 |
| Drain - Threaded Hole – 400A | SPPC-PWL-PD-CONT-TH-400A | 392208 |





*European Harmonized Color Set, others colors set on request

Product Range
INLINE SOURCE CONNECTORS *(contacts to be order separately)*

| Color** | Designation | Order Number |
|----------------------------------------------------------------------------------------------------|------------------------|--------------|
| Brown – Phase L1  | SPPC-PWL-LS-ISOL-L1-BR | 392111 |
| Black – Phase L2  | SPPC-PWL-LS-ISOL-L2-BK | 392112 |
| Grey – Phase L3  | SPPC-PWL-LS-ISOL-L3-GY | 392113 |
| Blue – Neutral  | SPPC-PWL-LS-ISOL-N-BU | 392114 |
| Green – Earth  | SPPC-PWL-LS-ISOL-E-GN | 392115 |

| Type | Designation | Order Number |
|--------------------------------------------------------------------|---------------------------------|--------------|
| Source – Screw up to 35mm ² -120mm ² *- 400A | SPPC-PWL-LS-CONT-S-400A | 392209 |
| Source – Crimp contacts 185 mm ² – 750A | SPPC-PWL-LS-CONT-CRIMP.185-750A | 392211 |
| Source – Crimp contacts 240 mm ² – 750A | SPPC-PWL-LS-CONT-CRIMP.240-750A | 392213 |
| Source – Crimp contacts 300 mm ² – 750A | SPPC-PWL-LS-CONT-CRIMP.300-750A | 392215 |

INLINE DRAIN CONNECTORS *(contacts to be order separately)*

| Color** | Designation | Order Number |
|------------------------------------------------------------------------------------------------------|------------------------|--------------|
| Brown – Phase L1  | SPPC-PWL-LD-ISOL-L1-BR | 392116 |
| Black – Phase L2  | SPPC-PWL-LD-ISOL-L2-BK | 392117 |
| Grey – Phase L3  | SPPC-PWL-LD-ISOL-L3-GY | 392118 |
| Blue – Neutral  | SPPC-PWL-LD-ISOL-N-BU | 392119 |
| Green – Earth  | SPPC-PWL-LD-ISOL-E-GN | 392120 |

| Type | Designation | Order Number |
|-------------------------------------------------------------------|---------------------------------|--------------|
| Drain – Screw up to 35mm ² -120mm ² *- 400A | SPPC-PWL-LD-CONT-S-400A | 392210 |
| Drain – Crimp contacts 185 mm ² – 750A | SPPC-PWL-LD-CONT-CRIMP.185-750A | 392212 |
| Drain – Crimp contacts 240 mm ² – 750A | SPPC-PWL-LD-CONT-CRIMP.240-750A | 392214 |
| Drain – Crimp contacts 300 mm ² – 750A | SPPC-PWL-LD-CONT-CRIMP.300-750A | 392216 |

* Sleeves included, for cable conductor size 35 mm² - 50 mm² - 70 mm² - 95 mm² - 120 mm²

Characteristics

BIMETALLIC CONNECTORS FOR ALUMINIUM CABLES



For crimping tool and crimping die, please consult our commercial office.

CABLE/LINE SOURCE CONNECTORS

Crimp contacts 300mm², cable external diameter 33mm – 37mm



| Color* | Designation | Order Number |
|-----------------------------------------------------------------------------------------------------|-----------------------------------|--------------|
| Brown – Phase L1  | SPPC-PWL-LS-L1-BR-C-300-OS-M50-BM | 390437 |
| Black – Phase L2  | SPPC-PWL-LS-L2-BK-C-300-OS-M50-BM | 390438 |
| Grey – Phase L3  | SPPC-PWL-LS-L3-GY-C-300-OS-M50-BM | 390439 |
| Blue – Neutral  | SPPC-PWL-LS-N-BU-C-300-OS-M50-BM | 390436 |
| Green – Earth  | SPPC-PWL-LS-E-GN-C-300-OS-M50-BM | 390435 |

CABLE/LINE SOURCE CONNECTORS

Crimp contacts 240mm², cable external diameter 33mm – 37mm**



| Color* | Designation | Order Number |
|------------------------------------------------------------------------------------------------------|-----------------------------------|--------------|
| Brown – Phase L1  | SPPC-PWL-LS-L1-BR-C-240-OS-M50-BM | 390427 |
| Black – Phase L2  | SPPC-PWL-LS-L2-BK-C-240-OS-M50-BM | 390428 |
| Grey – Phase L3  | SPPC-PWL-LS-L3-GY-C-240-OS-M50-BM | 390429 |
| Blue – Neutral  | SPPC-PWL-LS-N-BU-C-240-OS-M50-BM | 390426 |
| Green – Earth  | SPPC-PWL-LS-E-GN-C-240-OS-M50-BM | 390425 |

** on request version OS-BM with cable external diameter 22mm – 32mm

CABLE/LINE SOURCE CONNECTORS

Crimp contacts 185mm², cable external diameter 22mm – 32mm



| Color* | Designation | Order Number |
|------------------------------------------------------------------------------------------------------|-------------------------------|--------------|
| Brown – Phase L1  | SPPC-PWL-LS-L1-BR-C-185-OS-BM | 390407 |
| Black – Phase L2  | SPPC-PWL-LS-L2-BK-C-185-OS-BM | 390408 |
| Grey – Phase L3  | SPPC-PWL-LS-L3-GY-C-185-OS-BM | 390409 |
| Blue – Neutral  | SPPC-PWL-LS-N-BU-C-185-OS-BM | 390406 |
| Green – Earth  | SPPC-PWL-LS-E-GN-C-185-OS-BM | 390405 |





Product Range
BIMETALLIC CONNECTORS FOR ALUMINIUM CABLES

For crimping tool and crimping die, please consult our commercial office.

CABLE/LINE DRAIN CONNECTORS

Crimp contacts 300mm², cable external diameter 33mm – 37mm







| Color* | Designation | Order Number |
|-----------------------------------------------------------------------------------------------------|-----------------------------------|--------------|
| Brown – Phase L1  | SPPC-PWL-LD-L1-BR-C-300-OS-M50-BM | 390432 |
| Black – Phase L2  | SPPC-PWL-LD-L2-BK-C-300-OS-M50-BM | 390433 |
| Grey – Phase L3  | SPPC-PWL-LD-L3-GY-C-300-OS-M50-BM | 390434 |
| Blue – Neutral  | SPPC-PWL-LD-N-BU-C-300-OS-M50-BM | 390431 |
| Green – Earth  | SPPC-PWL-LD-E-GN-C-300-OS-M50-BM | 390430 |

CABLE/LINE DRAIN CONNECTORS

Crimp contacts 240mm², cable external diameter 33mm – 37mm**







| Color* | Designation | Order Number |
|------------------------------------------------------------------------------------------------------|-----------------------------------|--------------|
| Brown – Phase L1  | SPPC-PWL-LD-L1-BR-C-240-OS-M50-BM | 390422 |
| Black – Phase L2  | SPPC-PWL-LD-L2-BK-C-240-OS-M50-BM | 390423 |
| Grey – Phase L3  | SPPC-PWL-LD-L3-GY-C-240-OS-M50-BM | 390424 |
| Blue – Neutral  | SPPC-PWL-LD-N-BU-C-240-OS-M50-BM | 390421 |
| Green – Earth  | SPPC-PWL-LD-E-GN-C-240-OS-M50-BM | 390420 |

** on request version OS-BM with cable external diameter 22mm – 32mm

CABLE/LINE DRAIN CONNECTORS

Crimp contacts 185mm², cable external diameter 22mm – 32mm



| Color* | Designation | Order Number |
|------------------------------------------------------------------------------------------------------|-------------------------------|--------------|
| Brown – Phase L1  | SPPC-PWL-LD-L1-BR-C-185-OS-BM | 390402 |
| Black – Phase L2  | SPPC-PWL-LD-L2-BK-C-185-OS-BM | 390403 |
| Grey – Phase L3  | SPPC-PWL-LD-L3-GY-C-185-OS-BM | 390404 |
| Blue – Neutral  | SPPC-PWL-LD-N-BU-C-185-OS-BM | 390401 |
| Green – Earth  | SPPC-PWL-LD-E-GN-C-185-OS -BM | 390400 |

*European Harmonized Color Set, others colors set on request

Characteristics

CABLE GLAND FOR INLINE CONNECTORS



| Type | Designation | Order Number |
|------------------------------|-----------------|--------------|
| M40 threaded (19mm-28mm) | SPPC-PWL-M40 | 392301 |
| M40 threaded (22mm-32mm) | SPPC-PWL-M40-A | 392302 |
| M50 threaded* (33mm-37mm) | SPPC-PWL-LS-M50 | * |

* To be ordered with inline connectors only

ENVIRONMENTAL LOCKING CAPS



| Type | Designation | Order Number |
|---------------|-----------------|--------------|
| Panel SOURCE | SPPC-PWL-PS-CAP | 392304 |
| Panel DRAIN | SPPC-PWL-PD-CAP | 392305 |
| Inline SOURCE | SPPC-PWL-LS-CAP | 392306 |
| Inline DRAIN | SPPC-PWL-LD-CAP | 392307 |

Dust caps 392313 (SPPC-PWL-PS-LS DUST CAP source) and 392314 (SPPC-PWL-PD-LD DUST CAP drain) on request

PANEL GASKET

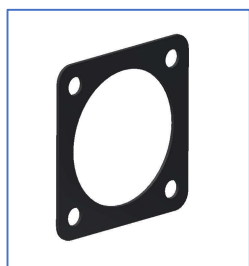

| Type | Designation | Order Number |
|------------------|-------------|--------------|
| Neoprene Gaskets | SPPC-PWL-PG | 392308 |

RELEASE KEY



| Type | Designation | Order Number |
|-------------|--------------|--------------|
| Release Key | SPPC-PWL-KEY | 392309 |

SLEEVE FOR SCREW CONTACTS

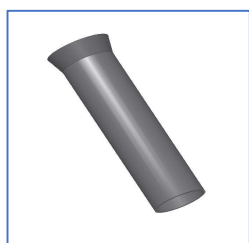

| Type | Designation | Order Number |
|----------|-----------------|--------------|
| Sleeve** | SPPC-PWL-SLEEVE | 392312 |

** Sleeves for cable conductor size 35 mm² - 50 mm² - 70 mm² - 95 mm² - 120 mm²

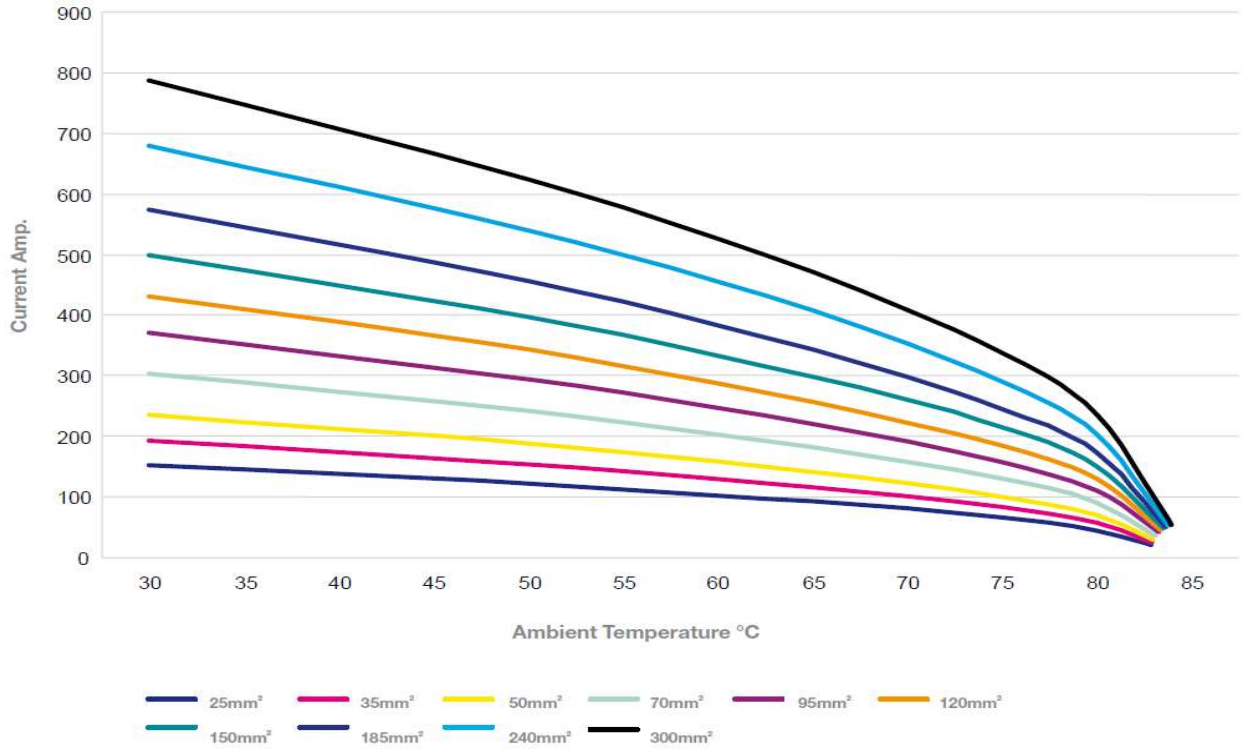
Derating data for 85°C rubber insulated cables.

CHARACTERISTICS

| | |
|-----------------------------------------------|-----------------------|
| Screws Tightening Torque (in-line connectors) | 12Nm |
| Panel Contact Tightening Torque | 30Nm max |
| Cable Gland Tightening Torque | 13Nm |
| Minimum Mating Cycles | 500 |
| Contact Retention in Insulator | 2.5kN Axial Load |
| Flammability | UL94 V0 |
| Environmental Sealing (when mated) | IP68 |
| Rated Voltage to Earth | 2000V AC |
| Minimum Flashover (EN60309-1) | 6.8kV AC – 1 minute |
| Minimum Insulation Resistance | 5Gohms @ 500v |
| Operating Voltage | 1000V AC or DC |
| Test Voltage (Mated Condition) | 5 kV– 1 minute @ 50Hz |
| Contact Resistance | <5mohms |
| Short Circuit Current – 1 second | 16kA |
| Short Circuit Current – 3 seconds | 12kA |
| Surge Current (DIN VDE 0102/1.90) | 62kA – 10mseconds |
| Creepage Distance | >25mm |
| Clearance Distance | >25mm |
| Temperature Range | -30°C / +125°C |

Characteristics

SPPC – Single Pole Power Connectors – up to 400A



HLock series offers new opportunities of using the electrical connection even in applications where in the past this was not possible due to low cost requirements and without renouncing to a complete range of features concerning robustness, reliability and safety.

APPLICATIONS

- Power distribution
- Utilities
- Electric Vehicles
- Railway Equipment
- Military Field Power
- Mobile Generators
- Loadbanks
- Back-up Power Systems

Key characteristics

- brass contacts for current up to 250A and cable section from 16 to 70sq.mm or from 4 to 2/0AWG
- copper contacts for current up to 400A and cable section from 95 to 120sq.mm or for 4/0AWG
- 500 mating cycles minimum
- IP67 sealed when mated
- EN/ESI compliant creepage and clearance distances
- UL 94V0 flame retardant insulating material
- EN/CE compliant metric cable glands
- Cable sizes from 16 to 120 sq.mm or from 4 to 4/0 AWG
- Set screw and crimp contact versions
- Multi-louver contact version
- CE compliant

Male cable connectors are typically used as the live or supply side of the circuit. They are finger protected in the un-mated condition to meet the requirements IP2X. They protect the user from accidental contact with any live elements.

Female cable connectors are typically used as the load side of the circuit.

The cable connectors are either available:

- With set screw termination (with or without crimping sleeves) for cable section from 16 to 70sq.mm or from 4 to 2/0AWG
- With crimp termination for cable sections up to 120sq.mm or for 4/0AWG

A plastic water tight strain relief is supplied to provide IP67 sealing.

Male panel connectors are typically used as the live or supply side of the circuit. They are finger protected in the un-mated condition to meet the requirements IP2X.

Female panel connectors are typically used as the load side of the circuit.

Panel connectors can be either front or rear mounted on equipment while maintaining EN/ESI creepage and clearance distances, and are supplied in brass material (up to 250A) or in copper material (up to 400A) versions.

These connectors have M12 threaded post termination and are supplied with pre-installed contacts.

Introduction

SPPC – Single Pole Power Connectors

Power connectors types:

- **Source: female** connector is the source of the power, it receives and holds the male connector.
- **Drain: male** connectors receives and holds the female connector. The Drain connectors have a pin for the secondary locking (locks into the source connectors) The release key is required to unlock the secondary locking pin.
- **Inline: source (1) or drain (2)** is a moveable connectors fitted to a cable. The contacts are available in crimp or screw terminal.
- **Panel: source (3) or drain (4)** receptacle connectors to be fixed to a panel.

Power connectors cannot be mated/unmated under voltage or underloaded.



Mechanically keyed to prevent connection errors



Harmonised colour coding.

* Other extra European or personalized colours available on request

| Standard | Phase L1 | Phase L2 | Phase L3 | Neutral | Earth |
|-------------------|------------------------------------------------------------------------------------------------|-------------------------------------------------------------------------------------------------|------------------------------------------------------------------------------------------------|--------------------------------------------------------------------------------------------------|--------------------------------------------------------------------------------------------------|
| Europe | Brown (BR)  | Black (BK)  | Grey (GY)  | Blue (BU)  | Green (GN)  |
| UK (*) | Red (RD)  | Yellow (YL)  | Blue (BU)  | Black (BK)  | Green (GN)  |
| USA (*) | Black (BK)  | Red (RD)  | Blue (BU)  | White (WH)  | Green (GN)  |
| Australia (*) | Red (RD)  | White (WH)  | Blue (BU)  | Black (BK)  | Green (GN)  |
| Direct current DC | - | Red (RD)  | - | Black (BK)  | Green (GN)  |

Characteristics

VANTEN mating system: a faster and more reliable connection

- Position major key alignment arrows
- Firmly push the male and female connectors together
- Rotate the male and female connectors in opposite direction until the padlock symbol is in alignment with the arrow symbol
- Release the connectors and they spring into the locked position.
- To unlock, push the connectors firmly together, rotate in opposite directions and pull apart

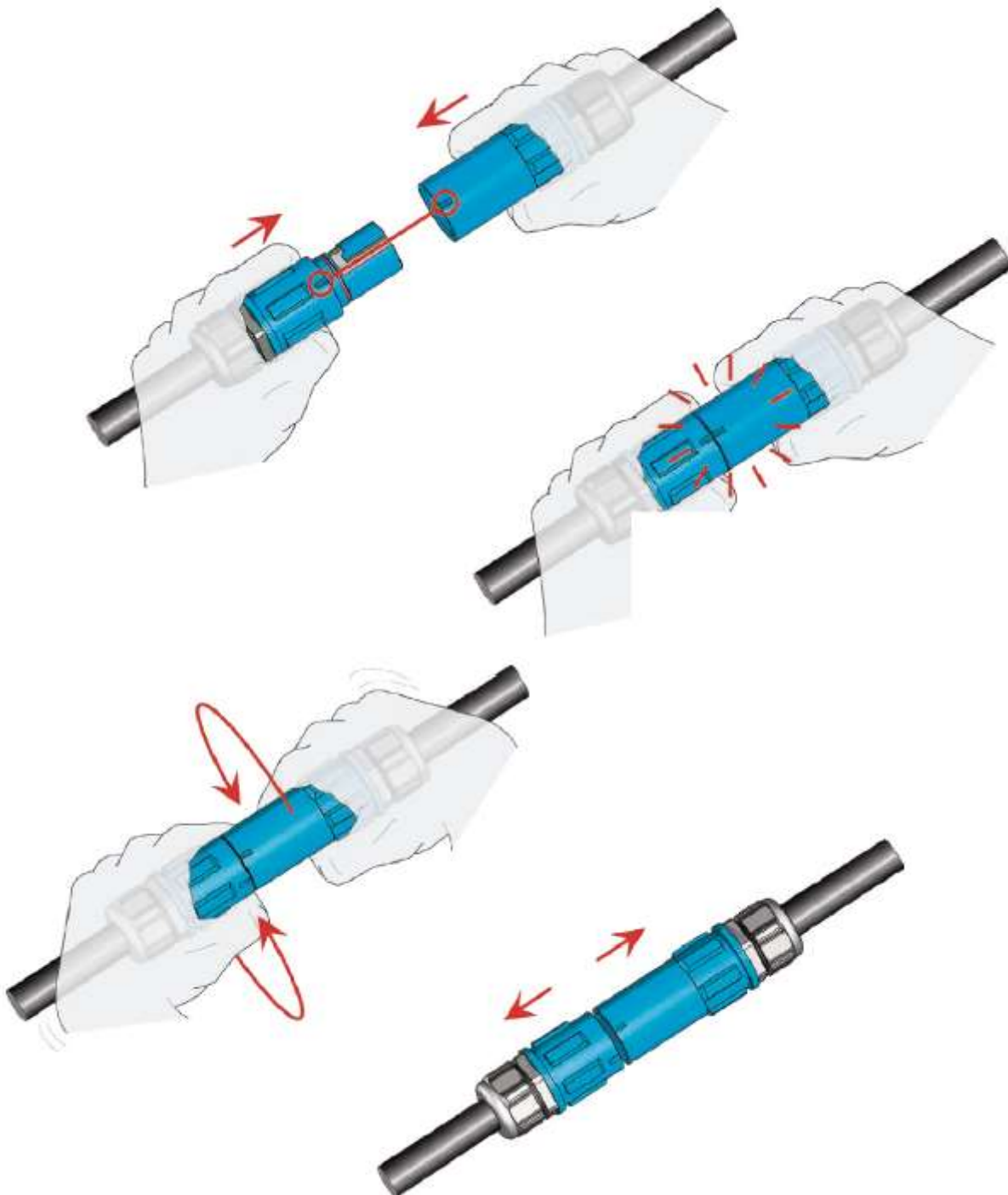

Introduction

SPPC – Single Pole Power Connectors

Unwanted uncoupling prevention: a simple trap makes the system safer.

The connectors can only be separated by removing it with a suitable tool.



Contact Removal

The contacts are inserted from the rear and snap into position within the insulator with no requirements for any cotter/dowel pin or assembly tool.

The contacts are removed from the insulator by using a simple tool to release the retaining clip.

- Improved mechanical insulator strength
- Reliable sealing
- Improved electrical integrity of the insulator
- Reduced assembly times
- The contacts can be removed and replaced

No replacement parts (cotter/dowel pins) are required.

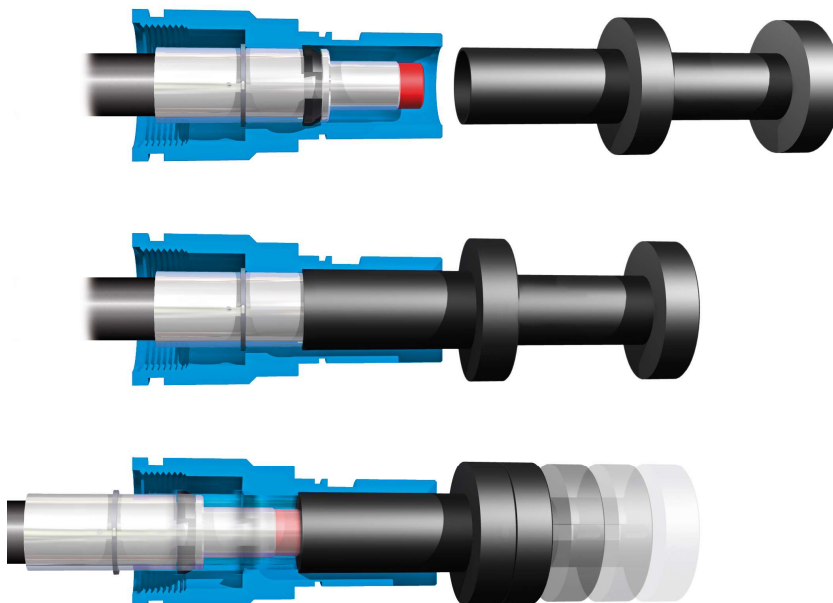

Characteristics

SPPC - HK

| Series | Connector Type | Key Position | Insulator Color | Contact Termination | Cable external diameter | Modification Number* |
|---------|----------------|--------------|-----------------|---------------------|-------------------------|----------------------|
| SPPC-HK | LS | L1 | BR | C-120 | M | |

| | |
|--------------------------|----|
| <i>Cable/Line Source</i> | LS |
| <i>Cable/Line Drain</i> | LD |
| <i>Panel Source</i> | PS |
| <i>Panel Drain</i> | PD |

| | |
|----------------|----|
| <i>Earth</i> | E |
| <i>Neutral</i> | N |
| <i>Phase 1</i> | L1 |
| <i>Phase 2</i> | L2 |
| <i>Phase 3</i> | L3 |

| | | |
|---------------|----|-------------------------------------------------------------------------------------|
| <i>Brown</i> | BR |  |
| <i>Black</i> | BK |  |
| <i>Grey</i> | GY |  |
| <i>Blue</i> | BU |  |
| <i>Green</i> | GR |  |
| <i>Red</i> | RD |  |
| <i>Yellow</i> | YL |  |
| <i>White</i> | WH |  |





| | |
|----------------------------------------------------------------------|--------|
| <i>M12 post – 250A up to 70mm²</i> | M12-T2 |
| <i>M12 post – 400A up to 120mm²</i> | M12-T4 |
| <i>Screw terminal – 250A up to 70mm²*</i> | S-70 |
| <i>Crimp contacts – 400A 95mm²- 120mm²</i> | C-120 |

| | |
|--------------------|----|
| <i>7mm – 15mm</i> | S |
| <i>11mm – 21mm</i> | M |
| <i>15mm – 25mm</i> | OS |





Product Range
PANEL SOURCE CONNECTORS - 250A
M12 post for conductor up to 70mm²

| Color* | Designation | Order Number |
|----------------------------------------------------------------------------------------------------|-------------------------|--------------|
| Brown – Phase L1  | SPPC-HK-PS-L1-BR-M12-T2 | 440004 |
| Black – Phase L2  | SPPC-HK-PS-L2-BK-M12-T2 | 440017 |
| Grey – Phase L3  | SPPC-HK-PS-L3-GY-M12-T2 | 440071 |
| Blue – Neutral  | SPPC-HK-PS-N-BU-M12-T2 | 440072 |
| Green – Earth  | SPPC-HK-PS-E-GN-M12-T2 | 440018 |

PANEL SOURCE CONNECTORS – 400A
M12 post for conductor up to 120mm²

| Color* | Designation | Order Number |
|-----------------------------------------------------------------------------------------------------|-------------------------|--------------|
| Brown – Phase L1  | SPPC-HK-PS-L1-BR-M12-T4 | 440033 |
| Black – Phase L2  | SPPC-HK-PS-L2-BK-M12-T4 | 440034 |
| Grey – Phase L3  | SPPC-HK-PS-L3-GY-M12-T4 | 440035 |
| Blue – Neutral  | SPPC-HK-PS-N-BU-M12-T4 | 440032 |
| Green – Earth  | SPPC-HK-PS-E-GN-M12-T4 | 440031 |

PANEL DRAIN CONNECTORS - 250A
M12 post for conductor up to 70mm²

| Color* | Designation | Order Number |
|------------------------------------------------------------------------------------------------------|-------------------------|--------------|
| Brown – Phase L1  | SPPC-HK-PD-L1-BR-M12-T2 | 440024 |
| Black – Phase L2  | SPPC-HK-PD-L2-BK-M12-T2 | 440025 |
| Grey – Phase L3  | SPPC-HK-PD-L3-GY-M12-T2 | 440069 |
| Blue – Neutral  | SPPC-HK-PD-N-BU-M12-T2 | 440070 |
| Green – Earth  | SPPC-HK-PD-E-GN-M12-T2 | 440001 |

PANEL DRAIN CONNECTORS – 400A
M12 post for conductor up to 120mm²







| Color* | Designation | Order Number |
|------------------------------------------------------------------------------------------------------|-------------------------|--------------|
| Brown – Phase L1  | SPPC-HK-PD-L1-BR-M12-T4 | 440011 |
| Black – Phase L2  | SPPC-HK-PD-L2-BK-M12-T4 | 440065 |
| Grey – Phase L3  | SPPC-HK-PD-L3-GY-M12-T4 | 440066 |
| Blue – Neutral  | SPPC-HK-PD-N-BU-M12-T4 | 440068 |
| Green – Earth  | SPPC-HK-PD-E-GN-M12-T4 | 440067 |

Characteristics

CABLE/LINE DRAIN CONNECTORS - 250A

Screws terminal for conductor up to 70mm²



| Color* | Designation | Order Number |
|----------------------------------------------------------------------------------------------------|-------------------------|--------------|
| Brown – Phase L1  | SPPC-HK-LD-L1-BR-S-70-M | 440002 |
| Black – Phase L2  | SPPC-HK-LD-L2-BK-S-70-M | 440054 |
| Grey – Phase L3  | SPPC-HK-LD-L3-GY-S-70-M | 440073 |
| Blue – Neutral  | SPPC-HK-LD-N-BU-S-70-M | 440074 |
| Green – Earth  | SPPC-HK-LD-E-GN-S-70-M | 440036 |

Sleeves included, for cable conductor size 16mm² - 25mm² - 35mm² - 50mm² - 70mm²

CABLE/LINE DRAIN CONNECTORS – 400A

Crimp contacts 95mm² - 120mm²



| Color* | Designation | Order Number |
|-----------------------------------------------------------------------------------------------------|---------------------------|--------------|
| Brown – Phase L1  | SPPC-HK-LD-L1-BR-C-120-OS | 440028 |
| Black – Phase L2  | SPPC-HK-LD-L2-BK-C-120-OS | 440029 |
| Grey – Phase L3  | SPPC-HK-LD-L3-GY-C-120-OS | 440030 |
| Blue – Neutral  | SPPC-HK-LD-N-BU-C-120-OS | 440027 |
| Green – Earth  | SPPC-HK-LD-E-GN-C-120-OS | 440026 |

CABLE/LINE SOURCE CONNECTORS – 250A

Screws terminal for conductor up to 70mm²



| Color* | Designation | Order Number |
|------------------------------------------------------------------------------------------------------|-------------------------|--------------|
| Brown – Phase L1  | SPPC-HK-LS-L1-BR-S-70-M | 440075 |
| Black – Phase L2  | SPPC-HK-LS-L2-BK-S-70-M | 440055 |
| Grey – Phase L3  | SPPC-HK-LS-L3-GY-S-70-M | 440076 |
| Blue – Neutral  | SPPC-HK-LS-N-BU-S-70-M | 440077 |
| Green – Earth  | SPPC-HK-LS-E-GN-S-70-M | 440078 |

Sleeves included, for cable conductor size 16mm² - 25mm² - 35mm² - 50mm² - 70mm²

CABLE/LINE SOURCE CONNECTORS – 400A

Crimp contacts 95mm² - 120mm²



| Color* | Designation | Order Number |
|------------------------------------------------------------------------------------------------------|---------------------------|--------------|
| Brown – Phase L1  | SPPC-HK-LS-L1-BR-C-120-OS | 440056 |
| Black – Phase L2  | SPPC-HK-LS-L2-BK-C-120-OS | 440057 |
| Grey – Phase L3  | SPPC-HK-LS-L3-GY-C-120-OS | 440062 |
| Blue – Neutral  | SPPC-HK-LS-N-BU-C-120-OS | 440064 |
| Green – Earth  | SPPC-HK-LS-E-GN-C-120-OS | 440063 |

REMOVAL TOOL

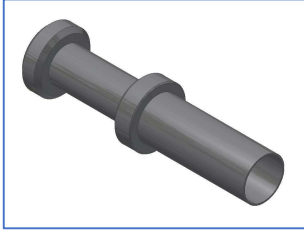

| Type | Designation | Order Number |
|--------------------------|-------------|--------------|
| Crimp and Screw contacts | SPPC-HK-RT | 750070 |

CRIMPING TOOL

Due to the numerous cable types available, it is recommended to contact us to confirm cable and crimp suitability.

| | | | |
|------------------------------|-------------------------|-------------------|-------------------------------|
| Cable Size | Up to 70mm ² | 95mm ² | 120mm ² AWG 4/0 |
| Insulation Strip (dim C) | 26mm | 20mm | 20mm |
| Recommended Number of Crimps | N/A (set screw) | 2 | 2 |
| Hand Operated Crimp Tool | N/A | HT120 | HT120 |
| Crimp Die Set | N/A | ME24-C | ME29-C |
| Contact Removal Tool | 750070 | 750070 | 750070 |

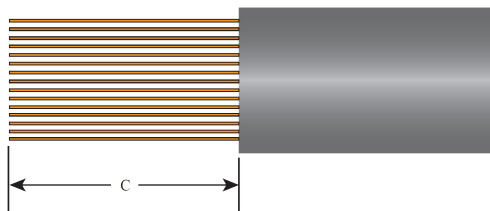

c

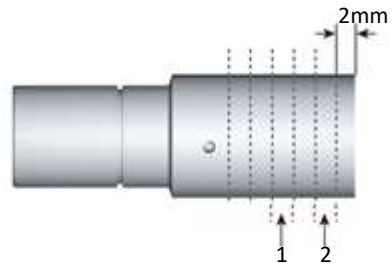

Characteristics

CABLE GLAND FOR INLINE CONNECTORS



| Type | Designation | Order Number |
|----------------------------|----------------|--------------|
| M32 threaded 7mm – 15mm | SPPC-HK-M32-S | 750061 |
| M32 threaded 11mm-21mm | SPPC-HK-M32-M | 750060 |
| M32 threaded 15mm-25mm | SPPC-HK-M32-OS | * |

* On request

PANEL GASKET



| Type | Designation | Order Number |
|------------------|-------------|--------------|
| Neoprene Gaskets | SPPC-HK-PG | |

SLEEVE FOR SCREW CONTACTS



| Type | Designation | Order Number |
|----------|----------------|--------------|
| Sleeve** | SPPC-HK-SLEEVE | 750063 |

** Sleeves for cable conductor size 16mm² - 25mm² - 35mm² - 50mm² - 70mm²

Derating data for 85°C rubber insulated cables.

CHARACTERISTICS

| | |
|-------------------------------------------------|--------------------------------------------------------------|
| Insulation | 1250V |
| Maximum panel thickness to guarantee insulation | 6mm |
| Panel contact tightening torque | 30Nm Max |
| Screws tightening torque (in-line connectors) | 12Nm |
| Contact retention in Insulator | 400N axial load |
| Inline contact retention | Plastic Clip |
| Panel mount contact retention | Dowel Pin |
| Contact release | Front |
| M32 Clamping range | 7mm ÷ 25mm |
| Flammability | UL94 V0 |
| Environmental sealing (when mated) | IP67 |
| Connector protection (unmated) | IP2X |
| Rated voltage to Earth | 1750VAC, panel thickness<4mm 1250VAC, panel thickness>4mm |
| Contact resistance | <0.1mOhms |
| Short circuit current | 11KA -1 seconds |
| Short circuit current | 4KA – 3 seconds |
| Surge current (din VDE 0102/1.90) | 45KA – 10 mseconds |
| Temperature range | -30°C/+120°C |

Characteristics

LUG-IT - Power cable joining system



Lugit is a safe and efficient means to make temporary connection / extensions of single core power cables that are pre-terminated with copper lug terminals.

APPLICATIONS

- Power distribution
- Utilities
- Electric Vehicles
- Railway Equipment
- Military Field Power
- Mobile Generators
- Loadbanks
- Back-up Power Systems

Key characteristics

- Increase cable utilization
- Reusable
- Suitable for temporary connections
- Standardize on cable lengths held in stock
- Decrease cable purchase
- Reduce transportation of cables between sites
- No need for connectors or junction boxes
- Daisy chain hook up system

Details

- IP67 Protected when assembled.
- Nominal Voltage Un: 1000Vac
- 2 Lug-it sizes available according to the lug and cable dimensions:
 - LJP-120 from 35mm² up to 120mm²
 - LJP-300 from 150mm² up to 300mm².
- Insulating voltage: 5.000Vac
- Rated current (to be checked with the specific cable characteristics):
 - Lugs 120 mm²:350A (30°C)
 - Lugs 185 mm²:570A (30°C)
 - Lugs 240 mm²:670A (30°C)
 - Lugs 300 mm²:780A (30°C)
- Working temperature: -30°C ÷ +120°C
- Protection degree: IP67 (EN 60529)
- Audible and tactile indication of locking
- Secure lock for unwanted / unauthorised release
- Quick assembly in approx. 2 minutes without special tools. The system can be disassembled and reused

Product Range

LUG-IT 300

Lock the central locking ring using the remote release key.



Lug Palm Width 45mm max, Bolt Hole 12mm,



Characteristics

LUG-IT 120

Lock the central locking ring using the remote release key.



Lug Palm Width 30mm max, Bolt Hole 10mm or 12mm,



Product Range

LUG-IT 300

*Accepts cables 185mm², 240mm² and 300mm², for lugs with 12mm holes,
Lug Palm Width 45mm max, Bolt Hole 12mm,
External Cable Ø 20mm – 32mm.*



| Designation | Order Number |
|--------------|--------------|
| SPPC-LJP-300 | 354801 |

LUG-IT 120

*Accepts cable 35mm² up to 120mm², for lugs with 8,2mm holes,
Lug Palm Width 30mm max, Bolt Hole 10mm or 12mm,
External Cable Ø 16mm – 23mm.*



| Designation | Order Number |
|--------------|--------------|
| SPPC-LJP-120 | 354804 |

LUG-IT KEY

remote locking/release key



| Designation | Order Number |
|--------------|--------------|
| SPPC-LJP-KEY | 750082 |

SAFETY**Information regarding the use of the product within recommended safety limits**

To use the connectors described in this catalogue according to the necessary safety requirements we suggest you apply the following criteria:

- use the connectors and connected cables within their electrical and environmental limits
- follow the characteristics of each version (shell, class and type of strain relief) and carefully choose the appropriate connector for the required use
- make sure to respect the procedures regarding the correct assembly of connectors and the crimping of contacts
- any connector damaged during shipment, storage, assembly or use should be replaced
- never uncouple the connectors when under power
- always protect the parts against shock when the circuit is under power
- always check the circuit before putting it under power
- consult Radiall VanSystem Srl if in doubt
- the user must take final responsibility for electrical safety Radiall VanSystem Srl reserves the right to amend the specifications of this catalogue without issuing prior notice.

For the instructions concerning assembly and crimping of contacts please consult the appropriate tools manuals.

We recommend to respect the following general rules:

- to be used always the tools recommended by Radiall VanSystem's catalogue or manuals
- to be applied the suggested norms for tool maintenance and calibration

DO NOT USE ALTERNATIVE GREASES OR OILS which could damage the insert and affect the functionality of the connector.

Radiall VanSystem Srl reserves the right to amend the specifications of this catalogue without issuing prior notice.



www.radiall.com

FRANCE

RADIALL S.A.

Tel +33 1 49 35 35 35

info@radiall.com



www.vansystem.eu

ITALY

Radiall VanSystem S.r.l.

Tel. +39 02 3569931

info.vansystem@radiall.com



Компания «ЭлектроПласт» предлагает заключение долгосрочных отношений при поставках импортных электронных компонентов на взаимовыгодных условиях!

Наши преимущества:

- Оперативные поставки широкого спектра электронных компонентов отечественного и импортного производства напрямую от производителей и с крупнейших мировых складов;
- Поставка более 17-ти миллионов наименований электронных компонентов;
- Поставка сложных, дефицитных, либо снятых с производства позиций;
- Оперативные сроки поставки под заказ (от 5 рабочих дней);
- Экспресс доставка в любую точку России;
- Техническая поддержка проекта, помощь в подборе аналогов, поставка прототипов;
- Система менеджмента качества сертифицирована по Международному стандарту ISO 9001;
- Лицензия ФСБ на осуществление работ с использованием сведений, составляющих государственную тайну;
- Поставка специализированных компонентов (Xilinx, Altera, Analog Devices, Intersil, Interpoint, Microsemi, Aeroflex, Peregrine, Syfer, Eurofarad, Texas Instrument, Miteq, Cobham, E2V, MA-COM, Hittite, Mini-Circuits, General Dynamics и др.);

Помимо этого, одним из направлений компании «ЭлектроПласт» является направление «Источники питания». Мы предлагаем Вам помощь Конструкторского отдела:

- Подбор оптимального решения, техническое обоснование при выборе компонента;
- Подбор аналогов;
- Консультации по применению компонента;
- Поставка образцов и прототипов;
- Техническая поддержка проекта;
- Защита от снятия компонента с производства.



Как с нами связаться

Телефон: 8 (812) 309 58 32 (многоканальный)

Факс: 8 (812) 320-02-42

Электронная почта: org@eplast1.ru

Адрес: 198099, г. Санкт-Петербург, ул. Калинина, дом 2, корпус 4, литера А.