

Single Resistor Gain Programmable, Precision Instrumentation Amplifier

FEATURES

- **Single Gain Set Resistor: $G = 1$ to 10,000**
- **Gain Error: $G = 10$, 0.08% Max**
- **Input Offset Voltage Drift: 0.3 μ V/ $^{\circ}$ C Max**
- **Meets IEC 1000-4-2 Level 4 ESD Tests with Two External 5k Resistors**
- **Gain Nonlinearity: $G = 10$, 10ppm Max**
- **Input Offset Voltage: $G = 10$, 60 μ V Max**
- **Input Bias Current: 350pA Max**
- **PSRR at $G = 1$: 105dB Min**
- **CMRR at $G = 1$: 90dB Min**
- **Supply Current: 1.3mA Max**
- **Wide Supply Range: ± 2.3 V to ± 18 V**
- **1kHz Voltage Noise: 7.5nV/ $\sqrt{\text{Hz}}$**
- **0.1Hz to 10Hz Noise: 0.28 μ V_{P-P}**
- **Available in 8-Pin PDIP and SO Packages**

APPLICATIONS

- Bridge Amplifiers
- Strain Gauge Amplifiers
- Thermocouple Amplifiers
- Differential to Single-Ended Converters
- Medical Instrumentation

LT, LT, LTC, LTM, Linear Technology and the Linear logo are registered trademarks of Linear Technology Corporation. All other trademarks are the property of their respective owners.

DESCRIPTION

The LT[®]1167 is a low power, precision instrumentation amplifier that requires only one external resistor to set gains of 1 to 10,000. The low voltage noise of 7.5nV/ $\sqrt{\text{Hz}}$ (at 1kHz) is not compromised by low power dissipation (0.9mA typical for ± 2.3 V to ± 15 V supplies).

The part's high accuracy (10ppm maximum nonlinearity, 0.08% max gain error ($G = 10$)) is not degraded even for load resistors as low as 2k. The LT1167 is laser trimmed for very low input offset voltage (40 μ V max), drift (0.3 μ V/ $^{\circ}$ C), high CMRR (90dB, $G = 1$) and PSRR (105dB, $G = 1$). Low input bias currents of 350pA max are achieved with the use of superbeta processing. The output can handle capacitive loads up to 1000pF in any gain configuration while the inputs are ESD protected up to 13kV (human body). The LT1167 with two external 5k resistors passes the IEC 1000-4-2 level 4 specification.

The LT1167, offered in 8-pin PDIP and SO packages, requires significantly less PC board area than discrete multi op amp and resistor designs.

The LT1167-1 offers the same performance as the LT1167, but its input current characteristic at high common mode voltage better supports applications with high input impedance (see the Applications Information section).

TYPICAL APPLICATION

Single Supply Barometer



Gain Nonlinearity

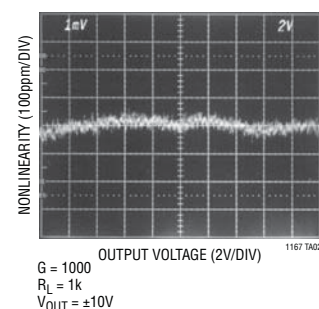

LT1167

ABSOLUTE MAXIMUM RATINGS

(Note 1)

| | |
|--|----------------------------------|
| Supply Voltage | $\pm 20V$ |
| Differential Input Voltage (Within the Supply Voltage) | $\pm 40V$ |
| Input Voltage (Equal to Supply Voltage)..... | $\pm 20V$ |
| Input Current (Note 3)..... | $\pm 20mA$ |
| Output Short-Circuit Duration | Indefinite |
| Operating Temperature Range | $-40^{\circ}C$ to $85^{\circ}C$ |
| Specified Temperature Range | |
| LT1167AC/LT1167C/ | |
| LT1167AC-1/LT1167C-1 (Note 4) | $0^{\circ}C$ to $70^{\circ}C$ |
| LT1167AI/LT1167I/ | |
| LT1167AI-1/LT1167I-1 | $-40^{\circ}C$ to $85^{\circ}C$ |
| Storage Temperature Range..... | $-65^{\circ}C$ to $150^{\circ}C$ |
| Lead Temperature (Soldering, 10 sec) | $300^{\circ}C$ |

PIN CONFIGURATION



ORDER INFORMATION

| LEAD FREE FINISH | TAPE AND REEL | PART MARKING | PACKAGE DESCRIPTION | SPECIFIED TEMPERATURE RANGE |
|-------------------|--------------------|--------------|---------------------|---------------------------------|
| LT1167ACN8#PBF | LT1167ACN8#TRPBF | LT1167AC | 8-Lead PDIP | $0^{\circ}C$ to $70^{\circ}C$ |
| LT1167ACS8#PBF | LT1167ACS8#TRPBF | 1167A | 8-Lead Plastic SO | $0^{\circ}C$ to $70^{\circ}C$ |
| LT1167AIN8#PBF | LT1167AIN8#TRPBF | LT1167AI | 8-Lead PDIP | $-40^{\circ}C$ to $85^{\circ}C$ |
| LT1167AIS8#PBF | LT1167AIS8#TRPBF | 1167AI | 8-Lead Plastic SO | $-40^{\circ}C$ to $85^{\circ}C$ |
| LT1167CN8#PBF | LT1167CN8#TRPBF | LT1167C | 8-Lead PDIP | $0^{\circ}C$ to $70^{\circ}C$ |
| LT1167CS8#PBF | LT1167CS8#TRPBF | 1167 | 8-Lead Plastic SO | $0^{\circ}C$ to $70^{\circ}C$ |
| LT1167IN8#PBF | LT1167IN8#TRPBF | LT1167I | 8-Lead PDIP | $-40^{\circ}C$ to $85^{\circ}C$ |
| LT1167IS8#PBF | LT1167IS8#TRPBF | 1167I | 8-Lead Plastic SO | $-40^{\circ}C$ to $85^{\circ}C$ |
| LT1167CS8-1#PBF | LT1167CS8-1#TRPBF | 11671 | 8-Lead Plastic SO | $0^{\circ}C$ to $70^{\circ}C$ |
| LT1167IS8-1#PBF | LT1167IS8-1#TRPBF | 11671 | 8-Lead Plastic SO | $-40^{\circ}C$ to $85^{\circ}C$ |
| LT1167ACS8-1#PBF | LT1167ACS8-1#TRPBF | 11671 | 8-Lead Plastic SO | $0^{\circ}C$ to $70^{\circ}C$ |
| LT1167AIS8-1#PBF | LT1167AIS8-1#TRPBF | 11671 | 8-Lead Plastic SO | $-40^{\circ}C$ to $85^{\circ}C$ |
| LEAD BASED FINISH | TAPE AND REEL | PART MARKING | PACKAGE DESCRIPTION | SPECIFIED TEMPERATURE RANGE |
| LT1167ACN8 | LT1167ACN8#TR | LT1167AC | 8-Lead PDIP | $0^{\circ}C$ to $70^{\circ}C$ |
| LT1167ACS8 | LT1167ACS8#TR | 1167A | 8-Lead Plastic SO | $0^{\circ}C$ to $70^{\circ}C$ |
| LT1167AIN8 | LT1167AIN8#TR | LT1167AI | 8-Lead PDIP | $-40^{\circ}C$ to $85^{\circ}C$ |
| LT1167AIS8 | LT1167AIS8#TR | 1167AI | 8-Lead Plastic SO | $-40^{\circ}C$ to $85^{\circ}C$ |
| LT1167CN8 | LT1167CN8#TR | LT1167C | 8-Lead PDIP | $0^{\circ}C$ to $70^{\circ}C$ |
| LT1167CS8 | LT1167CS8#TR | 1167 | 8-Lead Plastic SO | $0^{\circ}C$ to $70^{\circ}C$ |
| LT1167IN8 | LT1167IN8#TR | LT1167I | 8-Lead PDIP | $-40^{\circ}C$ to $85^{\circ}C$ |
| LT1167IS8 | LT1167IS8#TR | 1167I | 8-Lead Plastic SO | $-40^{\circ}C$ to $85^{\circ}C$ |

Consult LTC Marketing for parts specified with wider operating temperature ranges. *The temperature grade is identified by a label on the shipping container. Consult LTC Marketing for information on non-standard lead based finish parts.

For more information on lead free part marking, go to: <http://www.linear.com/leadfree/>

For more information on tape and reel specifications, go to: <http://www.linear.com/tapeandree/>

ELECTRICAL CHARACTERISTICS $V_S = \pm 15V$, $V_{CM} = 0V$, $T_A = 25^\circ C$, $R_L = 2k$, unless otherwise noted.

| SYMBOL | PARAMETER | CONDITIONS (NOTE 7) | LT1167AC/LTC1167AI LT1167AC-1/LTC1167AI-1 | | | LT1167C/LTC1167I LT1167C-1/LTC1167I-1 | | | UNITS | |
|---|---|---|--|-------|--------------|--|-------|--------------|----------------|-----|
| | | | MIN | TYP | MAX | MIN | TYP | MAX | | |
| G | Gain Range | $G = 1 + (49.4k/R_G)$ | 1 | | 10k | 1 | | 10k | | |
| | Gain Error | $G = 1$ | | 0.008 | 0.02 | | 0.015 | 0.03 | % | |
| | | $G = 10$ (Note 2) | | | 0.010 | 0.08 | | 0.020 | 0.10 | % |
| | | $G = 100$ (Note 2) | | | 0.025 | 0.08 | | 0.030 | 0.10 | % |
| $G = 1000$ (Note 2) | | | | 0.049 | 0.10 | | 0.040 | 0.10 | % | |
| Gain Nonlinearity (Note 5) | $V_O = \pm 10V$, $G = 1$ $V_O = \pm 10V$, $G = 10$ and 100 $V_O = \pm 10V$, $G = 1000$ | | 1 | | 6 | | 1.5 | 10 | ppm | |
| | | | 2 | | 10 | | 3 | 15 | ppm | |
| | | | 15 | | 40 | | 20 | 60 | ppm | |
| | | $V_O = \pm 10V$, $G = 1$, $R_L = 600$ $V_O = \pm 10V$, $G = 10$ and 100, $R_L = 600$ $V_O = \pm 10V$, $G = 1000$, $R_L = 600$ | 5 | | 12 | | 6 | | 15 | ppm |
| | | 6 | | 15 | | 7 | | 20 | ppm | |
| | | 20 | | 65 | | 25 | | 80 | ppm | |
| V_{OST} | Total Input Referred Offset Voltage | $V_{OST} = V_{OSI} + V_{OSO}/G$ | | | | | | | | |
| V_{OSI} | Input Offset Voltage | $G = 1000$, $V_S = \pm 5V$ to $\pm 15V$ | | 15 | 40 | | 20 | 60 | μV | |
| V_{OSO} | Output Offset Voltage | $G = 1$, $V_S = \pm 5V$ to $\pm 15V$ | | 40 | 200 | | 50 | 300 | μV | |
| I_{OS} | Input Offset Current | | | 90 | 320 | | 100 | 450 | μA | |
| I_B | Input Bias Current | | | 50 | 350 | | 80 | 500 | μA | |
| e_n | Input Noise Voltage (Note 8) | 0.1Hz to 10Hz, $G = 1$ | | 2.00 | | | 2.00 | | μV_{P-P} | |
| | | 0.1Hz to 10Hz, $G = 10$ | | 0.50 | | | 0.50 | | μV_{P-P} | |
| | | 0.1Hz to 10Hz, $G = 100$ | | 0.28 | | | 0.28 | | μV_{P-P} | |
| | | and 1000 | | | | | | | | |
| Total RTI Noise = $\sqrt{e_{ni}^2 + (e_{no}/G)^2}$ (Note 8) | | | | | | | | | | |
| e_{ni} | Input Noise Voltage Density (Note 8) | $f_0 = 1kHz$ | | 7.5 | 12 | | 7.5 | 12 | nV/\sqrt{Hz} | |
| e_{no} | Output Noise Voltage Density (Note 8) | $f_0 = 1kHz$ (Note 3) | | 67 | 90 | | 67 | 90 | nV/\sqrt{Hz} | |
| i_n | Input Noise Current | $f_0 = 0.1Hz$ to 10Hz | | 10 | | | 10 | | pA_{P-P} | |
| | Input Noise Current Density | $f_0 = 10Hz$ | | 124 | | | 124 | | fA/\sqrt{Hz} | |
| R_{IN} | Input Resistance | $V_{IN} = \pm 10V$ | 200 | 1000 | | 200 | 1000 | | $G\Omega$ | |
| $C_{IN(DIFF)}$ | Differential Input Capacitance | $f_0 = 100kHz$ | | 1.6 | | | 1.6 | | pF | |
| $C_{IN(CM)}$ | Common Mode Input Capacitance | $f_0 = 100kHz$ | | 1.6 | | | 1.6 | | pF | |
| V_{CM} | Input Voltage Range | $G = 1$, Other Input Grounded $V_S = \pm 2.3V$ to $\pm 5V$ $V_S = \pm 5V$ to $\pm 18V$ | $-V_S + 1.9$ | | $+V_S - 1.2$ | $-V_S + 1.9$ | | $+V_S - 1.2$ | V | |
| | | | $-V_S + 1.9$ | | $+V_S - 1.4$ | $-V_S + 1.9$ | | $+V_S - 1.4$ | V | |
| CMRR | Common Mode Rejection Ratio | 1k Source Imbalance, $V_{CM} = 0V$ to $\pm 10V$ $G = 1$ $G = 10$ $G = 100$ $G = 1000$ | | 90 | 95 | | 85 | 95 | dB | |
| | | | | | 106 | 115 | | 100 | 115 | dB |
| | | | | | 120 | 125 | | 110 | 125 | dB |
| | | | | | 126 | 140 | | 120 | 140 | dB |
| | | | | | | | | | | |
| PSRR | Power Supply Rejection Ratio | $V_S = \pm 2.3V$ to $\pm 18V$ $G = 1$ $G = 10$ $G = 100$ $G = 1000$ | | 105 | 120 | | 100 | 120 | dB | |
| | | | | | 125 | 135 | | 120 | 135 | dB |
| | | | | | 131 | 140 | | 126 | 140 | dB |
| | | | | | 135 | 150 | | 130 | 150 | dB |
| | | | | | | | | | | |
| I_S | Supply Current | $V_S = \pm 2.3V$ to $\pm 18V$ | | 0.9 | 1.3 | | 0.9 | 1.3 | mA | |
| V_{OUT} | Output Voltage Swing | $R_L = 10k$ $V_S = \pm 2.3V$ to $\pm 5V$ $V_S = \pm 5V$ to $\pm 18V$ | $-V_S + 1.1$ | | $+V_S - 1.2$ | $-V_S + 1.1$ | | $+V_S - 1.2$ | V | |
| | | | $-V_S + 1.2$ | | $+V_S - 1.3$ | $-V_S + 1.2$ | | $+V_S - 1.3$ | V | |

ELECTRICAL CHARACTERISTICS $V_S = \pm 15V, V_{CM} = 0V, T_A = 25^\circ C, R_L = 2k$, unless otherwise noted.

| SYMBOL | PARAMETER | CONDITIONS (NOTE 7) | LT1167AC/LTC1167AI LT1167AC-1/LTC1167AI-1 | | | LT1167C/LTC1167I LT1167C-1/LTC1167I-1 | | | UNITS |
|-------------|----------------------------|--|--|----------------|--------------|--|----------------|--------------|--------------------|
| | | | MIN | TYP | MAX | MIN | TYP | MAX | |
| I_{OUT} | Output Current | | 20 | 27 | | 20 | 27 | | mA |
| BW | Bandwidth | $G = 1$ | | 1000 | | | 1000 | | kHz |
| | | $G = 10$ | | 800 | | | 800 | | kHz |
| | | $G = 100$ | | 120 | | | 120 | | kHz |
| | | $G = 1000$ | | 12 | | | 12 | | kHz |
| SR | Slew Rate | $G = 1, V_{OUT} = \pm 10V$ | 0.75 | 1.2 | | 0.75 | 1.2 | | V/ μs |
| | Settling Time to 0.01% | 10V Step $G = 1$ to 100 $G = 1000$ | | 14 130 | | | 14 130 | | μs μs |
| R_{REFIN} | Reference Input Resistance | | | 20 | | | 20 | | k Ω |
| I_{REFIN} | Reference Input Current | $V_{REF} = 0V$ | | 50 | | | 50 | | μA |
| V_{REF} | Reference Voltage Range | | $-V_S + 1.6$ | | $+V_S - 1.6$ | $-V_S + 1.6$ | | $+V_S - 1.6$ | V |
| A_{VREF} | Reference Gain to Output | | | 1 ± 0.0001 | | | 1 ± 0.0001 | | |

The ● denotes the specifications which apply over the full operating temperature range, otherwise specifications are at $T_A = 25^\circ C$. $V_S = \pm 15V, V_{CM} = 0V, 0^\circ C \leq T_A \leq 70^\circ C, R_L = 2k$, unless otherwise noted.

| SYMBOL | PARAMETER | CONDITIONS (NOTE 7) | | LT1167AC/LT1167AC-1 | | | LT1167C/LT1167C-1 | | | UNITS |
|-------------|-------------------------------------|---|---|---------------------|------|--------------|-------------------|------|--------------|------------------|
| | | | | MIN | TYP | MAX | MIN | TYP | MAX | |
| | Gain Error | $G = 1$ | ● | 0.01 | 0.03 | | 0.012 | 0.04 | | % |
| | | $G = 10$ (Note 2) | ● | 0.08 | 0.30 | | 0.100 | 0.33 | | % |
| | | $G = 100$ (Note 2) | ● | 0.09 | 0.30 | | 0.120 | 0.33 | | % |
| | | $G = 1000$ (Note 2) | ● | 0.14 | 0.33 | | 0.140 | 0.35 | | % |
| | Gain Nonlinearity | $V_{OUT} = \pm 10V, G = 1$ | ● | 1.5 | 10 | | 3 | 15 | | ppm |
| | | $V_{OUT} = \pm 10V, G = 10$ and 100 | ● | 3 | 15 | | 4 | 20 | | ppm |
| | | $V_{OUT} = \pm 10V, G = 1000$ | ● | 20 | 60 | | 25 | 80 | | ppm |
| G/T | Gain vs Temperature | $G < 1000$ (Note 2) | ● | 20 | 50 | | 20 | 50 | | ppm/ $^\circ C$ |
| V_{OST} | Total Input Referred Offset Voltage | $V_{OST} = V_{OSI} + V_{OSO}/G$ | | | | | | | | |
| V_{OSI} | Input Offset Voltage | $V_S = \pm 5V$ to $\pm 15V$ | ● | 18 | 60 | | 23 | 80 | | μV |
| V_{OSIH} | Input Offset Voltage Hysteresis | (Notes 3, 6) | | 3.0 | | | 3.0 | | | μV |
| V_{OSO} | Output Offset Voltage | $V_S = \pm 5V$ to $\pm 15V$ | ● | 60 | 380 | | 70 | 500 | | μV |
| V_{OSOH} | Output Offset Voltage Hysteresis | (Notes 3, 6) | | 30 | | | 30 | | | μV |
| V_{OSI}/T | Input Offset Drift (Note 8) | (Note 3) | ● | 0.05 | 0.3 | | 0.06 | 0.4 | | $\mu V/^\circ C$ |
| V_{OSO}/T | Output Offset Drift | (Note 3) | ● | 0.7 | 3 | | 0.8 | 4 | | $\mu V/^\circ C$ |
| I_{OS} | Input Offset Current | | ● | 100 | 400 | | 120 | 550 | | pA |
| I_{OS}/T | Input Offset Current Drift | | ● | 0.3 | | | 0.4 | | | pA/ $^\circ C$ |
| I_B | Input Bias Current | | ● | 75 | 450 | | 105 | 600 | | pA |
| I_B/T | Input Bias Current Drift | | ● | 0.4 | | | 0.4 | | | pA/ $^\circ C$ |
| V_{CM} | Input Voltage Range | $G = 1$, Other Input Grounded | ● | $-V_S + 2.1$ | | $+V_S - 1.3$ | $-V_S + 2.1$ | | $+V_S - 1.3$ | V |
| | | $V_S = \pm 2.3V$ to $\pm 5V$ $V_S = \pm 5V$ to $\pm 18V$ | ● | $-V_S + 2.1$ | | $+V_S - 1.4$ | $-V_S + 2.1$ | | $+V_S - 1.4$ | V |
| CMRR | Common Mode Rejection Ratio | 1k Source Imbalance, $V_{CM} = 0V$ to $\pm 10V$ | | | | | | | | |
| | | $G = 1$ | ● | 88 | 92 | | 83 | 92 | | dB |
| | | $G = 10$ | ● | 100 | 110 | | 97 | 110 | | dB |
| | | $G = 100$ | ● | 115 | 120 | | 113 | 120 | | dB |
| | | $G = 1000$ | ● | 117 | 135 | | 114 | 135 | | dB |

ELECTRICAL CHARACTERISTICS The ● denotes the specifications which apply over the full operating temperature range, otherwise specifications are at $T_A = 25^\circ\text{C}$. $V_S = \pm 15\text{V}$, $V_{CM} = 0\text{V}$, $0^\circ\text{C} \leq T_A \leq 70^\circ\text{C}$, $R_L = 2\text{k}$, unless otherwise noted.

| SYMBOL | PARAMETER | CONDITIONS (NOTE 7) | LT1167AC/LT1167AC-1 | | | LT1167C/LT1167C-1 | | | UNITS |
|-----------|------------------------------|---|---------------------|--------------|--------------|-------------------|--------------|------------------|-------|
| | | | MIN | TYP | MAX | MIN | TYP | MAX | |
| PSRR | Power Supply Rejection Ratio | $V_S = \pm 2.3\text{V}$ to $\pm 18\text{V}$ | ● | 103 | 115 | 98 | 115 | dB | |
| | | $G = 1$ | ● | 123 | 130 | 118 | 130 | | |
| | | $G = 10$ | ● | 127 | 135 | 124 | 135 | | |
| | | $G = 1000$ | ● | 129 | 145 | 126 | 145 | | |
| I_S | Supply Current | $V_S = \pm 2.3\text{V}$ to $\pm 18\text{V}$ | ● | 1.0 | 1.5 | 1.0 | 1.5 | mA | |
| V_{OUT} | Output Voltage Swing | $R_L = 10\text{k}$ | ● | $-V_S + 1.4$ | $+V_S - 1.3$ | $-V_S + 1.4$ | $+V_S - 1.3$ | V | |
| | | $V_S = \pm 2.3\text{V}$ to $\pm 5\text{V}$ $V_S = \pm 5\text{V}$ to $\pm 18\text{V}$ | ● | $-V_S + 1.6$ | $+V_S - 1.5$ | $-V_S + 1.6$ | $+V_S - 1.5$ | V | |
| I_{OUT} | Output Current | | ● | 16 | 21 | 16 | 21 | mA | |
| SR | Slew Rate | $G = 1$, $V_{OUT} = \pm 10\text{V}$ | ● | 0.65 | 1.1 | 0.65 | 1.1 | V/ μs | |
| V_{REF} | REF Voltage Range | (Note 3) | ● | $-V_S + 1.6$ | $+V_S - 1.6$ | $-V_S + 1.6$ | $+V_S - 1.6$ | V | |

The ● denotes the specifications which apply over the full operating temperature range, otherwise specifications are at $T_A = 25^\circ\text{C}$. $V_S = \pm 15\text{V}$, $V_{CM} = 0\text{V}$, $-40^\circ\text{C} \leq T_A \leq 85^\circ\text{C}$, $R_L = 2\text{k}$, unless otherwise noted.

| SYMBOL | PARAMETER | CONDITIONS (NOTE 7) | LT1167AI/LT1167AI-1 | | | LT1167I/LT1167I-1 | | | UNITS |
|-------------|-------------------------------------|--|---------------------|--------------|--------------|-------------------|--------------|------------------------------|-------|
| | | | MIN | TYP | MAX | MIN | TYP | MAX | |
| | Gain Error | $G = 1$ | ● | 0.014 | 0.04 | 0.015 | 0.05 | % | |
| | | $G = 10$ (Note 2) | ● | 0.130 | 0.40 | 0.140 | 0.42 | % | |
| | | $G = 100$ (Note 2) | ● | 0.140 | 0.40 | 0.150 | 0.42 | % | |
| | | $G = 1000$ (Note 2) | ● | 0.160 | 0.40 | 0.180 | 0.45 | % | |
| G_N | Gain Nonlinearity (Notes 2, 4) | $V_O = \pm 10\text{V}$, $G = 1$ | ● | 2 | 15 | 3 | 20 | ppm | |
| | | $V_O = \pm 10\text{V}$, $G = 10$ and 100 | ● | 5 | 20 | 6 | 30 | ppm | |
| | | $V_O = \pm 10\text{V}$, $G = 1000$ | ● | 26 | 70 | 30 | 100 | ppm | |
| G/T | Gain vs Temperature | $G < 1000$ (Note 2) | ● | 20 | 50 | 20 | 50 | ppm/ $^\circ\text{C}$ | |
| V_{OST} | Total Input Referred Offset Voltage | $V_{OST} = V_{OSI} + V_{OSO}/G$ | | | | | | | |
| V_{OSI} | Input Offset Voltage | | ● | 20 | 75 | 25 | 100 | μV | |
| V_{OSIH} | Input Offset Voltage Hysteresis | (Notes 3, 6) | | 3.0 | | 3.0 | | μV | |
| V_{OSO} | Output Offset Voltage | | ● | 180 | 500 | 200 | 600 | μV | |
| V_{OSOH} | Output Offset Voltage Hysteresis | (Notes 3, 6) | | 30 | | 30 | | μV | |
| V_{OSI}/T | Input Offset Drift (Note 8) | (Note 3) | ● | 0.05 | 0.3 | 0.06 | 0.4 | $\mu\text{V}/^\circ\text{C}$ | |
| V_{OSO}/T | Output Offset Drift | (Note 3) | ● | 0.8 | 5 | 1 | 6 | $\mu\text{V}/^\circ\text{C}$ | |
| I_{OS} | Input Offset Current | | ● | 110 | 550 | 120 | 700 | pA | |
| I_{OS}/T | Input Offset Current Drift | | ● | 0.3 | | 0.3 | | pA/ $^\circ\text{C}$ | |
| I_B | Input Bias Current | | ● | 180 | 600 | 220 | 800 | pA | |
| I_B/T | Input Bias Current Drift | | ● | 0.5 | | 0.6 | | pA/ $^\circ\text{C}$ | |
| V_{CM} | Input Voltage Range | $V_S = \pm 2.3\text{V}$ to $\pm 5\text{V}$ | ● | $-V_S + 2.1$ | $+V_S - 1.3$ | $-V_S + 2.1$ | $+V_S - 1.3$ | V | |
| | | $V_S = \pm 5\text{V}$ to $\pm 18\text{V}$ | ● | $-V_S + 2.1$ | $+V_S - 1.4$ | $-V_S + 2.1$ | $+V_S - 1.4$ | V | |
| CMRR | Common Mode Rejection Ratio | 1k Source Imbalance, $V_{CM} = 0\text{V}$ to $\pm 10\text{V}$ | | | | | | | |
| | | $G = 1$ | ● | 86 | 90 | 81 | 90 | dB | |
| | | $G = 10$ | ● | 98 | 105 | 95 | 105 | dB | |
| | | $G = 100$ | ● | 114 | 118 | 112 | 118 | dB | |
| | | $G = 1000$ | ● | 116 | 133 | 112 | 133 | dB | |

ELECTRICAL CHARACTERISTICS The ● denotes the specifications which apply over the full operating temperature range, otherwise specifications are at $T_A = 25^\circ\text{C}$. $V_S = \pm 15\text{V}$, $V_{CM} = 0\text{V}$, $0^\circ\text{C} \leq T_A \leq 70^\circ\text{C}$, $R_L = 2\text{k}$, unless otherwise noted.

| SYMBOL | PARAMETER | CONDITIONS (NOTE 7) | LT1167AI/LT1167AI-1 | | | LT1167I/LT1167I-1 | | | UNITS |
|------------|------------------------------|--|---------------------|------------|------------|-------------------|------------|------------|------------------|
| | | | MIN | TYP | MAX | MIN | TYP | MAX | |
| PSRR | Power Supply Rejection Ratio | $V_S = \pm 2.3\text{V to } \pm 18\text{V}$ | ● | 100 | 112 | | 95 | 112 | dB |
| | | $G = 1$ | ● | 120 | 125 | | 115 | 125 | dB |
| | | $G = 10$ | ● | 125 | 132 | | 120 | 132 | dB |
| | | $G = 100$ | ● | 128 | 140 | | 125 | 140 | dB |
| $G = 1000$ | ● | | | | | | | dB | |
| I_S | Supply Current | | ● | 1.1 | 1.6 | | 1.1 | 1.6 | mA |
| V_{OUT} | Output Voltage Swing | $V_S = \pm 2.3\text{V to } \pm 5\text{V}$ | ● | $-V_S+1.4$ | $+V_S-1.3$ | | $-V_S+1.4$ | $+V_S-1.3$ | V |
| | | $V_S = \pm 5\text{V to } \pm 18\text{V}$ | ● | $-V_S+1.6$ | $+V_S-1.5$ | | $-V_S+1.6$ | $+V_S-1.5$ | V |
| I_{OUT} | Output Current | | ● | 15 | 20 | | 15 | 20 | mA |
| SR | Slew Rate | $G = 1, V_{OUT} = \pm 10\text{V}$ | ● | 0.55 | 0.95 | | 0.55 | 0.95 | V/ μs |
| V_{REF} | REF Voltage Range | (Note 3) | ● | $-V_S+1.6$ | $+V_S-1.6$ | | $-V_S+1.6$ | $+V_S-1.6$ | V |

Note 1: Stresses beyond those listed under Absolute Maximum Ratings may cause permanent damage to the device. Exposure to any Absolute Maximum Rating condition for extended periods may affect device reliability and lifetime.

Note 2: Does not include the effect of the external gain resistor R_G .

Note 3: This parameter is not 100% tested.

Note 4: The LT1167AC/LT1167C/LT1167AC-1/LT1167C-1 are designed, characterized and expected to meet the industrial temperature limits, but are not tested at -40°C and 85°C . I-grade parts are guaranteed.

Note 5: This parameter is measured in a high speed automatic tester that does not measure the thermal effects with longer time constants. The magnitude of these thermal effects are dependent on the package used, heat sinking and air flow conditions.

Note 6: Hysteresis in offset voltage is created by package stress that differs depending on whether the IC was previously at a higher or lower temperature. Offset voltage hysteresis is always measured at 25°C , but the IC is cycled to 85°C I-grade (or 70°C C-grade) or -40°C I-grade (0°C C-grade) before successive measurement. 60% of the parts will pass the typical limit on the data sheet.

Note 7: Typical parameters are defined as the 60% of the yield parameter distribution.

Note 8: Referred to input.

TYPICAL PERFORMANCE CHARACTERISTICS

Gain Nonlinearity, G = 1



Gain Nonlinearity, G = 10



Gain Nonlinearity, G = 100



Gain Nonlinearity, G = 1000



Gain Nonlinearity vs Temperature

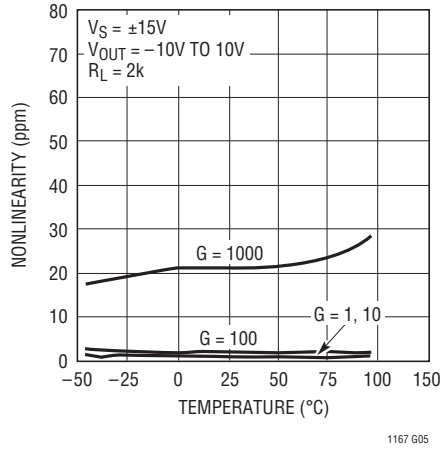

Gain Error vs Temperature

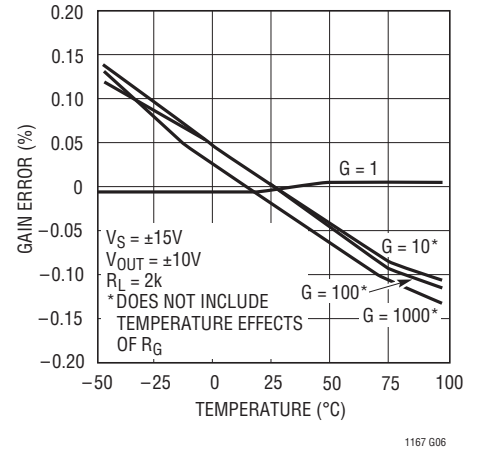

Distribution of Input Offset Voltage, $T_A = -40^\circ C$

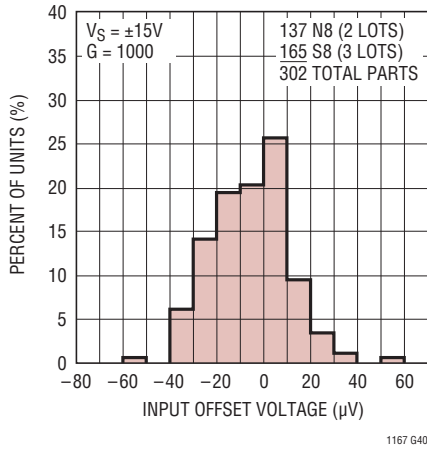

Distribution of Input Offset Voltage, $T_A = 25^\circ C$

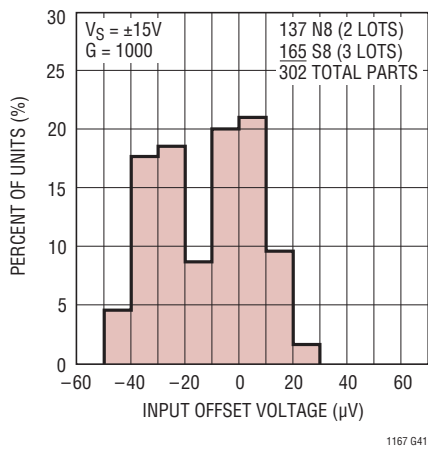

Distribution of Input Offset Voltage, $T_A = 85^\circ C$

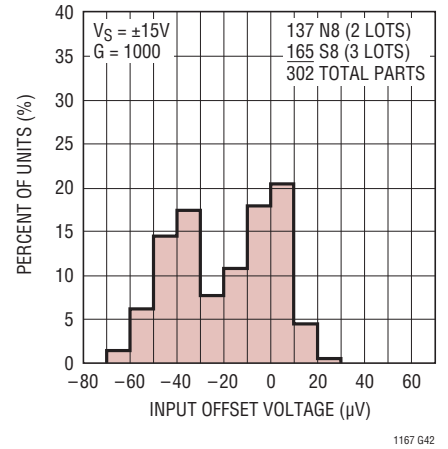

TYPICAL PERFORMANCE CHARACTERISTICS

Distribution of Output Offset Voltage, $T_A = -40^\circ\text{C}$

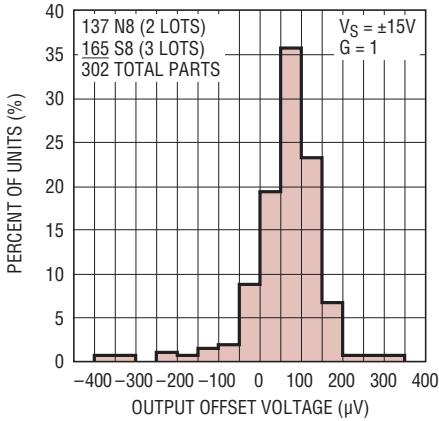

1167 G43

Distribution of Output Offset Voltage, $T_A = 25^\circ\text{C}$

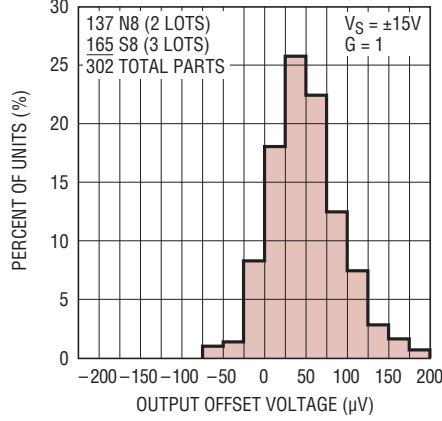

1167 G44

Distribution of Output Offset Voltage, $T_A = 85^\circ\text{C}$

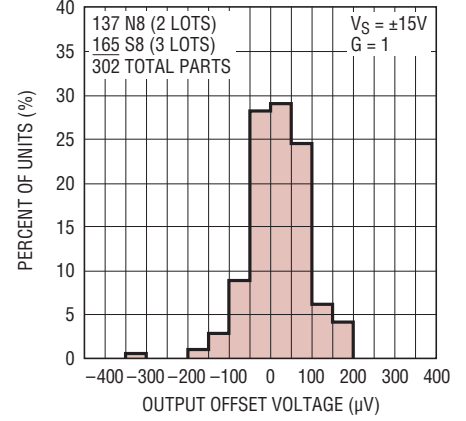

1167 G45

Distribution of Input Offset Voltage Drift

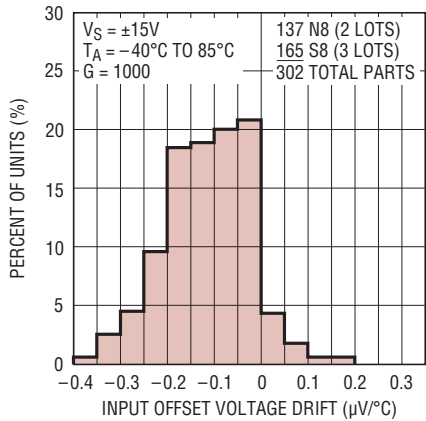

1167 G46

Distribution of Output Offset Voltage Drift

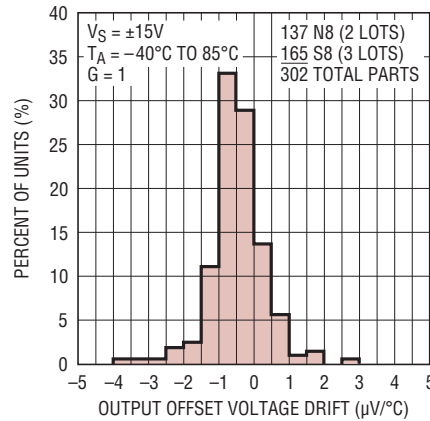

1167 G47

Warm-Up Drift



1167 G09

Input Bias Current



1167 G10

Input Offset Current



1167 G11

Input Bias and Offset Current vs Temperature



1167 G12

TYPICAL PERFORMANCE CHARACTERISTICS

Input Bias Current vs Common Mode Input Voltage



1167 G13

Common Mode Rejection Ratio vs Frequency



1167 G14

Negative Power Supply Rejection Ratio vs Frequency



1167 G15

Positive Power Supply Rejection Ratio vs Frequency

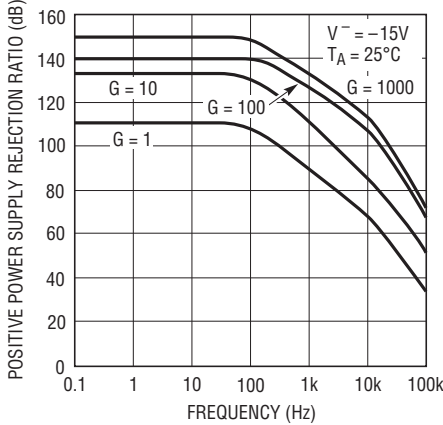

1167 G16

Gain vs Frequency



1167 G17

Supply Current vs Supply Voltage



1167 G18

Voltage Noise Density vs Frequency

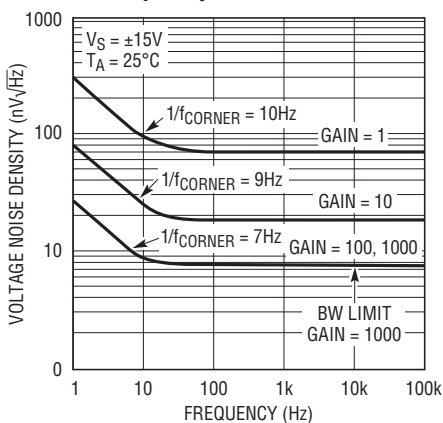

1167 G19

0.1Hz to 10Hz Noise Voltage, G = 1

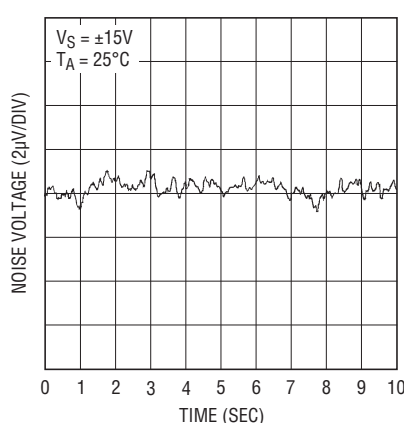

1167 G20

0.1Hz to 10Hz Noise Voltage, Referred to Input, G = 1000

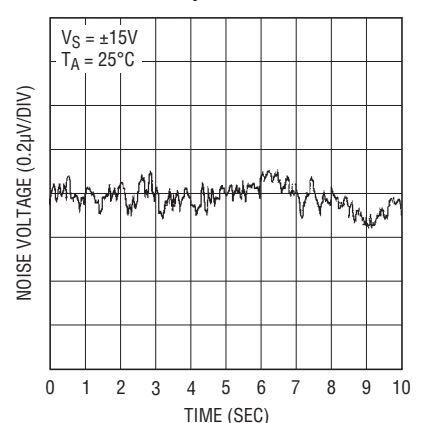

1167 G21

TYPICAL PERFORMANCE CHARACTERISTICS

Current Noise Density vs Frequency

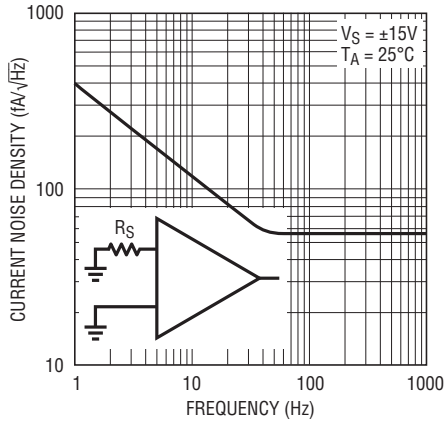

1167 G22

0.1Hz to 10Hz Current Noise

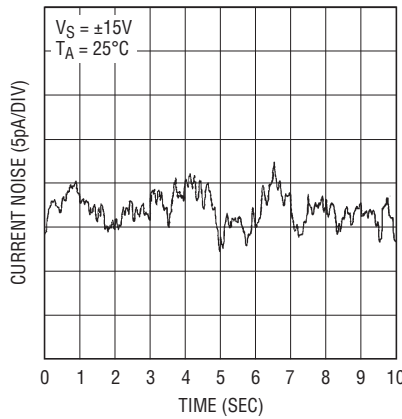

1167 G23

Short-Circuit Current vs Time



1167 G24

Overshoot vs Capacitive Load

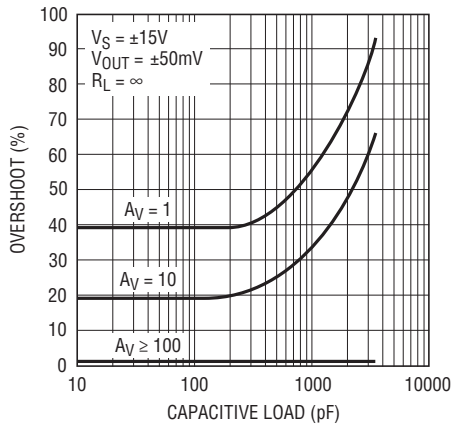

1167 G25

Large-Signal Transient Response

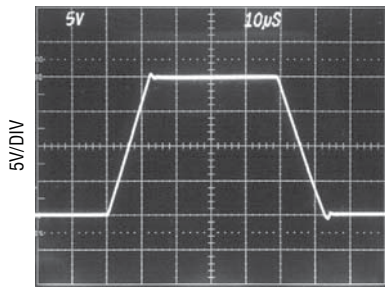

1167 G28

$G = 1$
 $V_S = \pm 15V$
 $R_L = 2k$
 $C_L = 60pF$

Small-Signal Transient Response

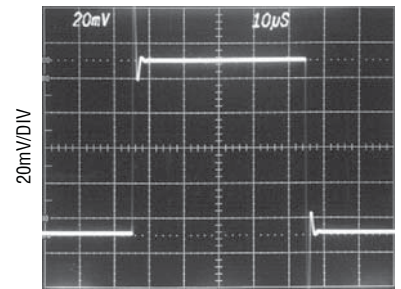

1167 G29

$G = 1$
 $V_S = \pm 15V$
 $R_L = 2k$
 $C_L = 60pF$

Output Impedance vs Frequency

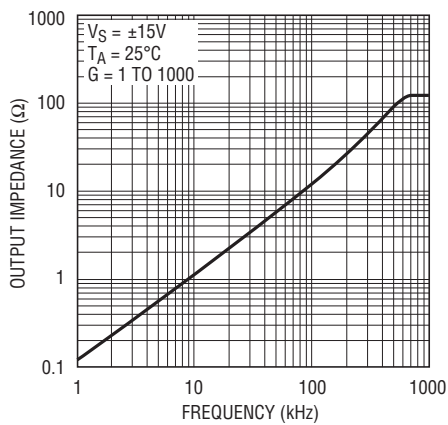

1167 G26

Large-Signal Transient Response

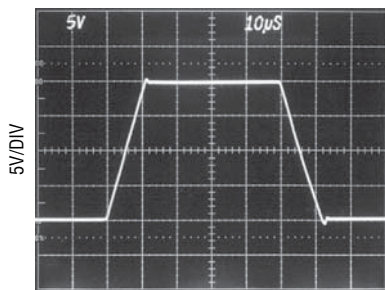

1167 G31

$G = 1$
 $V_S = \pm 15V$
 $R_L = 2k$
 $C_L = 60pF$

Small-Signal Transient Response

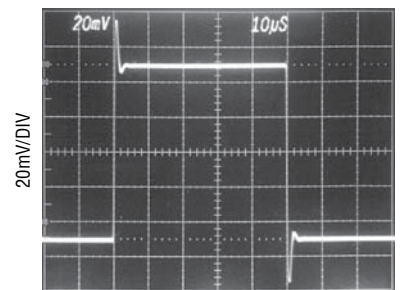

1167 G32

$G = 10$
 $V_S = \pm 15V$
 $R_L = 2k$
 $C_L = 60pF$

TYPICAL PERFORMANCE CHARACTERISTICS

Undistorted Output Swing vs Frequency



Large-Signal Transient Response

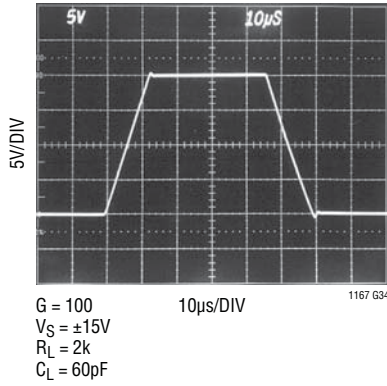

Small-Signal Transient Response

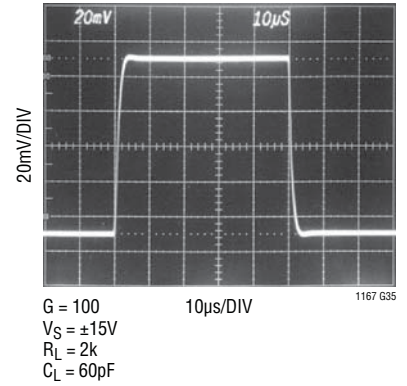

Settling Time vs Gain

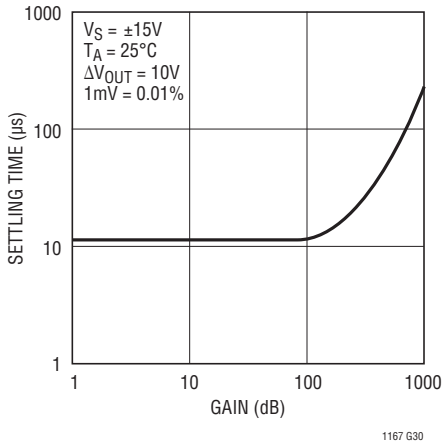

Large-Signal Transient Response

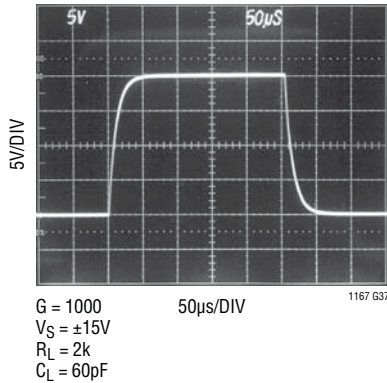

Small-Signal Transient Response

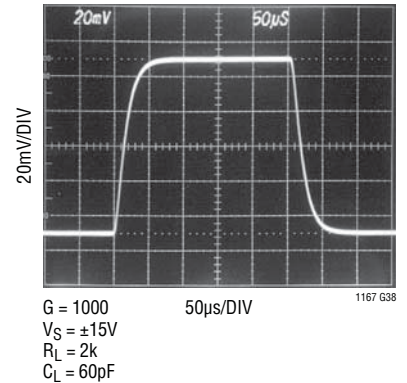

Settling Time vs Step Size

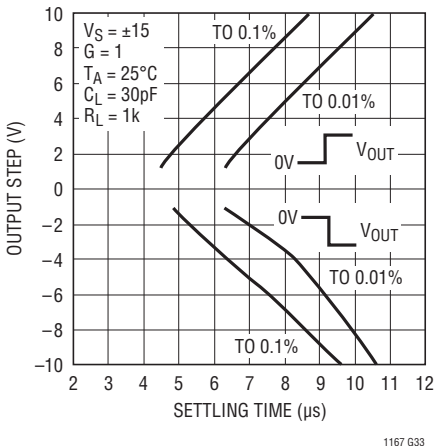

Slew Rate vs Temperature

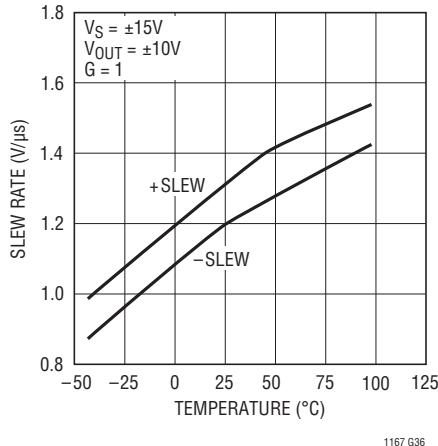

Output Voltage Swing vs Load Current

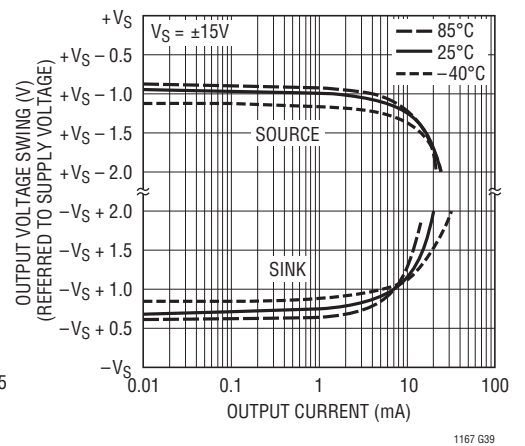

BLOCK DIAGRAM

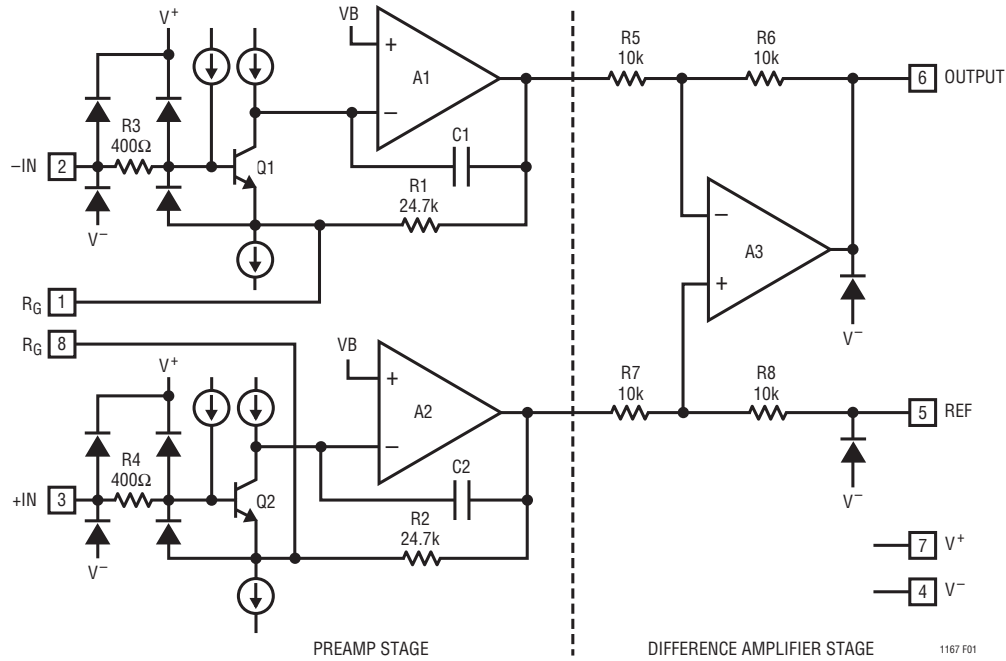

Figure 1. Block Diagram

THEORY OF OPERATION

The LT1167 is a modified version of the three op amp instrumentation amplifier. Laser trimming and monolithic construction allow tight matching and tracking of circuit parameters over the specified temperature range. Refer to the block diagram (Figure 1) to understand the following circuit description. The collector currents in Q1 and Q2 are trimmed to minimize offset voltage drift, thus assuring a high level of performance. R1 and R2 are trimmed to an absolute value of 24.7k to assure that the gain can be set accurately (0.05% at $G = 100$) with only one external resistor R_G . The value of R_G determines the transconductance of the preamp stage. As R_G is reduced for larger programmed gains, the transconductance of the input preamp stage increases to that of the input transistors Q1 and Q2. This increases the open-loop gain when the programmed gain is increased, reducing the input referred gain related errors and noise. The input voltage noise at gains greater than 50 is determined only by Q1 and Q2. At lower gains the noise of the difference amplifier and preamp gain setting resistors increase the noise. The gain bandwidth product is determined by C1, C2 and the preamp transconductance which increases

with programmed gain. Therefore, the bandwidth does not drop proportionally to gain.

The input transistors Q1 and Q2 offer excellent matching, which is inherent in NPN bipolar transistors, as well as picoampere input bias current due to superbeta processing. The collector currents in Q1 and Q2 are held constant due to the feedback through the Q1-A1-R1 loop and Q2-A2-R2 loop which in turn impresses the differential input voltage across the external gain set resistor R_G . Since the current that flows through R_G also flows through R1 and R2, the ratios provide a gained-up differential voltage, $G = (R1 + R2)/R_G$, to the unity-gain difference amplifier A3. The common mode voltage is removed by A3, resulting in a single-ended output voltage referenced to the voltage on the REF pin. The resulting gain equation is:

$$V_{OUT} - V_{REF} = G(V_{IN}^+ - V_{IN}^-)$$

where:

$$G = (49.4k\Omega/R_G) + 1$$

solving for the gain set resistor gives:

$$R_G = 49.4k\Omega/(G - 1)$$

THEORY OF OPERATION



Figure 3. Providing an Input Common Mode Current Path

APPLICATIONS INFORMATION

The LT1167 is a low power precision instrumentation amplifier that requires only one external resistor to accurately set the gain anywhere from 1 to 1000. The output can handle capacitive loads up to 1000pF in any gain configuration and the inputs are protected against ESD strikes up to 13kV (human body).

Input Current at High Common Mode Voltage

When operating within the specified input common mode range, both the LT1167 and LT1167-1 operate as shown in the Input Bias Current vs Common Mode Input Voltage graph shown in the Typical Performance Characteristics. If however the inputs are within approximately 0.8V of the positive supply, the LT1167 input current will increase to approximately $-1\mu\text{A}$ to $-3\mu\text{A}$. If the impedance of the circuit driving the LT1167 inputs is sufficiently high (e.g., $10\text{M}\Omega$ when $+V_S = 15\text{V}$), this increased input current can pull the input voltage sufficiently high to keep the elevated input current flowing. The LT1167-1 has been modified so that the input current is typically two orders of magnitude lower under similar conditions. The LT1167-1 is recommended for new designs where input impedance is high.

Input Protection

The LT1167 can safely handle up to $\pm 20\text{mA}$ of input current in an overload condition. Adding an external 5k input resistor in series with each input allows DC input fault voltages up to $\pm 100\text{V}$ and improves the ESD immunity to 8kV (contact) and 15kV (air discharge), which is the IEC 1000-4-2 level 4 specification. If lower value input

resistors are needed, a clamp diode from the positive supply to each input will maintain the IEC 1000-4-2 specification to level 4 for both air and contact discharge. A 2N4393 drain/source to gate is a good low leakage diode for use with 1k resistors, see Figure 4. The input resistors should be carbon and not metal film or carbon film.

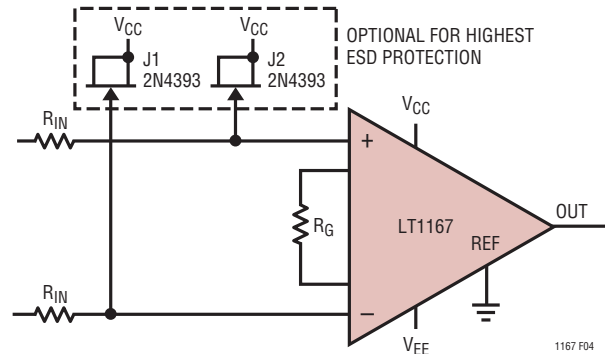

Figure 4. Input Protection

RFI Reduction

In many industrial and data acquisition applications, instrumentation amplifiers are used to accurately amplify small signals in the presence of large common mode voltages or high levels of noise. Typically, the sources of these very small signals (on the order of microvolts or millivolts) are sensors that can be a significant distance from the signal conditioning circuit. Although these sensors may be connected to signal conditioning circuitry, using shielded or unshielded twisted-pair cabling, the cabling may act as antennae, conveying very high frequency interference directly into the input stage of the LT1167.

APPLICATIONS INFORMATION

The amplitude and frequency of the interference can have an adverse effect on an instrumentation amplifier's input stage by causing an unwanted DC shift in the amplifier's input offset voltage. This well known effect is called RFI rectification and is produced when out-of-band interference is coupled (inductively, capacitively or via radiation) and rectified by the instrumentation amplifier's input transistors. These transistors act as high frequency signal detectors, in the same way diodes were used as RF envelope detectors in early radio designs. Regardless of the type of interference or the method by which it is coupled into the circuit, an out-of-band error signal appears in series with the instrumentation amplifier's inputs.

To significantly reduce the effect of these out-of-band signals on the input offset voltage of instrumentation amplifiers, simple lowpass filters can be used at the inputs. These filters should be located very close to the input pins of the circuit. An effective filter configuration is illustrated in Figure 5, where three capacitors have been added to the inputs of the LT1167. Capacitors C_{XCM1} and C_{XCM2} form lowpass filters with the external series resistors $R_{S1,2}$ to any out-of-band signal appearing on each of the input traces. Capacitor C_{XD} forms a filter to reduce any unwanted signal that would appear across the input traces. An added benefit to using C_{XD} is that the circuit's AC common mode rejection is not degraded due to common mode capacitive



Figure 5. Adding a Simple RC Filter at the Inputs to an Instrumentation Amplifier Is Effective in Reducing Rectification of High Frequency Out-of-Band Signals

imbalance. The differential mode and common mode time constants associated with the capacitors are:

$$t_{DM(LPF)} = (2)(R_S)(C_{XD})$$

$$t_{CM(LPF)} = (R_{S1,2})(C_{XCM1,2})$$

Setting the time constants requires a knowledge of the frequency, or frequencies of the interference. Once this frequency is known, the common mode time constants can be set followed by the differential mode time constant. To avoid any possibility of inadvertently affecting the signal to be processed, set the common mode time constant an order of magnitude (or more) larger than the differential mode time constant. Set the common mode time constants such that they do not degrade the LT1167's inherent AC CMR. Then the differential mode time constant can be set for the bandwidth required for the application. Setting the differential mode time constant close to the sensor's BW also minimizes any noise pickup along the leads. To avoid any possibility of common mode to differential mode signal conversion, match the common mode time constants to 1% or better. If the sensor is an RTD or a resistive strain gauge, then the series resistors $R_{S1,2}$ can be omitted, if the sensor is in proximity to the instrumentation amplifier.

“Roll Your Own”—Discrete vs Monolithic LT1167 Error Budget Analysis

The LT1167 offers performance superior to that of “roll your own” three op amp discrete designs. A typical application that amplifies and buffers a bridge transducer's differential output is shown in Figure 6. The amplifier, with its gain set to 100, amplifies a differential, full-scale output voltage of 20mV over the industrial temperature range. To make the comparison challenging, the low cost version of the LT1167 will be compared to a discrete instrumentation amp made with the A grade of one of the best precision quad op amps, the LT1114A. The LT1167C outperforms the discrete amplifier that has lower V_{OS} , lower I_B and comparable V_{OS} drift. The error budget comparison in Table 1 shows how various errors are calculated and how each error affects the total error budget. The table shows the greatest differences between the discrete solution and

APPLICATIONS INFORMATION



Figure 6. “Roll Your Own” vs LT1167

Table 1. “Roll Your Own” vs LT1167 Error Budget

| ERROR SOURCE | LT1167C CIRCUIT CALCULATION | “ROLL YOUR OWN” CIRCUIT CALCULATION | ERROR, ppm OF FULL SCALE | |
|---|--|---|--------------------------|-----------------|
| | | | LT1167C | “ROLL YOUR OWN” |
| Absolute Accuracy at $T_A = 25^\circ\text{C}$ | | | | |
| Input Offset Voltage, μV | 60 $\mu\text{V}/20\text{mV}$ | 100 $\mu\text{V}/20\text{mV}$ | 3000 | 5000 |
| Output Offset Voltage, μV | (300 $\mu\text{V}/100)/20\text{mV}$ | [(60 $\mu\text{V})(2)/100]/20\text{mV}$ | 150 | 60 |
| Input Offset Current, nA | [(450pA)(350/2) Ω]/20mV | [(450pA)(350 Ω)/2]/20mV | 4 | 4 |
| CMR, dB | 110dB \rightarrow [(3.16ppm)(5V)]/20mV | [(0.02% Match)(5V)]/20mV | 790 | 500 |
| Total Absolute Error | | | 3944 | 5564 |
| Drift to 85°C | | | | |
| Gain Drift, ppm/°C | (50ppm + 10ppm)(60°C) | (100ppm/°C Track)(60°C) | 3600 | 6000 |
| Input Offset Voltage Drift, $\mu\text{V}/^\circ\text{C}$ | [(0.4 $\mu\text{V}/^\circ\text{C})(60^\circ\text{C})]/20\text{mV}$ | [(1.6 $\mu\text{V}/^\circ\text{C})(60^\circ\text{C})]/20\text{mV}$ | 1200 | 4800 |
| Output Offset Voltage Drift, $\mu\text{V}/^\circ\text{C}$ | [(6 $\mu\text{V}/^\circ\text{C})(60^\circ\text{C})]/100/20\text{mV}$ | [(1.1 $\mu\text{V}/^\circ\text{C})(2)(60^\circ\text{C})]/100/20\text{mV}$ | 180 | 66 |
| Total Drift Error | | | 4980 | 10866 |
| Resolution | | | | |
| Gain Nonlinearity, ppm of Full Scale | 15ppm | 10ppm | 15 | 10 |
| Typ 0.1Hz to 10Hz Voltage Noise, μV_{P-P} | 0.28 $\mu\text{V}_{P-P}/20\text{mV}$ | (0.3 $\mu\text{V}_{P-P})(\sqrt{2})/20\text{mV}$ | 14 | 21 |
| Total Resolution Error | | | 29 | 31 |
| Grand Total Error | | | 8953 | 16461 |

$G = 100$, $V_S = \pm 15\text{V}$
 All errors are min/max and referred to input.

the LT1167 are input offset voltage and CMRR. Note that for the discrete solution, the noise voltage specification is multiplied by $\sqrt{2}$ which is the RMS sum of the uncorelated noise of the two input amplifiers. Each of the amplifier errors is referenced to a full-scale bridge differential voltage of 20mV. The common mode range of the bridge is 5V. The LT1114 data sheet provides offset voltage, offset voltage drift and offset current specifications for the matched op amp pairs used in the error-budget table. Even with an excellent matched op amp like the LT1114, the discrete solution’s total error is significantly higher than the LT1167’s

total error. The LT1167 has additional advantages over the discrete design, including lower component cost and smaller size.

Current Source

Figure 7 shows a simple, accurate, low power programmable current source. The differential voltage across Pins 2 and 3 is mirrored across R_G . The voltage across R_G is amplified and applied across R_X , defining the output current. The 50 μA bias current flowing from Pin 5 is buffered by the LT1464 JFET operational amplifier. This

APPLICATIONS INFORMATION

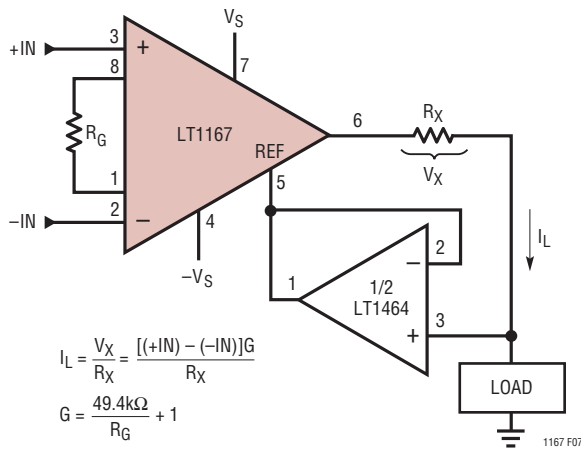

Figure 7. Precision Voltage-to-Current Converter

has the effect of improving the resolution of the current source to 3pA, which is the maximum I_B of the LT1464A. Replacing R_G with a programmable resistor greatly increases the range of available output currents.

Nerve Impulse Amplifier

The LT1167's low current noise makes it ideal for high source impedance EMG monitors. Demonstrating the LT1167's ability to amplify low level signals, the circuit in Figure 8 takes advantage of the amplifier's high gain and low noise operation. This circuit amplifies the low level nerve impulse signals received from a patient at Pins 2 and 3. R_G and the parallel combination of R_3 and R_4 set a gain of ten. The potential on LT1112's Pin 1 creates a ground for the common mode signal. C_1 was chosen to maintain the stability of the patient ground. The LT1167's

high CMRR ensures that the desired differential signal is amplified and unwanted common mode signals are attenuated. Since the DC portion of the signal is not important, R_6 and C_2 make up a 0.3Hz highpass filter. The AC signal at LT1112's Pin 5 is amplified by a gain of 101 set by $(R_7/R_8) + 1$. The parallel combination of C_3 and R_7 form a lowpass filter that decreases this gain at frequencies above 1kHz. The ability to operate at $\pm 3V$ on 0.9mA of supply current makes the LT1167 ideal for battery-powered applications. Total supply current for this application is 1.7mA. Proper safeguards, such as isolation, must be added to this circuit to protect the patient from possible harm.

Low I_B Favors High Impedance Bridges, Lowers Dissipation

The LT1167's low supply current, low supply voltage operation and low input bias currents optimize it for battery-powered applications. Low overall power dissipation necessitates using higher impedance bridges. The single supply pressure monitor application (Figure 9) shows the LT1167 connected to the differential output of a 3.5k bridge. The bridge's impedance is almost an order of magnitude higher than that of the bridge used in the error-budget table. The picoampere input bias currents keep the error caused by offset current to a negligible level. The LT1112 level shifts the LT1167's reference pin and the ADC's analog ground pins above ground. The LT1167's and LT1112's combined power dissipation is still less than the bridge's. This circuit's total supply current is just 2.8mA.

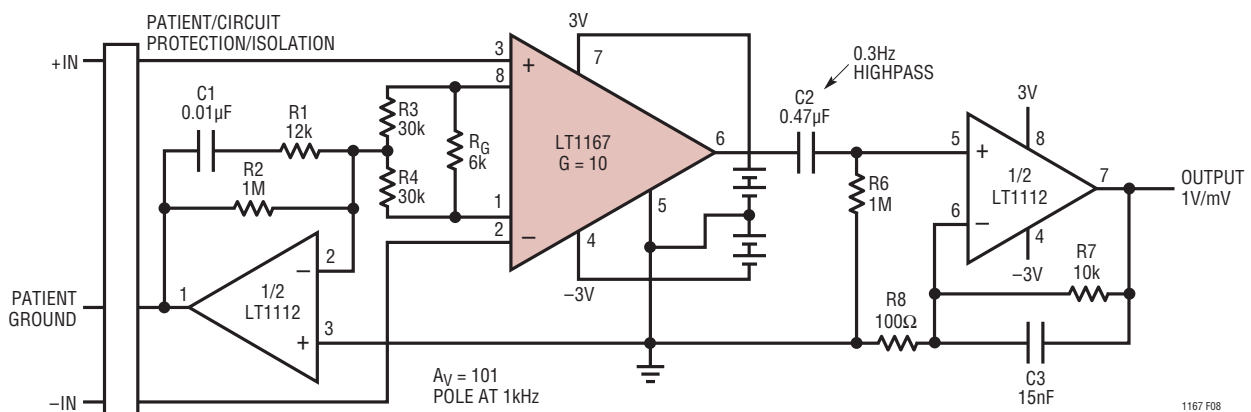

Figure 8. Nerve Impulse Amplifier

APPLICATIONS INFORMATION



Figure 9. Single Supply Bridge Amplifier

TYPICAL APPLICATION

AC Coupled Instrumentation Amplifier



PACKAGE DESCRIPTION

Please refer to <http://www.linear.com/designtools/packaging/> for the most recent package drawings.

N8 Package
8-Lead PDIP (Narrow .300 Inch)
 (Reference LTC DWG # 05-08-1510 Rev I)



NOTE:
 1. DIMENSIONS ARE $\frac{\text{INCHES}}{\text{MILLIMETERS}}$
 *THESE DIMENSIONS DO NOT INCLUDE MOLD FLASH OR PROTRUSIONS.
 MOLD FLASH OR PROTRUSIONS SHALL NOT EXCEED .010 INCH (0.254mm)

PACKAGE DESCRIPTION

Please refer to <http://www.linear.com/designtools/packaging/> for the most recent package drawings.

S8 Package 8-Lead Plastic Small Outline (Narrow .150 Inch) (Reference LTC DWG # 05-08-1610)



- NOTE:
 1. DIMENSIONS IN $\frac{\text{INCHES}}{\text{MILLIMETERS}}$
 2. DRAWING NOT TO SCALE
 3. THESE DIMENSIONS DO NOT INCLUDE MOLD FLASH OR PROTRUSIONS.
 MOLD FLASH OR PROTRUSIONS SHALL NOT EXCEED $.006$ " (0.15mm)

S08 0303

REVISION HISTORY (Revision history begins at Rev B)

| REV | DATE | DESCRIPTION | PAGE NUMBER |
|-----|-------|---|-------------|
| B | 01/11 | Added LT1167-1 to Description, Absolute Maximum Ratings, Order Information, Electrical Characteristics and Applications Information Section | 1-6, 15 |
| C | 08/11 | Correction to TYP specification for SR from 12 to 1.2 Columns shifted to left in CMRR specification | 4 4, 5 |

TYPICAL APPLICATION

4-Digit Pressure Sensor

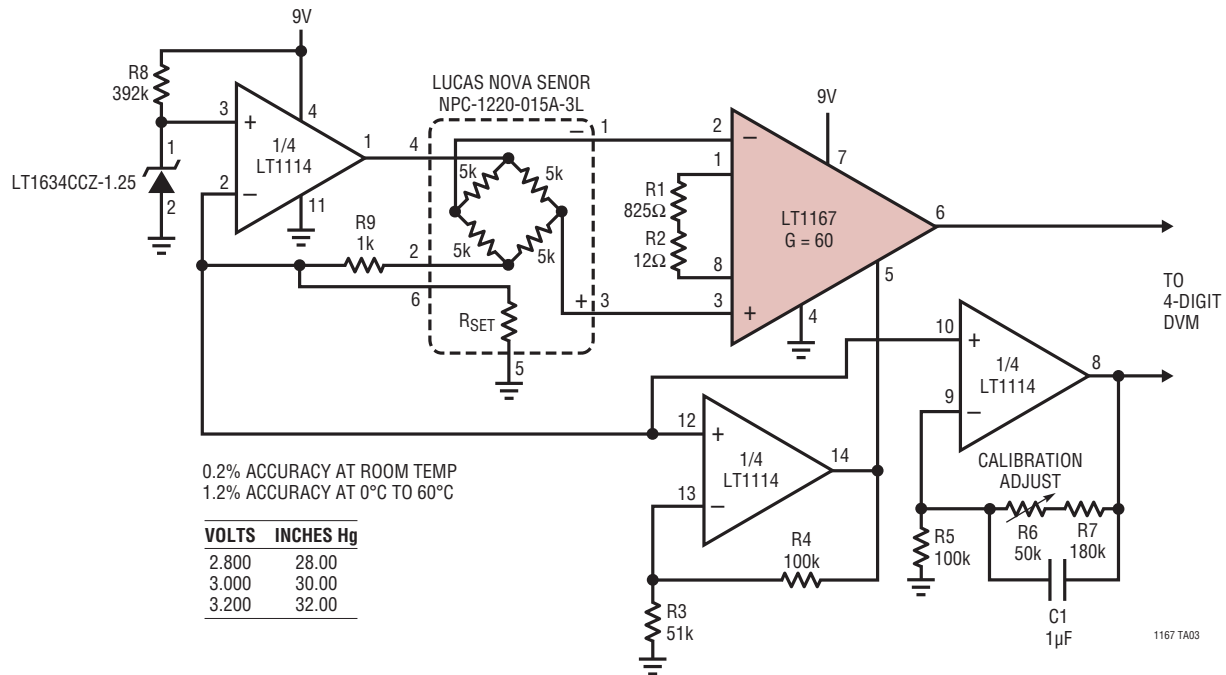

RELATED PARTS

| PART NUMBER | DESCRIPTION | COMMENTS |
|-------------|---|--|
| LTC1100 | Precision Chopper-Stabilized Instrumentation Amplifier | Best DC Accuracy |
| LT1101 | Precision, Micropower, Single Supply Instrumentation Amplifier | Fixed Gain of 10 or 100, $I_S < 105\mu A$ |
| LT1102 | High Speed, JFET Instrumentation Amplifier | Fixed Gain of 10 or 100, 30V/ μs Slew Rate |
| LT1168 | Low Power, Single Resistor Programmable Instrumentation Amplifier | $I_{SUPPLY} = 530\mu A$ Max |
| LTC1418 | 14-Bit, Low Power, 200ksps ADC with Serial and Parallel I/O | Single Supply 5V or $\pm 5V$ Operation, $\pm 1.5LSB$ INL and $\pm 1LSB$ DNL Max |
| LT1460 | Precision Series Reference | Micropower; 2.5V, 5V, 10V Versions; High Precision |
| LT1468 | 16-Bit Accurate Op Amp, Low Noise Fast Settling | 16-Bit Accuracy at Low and High Frequencies, 90MHz GBW, 22V/ μs , 900ns Settling |
| LTC1562 | Active RC Filter | Lowpass, Bandpass, Highpass Responses; Low Noise, Low Distortion, Four 2nd Order Filter Sections |
| LTC1605 | 16-Bit, 100ksps, Sampling ADC | Single 5V Supply, Bipolar Input Range: $\pm 10V$, Power Dissipation: 55mW Typ |



Компания «ЭлектроПласт» предлагает заключение долгосрочных отношений при поставках импортных электронных компонентов на взаимовыгодных условиях!

Наши преимущества:

- Оперативные поставки широкого спектра электронных компонентов отечественного и импортного производства напрямую от производителей и с крупнейших мировых складов;
- Поставка более 17-ти миллионов наименований электронных компонентов;
- Поставка сложных, дефицитных, либо снятых с производства позиций;
- Оперативные сроки поставки под заказ (от 5 рабочих дней);
- Экспресс доставка в любую точку России;
- Техническая поддержка проекта, помощь в подборе аналогов, поставка прототипов;
- Система менеджмента качества сертифицирована по Международному стандарту ISO 9001;
- Лицензия ФСБ на осуществление работ с использованием сведений, составляющих государственную тайну;
- Поставка специализированных компонентов (Xilinx, Altera, Analog Devices, Intersil, Interpoint, Microsemi, Aeroflex, Peregrine, Syfer, Eurofarad, Texas Instrument, Miteq, Cobham, E2V, MA-COM, Hittite, Mini-Circuits, General Dynamics и др.);

Помимо этого, одним из направлений компании «ЭлектроПласт» является направление «Источники питания». Мы предлагаем Вам помощь Конструкторского отдела:

- Подбор оптимального решения, техническое обоснование при выборе компонента;
- Подбор аналогов;
- Консультации по применению компонента;
- Поставка образцов и прототипов;
- Техническая поддержка проекта;
- Защита от снятия компонента с производства.



Как с нами связаться

Телефон: 8 (812) 309 58 32 (многоканальный)

Факс: 8 (812) 320-02-42

Электронная почта: org@eplast1.ru

Адрес: 198099, г. Санкт-Петербург, ул. Калинина, дом 2, корпус 4, литера А.