

SILENT RELAY FOR AUTOMOTIVE APPLICATIONS 1 POLE—25 A

FTR-P5 SERIES

RoHS compliant

■ FEATURES

- Low operating sound
An original silent mechanism decreases the propagation of operating sound when mounted on a PCB. (Average sound pressure: 50dB at 5 cm).
- Compact, high density package
198 mm² mounting area. (46% less than the FTR-P1 series quiet relay).
- High sensitivity, low power consumption
(nominal power consumption: 450 mW).
- High capacity
Heat dissipation is high due to a single cover structure.
- Ease of PCB layout
All terminals are on the perimeter.
- High breaking capability.
In addition to the standard gap product (0.3 mm), a higher gap product (0.6 mm), suitable for over voltage breaking can be supplied.
- Typical applications:
Wiper / IWW, Power window, Doorlock, Power seat
Sunroof, Interior lighting, Fan
- RoHS compliant since date code: 0623
Please see page 8 for more information

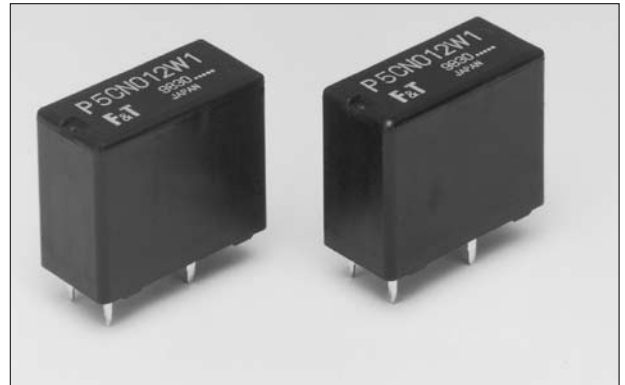

■ ORDERING INFORMATION

[Example] FTR-P5 C N 012 W1 **
 (a) (b) (c) (d) (e) (f)

(a)	Series Name	FTR-P2 : FTR-P2 Series		
(b)	Contact Arrangement	C : 1 Form C		
(c)	Contact Gap	N : 0.3 mm gap		
(d)	Nominal Voltage	009: 9 VDC	010: 10 VDC	012: 12 VDC
(e)	Contact Material	W1 : Silver-Tin-Oxide Indium Oxide		
(f)	Special product specification	Symbol to specify special specification product		

Note: The part number on the relay cover does not include 'FTR'

Example: Ordering part number: FTR-P5CN012W1
 Stamped part number: P5CN012W1

FTR-P5 SERIES

■ SPECIFICATIONS

Item		Specifications	
Contact	Arrangement	1 Form C	
	Material	Silver-tin oxide-indium	
	Voltage drop	100mV (1A, 12VDC)	
	Contact rating	14VDC, 25A (motor locked)	
	Maximum carrying current	25A / 1 hour (25°C, nominal voltage applied to coil)	
	Maximum switching current	35A, 16 VDC (reference)	
	Minimum load*	6V, 1A (reference)	
Coil	Operating temperature range	-40°C to +85°C (no frost)	
	Storage temperature range	-40°C to +100°C (no frost)	
Time	Operate (at nominal voltage)	10 ms maximum	
	Release (at nominal voltage)	5 ms maximum (without diode)	
Life	Mechanical	10 million operations minimum	
	Electrical	100k operations minimum (at contact rating)	
Other	Vibration resistance (operational)		10-55HZ, 1.5mm double amplitude
	Shock resistance	operational	100 m/s ² minimum (10G)
		no damage	100 m/s ² minimum (100G)
	Weight		Approximately 13 grams
Average sound pressure		Approximately 50dB at 5cm	

*This is the standard value of the minimum load level. This value may differ depending on the switching frequency, environmental conditions and target reliability standard. We recommend to check this value by an actual load prior to use.

■ COIL DATA

Product Name	Nominal Coil Voltage	Coil Resistance* (±10%)	Power Consumption at nominal coil voltage*	Must Operate Voltage*	Must Release Voltage
FTR-P5CN009W1	DC 9V	180Ω	450mW	5.5V (20°) 6.9V (85°)	0.72
FTR-P5CN010W1	DC 10V	220Ω	455mW	6.3V (20°) 7.9V(85°)	0.8
FTR-P5CN012W1	DC 12V	320Ω	450mW	7.3V (20°) 9.2V (85°)	0.96

FTR-P5 SERIES

CHARACTERISTIC DATA

1. MAXIMUM BREAK CAPACITY

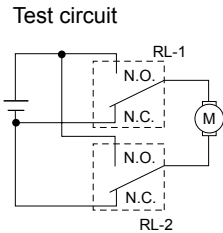
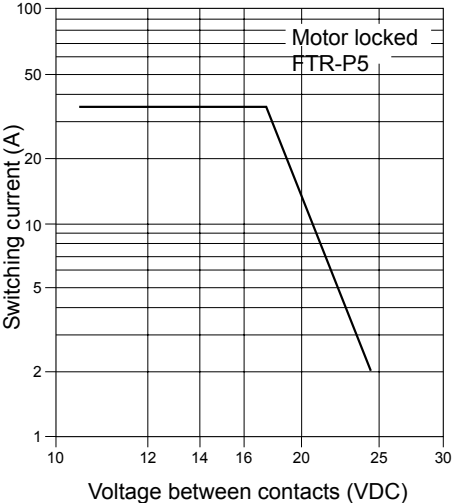

2. LIFE

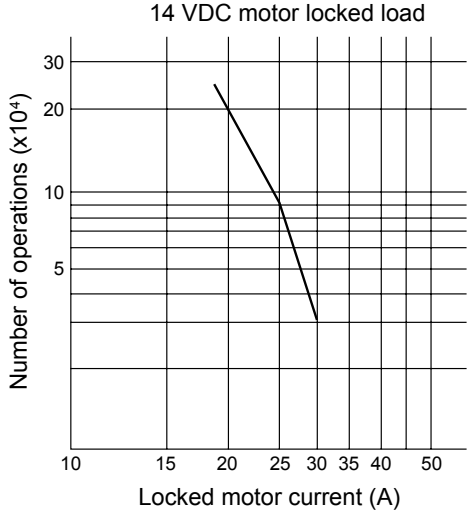

FTR-P5 SERIES

3. LIFE TEST (EXAMPLES)

- Test item
14 V DC,
inrush current: 30 A
motor free
300K operations minimum
0.25 seconds ON,
9.75 seconds OFF

• Test circuit

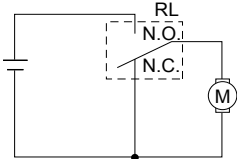

Note: NC contacts provide dynamic brake circuit

• Current wave form

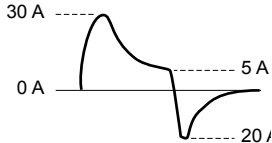

• Change in pick-up drop-out voltage

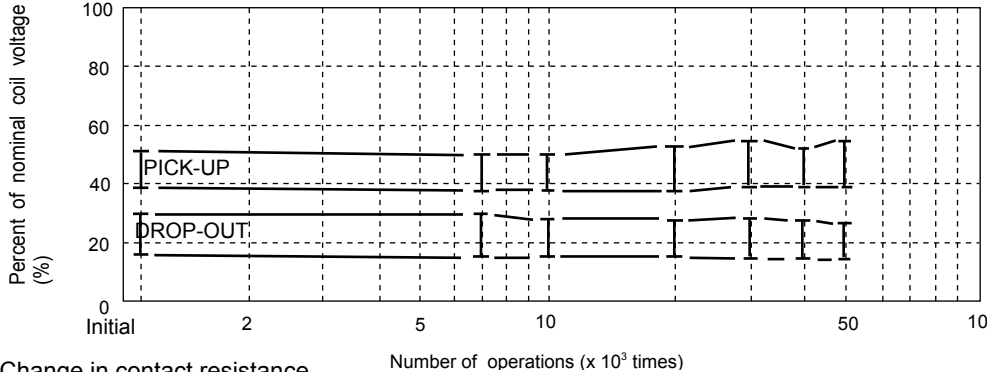

• Change in contact resistance

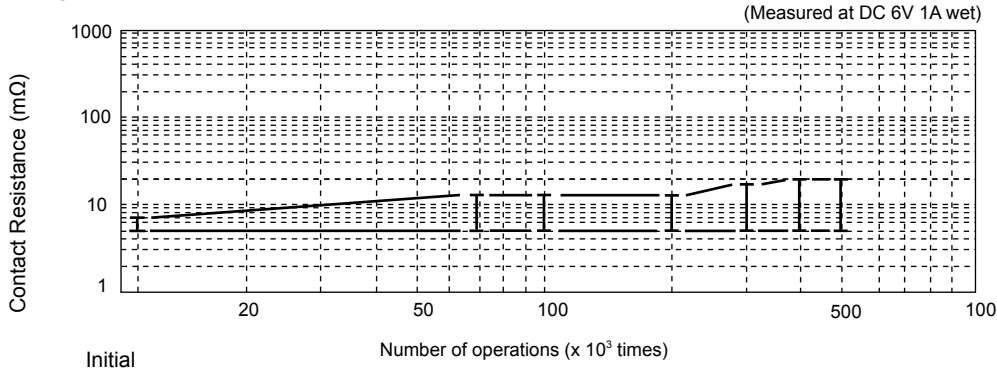

- Test item
14 V DC-25 A
Motor Lock
100K operations
minimum*

• Test circuit

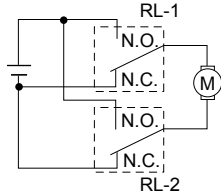

• Current wave form

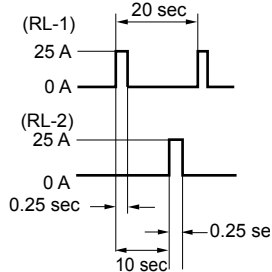

* 1 operation = 1 forward and 1 reverse

• Shift of pick-up drop-out voltage

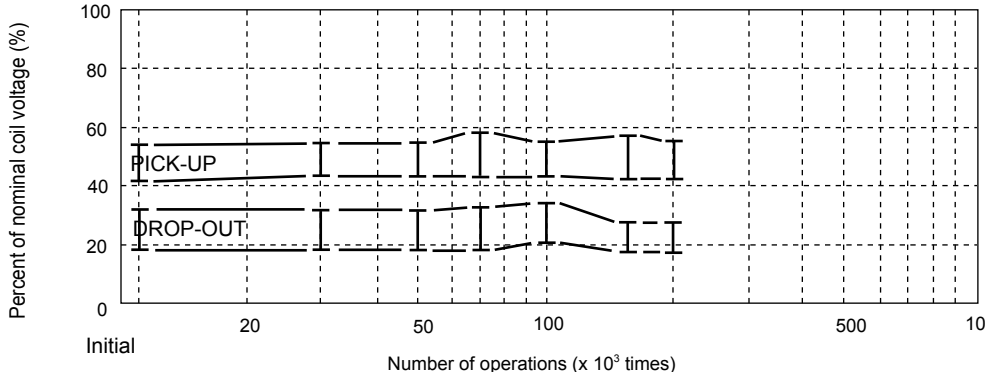

• Change in contact resistance

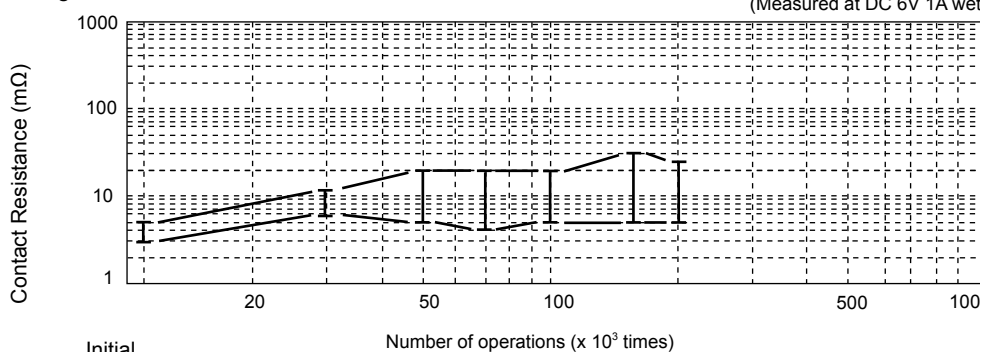

FTR-P5 SERIES

4. COIL TEMPERATURE RISE

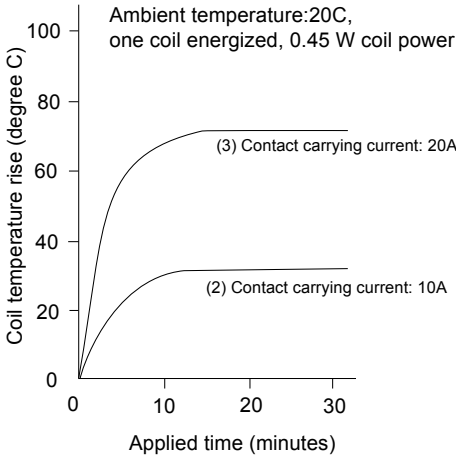

5. MAXIMUM BREAK CAPACITY

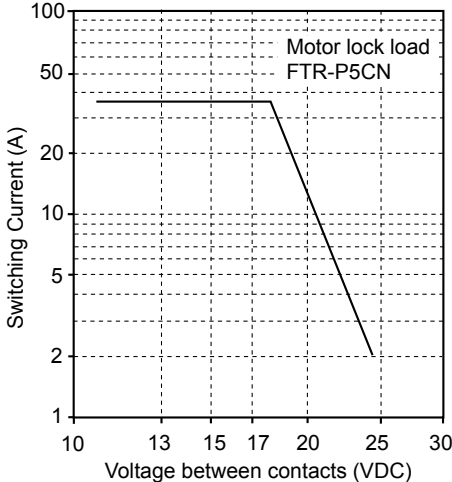

6. OPERATING COIL VOLTAGE RANGE

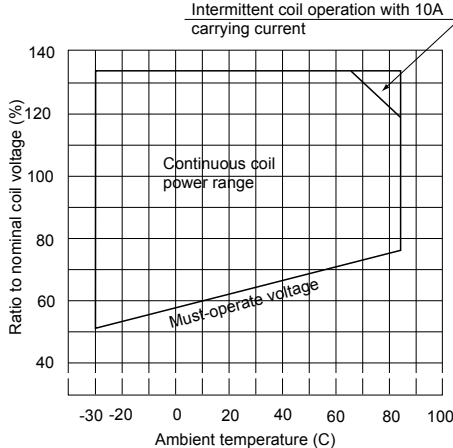

7. VIBRATION RESISTANCE CHARACTERISTICS

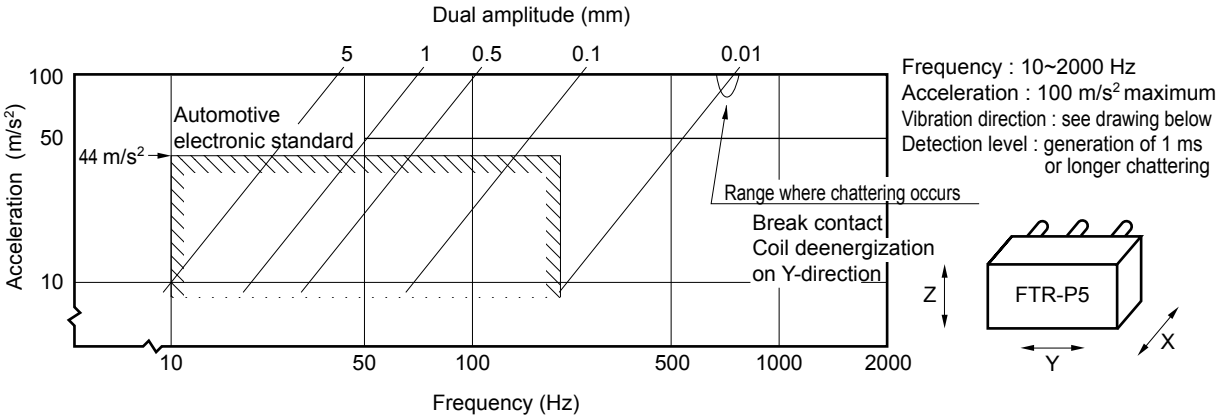

8. SHOCK RESISTANCE CHARACTERISTIC

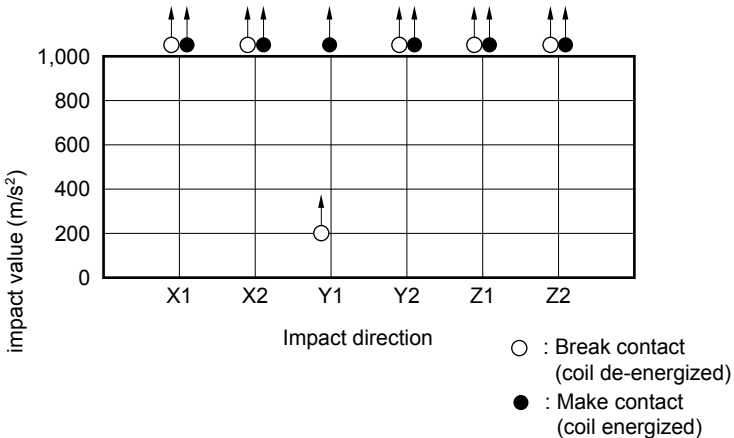

Impact apply time : 111 ms, half-sine wave
Test condition: coil, energized and de-energized
Impact direction : see drawing below
Detection level : generation of 1 ms or longer contact chattering

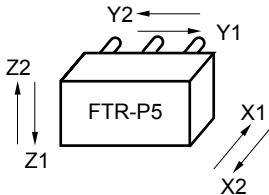

FTR-P5 SERIES

REFERENCE DATA

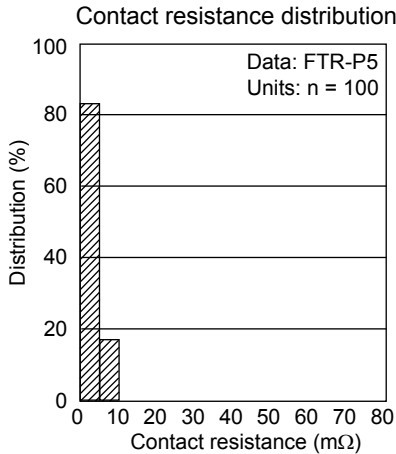
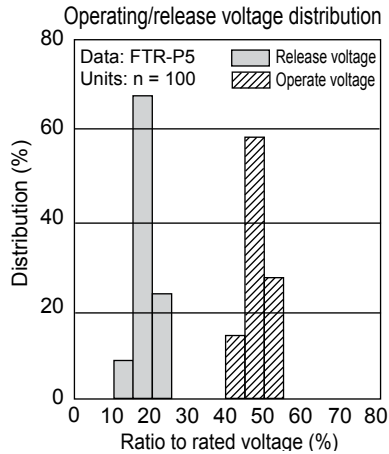
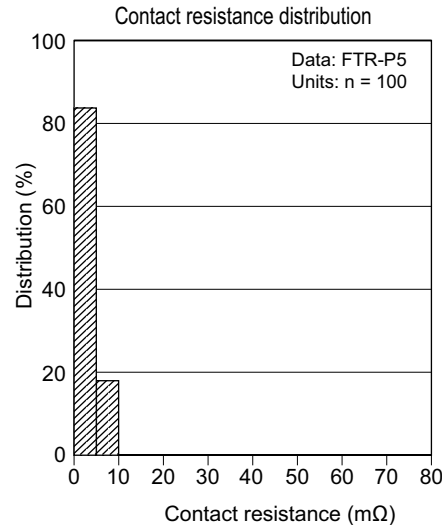
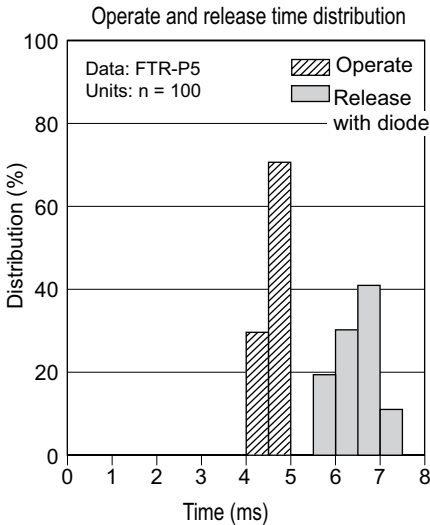
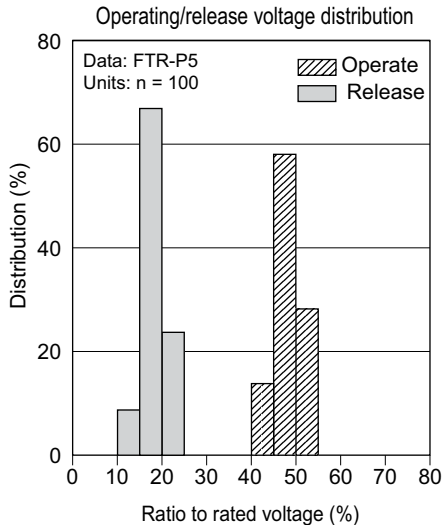

Distribution of sound pressure (with diode)

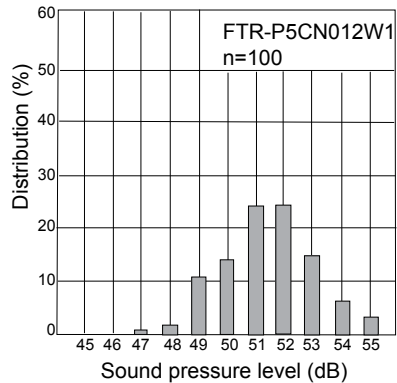

Method of acoustic noise measure
Measuring condition: Distance from 5 cm,
relay operation at 10Hz
Tester: Noise tester Ryon NA-61, A range

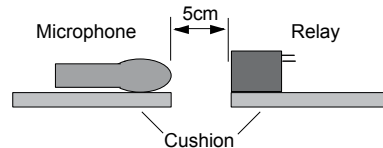

DIMENSIONS

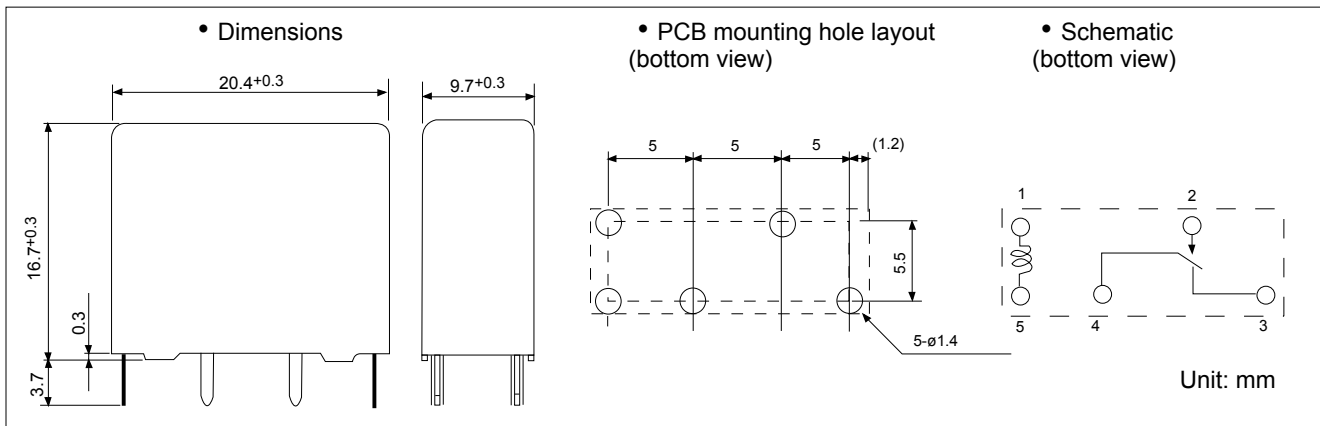

RoHS Compliance and Lead Free Relay Information

1. General Information

- Relays produced after the specific date code that is indicated on each data sheet are lead-free now. Most of our signal and power relays are lead-free. Please refer to Lead-Free Status Info. (<http://www.fujitsu.com/us/downloads/MICRO/fcai/relays/lead-free-letter.pdf>)
- Lead free solder paste currently used in relays is Sn-3.0Ag-0.5Cu.
- All signal and most power relays also comply with RoHS. Please refer to individual data sheets. Relays that are RoHS compliant do not contain the 5 hazardous materials that are restricted by RoHS directive (lead, mercury, chromium IV, PBB, PBDE).
- It has been verified that using lead-free relays in leaded assembly process will not cause any problems (compatible).
- "LF" is marked on each outer and inner carton. (No marking on individual relays).
- To avoid leaded relays (for lead-free sample, etc.) please consult with area sales office.
- We will ship leaded relays as long as the leaded relay inventory exists.

Note: Cadmium was exempted from RoHS on October 21, 2005. (Amendment to Directive 2002/95/EC)

2. Recommended Lead Free Solder Profile

- Recommended solder paste Sn-3.0Ag-0.5Cu.

Reflow Solder condition

Flow Solder condition:

Pre-heating: maximum 120°C
Soldering: dip within 5 sec. at
260°C solder bath

Solder by Soldering Iron:

Soldering Iron
Temperature: maximum 360°C
Duration: maximum 3 sec.

We highly recommend that you confirm your actual solder conditions

3. Moisture Sensitivity

- Moisture Sensitivity Level standard is not applicable to electromechanical relays.

4. Tin Whisker

- Dipped SnAgCu solder is known as low risk tin whisker. No considerable length whisker was found by our in house test.

FTR-P5 SERIES

Fujitsu Components International Headquarter Offices

Japan

Fujitsu Component Limited
Gotanda-Chuo Building
3-5, Higashigotanda 2-chome, Shinagawa-ku
Tokyo 141 8630, Japan
Tel: (81-3) 5449-7010
Fax: (81-3) 5449-2626
Email: promothq@fcl.fujitsu.com
Web: www.fcl.fujitsu.com

North and South America

Fujitsu Components America, Inc.
250 E. Caribbean Drive
Sunnyvale, CA 94089 U.S.A.
Tel: (1-408) 745-4900
Fax: (1-408) 745-4970
Email: components@us.fujitsu.com
Web: <http://www.fujitsu.com/us/services/edevices/components/>

Europe

Fujitsu Components Europe B.V.
Diamantlaan 25
2132 WV Hoofddorp
Netherlands
Tel: (31-23) 5560910
Fax: (31-23) 5560950
Email: info@fceu.fujitsu.com
Web: emea.fujitsu.com/components/

Asia Pacific

Fujitsu Components Asia Ltd.
102E Pasir Panjang Road
#01-01 Citilink Warehouse Complex
Singapore 118529
Tel: (65) 6375-8560
Fax: (65) 6273-3021
Email: fcal@fcal.fujitsu.com
Web: <http://www.fujitsu.com/sg/services/micro/components/>

©2008 Fujitsu Components America, Inc. All rights reserved. All trademarks or registered trademarks are the property of their respective owners.

Fujitsu Components America or its affiliates do not warrant that the content of datasheet is error free. In a continuing effort to improve our products Fujitsu Components America, Inc. or its affiliates reserve the right to change specifications/datasheets without prior notice.
Rev. January 3, 2008.



Компания «ЭлектроПласт» предлагает заключение долгосрочных отношений при поставках импортных электронных компонентов на взаимовыгодных условиях!

Наши преимущества:

- Оперативные поставки широкого спектра электронных компонентов отечественного и импортного производства напрямую от производителей и с крупнейших мировых складов;
- Поставка более 17-ти миллионов наименований электронных компонентов;
- Поставка сложных, дефицитных, либо снятых с производства позиций;
- Оперативные сроки поставки под заказ (от 5 рабочих дней);
- Экспресс доставка в любую точку России;
- Техническая поддержка проекта, помощь в подборе аналогов, поставка прототипов;
- Система менеджмента качества сертифицирована по Международному стандарту ISO 9001;
- Лицензия ФСБ на осуществление работ с использованием сведений, составляющих государственную тайну;
- Поставка специализированных компонентов (Xilinx, Altera, Analog Devices, Intersil, Interpoint, Microsemi, Aeroflex, Peregrine, Syfer, Eurofarad, Texas Instrument, Miteq, Cobham, E2V, MA-COM, Hittite, Mini-Circuits, General Dynamics и др.);

Помимо этого, одним из направлений компании «ЭлектроПласт» является направление «Источники питания». Мы предлагаем Вам помощь Конструкторского отдела:

- Подбор оптимального решения, техническое обоснование при выборе компонента;
- Подбор аналогов;
- Консультации по применению компонента;
- Поставка образцов и прототипов;
- Техническая поддержка проекта;
- Защита от снятия компонента с производства.



Как с нами связаться

Телефон: 8 (812) 309 58 32 (многоканальный)

Факс: 8 (812) 320-02-42

Электронная почта: org@eplast1.ru

Адрес: 198099, г. Санкт-Петербург, ул. Калинина, дом 2, корпус 4, литера А.