

Surge Killer Unit 61F-03B/-04B

Protect 61F Controllers Against Lightning.

- A high-capacity protective device to protect against induced lightning damage.
- Used in locations that are susceptible to induced lightning damage, such as elevated water tanks and high-altitude locations.

 Refer to *Safety Precautions for Electrodes and Electrode Holders.*



Ordering Information

Item	Model
Three-pole Surge Killer Unit	61F-03B
Four-pole Surge Killer Unit	61F-04B

Specifications

Discharge start voltage	90 V ± 20 VDC
Impulse withstand voltage	200 kV (1 × 40 μs)
Impulse withstand current	6,000 A (1 × 40 μs)
Weight	Approx. 35 g

Connections

Mount the Surge Killer Unit as close to the Controller as possible. Adequate results may not be obtained if the Unit is mounted close to the Electrode Holder.

When grounding the Surge Killer Unit in the vicinity of the Controller, connect terminal 1 on the ground side of the Surge Killer Unit to the common electrode (the longest electrode.)

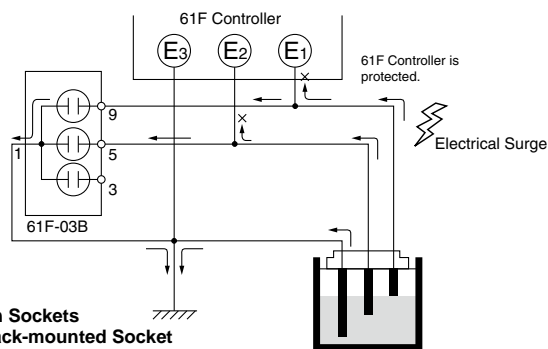

Connection Sockets
PF113A Track-mounted Socket
PL11 Back-connecting Socket

Internal Connections

61F-03B

Electrode connection terminals

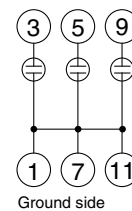

61F-04B

Electrode connection terminals

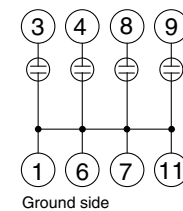

Dimensions

Note: All units are in millimeters unless otherwise indicated.

61F-03B
61F-04B

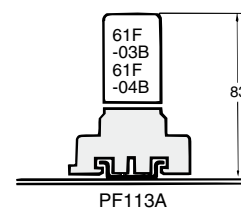
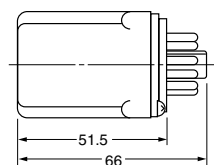
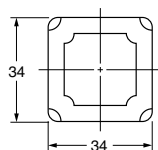

■ Safety Precautions

Refer to *Safety Precautions for All Level Controllers*.

ALL DIMENSIONS SHOWN ARE IN MILLIMETERS.

To convert millimeters into inches, multiply by 0.03937. To convert grams into ounces, multiply by 0.03527.

In the interest of product improvement, specifications are subject to change without notice.

Safety Precautions for Electrodes and Electrode Holders

⚠ WARNING

Do not touch the terminals while power is being supplied. Doing so may possibly result in electric shock.



Do not attempt to disassemble, repair, or modify the Controller while power is being supplied. Doing so may occasionally result in electric shock.



Precautions for Safe Use

Do not use the Controller in locations subject to explosive or combustible dust, combustible gas, flammable vapors, corrosive gas, excessive dust, salt-water spray, or water drops.

Electrode Precautions

Precautions for Correct Use

- Always disconnect the 61F when a tester to perform insulation resistance tests on the Electrode circuit.
- If the Electrodes are to be cut, bevel the cut surface.

● Be careful of the distances between Electrodes.

Allow a sufficient distance (normally 1 m) between Electrodes if they are used in seawater or sewage. Use a low-sensitivity 61F-□D(-□ND) Level Controller if sufficient distance cannot be obtained.

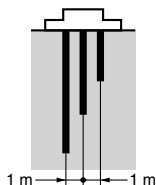

● Make the common (ground) Electrode longer.

For a group of three Electrodes consisting of a short, a medium, and a long Electrode, connect the shortest Electrode to E₁, the medium Electrode to E₂, and the long Electrode to E₃. The long Electrode (E₃) must be at least 50 mm longer than the other Electrodes.

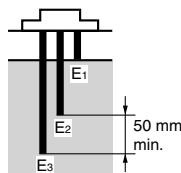

● Be careful of the operating level.

Changes in the type of liquid or the power supply voltage may cause the operating position to fluctuate somewhat even when the tip of the Electrode reaches the level of the liquid.

● Use separators.

When the required length of the Electrode is 1 m or more, use a Separator at each joint between two Electrodes to prevent the Electrodes from coming into contact each other in the water.

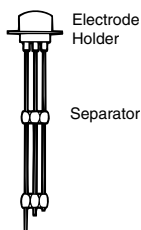

● Be careful of suspended matter causing Electrodes to come into contact with each other.

Use Tubing Electrodes if factors such as suspended matter cause Electrodes to come into contact with each other. To ensure conductivity, strip off at least 100 mm from the end of the Tubing and do not use Tubing on the common (earth) Electrode.

● Mount Electrodes vertically.

Water scum can easily accumulate on insulated parts and may cause insulation failure. Mount the Electrodes vertically.

● Electrodes must be cleaned.

- At about six months after installation, remove the Electrodes and use fine sandpaper to remove film from the surface. After that, clean the Electrodes once or twice a year. If the Electrodes are used in liquid with a lot of dirt or scum, insulating film may form, particularly on the surfaces of the Electrodes, and result in operating failures. Remove the insulating film once every three months or so. For sewage tanks, sewage, oil film, or other applications with a lot of waste material, use a pipe such as the one shown at the right.

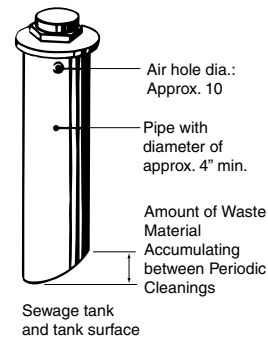

- Use a pipe with a diameter of at least four inches.
- Install the pipe with a diagonal cut at the end as shown in the figure at the right according to the estimated waste material accumulation.
- Provide an air ventilation hole with a diameter of approx. 10 mm on the upper part of the pipe.

● Breakwater Pipe Mounting Precautions

Install a breakwater pipe as shown in the figure at the right for applications with large waves or fast flow, such as for water purification.

- Use a pipe with a diameter of at least four inches.
- To improve the circulation of liquid inside the pipe, make at least four opposing holes with a diameter of 6 to 10 mm near the end of each electrode.
- Provide an air ventilation hole with a diameter of approx. 10 mm on the upper part of the pipe.

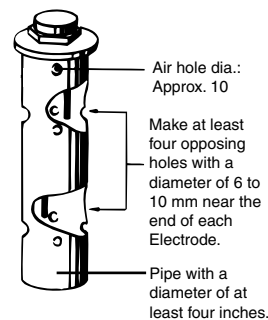

- The procedures above also apply to using Electrode bands.

■ Electrode Holder Precautions

Precautions for Correct Use

- Never mount the Electrode Holder horizontally. Mounting the Electrode Holder horizontally may cause liquid to leak from the Electrode Holder and result in 61F reset failure.

Precautions for Tightening Torque and Work

BS-1 (See note 1.)	Wire installation section (M4) (See note 3.)	137.2 N-cm
	Electrode Holder installation section (M18) (See note 2.)	6500.0 N-cm
BS-1T (See note 1.)	Wire installation section (M4) (See note 3.)	137.2 N-cm
	Electrode Holder installation section (M18) (See note 2.)	196.1 N-cm

- Note:**
1. A gasket is supplied with the BS-1. A gasket is not required to mount the BS-1T. (One is not supplied.)
 2. Wind commercially available sealing tape two or three times around the M18 screw section before tightening the screws.
 3. When installing the wiring, secure nut 2 with a wrench so that no force is applied to the terminal bolt, and complete the tightening with nut 1 (as in the following figure). If nut 2 is not secured, the load on the terminal bolt may cause leakage of steam and pressure.

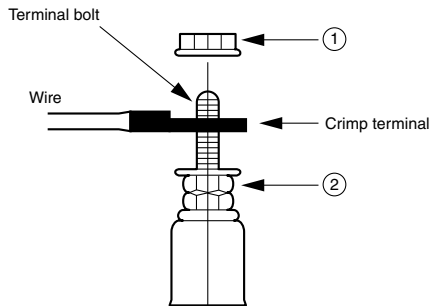

- Always use an F03-11 Protective Cover if the BF-3 (-4, -5) is used outdoors or in locations subject to water, dust, dirt, or other foreign matter. Foreign matter adhering to the electrode insulators may cause incorrect operation due to leaking.

ALL DIMENSIONS SHOWN ARE IN MILLIMETERS.

To convert millimeters into inches, multiply by 0.03937. To convert grams into ounces, multiply by 0.03527.

In the interest of product improvement, specifications are subject to change without notice.

Safety Precautions for All Level Controllers

Refer to the *Safety Precautions* section for each product for specific precautions applicable to that product.

WARNING

Do not touch the terminals while power is being supplied.
Doing so may possibly result in electric shock.

Do not attempt to disassemble, repair, or modify the product while power is being supplied. Doing so may occasionally result in electric shock.

■ Precautions for Safe Use

In order to ensure safe operation, be sure to observe the following points.

1. Use a power supply voltage within the specified range.
2. Do not use the Controller in locations subject to flammable gases or objects.
3. Insert the Socket until it securely clicks into place.
4. Do not short the load connected to the output terminals.
5. Do not connect the power supply in reverse.
6. Do not use the Controller in locations subject to explosive or combustible dust, combustible gas, flammable vapors, corrosive gas, excessive dust, salt water spray, or water drops.

■ Precautions for Correct Use

For details, refer to *Technical Guide for Level Controllers*.

In the interest of product improvement, specifications are subject to change without notice.

Read and Understand This Catalog

Please read and understand this catalog before purchasing the products. Please consult your OMRON representative if you have any questions or comments.

Warranty and Limitations of Liability

WARRANTY

OMRON's exclusive warranty is that the products are free from defects in materials and workmanship for a period of one year (or other period if specified) from date of sale by OMRON.

OMRON MAKES NO WARRANTY OR REPRESENTATION, EXPRESS OR IMPLIED, REGARDING NON-INFRINGEMENT, MERCHANTABILITY, OR FITNESS FOR PARTICULAR PURPOSE OF THE PRODUCTS. ANY BUYER OR USER ACKNOWLEDGES THAT THE BUYER OR USER ALONE HAS DETERMINED THAT THE PRODUCTS WILL SUITABLY MEET THE REQUIREMENTS OF THEIR INTENDED USE. OMRON DISCLAIMS ALL OTHER WARRANTIES, EXPRESS OR IMPLIED.

LIMITATIONS OF LIABILITY

OMRON SHALL NOT BE RESPONSIBLE FOR SPECIAL, INDIRECT, OR CONSEQUENTIAL DAMAGES, LOSS OF PROFITS, OR COMMERCIAL LOSS IN ANY WAY CONNECTED WITH THE PRODUCTS, WHETHER SUCH CLAIM IS BASED ON CONTRACT, WARRANTY, NEGLIGENCE, OR STRICT LIABILITY.

In no event shall responsibility of OMRON for any act exceed the individual price of the product on which liability is asserted.

IN NO EVENT SHALL OMRON BE RESPONSIBLE FOR WARRANTY, REPAIR, OR OTHER CLAIMS REGARDING THE PRODUCTS UNLESS OMRON'S ANALYSIS CONFIRMS THAT THE PRODUCTS WERE PROPERLY HANDLED, STORED, INSTALLED, AND MAINTAINED AND NOT SUBJECT TO CONTAMINATION, ABUSE, MISUSE, OR INAPPROPRIATE MODIFICATION OR REPAIR.

Application Considerations

SUITABILITY FOR USE

OMRON shall not be responsible for conformity with any standards, codes, or regulations that apply to the combination of products in the customer's application or use of the product.

At the customer's request, OMRON will provide applicable third party certification documents identifying ratings and limitations of use that apply to the products. This information by itself is not sufficient for a complete determination of the suitability of the products in combination with the end product, machine, system, or other application or use.

The following are some examples of applications for which particular attention must be given. This is not intended to be an exhaustive list of all possible uses of the products, nor is it intended to imply that the uses listed may be suitable for the products:

- Outdoor use, uses involving potential chemical contamination or electrical interference, or conditions or uses not described in this catalog.
- Nuclear energy control systems, combustion systems, railroad systems, aviation systems, medical equipment, amusement machines, vehicles, safety equipment, and installations subject to separate industry or government regulations.
- Systems, machines, and equipment that could present a risk to life or property.

Please know and observe all prohibitions of use applicable to the products.

NEVER USE THE PRODUCTS FOR AN APPLICATION INVOLVING SERIOUS RISK TO LIFE OR PROPERTY WITHOUT ENSURING THAT THE SYSTEM AS A WHOLE HAS BEEN DESIGNED TO ADDRESS THE RISKS, AND THAT THE OMRON PRODUCT IS PROPERLY RATED AND INSTALLED FOR THE INTENDED USE WITHIN THE OVERALL EQUIPMENT OR SYSTEM.

Disclaimers

CHANGE IN SPECIFICATIONS

Product specifications and accessories may be changed at any time based on improvements and other reasons.

It is our practice to change model numbers when published ratings or features are changed, or when significant construction changes are made. However, some specifications of the product may be changed without any notice. When in doubt, special model numbers may be assigned to fix or establish key specifications for your application on your request. Please consult with your OMRON representative at any time to confirm actual specifications of purchased product.

DIMENSIONS AND WEIGHTS

Dimensions and weights are nominal and are not to be used for manufacturing purposes, even when tolerances are shown.

ERRORS AND OMISSIONS

The information in this catalog has been carefully checked and is believed to be accurate; however, no responsibility is assumed for clerical, typographical, or proofreading errors, or omissions.

PERFORMANCE DATA

Performance data given in this catalog is provided as a guide for the user in determining suitability and does not constitute a warranty. It may represent the result of OMRON's test conditions, and the users must correlate it to actual application requirements. Actual performance is subject to the OMRON Warranty and Limitations of Liability.

PROGRAMMABLE PRODUCTS

OMRON shall not be responsible for the user's programming of a programmable product, or any consequence thereof.

COPYRIGHT AND COPY PERMISSION

This catalog shall not be copied for sales or promotions without permission.

This catalog is protected by copyright and is intended solely for use in conjunction with the product. Please notify us before copying or reproducing this catalog in any manner, for any other purpose. If copying or transmitting this catalog to another, please copy or transmit it in its entirety.



Компания «ЭлектроПласт» предлагает заключение долгосрочных отношений при поставках импортных электронных компонентов на взаимовыгодных условиях!

Наши преимущества:

- Оперативные поставки широкого спектра электронных компонентов отечественного и импортного производства напрямую от производителей и с крупнейших мировых складов;
- Поставка более 17-ти миллионов наименований электронных компонентов;
- Поставка сложных, дефицитных, либо снятых с производства позиций;
- Оперативные сроки поставки под заказ (от 5 рабочих дней);
- Экспресс доставка в любую точку России;
- Техническая поддержка проекта, помощь в подборе аналогов, поставка прототипов;
- Система менеджмента качества сертифицирована по Международному стандарту ISO 9001;
- Лицензия ФСБ на осуществление работ с использованием сведений, составляющих государственную тайну;
- Поставка специализированных компонентов (Xilinx, Altera, Analog Devices, Intersil, Interpoint, Microsemi, Aeroflex, Peregrine, Syfer, Eurofarad, Texas Instrument, Miteq, Cobham, E2V, MA-COM, Hittite, Mini-Circuits, General Dynamics и др.);

Помимо этого, одним из направлений компании «ЭлектроПласт» является направление «Источники питания». Мы предлагаем Вам помощь Конструкторского отдела:

- Подбор оптимального решения, техническое обоснование при выборе компонента;
- Подбор аналогов;
- Консультации по применению компонента;
- Поставка образцов и прототипов;
- Техническая поддержка проекта;
- Защита от снятия компонента с производства.



Как с нами связаться

Телефон: 8 (812) 309 58 32 (многоканальный)

Факс: 8 (812) 320-02-42

Электронная почта: org@eplast1.ru

Адрес: 198099, г. Санкт-Петербург, ул. Калинина, дом 2, корпус 4, литера А.