

## 6x8 MATRIX LED DRIVER

### DESCRIPTION

The IS32FL3738 is an automotive grade general purpose 6x8 LEDs matrix driver with 1/12 cycle rate. The device can be programmed via an I2C compatible interface. Each LED can be dimmed individually with 8-bit × 4 PWM data which allowing 512 steps of linear dimming.

IS32FL3738 features 3 Auto Breathing Modes which are noted as ABM-1, ABM-2 and ABM-3. For each Auto Breathing Mode, there are 4 timing characters which include current rising / holding / falling / off time and 3 loop characters which include Loop-Beginning / Loop-Ending / Loop-Times. Every LED can be configured to be any Auto Breathing Mode or No-Breathing Mode individually.

### FEATURES

- Up to 48 LEDs (6x8) in dot matrix
- Programmable 6x8 (16 RGBs) matrix size with de-ghost function
- Selectable 3 Auto Breath Modes for each dot
- Auto Breath Loop Features interrupt pin inform MCU Auto Breath Loop completed
- Auto Breath offers 128 steps gamma current, interrupt and state look up registers
- 256 steps Global Current Setting
- Individual 512 PWM control steps
- Individual Auto Breath Mode select
- Individual open and short error detect function

### QUICK START



Figure 1: Photo of IS32FL3738 Evaluation Board

(V01A board with 12V DC input please refer to Appendix I)

### RECOMMENDED EQUIPMENT

- 5.0V, 2A Micro USB
- Arduino IDE, [www.arduino.cc/en/Main/Software](http://www.arduino.cc/en/Main/Software)
- Arduino code download from ISSI website

### ABSOLUTE MAXIMUM RATINGS

- ≤ 5.5V Micro USB DC power supply

**Caution: Do not exceed the conditions listed above, otherwise the board will be damaged.**

### PROCEDURE

The IS32FL3738 evaluation board is fully assembled, tested and comes programmed with evaluation software. Follow the steps listed below to verify board operation.

**Caution: Do not turn on the power supply until all connections are completed.**

- 1) Connect the 5VDC USB power to the Micro USB.
- 2) Press K1 to cycle through a display mode.

### EVALUATION BOARD OPERATION

The IS32FL3738 evaluation board drives 16 RGB LEDs located underneath the light dispersing filter. Every press of the K1 switch will cycle through one of the 8 pre-programmed lighting sequences below:

- 1) White LED
- 2) Rainbow bar
- 3) Red color breath
- 4) Green color breath
- 5) Blue color breath
- 6) Pink color breath
- 7) Yellow color breath
- 8) Cyan color breath

**Note: IS32FL3738 solely controls the FxLED function on the evaluation board.**

### ORDERING INFORMATION

Part No.	Temperature Range	Package
IS32FL3738-ZLA3-EB	-40°C to +125°C (Automotive)	eTSSOP-28, Lead-free

Table 1: Ordering Information

For pricing, delivery, and ordering information, please contact ISSI's analog marketing team at [analog@issi.com](mailto:analog@issi.com) or (408) 969-6600.

### SOFTWARE CONTROL

The evaluation board comes with an Arduino compatible microcontroller circuit preloaded with IS32FL3738 demonstration firmware, called a sketch. This allows the functionality of the IS32FL3738 to be verified before starting firmware development.

The Arduino hardware consists of an Atmel microcontroller with a bootloader allowing quick firmware updates. First download the latest Arduino Integrated Development Environment IDE (1.6.12 or greater) from [www.arduino.cc/en/Main/Software](http://www.arduino.cc/en/Main/Software). Then download the latest IS32FL3738 firmware (sketch) from the ISSI website [www.issi.com/US/product-analog-automotive.shtml](http://www.issi.com/US/product-analog-automotive.shtml). When using the Arduino environment, please select Genuino UNO as shown below, then select the serial port. Follow the standard procedure to upload the latest IS32FL3738 firmware into the Arduino; then use the IDE to modify it. There is no additional software required to run the eval board.

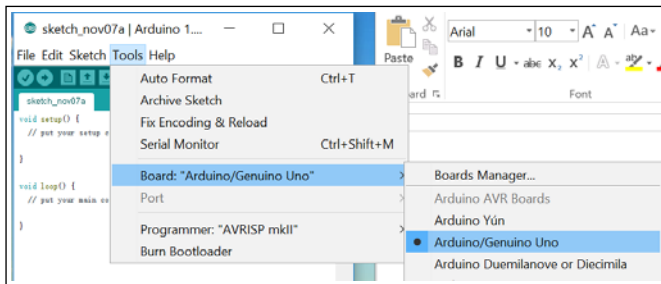

### EXT-SOFTWARE CONTROL

The IS32FL3738 can also be driven by an external IIC source.

Follow the steps below to configure the eval board for external control.

- 1) Open the two pins of J7 on the right side, to disable the onboard Arduino and enable external control (the SDA SCL and SDB become high impedance).
- 2) Default VIO is 5V, if you use a 3.3V IO, connect 3.3V to VIO pin in J7.
- 3) Connect SDB to VIO or high level IO
- 4) Connect external IIC to the IIC pins of J7
- 5) Start external IIC control.

*Please refer to the datasheet to get more information about IS32FL3738*

# 6x8 MATRIX LED DRIVER

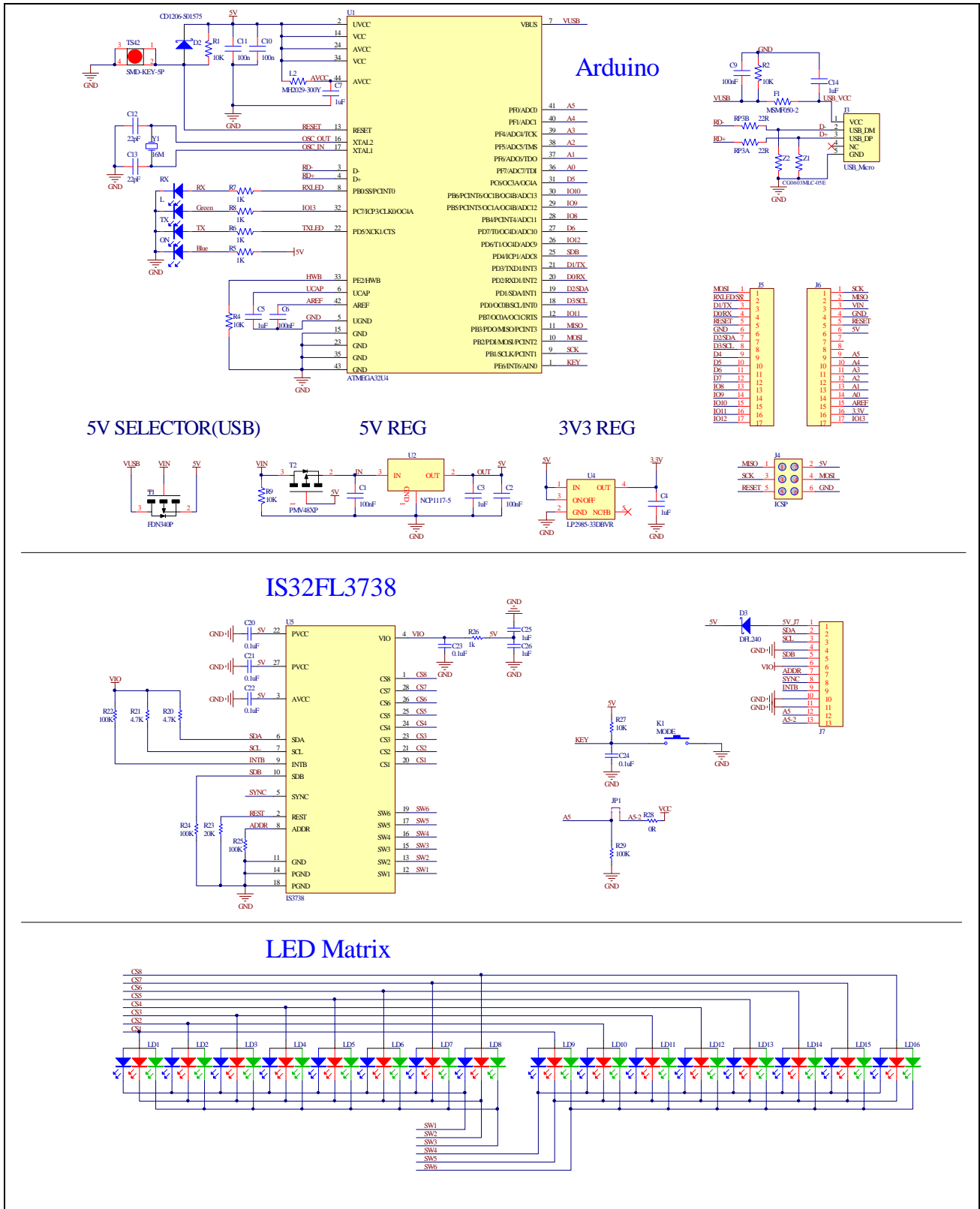

Figure 2: IS32FL3738 Application Schematic

## 6x8 MATRIX LED DRIVER

### BILL OF MATERIALS - Arduino

Name	Symbol	Description	Qty	Supplier	Part No.
MCU	U1	Microcontroller	1	ATM	ATMEGA32U4
LDO	U2	Reduced voltage	1	ON	NCP1117-5
LDO	U4	Reduced voltage	1	TI	LP2985-33DBVR
Triode	T1	FET	1	FAIRCHILD	FDN340P
Triode	T2	FET	1	NXP	PMV48XP
Crystal	Y1	Crystal, 16MHz	1	Risym	3225 16MHz
Button	K1	Button SMD	1	MT	SMD-KEY-5P
LED	ON,TX,RX	LED, SMD Blue	3	EVERLIGHT	0603
LED	L	LED, SMD Green	1	EVERLIGHT	0603
F1	F1	SMD Fuse	1	MF	MSMF050-2
Beads	L2	Beads	1	BOURNS	MH2029-300Y
Diode	D2	Diode, SMD	1	BOURNS	CD1206-S01575
Varistor	Z1,Z2	Varistor	2	BOURNS	CG0603MLC-05E
Resistor	RP3A,PR3B	RES,22R,1/16W,±5%,SMD	2	Yageo	RC0603JR-0722RL
Resistor	R5,R6,R7,R8	RES,1k,1/16W,±5%,SMD	4	Yageo	RC0603JR-071KL
Resistor	R1,R2,R4,R9	RES,10k,1/16W,±5%,SMD	4	Yageo	RC0603JR-0710KL
Capacitor	C12,C13	CAP,22pF,16V,±20%,SMD	2	Yageo	CC0603KKX7R9BB22
Capacitor	C1,C2,C6,C9,C10,C11	CAP,100nF,16V,±20%,SMD	6	Yageo	CC0603KKX7R9BB101
Capacitor	C3,C4,C5,C7,C14	CAP,1µF,16V, ±20%,SMD	4	Yageo	CC0603KKX7R9BB105

### BILL OF MATERIALS – IS32FL3738

Name	Symbol	Description	Qty	Supplier	Part No.
LED Driver	U5	Matrix LED Driver	1	ISSI	IS32FL3738
RGB LED	LD1~LD16	RGB LED, SMD	16	ROHM	SMLV56RGB1W1
Diode	D3	Diode, SMD	1	DIODES	DFLS240
Resistor	R20,R21	RES,4.7k,1/16W,±5%,SMD	2	Yageo	RC0603JR-074K7L
Resistor	R22,R24,R25,R29	RES,100k,1/16W,±5%,SMD	4	Yageo	RC0603JR-07100KL
Resistor	R23	RES,20k,1/16W,±5%,SMD	1	Yageo	RC0603JR-0720KL
Resistor	R26	RES,1k,1/16W,±5%,SMD	1	Yageo	RC0603JR-071KL
Resistor	R27	RES,10k,1/16W,±5%,SMD	1	Yageo	RC0603JR-0710KL
Resistor	R28	RES,0k,1/16W,±5%,SMD	1	Yageo	RC0603JR-070KL
Capacitor	C20,C21,C22,C23,C24	CAP,0.1µF,16V,±20%,SMD	5	Yageo	CC0603KKX7R9BB104
Capacitor	C25,C26	CAP,1µF,16V,±20%,SMD	2	Yageo	CC0603KKX7R9BB105
Button	K1(Bottom)	Button	1		

Bill of Materials, refer to Figure 1 above.

6x8 MATRIX LED DRIVER

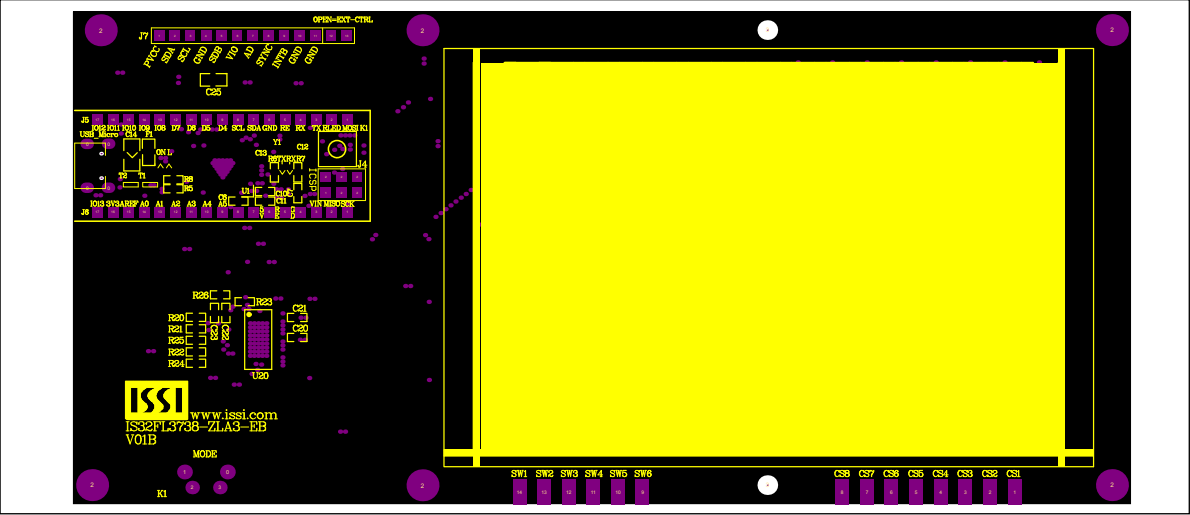

Figure 3: Board Component Placement Guide - Top Layer

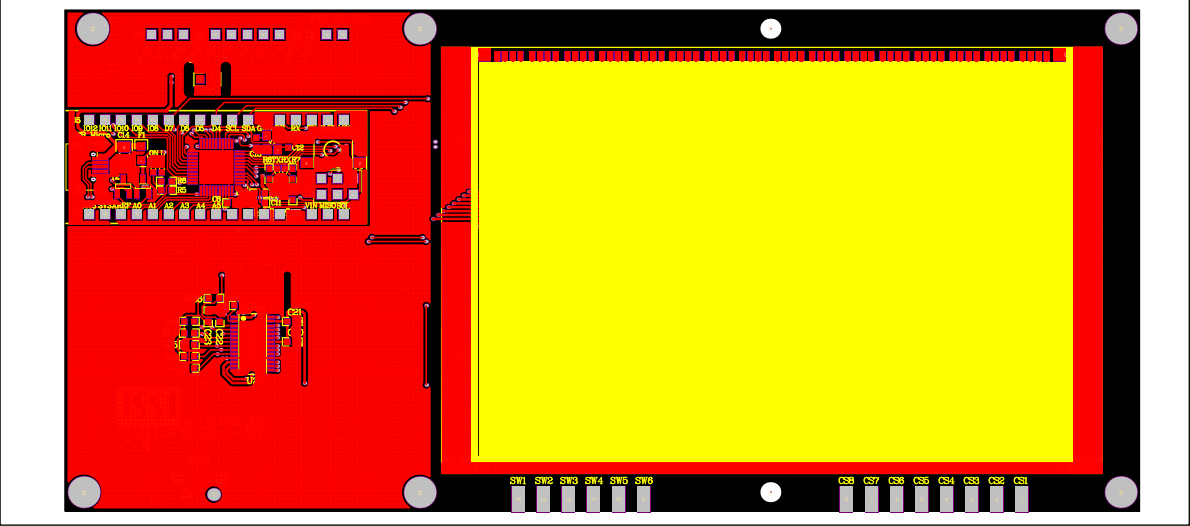

Figure 4: Board PCB Layout - Top Layer

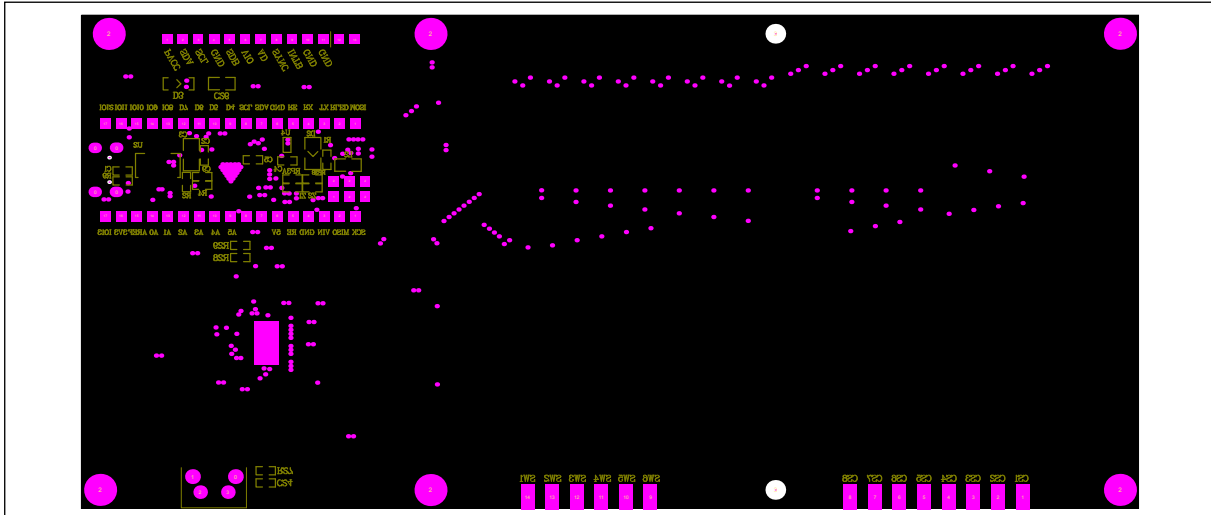

Figure 5: Board Component Placement Guide - Bottom Layer

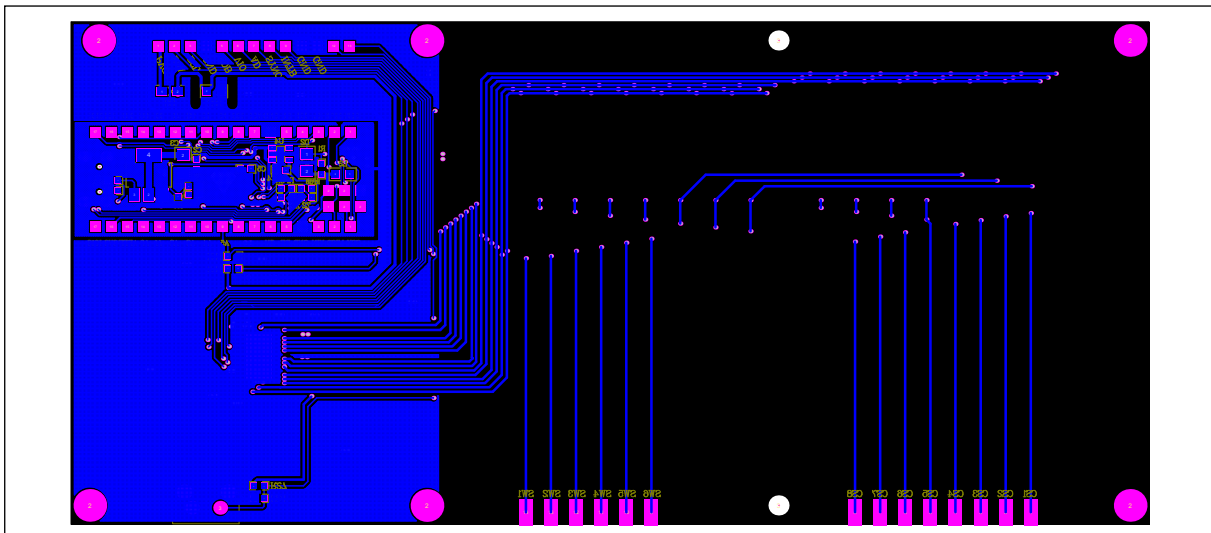

Figure 6: Board PCB Layout - Bottom Layer

Copyright © 2017 Integrated Silicon Solution, Inc. All rights reserved. ISSI reserves the right to make changes to this specification and its products at any time without notice. ISSI assumes no liability arising out of the application or use of any information, products or services described herein. Customers are advised to obtain the latest version of this device specification before relying on any published information and before placing orders for products. Integrated Silicon Solution, Inc. does not recommend the use of any of its products in life support applications where the failure or malfunction of the product can reasonably be expected to cause failure of the life support system or to significantly affect its safety or effectiveness. Products are not authorized for use in such applications unless Integrated Silicon Solution, Inc. receives written assurance to its satisfaction, that:

- a.) the risk of injury or damage has been minimized;
- b.) the user assume all such risks; and
- c.) potential liability of Integrated Silicon Solution, Inc is adequately protected under the circumstances



## 6x8 MATRIX LED DRIVER

---

### REVISION HISTORY

---

Revision	Detail Information	Date
A	Initial release	2016.09.18
B	1. Deleted 12V, 1A power supply. 2. Update schematic and PCB. 3. Update bill of materials	2016.11.04
C	Correct the PWM level to 512 levels, please check datasheet for more information.	2017.03.22

## APPENDIX I : V01A GUIDE

### QUICK START

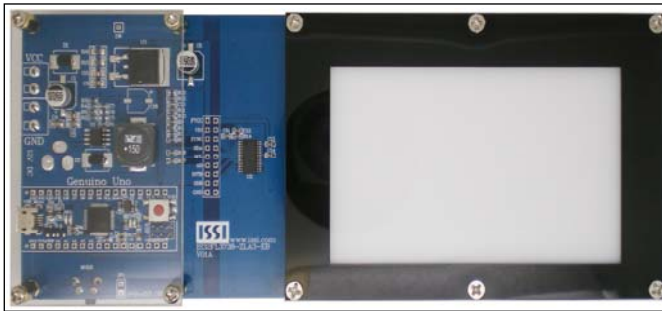

Figure 7: Photo of IS32FL3738 Evaluation Board

### RECOMMENDED EQUIPMENT V01A

- 5.0V, 2A Micro USB or 12V, 1A power supply

### ABSOLUTE MAXIMUM RATINGS V01A

- ≤ 17V DC power supply
- ≤ 5.5V Micro USB DC power supply

**Caution:** Do not exceed the conditions listed above, otherwise the board will be damaged.

### PROCEDURE V01A

The IS32FL3738 evaluation board is fully assembled and tested. Follow the steps listed below to verify board operation.

**Caution:** Do not turn on the power supply until all connections are completed.

- 1) Connect the 12VDC power to the connector or 5VDC USB power to the Micro USB.
- 2) Turn on the power supply, pay attention to the supply current. If the current exceeds 1A, please check for circuit fault.

### EVALUATION BOARD OPERATION V01A

The IS32FL3738 evaluation board has three animation display modes. Press K1 to switch configurations.

- 1) White LED

- 2) Rainbow bar
- 3) Red LED breath
- 4) Green LED breath
- 5) Blue LED breath
- 6) Red and blue LED breath
- 7) Red and green LED breath
- 8) Blue and green LED breath

**Note:** IS32FL3738 solely controls the FxLED function on the evaluation board.

### SOFTWARE CONTROL

The IS32FL3738 use Arduino as its master controller, if using Arduino environment, please select Genuino UNO. No driver is needed when initial the hardware.

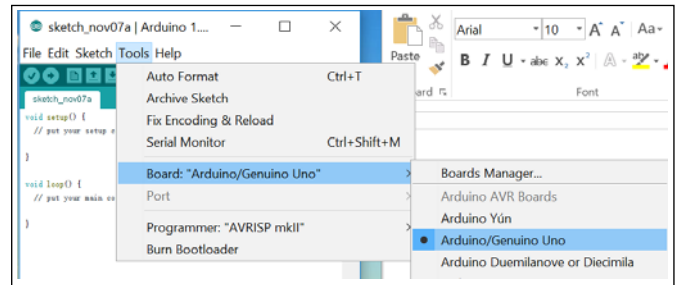

### EXT-SOFTWARE CONTROL V01A

The IS32FL3738 can set its I2C bus interface logic threshold based on the voltage on the VIO pin.

Follow the steps listed below for external control.

- 1) Open JP1 to disconnect the I2C communication, and connect an external MCU VCC to VIO.
- 2) Pull-up the SDB to VIO.
- 3) Connect the 12VDC power to the connector or 5VDC power to the Micro USB.
- 4) Turn on the power supply pay attention to the supply current. If the current exceeds 1A, please check for circuit fault.
- 5) Start external IIC control.

**Please refer to the datasheet to get more information about IS32FL3738**



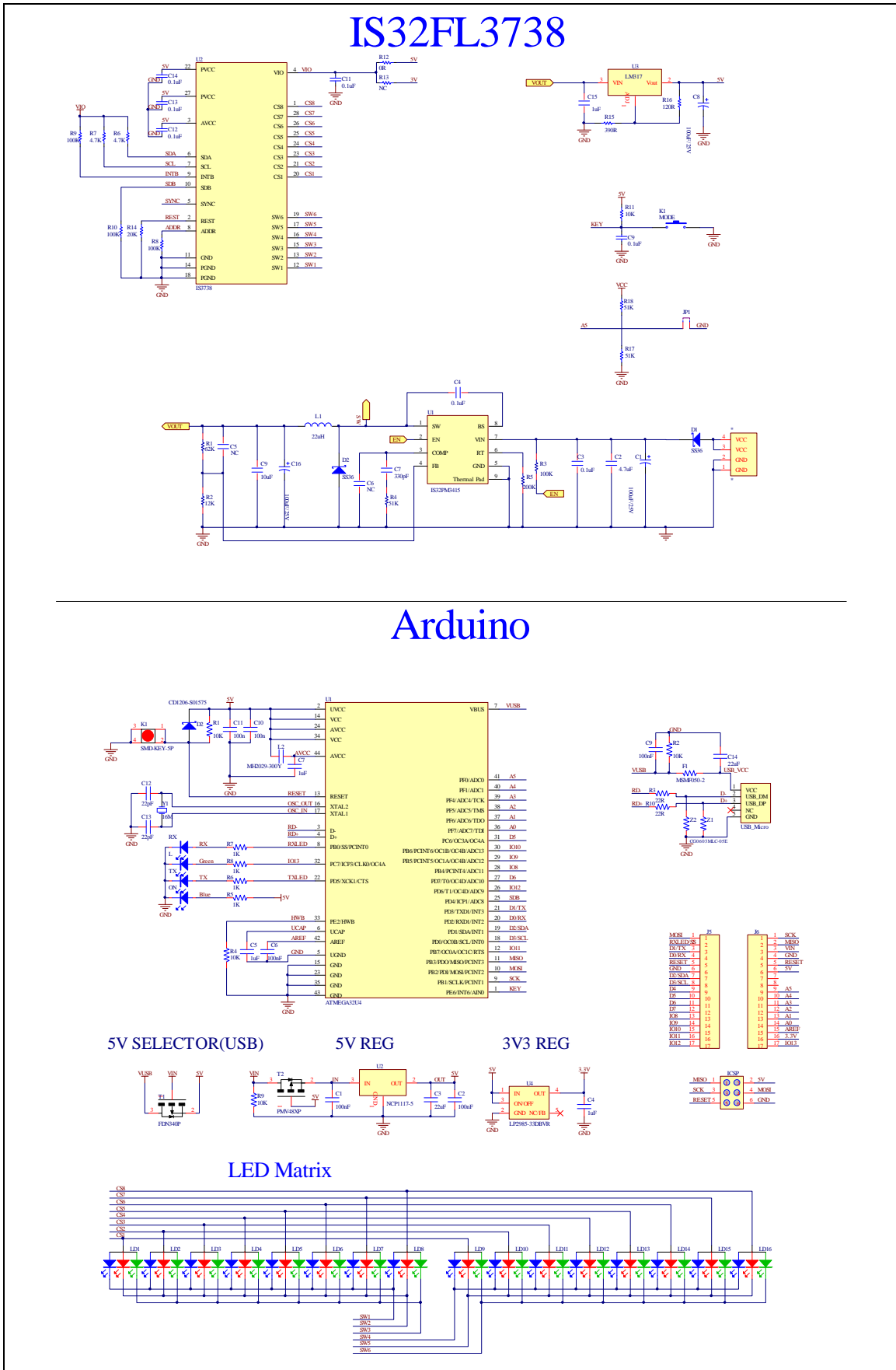

Figure 8: IS32FL3738 Application Schematic: V01A

## 6x8 MATRIX LED DRIVER

### BILL OF MATERIALS (EVB Part)

Name	Symbol	Description	Qty	Supplier	Part No.
Buck Chip	U1	Buck Chip	1	ISSI	IS32PM3415
LED Driver	U2	Matrix LED Driver	1	ISSI	IS32FL3738
LDO	U3	Reduced voltage	1	ST	LM317D2T
Diode	LD1~LD16	RGB LED, SMD	16	ROHM	SMLV56RGB1W1
Diode	D1,D2	Diode, SMD	2	DIODES	SS36
Resistor	R5	RES,200k,1/16W,±5%,SMD	1	Yageo	RC0603JR-07200KL
Resistor	R3,R8,R9,R10	RES,100k,1/16W,±5%,SMD	4	Yageo	RC0603JR-07100KL
Resistor	R1	RES,62k,1/16W,±5%,SMD	1	Yageo	RC0603JR-0762KL
Resistor	R4,R17,R18	RES,51k,1/16W,±5%,SMD	3	Yageo	RC0603JR-0751KL
Resistor	R14	RES,20k,1/16W,±5%,SMD	1	Yageo	RC0603JR-0720KL
Resistor	R2	RES,12k,1/16W,±5%,SMD	1	Yageo	RC0603JR-0712KL
Resistor	R11	RES,10k,1/16W,±5%,SMD	1	Yageo	RC0603JR-0710KL
Resistor	R6,R7	RES,4.7k,1/16W,±5%,SMD	2	Yageo	RC0603JR-074K7L
Resistor	R15	RES,390R,1/16W,±5%,SMD	1	Yageo	RC0603JR-07390RL
Resistor	R16	RES,120R,1/16W,±5%,SMD	1	Yageo	RC0603JR-07120RL
Resistor	R12	RES,0R,1/16W,±5%,SMD	1	Yageo	RC0603JR-070RL
Resistor	R13	NC	1		
Capacitor	C15	CAP,1µF,16V,±20%,SMD	1	Yageo	CC0603KKX7R9BB105
Capacitor	C7	CAP,330pF,16V,±20%,SMD	1	Yageo	CC0603KKX7R9BB331
Capacitor	C4,12	CAP,4.7µF,16V, ±20%,SMD	2	Yageo	CC0603KKX7R9BB476
Capacitor	C6,C7	CAP,33pF,16V,±20%,SMD	2	Yageo	CC0603KKX7R9BB330
Capacitor	C8,C9,C10	CAP,0.1µF,16V,±20%,SMD	3	Yageo	CC0603KKX7R9BB104
Button	K1	Button SMD	1		

## 6x8 MATRIX LED DRIVER

### BILL OF MATERIALS (Genuino Uno Part)

Name	Symbol	Description	Qty	Supplier	Part No.
MCU	U1	Microcontroller	1	ATM	ATMEGA32U4
LDO	U2	Reduced voltage	1	ON	NCP1117-5
LDO	U4	Reduced voltage	1	TI	LP2985-33DBVR
Triode	T1	FET	1	FAIRCHILD	FDN340P
Triode	T2	FET	1	NXP	PMV48XP
Crystal	Y1	Crystal, 16MHz	1	Risym	3225 16MHz
Button	K1	Button SMD	1	MT	SMD-KEY-5P
LED	ON,TX,RX	LED, SMD Blue	3	EVERLIGHT	0603
LED	L	LED, SMD Greed	1	EVERLIGHT	0603
F1	F1	SMD Fuse	1	MF	MSMF050-2
Beads	L2	Beads	1	BOURNS	RC0603JR-0712KL
Varistor	Z1,Z2	Varistor	2	BOURNS	CG0603MLC-05E
Resistor	R3,R10	RES,22R,1/16W,±5%,SMD	2	Yageo	RC0603JR-0722RL
Resistor	R5,R6,R7,R8	RES,1k,1/16W,±5%,SMD	4	Yageo	RC0603JR-071KL
Resistor	R1,R2,R4	RES,10k,1/16W,±5%,SMD	3	Yageo	RC0603JR-0710KL
Capacitor	C12,C13	CAP,22pF,16V,±20%,SMD	2	Yageo	CC0603KKX7R9BB22
Capacitor	C1,C2,C6, C9,C10,C11	CAP,100nF,16V,±20%,SMD	6	Yageo	CC0603KKX7R9BB101
Capacitor	C4,C5	CAP,1µF,16V, ±20%,SMD	2	Yageo	CC0603KKX7R9BB105
Capacitor	C3,C14	CAP,22µF,16V,±20%,SMD	2	Yageo	CC0603KKX7R9BB226
Diode	D2	Diode, SMD	1	BOURNS	CD1206-S01575

*Bill of Materials, refer to Figure 1 above.*

# 6x8 MATRIX LED DRIVER

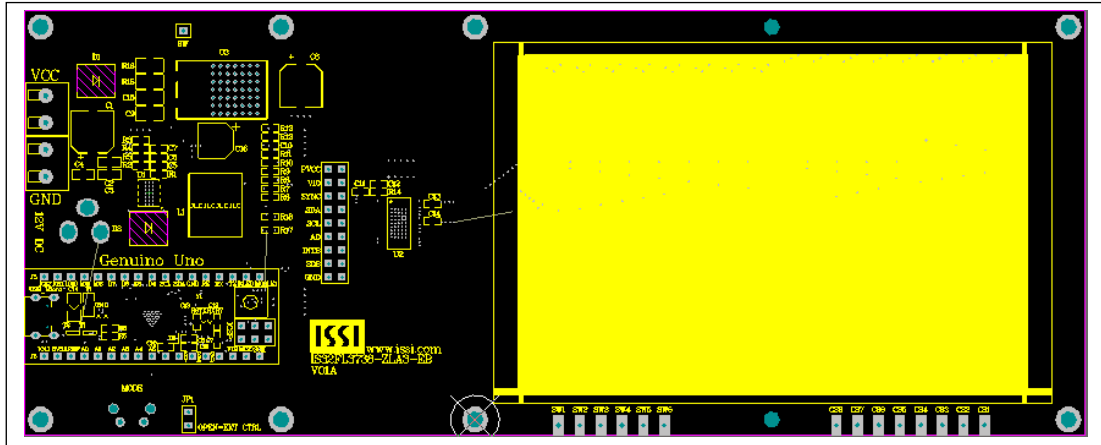

Figure 9: Board Component Placement Guide - Top Layer: V01A

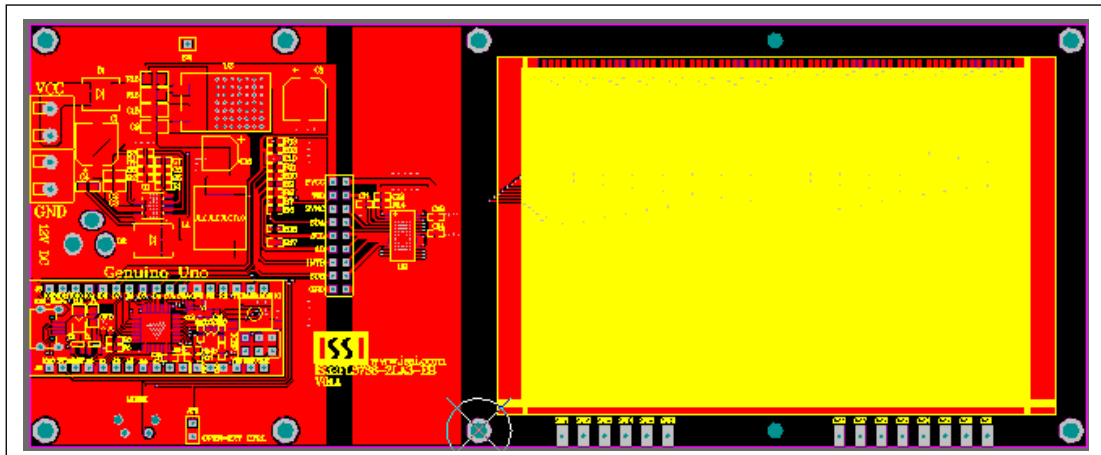

Figure 10: Board PCB Layout - Top Layer: V01A

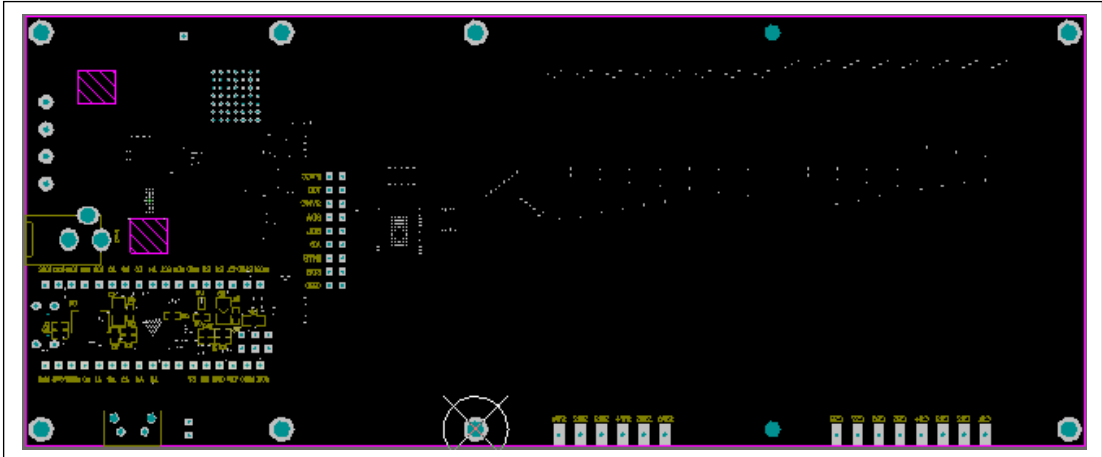

Figure 11: Board Component Placement Guide - Bottom Layer: V01A

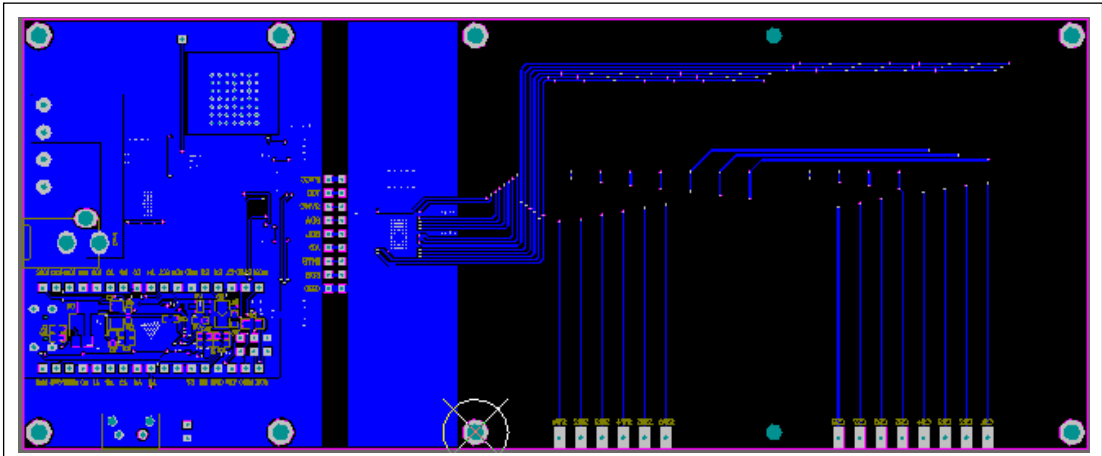

Figure 12: Board PCB Layout - Bottom Layer: V01A



Компания «ЭлектроПласт» предлагает заключение долгосрочных отношений при поставках импортных электронных компонентов на взаимовыгодных условиях!

Наши преимущества:

- Оперативные поставки широкого спектра электронных компонентов отечественного и импортного производства напрямую от производителей и с крупнейших мировых складов;
- Поставка более 17-ти миллионов наименований электронных компонентов;
- Поставка сложных, дефицитных, либо снятых с производства позиций;
- Оперативные сроки поставки под заказ (от 5 рабочих дней);
- Экспресс доставка в любую точку России;
- Техническая поддержка проекта, помощь в подборе аналогов, поставка прототипов;
- Система менеджмента качества сертифицирована по Международному стандарту ISO 9001;
- Лицензия ФСБ на осуществление работ с использованием сведений, составляющих государственную тайну;
- Поставка специализированных компонентов (Xilinx, Altera, Analog Devices, Intersil, Interpoint, Microsemi, Aeroflex, Peregrine, Syfer, Eurofarad, Texas Instrument, Miteq, Cobham, E2V, MA-COM, Hittite, Mini-Circuits, General Dynamics и др.);

Помимо этого, одним из направлений компании «ЭлектроПласт» является направление «Источники питания». Мы предлагаем Вам помощь Конструкторского отдела:

- Подбор оптимального решения, техническое обоснование при выборе компонента;
- Подбор аналогов;
- Консультации по применению компонента;
- Поставка образцов и прототипов;
- Техническая поддержка проекта;
- Защита от снятия компонента с производства.



#### Как с нами связаться

**Телефон:** 8 (812) 309 58 32 (многоканальный)

**Факс:** 8 (812) 320-02-42

**Электронная почта:** [org@eplast1.ru](mailto:org@eplast1.ru)

**Адрес:** 198099, г. Санкт-Петербург, ул. Калинина, дом 2, корпус 4, литера А.