

## 1 Features and Benefits

- Wide operating voltage range: from 2.7V to 24V
- Accurate switching thresholds
- Reverse Supply Voltage Protection
- Output Current Limit with Auto-Shutoff
- Under-Voltage Lockout Protection
- Thermal Protection
- Traceability with integrated unique ID
- High ESD rating / Excellent EMC performance

## 2 Application Examples

- Automotive, Consumer and Industrial
- Solid-state switch
- Brake sensor
- Clutch sensor
- Sunroof/Tailgate opener
- Steering Column Lock
- Open/Close detection

## 3 Ordering Information

Product Code	Temperature Code	Package Code	Option Code	Packing from Code
MLX92231	L	SE	AAA-0xx	RE
MLX92231	L	UA	AAA-0xx	BU
MLX92231	L	SE	AAA-2xx	RE

### Legend:

Temperature Code:	L (-40°C to 150°C)
Package Code:	SE = TSOT-3L / UA = TO92-3L
Option Code:	0xx => 3 wire Hall Effect Switch 2xx => IMC version
Packing Form:	RE = Reel   BU=Bulk
Ordering Example:	MLX92231LSE-AAA-001-RE

## 4 Functional Diagram

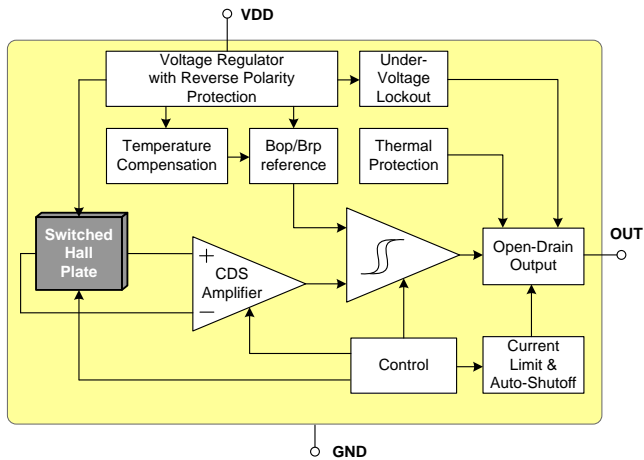

## 5 General Description

The Melexis MLX92231 is a Hall-effect unipolar switch designed in mixed signal CMOS technology.

The device integrates a voltage regulator, Hall sensor with advanced offset cancellation system, automotive qualified EEPROM and an open-drain output driver, all in a single package.

Based on the existing robust 922xx platform, the magnetic core has been equipped with a non-volatile memory that is used to accurately trim the switching thresholds and define the needed output magnetic characteristics (TC,  $B_{OP}$ ,  $B_{RP}$ , Output pole functionality).

In addition to that an ID has been integrated on the IC to have a complete traceability throughout the process flow.

The included voltage regulator operates from 2.7 to 24V, hence covering a wide range of applications. With the built-in reverse voltage protection, a serial resistor or diode on the supply line is not required so that even remote sensors can be specified for low voltage operation down to 2.7V while being reverse voltage tolerant.

In the event of a drop below the minimum supply voltage during operation, the under-voltage lock-out protection will automatically freeze the device, preventing the electrical perturbation to affect the magnetic measurement circuitry. The output state is therefore only updated based on a proper and accurate magnetic measurement result.

The chopper-stabilized amplifier uses switched capacitor techniques to suppress the offset generally observed with Hall sensors and amplifiers. The CMOS technology makes this advanced technique possible and contributes to smaller chip size and lower current consumption than bipolar technology. The small chip size is also an important factor to minimize the effect of physical stress. This combination results in more stable magnetic characteristics and enables faster and more precise design.

The open drain output is fully protected against short-circuit with a built-in current limit. An additional automatic output shut-off is activated in case of a prolonged short-circuit condition. A self-check is then periodically performed to switch back to normal operation if the short-circuit condition is released. The on-chip thermal protection also switches off the output if the junction temperature increases above an abnormally high threshold. It will automatically recover once the temperature decreases below a safe value.

## Table of Contents

<b>1</b>	<b>Features and Benefits</b> .....	<b>1</b>
<b>2</b>	<b>Application Examples</b> .....	<b>1</b>
<b>3</b>	<b>Ordering Information</b> .....	<b>1</b>
<b>4</b>	<b>Functional Diagram</b> .....	<b>2</b>
<b>5</b>	<b>General Description</b> .....	<b>2</b>
<b>6</b>	<b>Glossary of Terms</b> .....	<b>5</b>
<b>7</b>	<b>Absolute Maximum Ratings</b> .....	<b>5</b>
<b>8</b>	<b>General Electrical Specifications</b> .....	<b>6</b>
<b>9</b>	<b>Magnetic Specifications</b> .....	<b>7</b>
9.1	MLX92231LSE-AAA-004.....	7
9.2	MLX92231LSE-AAA-005.....	7
9.3	MLX92231LSE-AAA-007.....	7
9.4	MLX92231LSE-AAA-009.....	8
9.5	MLX92231LSE-AAA-010.....	8
9.6	MLX92231LSE-AAA-013.....	8
9.7	MLX92231LSE-AAA-014.....	8
9.8	MLX92231LSE-AAA-019.....	9
9.9	MLX92231LSE-AAA-021.....	9
9.10	MLX92231LSE-AAA-023.....	9
9.11	MLX92231LSE-AAA-026.....	9
9.12	MLX92231LSE-AAA-029.....	10
9.13	MLX92231LSE-AAA-031.....	10
9.14	MLX92231LSE-AAA-032.....	10
9.15	MLX92231LSE-AAA-033.....	10
9.16	MLX92231LUA-AAA-034.....	11
9.17	MLX92231LUA-AAA-039.....	11
9.18	MLX92231LSE-AAA-040.....	11
9.19	MLX92231LSE-AAA-041.....	11
9.20	MLX92231LSE-AAA-042.....	12
9.21	MLX92231LSE-AAA-049.....	12
9.22	MLX92231LSE-AAA-204.....	12
<b>10</b>	<b>Magnetic Behaviour</b> .....	<b>14</b>
<b>11</b>	<b>Application Information</b> .....	<b>15</b>
11.1	Typical Three-Wire Application Circuit.....	15
11.2	Automotive and Harsh, Noisy Environments Three-Wire Circuit.....	15
<b>12</b>	<b>Standard information regarding manufacturability of Melexis products with different soldering processes</b> ...	<b>16</b>
<b>13</b>	<b>ESD Precautions</b> .....	<b>16</b>

# MLX92231-AAA-xxx

## 3-Wire Hall Effect Switch

Datasheet



<b>14</b>	<b>Package Information.....</b>	<b>17</b>
14.1	SE (TSOT-3L) Package Information.....	17
14.2	UA (TO92-3L) Package Information .....	18
<b>15</b>	<b>Contact.....</b>	<b>19</b>
<b>16</b>	<b>Disclaimer.....</b>	<b>19</b>

## 6 Glossary of Terms

Tesla	Units for the magnetic flux density, 1 mT = 10 Gauss
TC	Temperature Coefficient in ppm/°C
IMC	Integrated Magnetic Concentrator
POR	Power on Reset

## 7 Absolute Maximum Ratings

Exceeding the absolute maximum ratings may cause permanent damage. Exposure to absolute maximum rated conditions for extended periods may affect device reliability.

Parameter	Symbol	Value	Units
Supply Voltage <sup>(1, 2)</sup>	V <sub>DD</sub>	+27	V
Supply Voltage (Load Dump) <sup>(1, 4)</sup>	V <sub>DD</sub>	+32	V
Supply Current <sup>(1, 2, 3)</sup>	I <sub>DD</sub>	+20	mA
Supply Current <sup>(1, 3, 4)</sup>	I <sub>DD</sub>	+50	mA
Reverse Supply Voltage <sup>(1, 2)</sup>	V <sub>DDREV</sub>	-24	V
Reverse Supply Voltage <sup>(1, 4)</sup>	V <sub>DDREV</sub>	-30	V
Reverse Supply Current <sup>(1, 2, 5)</sup>	I <sub>DDREV</sub>	-20	mA
Reverse Supply Current <sup>(1, 4, 5)</sup>	I <sub>DDREV</sub>	-50	mA
Output Voltage <sup>(1, 2)</sup>	V <sub>OUT</sub>	+27	V
Output Current <sup>(1, 2, 5)</sup>	I <sub>OUT</sub>	+20	mA
Output Current <sup>(1, 4, 6)</sup>	I <sub>OUT</sub>	+75	mA
Reverse Output Voltage <sup>(1)</sup>	V <sub>OUTREV</sub>	-0.5	V
Reverse Output Current <sup>(1, 2)</sup>	I <sub>OUTREV</sub>	-100	mA
Maximum Junction Temperature <sup>(7)</sup>	T <sub>J</sub>	+165	°C
Storage Temperature Range	T <sub>S</sub>	-55 to +165	°C
ESD Sensitivity – HBM <sup>(8)</sup>	-	4000	V
ESD Sensitivity – CDM <sup>(9)</sup>	-	1000	V
Magnetic Flux Density	B	Unlimited	mT

*Absolute maximum ratings*

<sup>1</sup> The maximum junction temperature should not be exceeded

<sup>2</sup> For maximum 1 hour

<sup>3</sup> Including current through protection device

<sup>4</sup> For maximum 500ms

<sup>5</sup> Through protection device

<sup>6</sup> For V<sub>OUT</sub> ≤ 27V

<sup>7</sup> For 1000 hours

<sup>8</sup> Human Model according AEC-Q100-002 standard

<sup>9</sup> Charged Device Model according AEC-Q100-011 standard

## 8 General Electrical Specifications

DC Operating Parameters  $V_{DD} = 2.7V$  to  $24V$ ,  $T_A = -40^{\circ}C$  to  $150^{\circ}C$  (unless otherwise specified)

Parameter	Symbol	Test Conditions	Min	Typ <sup>(1)</sup>	Max	Units
Supply Voltage	$V_{DD}$	Operating	2.7	-	24	V
Supply Current	$I_{DD}$		1.5	3.0	4.5	mA
Reverse supply current	$I_{DDREV}$	$V_{DD} = -16V$	-1	-	-	mA
Output Saturation Voltage	$V_{DSON}$	$V_{DD} = 3.5$ to $24V$ , $I_{OUT} = 20mA$	-	0.3	0.5	V
Output Leakage	$I_{OFF}$	$V_{OUT} = 12V$ , $V_{DD} = 12V$	-	-	10	$\mu A$
Output Rise Time <sup>(2,6)</sup> ( $R_{PU}$ dependent)	$t_R$	$R_{PU} = 1k\Omega$ , $V_{DD} = 12V$ , $V_{PU} = 5V$ $C_{LOAD} = 50pF$ to GND	0.1	0.3	1	$\mu s$
Output Fall Time <sup>(2,6)</sup> (On-chip controlled)	$t_F$	$R_{PU} = 1k\Omega$ , $V_{DD} = 12V$ , $V_{PU} = 5V$ $C_{LOAD} = 50pF$ to GND	0.1	0.3	1	$\mu s$
Power-On Time <sup>(3,4,7)</sup>	$t_{ON}$	$V_{DD} = 5V$ , $dV_{DD}/dt > 2V/us$	-	40	70	$\mu s$
Power-On Output State	-	$t < t_{ON}$	High ( $V_{PU}$ )			-
Output Current Limit	$I_{CL}$	$V_{DD} = 3.5$ to $24V$ , $V_{OUT} = 12V$	25	40	70	mA
Output ON Time under Current Limit conditions <sup>(8)</sup>	$t_{CLON}$	$V_{PU} = 12V$ , $R_{PU} = 100\Omega$	150	240		$\mu s$
Output OFF Time under Current Limit conditions <sup>(8)</sup>	$t_{CLOFF}$	$V_{PU} = 12V$ , $R_{PU} = 100\Omega$	-	3.5	-	ms
Chopping Frequency	$f_{CHOP}$		-	340	-	kHz
Refresh Period	$t_{PER}$		-	6	-	$\mu s$
Output Jitter (p-p) <sup>(2)</sup>	$t_{JITTER}$	Over 1000 successive switching events @10kHz triangle wave magnetic field, $B > \pm(B_{OPMAX} + 20mT)$	-	$\pm 3.2$	-	$\mu s$
Maximum Switching Frequency <sup>(2,5)</sup>	$f_{SW}$	$B > \pm 3(B_{OPMAX} + 1mT)$ , triangle wave magnetic field	30	65	-	kHz
Under-voltage Lockout Threshold	$V_{UVL}$		-	-	2.7	V
Under-voltage Lockout Reaction time <sup>(2)</sup>	$t_{UVL}$		-	1	-	$\mu s$
Thermal Protection Threshold	$T_{PROT}$	Junction temperature	-	190 <sup>(9)</sup>	-	$^{\circ}C$
Thermal Protection Release	$T_{REL}$	Junction temperature	-	180 <sup>(9)</sup>	-	$^{\circ}C$
SE Package Thermal Resistance	$R_{THJA}$	Single layer PCB, JEDEC standard test boards		300		$^{\circ}C/W$
UA package Thermal Resistance	$R_{THJA}$	Single layer PCB, JEDEC standard test boards		200		$^{\circ}C/W$

### General Electrical parameters

1 Typical values are defined at  $T_A = +25^{\circ}C$  and  $V_{DD} = 12V$

2 Guaranteed by design and verified by characterization, not production tested

3 The Power-On Time represents the time from reaching  $V_{DD} = 2.7V$  to the first refresh of the output

4 Power-On Slew Rate is not critical for the proper device start-up.

5 Maximum switching frequency corresponds to the maximum frequency of the applied magnetic field which is detected without loss of pulses

6  $R_{PU}$  and  $V_{PU}$  are respectively the external pull-up resistor and pull-up power supply

7 Activated output with 1 mT overdrive

8 If the Output is in Current Limitation longer than  $t_{CLON}$  the Output is switched off in high-impedance state. The Output returns back in active state at next reaching of  $B_{OP}$  or after  $t_{CLOFF}$  time interval

9  $T_{PROT}$  and  $T_{REL}$  are the corresponding junction temperature values

## 9 Magnetic Specifications

### 9.1 MLX92231LSE-AAA-004

DC Operating Parameters  $V_{DD} = 3.5V$  to  $24V$ ,  $T_A = -40^{\circ}C$  to  $150^{\circ}C$

Test Condition	Operating Point $B_{OP}$ (mT)			Release Point $B_{RP}$ (mT)			TC (ppm/ $^{\circ}C$ )	Output Polarity Active Pole	Package Information
	Min	Typ <sup>(1)</sup>	Max	Min	Typ <sup>(1)</sup>	Max			
$T_A = -40^{\circ}C$	-7.7	-5.9	-4.3	-5.6	-4.0	-2.3	-1100 <sup>(2)</sup>	Z-axis sensitive Direct Switch North Pole	SE (TSOT-3L)
$T_A = 25^{\circ}C$	-6.8	-5.5	-4.2	-5.0	-3.7	-2.3			
$T_A = 150^{\circ}C$	-6.8	-4.7	-3.1	-5.0	-3.2	-1.5			

### 9.2 MLX92231LSE-AAA-005

DC Operating Parameters  $V_{DD} = 3.5V$  to  $24V$ ,  $T_A = -40^{\circ}C$  to  $150^{\circ}C$

Test Condition	Operating Point $B_{OP}$ (mT) <sup>(3)</sup>			Release Point $B_{RP}$ (mT) <sup>(3)</sup>			TC (ppm/ $^{\circ}C$ )	Output Polarity Active Pole	Package Information
	Min	Typ <sup>(1)</sup>	Max	Min	Typ <sup>(1)</sup>	Max			
$T_A = -40^{\circ}C$							-1100 <sup>(2)</sup>	Z-axis sensitive Direct Switch North Pole	SE (TSOT-3L)
$T_A = 25^{\circ}C$	-26			-20					
$T_A = 150^{\circ}C$									

### 9.3 MLX92231LSE-AAA-007

DC Operating Parameters  $V_{DD} = 3.5V$  to  $24V$ ,  $T_A = -40^{\circ}C$  to  $150^{\circ}C$

Test Condition	Operating Point $B_{OP}$ (mT) <sup>(3)</sup>			Release Point $B_{RP}$ (mT) <sup>(3)</sup>			TC (ppm/ $^{\circ}C$ )	Output Polarity Active Pole	Package Information
	Min	Typ <sup>(1)</sup>	Max	Min	Typ <sup>(1)</sup>	Max			
$T_A = -40^{\circ}C$	20.0	26.0	33.0	14.0	20.0	25.0	0 <sup>(2)</sup>	Z-axis sensitive Direct Switch South Pole	SE (TSOT-3L)
$T_A = 25^{\circ}C$	20.0	26.0	33.0	14.0	20.0	25.0			
$T_A = 150^{\circ}C$	20.0	26.0	33.0	14.0	20.0	25.0			

<sup>1</sup> Typical values are defined at  $T_A = +25^{\circ}C$  and  $V_{DD} = 12V$

<sup>2</sup> Temperature coefficient is calculated using the following formula:

$$\frac{B_{OPT2} - B_{OPT1}}{B_{OP25^{\circ}C}} \times (T_2 - T_1) * 10^6, ppm / ^{\circ}C; T_1 = -40^{\circ}C; T_2 = 150^{\circ}C$$

<sup>3</sup> Final magnetic parameters will be covered in the PPAP documentation set, the table below is based on theoretical calculations

# MLX92231-AAA-xxx

## 3-Wire Hall Effect Switch

Datasheet

### 9.4 MLX92231LSE-AAA-009

DC Operating Parameters  $V_{DD} = 3.5V$  to  $24V$ ,  $T_A = -40^{\circ}C$  to  $150^{\circ}C$

Test Condition	Operating Point $B_{OP}$ (mT) <sup>(3)</sup>			Release Point $B_{RP}$ (mT) <sup>(3)</sup>			TC (ppm/°C)	Output Polarity Active Pole	Package Information
	Min	Typ <sup>(1)</sup>	Max	Min	Typ <sup>(1)</sup>	Max			
$T_A = -40^{\circ}C$	2.0	3.5	5.0	1.4	2.5	3.3	0 <sup>(2)</sup>	Z-axis sensitive Direct Switch South Pole	SE (TSOT-3L)
$T_A = 25^{\circ}C$	2.5	3.5	4.5	1.8	2.5	3.1			
$T_A = 150^{\circ}C$	2.0	3.5	5.0	1.4	2.5	3.3			

### 9.5 MLX92231LSE-AAA-010

DC Operating Parameters  $V_{DD} = 3.5V$  to  $24V$ ,  $T_A = -40^{\circ}C$  to  $150^{\circ}C$

Test Condition	Operating Point $B_{OP}$ (mT) <sup>(3)</sup>			Release Point $B_{RP}$ (mT) <sup>(3)</sup>			TC (ppm/°C)	Output Polarity Active Pole	Package Information
	Min	Typ <sup>(1)</sup>	Max	Min	Typ <sup>(1)</sup>	Max			
$T_A = -40^{\circ}C$	8.7	10.7	13.4	6.8	9.0	11.5	-1100 <sup>(2)</sup>	Z-axis sensitive Direct Switch South Pole	SE (TSOT-3L)
$T_A = 25^{\circ}C$	8.3	10.0	11.8	6.8	8.5	10.1			
$T_A = 150^{\circ}C$	6.1	8.6	11.4	4.9	7.3	9.8			

### 9.6 MLX92231LSE-AAA-013

DC Operating Parameters  $V_{DD} = 3.5V$  to  $24V$ ,  $T_A = -40^{\circ}C$  to  $150^{\circ}C$

Test Condition	Operating Point $B_{OP}$ (mT) <sup>(3)</sup>			Release Point $B_{RP}$ (mT) <sup>(3)</sup>			TC (ppm/°C)	Output Polarity Active Pole	Package Information
	Min	Typ <sup>(1)</sup>	Max	Min	Typ <sup>(1)</sup>	Max			
$T_A = -40^{\circ}C$	2.0	3.5	5.0	1.4	2.5	3.3	0 <sup>(2)</sup>	Z-axis sensitive Inverted Switch South Pole	SE (TSOT-3L)
$T_A = 25^{\circ}C$	2.5	3.5	4.5	1.8	2.5	3.1			
$T_A = 150^{\circ}C$	2.0	3.5	5.0	1.4	2.5	3.3			

### 9.7 MLX92231LSE-AAA-014

DC Operating Parameters  $V_{DD} = 3.5V$  to  $24V$ ,  $T_A = -40^{\circ}C$  to  $150^{\circ}C$

Test Condition	Operating Point $B_{OP}$ (mT) <sup>(3)</sup>			Release Point $B_{RP}$ (mT) <sup>(3)</sup>			TC (ppm/°C)	Output Polarity Active Pole	Package Information
	Min	Typ <sup>(1)</sup>	Max	Min	Typ <sup>(1)</sup>	Max			
$T_A = -40^{\circ}C$	3.6	6.0	8.4	1.5	3.6	6.1	-1100 <sup>(2)</sup>	Z-axis sensitive Direct Switch South Pole	SE (TSOT-3L)
$T_A = 25^{\circ}C$	3.9	5.5	7.1	2.0	3.5	5.3			
$T_A = 150^{\circ}C$	2.0	4.8	7.1	1.3	3.5	6.7			

<sup>1</sup> Typical values are defined at  $T_A = +25^{\circ}C$  and  $V_{DD} = 12V$

<sup>2</sup> Temperature coefficient is calculated using the following formula:

$$\frac{B_{OPT2} - B_{OPT1}}{B_{OP25^{\circ}C}} \times (T_2 - T_1) * 10^6, ppm/^{\circ}C; T_1 = -40^{\circ}C; T_2 = 150^{\circ}C$$

<sup>3</sup> Final magnetic parameters will be covered in the PPAP documentation set, the table below is based on theoretical calculations



# MLX92231-AAA-xxx

## 3-Wire Hall Effect Switch

Datasheet

### 9.8 MLX92231LSE-AAA-019

DC Operating Parameters  $V_{DD} = 3.5V$  to  $24V$ ,  $T_A = -40^{\circ}C$  to  $150^{\circ}C$

Test Condition	Operating Point $B_{OP}$ (mT) <sup>(3)</sup>			Release Point $B_{RP}$ (mT) <sup>(3)</sup>			TC (ppm/°C)	Output Polarity Active Pole	Package Information
	Min	Typ <sup>(1)</sup>	Max	Min	Typ <sup>(1)</sup>	Max			
$T_A = -40^{\circ}C$	21.5	26.0	31.0	19.0	24.0	28.5	-2000 <sup>(2)</sup>	Z-axis sensitive Direct Switch South Pole	SE (TSOT-3L)
$T_A = 25^{\circ}C$	20.0	23.0	26.0	17.5	21.0	24.0			
$T_A = 150^{\circ}C$	13.0	17.0	22.0	12.0	15.0	20.0			

### 9.9 MLX92231LSE-AAA-021

DC Operating Parameters  $V_{DD} = 3.5V$  to  $24V$ ,  $T_A = -40^{\circ}C$  to  $150^{\circ}C$

Test Condition	Operating Point $B_{OP}$ (mT) <sup>(3)</sup>			Release Point $B_{RP}$ (mT) <sup>(3)</sup>			TC (ppm/°C)	Output Polarity Active Pole	Package Information
	Min	Typ <sup>(1)</sup>	Max	Min	Typ <sup>(1)</sup>	Max			
$T_A = -40^{\circ}C$	4.3	5.9	7.7	2.1	3.8	5.4	-1100 <sup>(2)</sup>	Z-axis sensitive Inverted Switch South Pole	SE (TSOT-3L)
$T_A = 25^{\circ}C$	3.8	5.5	7.2	2.0	3.5	5.0			
$T_A = 150^{\circ}C$	3.2	4.8	6.8	1.7	3.0	5.2			

### 9.10 MLX92231LSE-AAA-023

DC Operating Parameters  $V_{DD} = 3.5V$  to  $24V$ ,  $T_A = -40^{\circ}C$  to  $150^{\circ}C$

Test Condition	Operating Point $B_{OP}$ (mT) <sup>(3)</sup>			Release Point $B_{RP}$ (mT) <sup>(3)</sup>			TC (ppm/°C)	Output Polarity Active Pole	Package Information
	Min	Typ <sup>(1)</sup>	Max	Min	Typ <sup>(1)</sup>	Max			
$T_A = -40^{\circ}C$	39.0	46.1	53.9	36.3	44.1	52.5	-1100 <sup>(2)</sup>	Z-axis sensitive Direct Switch South Pole	SE (TSOT-3L)
$T_A = 25^{\circ}C$	38.5	43.0	47.5	35.9	41.0	46			
$T_A = 150^{\circ}C$	28.8	37.1	46.5	25.6	35.0	45.1			

### 9.11 MLX92231LSE-AAA-026

DC Operating Parameters  $V_{DD} = 3.5V$  to  $24V$ ,  $T_A = -40^{\circ}C$  to  $150^{\circ}C$

Test Condition	Operating Point $B_{OP}$ (mT) <sup>(3)</sup>			Release Point $B_{RP}$ (mT) <sup>(3)</sup>			TC (ppm/°C)	Output Polarity Active Pole	Package Information
	Min	Typ <sup>(1)</sup>	Max	Min	Typ <sup>(1)</sup>	Max			
$T_A = -40^{\circ}C$	21.5	26.0	31.0	19.0	24.0	28.5	-2000 <sup>(2)</sup>	Z-axis sensitive Inverted Switch South Pole	SE (TSOT-3L)
$T_A = 25^{\circ}C$	20.0	23.0	26.0	17.5	21.0	24.0			
$T_A = 150^{\circ}C$	13.0	17.0	22.0	12.0	15.0	20.0			

<sup>1</sup> Typical values are defined at  $T_A = +25^{\circ}C$  and  $V_{DD} = 12V$

<sup>2</sup> Temperature coefficient is calculated using the following formula:

$$\frac{B_{OPT2} - B_{OPT1}}{B_{OP25^{\circ}C}} \times (T_2 - T_1) \times 10^6, \text{ ppm}/^{\circ}C; T_1 = -40^{\circ}C; T_2 = 150^{\circ}C$$

<sup>3</sup> Final magnetic parameters will be covered in the PPAP documentation set, the table below is based on theoretical calculations

# MLX92231-AAA-xxx

## 3-Wire Hall Effect Switch

Datasheet

### 9.12 MLX92231LSE-AAA-029

DC Operating Parameters  $V_{DD} = 3.5V$  to  $24V$ ,  $T_A = -40^{\circ}C$  to  $150^{\circ}C$

Test Condition	Operating Point $B_{OP}$ (mT)			Release Point $B_{RP}$ (mT)			TC (ppm/ $^{\circ}C$ )	Output Polarity Active Pole	Package Information
	Min	Typ <sup>(1)</sup>	Max	Min	Typ <sup>(1)</sup>	Max			
$T_A = -40^{\circ}C$	13.5	16.0	18.8	12.5	15.0	17.9	-1100 <sup>(2)</sup>	Z-axis sensitive Inverted Switch South Pole	SE (TSOT-3L)
$T_A = 25^{\circ}C$	13.3	15.0	16.7	12.3	14.0	15.7			
$T_A = 150^{\circ}C$	10.2	13.0	16.0	9.1	12.0	15.0			

### 9.13 MLX92231LSE-AAA-031

DC Operating Parameters  $V_{DD} = 3.5V$  to  $24V$ ,  $T_A = -40^{\circ}C$  to  $150^{\circ}C$

Test Condition	Operating Point $B_{OP}$ (mT)			Release Point $B_{RP}$ (mT)			TC (ppm/ $^{\circ}C$ )	Output Polarity Active Pole	Package Information
	Min	Typ <sup>(1)</sup>	Max	Min	Typ <sup>(1)</sup>	Max			
$T_A = -40^{\circ}C$	-17.5	-13.5	-10.0	-12.0	-8.5	-5.7	0 <sup>(2)</sup>	Z-axis sensitive Direct Switch North Pole	SE (TSOT-3L)
$T_A = 25^{\circ}C$	-17.5	-13.5	-10.0	-12.0	-8.5	-5.7			
$T_A = 150^{\circ}C$	-17.5	-13.5	-10.0	-12.0	-8.5	-5.7			

### 9.14 MLX92231LSE-AAA-032

DC Operating Parameters  $V_{DD} = 3.5V$  to  $24V$ ,  $T_A = -40^{\circ}C$  to  $150^{\circ}C$

Test Condition	Operating Point $B_{OP}$ (mT) <sup>(3)</sup>			Release Point $B_{RP}$ (mT) <sup>(3)</sup>			TC (ppm/ $^{\circ}C$ )	Output Polarity Active Pole	Package Information
	Min	Typ <sup>(1)</sup>	Max	Min	Typ <sup>(1)</sup>	Max			
$T_A = -40^{\circ}C$	20.4	24.6	29.4	17.7	22.6	27.9	-1100 <sup>(2)</sup>	Z-axis sensitive Direct Switch South Pole	SE (TSOT-3L)
$T_A = 25^{\circ}C$	20.2	23.0	25.9	17.6	21.0	24.4			
$T_A = 150^{\circ}C$	15.4	19.8	25	12.6	17.7	23.5			

### 9.15 MLX92231LSE-AAA-033

DC Operating Parameters  $V_{DD} = 3.5V$  to  $24V$ ,  $T_A = -40^{\circ}C$  to  $150^{\circ}C$

Test Condition	Operating Point $B_{OP}$ (mT) <sup>(3)</sup>			Release Point $B_{RP}$ (mT) <sup>(3)</sup>			TC (ppm/ $^{\circ}C$ )	Output Polarity Active Pole	Package Information
	Min	Typ <sup>(1)</sup>	Max	Min	Typ <sup>(1)</sup>	Max			
$T_A = -40^{\circ}C$							-1100 <sup>(2)</sup>	Z-axis sensitive Direct Switch South Pole	SE (TSOT-3L)
$T_A = 25^{\circ}C$	18			12.5					
$T_A = 150^{\circ}C$									

<sup>1</sup> Typical values are defined at  $T_A = +25^{\circ}C$  and  $V_{DD} = 12V$

<sup>2</sup> Temperature coefficient is calculated using the following formula:

$$\frac{B_{OPT2} - B_{OPT1}}{B_{OP25^{\circ}C}} \times (T_2 - T_1) * 10^6, ppm/^{\circ}C; T_1 = -40^{\circ}C; T_2 = 150^{\circ}C$$

<sup>3</sup> Final magnetic parameters will be covered in the PPAP documentation set, the table below is based on theoretical calculations

# MLX92231-AAA-xxx

## 3-Wire Hall Effect Switch

Datasheet

### 9.16 MLX92231LUA-AAA-034

DC Operating Parameters  $V_{DD} = 3.5V$  to  $24V$ ,  $T_A = -40^{\circ}C$  to  $150^{\circ}C$

Test Condition	Operating Point $B_{OP}$ (mT) <sup>(3)</sup>			Release Point $B_{RP}$ (mT) <sup>(3)</sup>			TC (ppm/°C)	Output Polarity Active Pole	Package Information
	Min	Typ <sup>(1)</sup>	Max	Min	Typ <sup>(1)</sup>	Max			
$T_A = -40^{\circ}C$	4.3	5.9	7.7	2.1	3.8	5.4	-1100 <sup>(2)</sup>	Z-axis sensitive Direct Switch South Pole	UA (TO92-3)
$T_A = 25^{\circ}C$	3.8	5.5	7.2	2	3.5	5			
$T_A = 150^{\circ}C$	3.2	4.8	6.8	1.7	3	5.2			

### 9.17 MLX92231LUA-AAA-039

DC Operating Parameters  $V_{DD} = 3.5V$  to  $24V$ ,  $T_A = -40^{\circ}C$  to  $150^{\circ}C$

Test Condition	Operating Point $B_{OP}$ (mT) <sup>(3)</sup>			Release Point $B_{RP}$ (mT) <sup>(3)</sup>			TC (ppm/°C)	Output Polarity Active Pole	Package Information
	Min	Typ <sup>(1)</sup>	Max	Min	Typ <sup>(1)</sup>	Max			
$T_A = -40^{\circ}C$	10.0	13.5	17.4	5.7	8.5	12.0	0 <sup>(2)</sup>	Z-axis sensitive Direct Switch South Pole	UA (TO92-3)
$T_A = 25^{\circ}C$	10.0	13.5	17.4	5.7	8.5	12.0			
$T_A = 150^{\circ}C$	10.0	13.5	17.4	5.7	8.5	12.0			

### 9.18 MLX92231LSE-AAA-040

DC Operating Parameters  $V_{DD} = 3.5V$  to  $24V$ ,  $T_A = -40^{\circ}C$  to  $150^{\circ}C$

Test Condition	Operating Point $B_{OP}$ (mT) <sup>(3)</sup>			Release Point $B_{RP}$ (mT) <sup>(3)</sup>			TC (ppm/°C)	Output Polarity Active Pole	Package Information
	Min	Typ <sup>(1)</sup>	Max	Min	Typ <sup>(1)</sup>	Max			
$T_A = -40^{\circ}C$							-1100 <sup>(2)</sup>	Z-axis sensitive Direct Switch South Pole	SE (TSOT-3L)
$T_A = 25^{\circ}C$	66.0			50.0					
$T_A = 150^{\circ}C$									

### 9.19 MLX92231LSE-AAA-041

DC Operating Parameters  $V_{DD} = 3.5V$  to  $24V$ ,  $T_A = -40^{\circ}C$  to  $150^{\circ}C$

Test Condition	Operating Point $B_{OP}$ (mT) <sup>(3)</sup>			Release Point $B_{RP}$ (mT) <sup>(3)</sup>			TC (ppm/°C)	Output Polarity Active Pole	Package Information
	Min	Typ <sup>(1)</sup>	Max	Min	Typ <sup>(1)</sup>	Max			
$T_A = -40^{\circ}C$							-1100 <sup>(2)</sup>	Z-axis sensitive Direct Switch South Pole	SE (TSOT-3L)
$T_A = 25^{\circ}C$	10.2			8.4					
$T_A = 150^{\circ}C$									

<sup>1</sup> Typical values are defined at  $T_A = +25^{\circ}C$  and  $V_{DD} = 12V$

<sup>2</sup> Temperature coefficient is calculated using the following formula:

$$\frac{B_{OPT2} - B_{OPT1}}{B_{OP25^{\circ}C}} \times (T_2 - T_1) * 10^6, ppm/^{\circ}C; T_1 = -40^{\circ}C; T_2 = 150^{\circ}C$$

<sup>3</sup> Final magnetic parameters will be covered in the PPAP documentation set, the table below is based on theoretical calculations

# MLX92231-AAA-xxx

## 3-Wire Hall Effect Switch

Datasheet

### 9.20 MLX92231LSE-AAA-042

DC Operating Parameters  $V_{DD} = 3.5V$  to  $24V$ ,  $T_A = -40^{\circ}C$  to  $150^{\circ}C$

Test Condition	Operating Point $B_{OP}$ (mT) <sup>(3)</sup>			Release Point $B_{RP}$ (mT) <sup>(3)</sup>			TC (ppm/°C)	Output Polarity Active Pole	Package Information
	Min	Typ <sup>(1)</sup>	Max	Min	Typ <sup>(1)</sup>	Max			
$T_A = -40^{\circ}C$							-1100 <sup>(2)</sup>	Z-axis sensitive Direct Switch South Pole	SE (TSOT-3L)
$T_A = 25^{\circ}C$	51.2			41					
$T_A = 150^{\circ}C$									

### 9.21 MLX92231LSE-AAA-049

DC Operating Parameters  $V_{DD} = 3.5V$  to  $24V$ ,  $T_A = -40^{\circ}C$  to  $150^{\circ}C$

Test Condition	Operating Point $B_{OP}$ (mT) <sup>(3)</sup>			Release Point $B_{RP}$ (mT) <sup>(3)</sup>			TC (ppm/°C)	Output Polarity Active Pole	Package Information
	Min	Typ <sup>(1)</sup>	Max	Min	Typ <sup>(1)</sup>	Max			
$T_A = -40^{\circ}C$	13.5	16.0	18.8	12.5	15.0	17.9	-1100 <sup>(2)</sup>	Z-axis sensitive Direct Switch South Pole	SE (TSOT-3L)
$T_A = 25^{\circ}C$	13.3	15.0	16.7	12.3	14.0	15.7			
$T_A = 150^{\circ}C$	10.2	13.0	16.0	9.1	12.0	15.0			

### 9.22 MLX92231LSE-AAA-204

DC Operating Parameters  $V_{DD} = 3.5V$  to  $24V$ ,  $T_A = -40^{\circ}C$  to  $150^{\circ}C$

Test Condition	Operating Point $B_{OP}$ (mT)			Release Point $B_{RP}$ (mT)			TC (ppm/°C)	Output Polarity Active Pole	Package Information
	Min	Typ <sup>(1)</sup>	Max	Min	Typ <sup>(1)</sup>	Max			
$T_A = -40^{\circ}C$	4.7	7.0	9.4	3.5	6.2	9.0	-1100 <sup>(2)</sup>	X-axis sensitive Inverted Switch South Pole	SE (TSOT-3L)
$T_A = 25^{\circ}C$	4.4	6.5	8.7	3.2	5.6	8.1			
$T_A = 150^{\circ}C$	3.4	5.5	7.8	2.2	4.6	7.3			

<sup>1</sup> Typical values are defined at  $T_A = +25^{\circ}C$  and  $V_{DD} = 12V$

<sup>2</sup> Temperature coefficient is calculated using the following formula:

$$\frac{B_{OPT2} - B_{OPT1}}{B_{OP25^{\circ}C}} \times (T_2 - T_1) * 10^6, ppm/^{\circ}C; T_1 = -40^{\circ}C; T_2 = 150^{\circ}C$$

<sup>3</sup> Final magnetic parameters will be covered in the PPAP documentation set, the table below is based on theoretical calculations

# MLX92231-AAA-xxx

## 3-Wire Hall Effect Switch

Datasheet

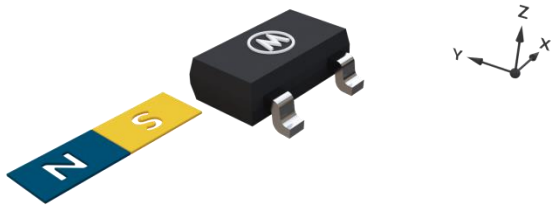

*South active pole (IMC version)*

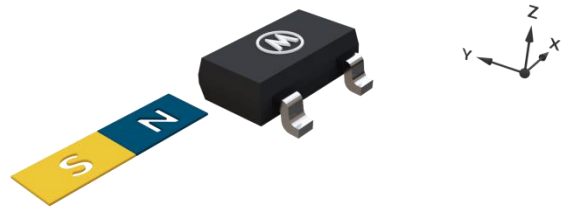

*North active pole (IMC version)*

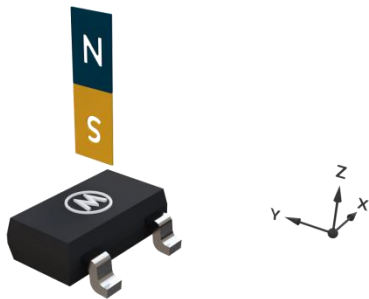

*South active pole*

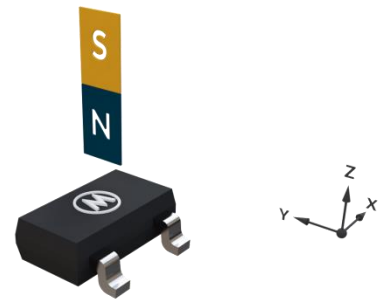

*North active pole*

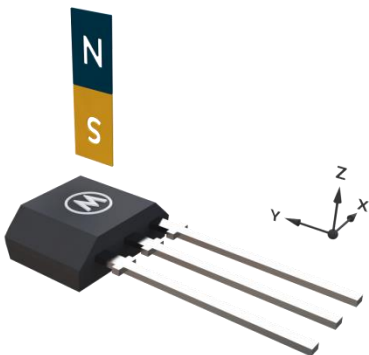

*South active pole*

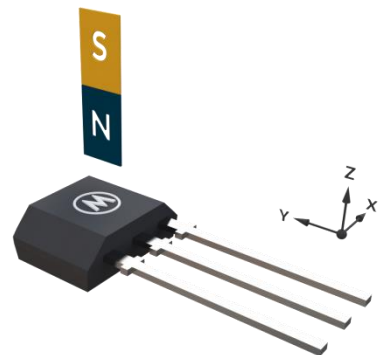

*North active pole*

## 10 Magnetic Behaviour

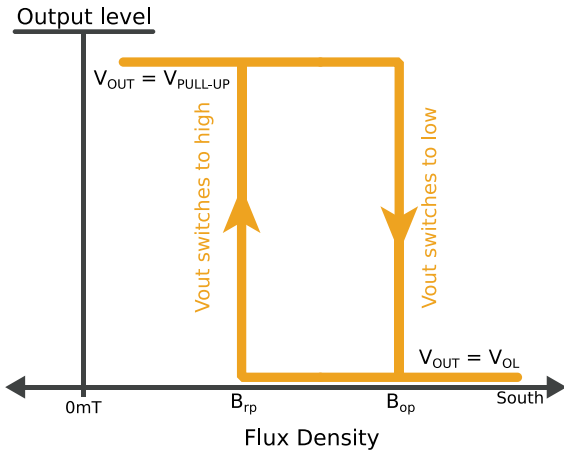

Direct South Active Pole

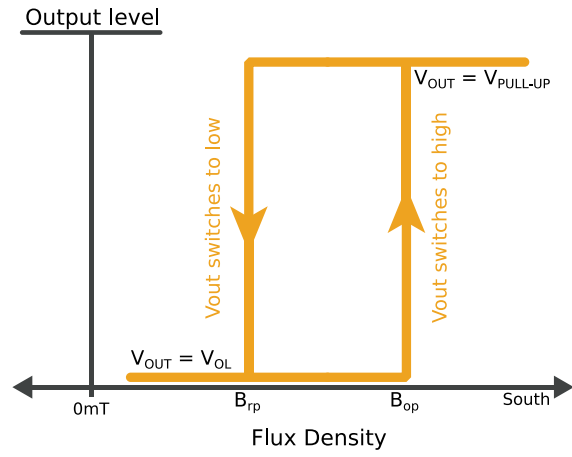

Inverted South Active Pole

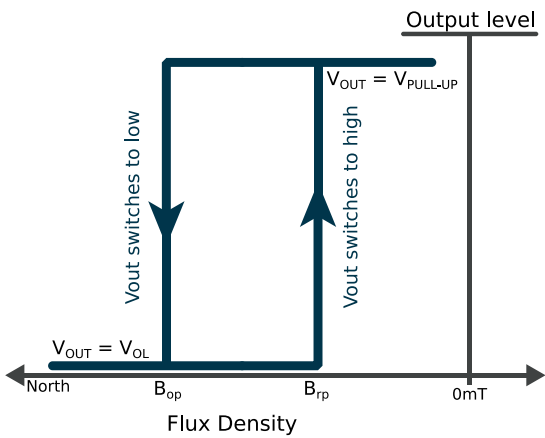

Direct North Active Pole

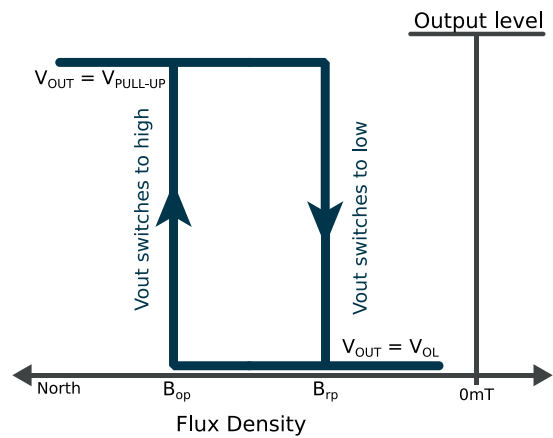

Inverted North Active Pole

## 11 Application Information

### 11.1 Typical Three-Wire Application Circuit

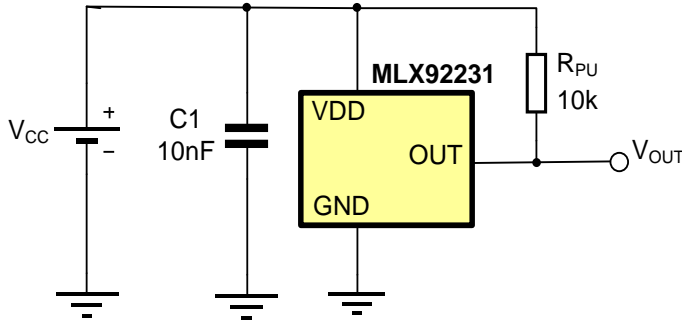

**Notes:**

1. For proper operation, a 10nF to 100nF bypass capacitor should be placed as close as possible to the V<sub>DD</sub> and ground pin.
2. The pull-up resistor R<sub>PU</sub> value should be chosen in to limit the current through the output pin below the maximum allowed continuous current for the device.
3. A capacitor connected to the output is not needed, because the output slope is generated internally.

### 11.2 Automotive and Harsh, Noisy Environments Three-Wire Circuit

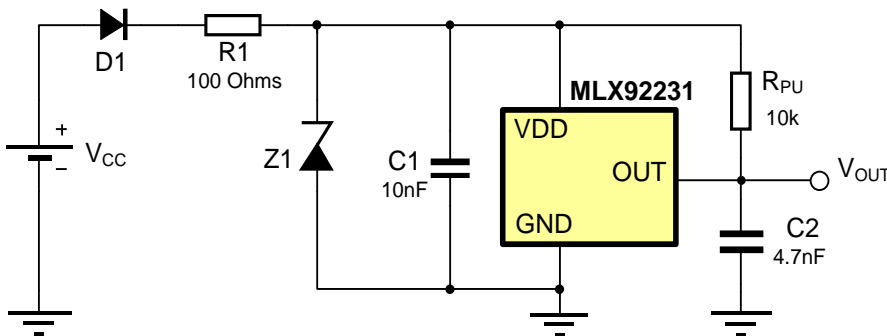

**Notes:**

1. For proper operation, a 10nF to 100nF bypass capacitor should be placed as close as possible to the V<sub>DD</sub> and ground pin.
2. The device could tolerate negative voltage down to -24V, so if negative transients over supply line V<sub>PEAK</sub> < -30V are expected, usage of the diode D1 is recommended. Otherwise only R1 is sufficient.

When selecting the resistor R1, three points are important:

- the resistor has to limit I<sub>DD</sub>/I<sub>DDREV</sub> to 50mA maximum
- the resistor has to withstand the power dissipated in both over voltage conditions ( $V_{R1}^2/R1$ )
- the resulting device supply voltage V<sub>DD</sub> has to be higher than V<sub>DD</sub> min ( $V_{DD} = V_{CC} - R1 \cdot I_{DD}$ )

3. The device could tolerate positive supply voltage up to +27V (until the maximum power dissipation is not exceeded), so if positive transients over supply line with V<sub>PEAK</sub> > 32V are expected, usage a zener diode Z1 is recommended. The R1-Z1 network should be sized to limit the voltage over the device below the maximum allowed.

## 12 Standard information regarding manufacturability of Melexis products with different soldering processes

Our products are classified and qualified regarding soldering technology, solderability and moisture sensitivity level according to following test methods:

### Reflow Soldering SMD's (Surface Mount Device)s

- IPC/JEDEC J-STD-020  
Moisture/Reflow Sensitivity Classification for Nonhermetic Solid State Surface Mount Devices (classification reflow profiles according to table 5-2)
- EIA/JEDEC JESD22-A113  
Preconditioning of Nonhermetic Surface Mount Devices Prior to Reliability Testing (reflow profiles according to table 2)

### Wave Soldering SMD's (Surface Mount Device)s and THD's (Through Hole Device)s

- EN60749-20  
Resistance of plastic- encapsulated SMD's to combined effect of moisture and soldering heat
- EIA/JEDEC JESD22-B106 and EN60749-15  
Resistance to soldering temperature for through-hole mounted devices

### Iron Soldering THD's (Through Hole Device)s

- EN60749-15  
Resistance to soldering temperature for through-hole mounted devices

### Solderability SMD's (Surface Mount Device)s and THD's (Through Hole Device)s

- EIA/JEDEC JESD22-B102 and EN60749-21  
Solderability

For all soldering technologies deviating from above mentioned standard conditions (regarding peak temperature, temperature gradient, temperature profile etc) additional classification and qualification tests have to be agreed upon with Melexis.

The application of Wave Soldering for SMD's is allowed only after consulting Melexis regarding assurance of adhesive strength between device and board.

Melexis is contributing to global environmental conservation by promoting **lead free** solutions. For more information on qualifications of **RoHS** compliant products (RoHS = European directive on the Restriction Of the use of certain Hazardous Substances) please visit the quality page on our website: <http://www.melexis.com/quality.aspx>

## 13 ESD Precautions

Electronic semiconductor products are sensitive to Electro Static Discharge (ESD).

Always observe Electro Static Discharge control procedures whenever handling semiconductor products.



## 14 Package Information

### 14.1 SE (TSOT-3L) Package Information

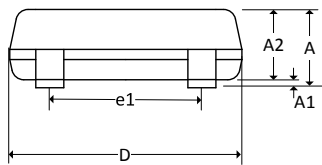
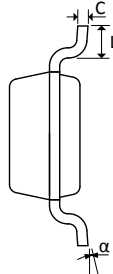
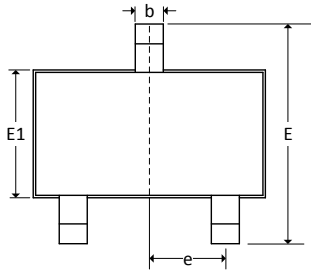

**Marking:**

Top mark: 31ww ==> ww; assembly week

IMC version: 33ww ==> ww; assembly week

Bottom mark: YLLL ==> Y; last digit of year LLL= last 3 digits of lot number

**Hall plate location**

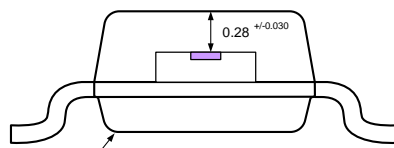
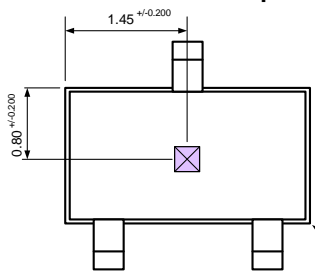

**Notes:**

1. All dimensions are in millimeters
2. XY Hall plate position tolerances do not include the mold flashes and protrusions described in the package drawing

**TOP VIEW**

**END VIEW**

	A	A1	A2	D	E	E1	L	b	c	e	e1	α
min	—	0.025	0.85	2.80	2.60	1.50	0.30	0.30	0.10	0.95	1.90	0°
max	1.00	0.10	0.90	3.00	3.00	1.70	0.50	0.45	0.20	BSC	BSC	8°

**Notes:**

1. All dimensions are in millimetres.
2. Dimension “D” and “E1” do not include mold flash or protrusions. Mold flash or protrusion shall not exceed 0.15mm on “D” and 0.25mm on “E” per side.
3. Dimension “b” does not include dambar protrusion.

SE Pin №	Name	Type	Function
1	VDD	Supply	Supply Voltage pin
2	OUT	Output	Open Drain output
3	GND	Ground	Ground pin

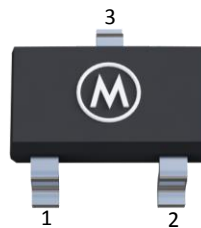

*SE Package pinout*

# MLX92231-AAA-xxx

## 3-Wire Hall Effect Switch

Datasheet

### 14.2 UA (TO92-3L) Package Information

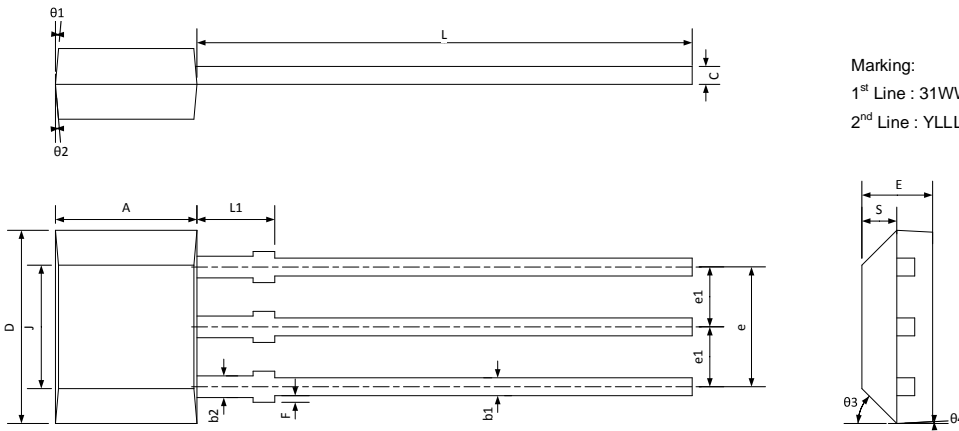

Marking:  
 1<sup>st</sup> Line : 31WW → WW - calendar week  
 2<sup>nd</sup> Line : YLLL → Y - last digit of year  
 LLL - Lot number (3 digits)

#### Hall plate location

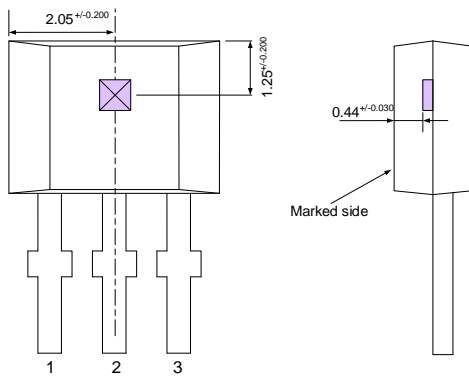

**Notes:**  
 1. All dimensions are in millimeters

	A	D	E	F	J	L	L1	S	b1	b2	c	e	e1
min	2.80	3.90	1.40	0.00	2.51	14.0	0.90	0.63	0.35	0.43	0.35	2.51	1.24
max	3.20	4.30	1.60	0.20	2.72	15.0	1.10	0.84	0.44	0.52	0.44	2.57	1.30
	theta1	theta2	theta3	theta4									
min	7° REF	7° REF	45° REF	7° REF									
max													

**Notes:**

1. All dimensions are in millimetres
2. Mold flashes and protrusion are not included.
3. Gate burrs shall not exceed 0.127mm on the top side.

UA Pin №	Name	Type	Function
1	VDD	Supply	Supply Voltage pin
2	GND	Ground	Ground pin
3	OUT	Output	Open Drain output

UA Package pinout



## 15 Contact

For the latest version of this document, go to our website at [www.melexis.com](http://www.melexis.com).

For additional information, please contact our Direct Sales team and get help for your specific needs:

Europe, Africa	Telephone: +32 13 67 04 95
	Email : sales_europe@melexis.com
Americas	Telephone: +1 603 223 2362
	Email : sales_usa@melexis.com
Asia	Email : sales_asia@melexis.com

## 16 Disclaimer

*The information furnished by Melexis herein ("Information") is believed to be correct and accurate. Melexis disclaims (i) any and all liability in connection with or arising out of the furnishing, performance or use of the technical data or use of the product(s) as described herein ("Product") (ii) any and all liability, including without limitation, special, consequential or incidental damages, and (iii) any and all warranties, express, statutory, implied, or by description, including warranties of fitness for particular purpose, non-infringement and merchantability. No obligation or liability shall arise or flow out of Melexis' rendering of technical or other services.*

*The Information is provided "as is" and Melexis reserves the right to change the Information at any time and without notice. Therefore, before placing orders and/or prior to designing the Product into a system, users or any third party should obtain the latest version of the relevant information to verify that the information being relied upon is current.*

*Users or any third party must further determine the suitability of the Product for its application, including the level of reliability required and determine whether it is fit for a particular purpose.*

*The Information is proprietary and/or confidential information of Melexis and the use thereof or anything described by the Information does not grant, explicitly or implicitly, to any party any patent rights, licenses, or any other intellectual property rights.*

*This document as well as the Product(s) may be subject to export control regulations. Please be aware that export might require a prior authorization from competent authorities.*

*The Product(s) are intended for use in normal commercial applications. Unless otherwise agreed upon in writing, the Product(s) are not designed, authorized or warranted to be suitable in applications requiring extended temperature range and/or unusual environmental requirements. High reliability applications, such as medical life-support or life-sustaining equipment are specifically not recommended by Melexis.*

*The Product(s) may not be used for the following applications subject to export control regulations: the development, production, processing, operation, maintenance, storage, recognition or proliferation of 1) chemical, biological or nuclear weapons, or for the development, production, maintenance or storage of missiles for such weapons; 2) civil firearms, including spare parts or ammunition for such arms; 3) defense related products, or other material for military use or for law enforcement; 4) any applications that, alone or in combination with other goods, substances or organisms could cause serious harm to persons or goods and that can be used as a means of violence in an armed conflict or any similar violent situation.*

*The Products sold by Melexis are subject to the terms and conditions as specified in the Terms of Sale, which can be found at <https://www.melexis.com/en/legal/terms-and-conditions>.*

*This document supersedes and replaces all prior information regarding the Product(s) and/or previous versions of this document.*

*Melexis NV © - No part of this document may be reproduced without the prior written consent of Melexis. (2016)*

*ISO/TS 16949 and ISO14001 Certified*



Компания «ЭлектроПласт» предлагает заключение долгосрочных отношений при поставках импортных электронных компонентов на взаимовыгодных условиях!

Наши преимущества:

- Оперативные поставки широкого спектра электронных компонентов отечественного и импортного производства напрямую от производителей и с крупнейших мировых складов;
- Поставка более 17-ти миллионов наименований электронных компонентов;
- Поставка сложных, дефицитных, либо снятых с производства позиций;
- Оперативные сроки поставки под заказ (от 5 рабочих дней);
- Экспресс доставка в любую точку России;
- Техническая поддержка проекта, помощь в подборе аналогов, поставка прототипов;
- Система менеджмента качества сертифицирована по Международному стандарту ISO 9001;
- Лицензия ФСБ на осуществление работ с использованием сведений, составляющих государственную тайну;
- Поставка специализированных компонентов (Xilinx, Altera, Analog Devices, Intersil, Interpoint, Microsemi, Aeroflex, Peregrine, Syfer, Eurofarad, Texas Instrument, Miteq, Cobham, E2V, MA-COM, Hittite, Mini-Circuits, General Dynamics и др.);

Помимо этого, одним из направлений компании «ЭлектроПласт» является направление «Источники питания». Мы предлагаем Вам помощь Конструкторского отдела:

- Подбор оптимального решения, техническое обоснование при выборе компонента;
- Подбор аналогов;
- Консультации по применению компонента;
- Поставка образцов и прототипов;
- Техническая поддержка проекта;
- Защита от снятия компонента с производства.



#### Как с нами связаться

**Телефон:** 8 (812) 309 58 32 (многоканальный)

**Факс:** 8 (812) 320-02-42

**Электронная почта:** [org@eplast1.ru](mailto:org@eplast1.ru)

**Адрес:** 198099, г. Санкт-Петербург, ул. Калинина, дом 2, корпус 4, литера А.