

SPDT SWITCH GaAs MMIC

■GENERAL DESCRIPTION

NJG1523KB2 is a SPDT switch IC featured low insertion loss, medium handling power and high isolation.

This device is suitable for switching of Tx/Rx signals at sub-microwave applications.

This switch exhibits wide frequency range from 50MHz to 3.0GHz at low operating voltage of 2.5V, and is operated up to 25dBm at 3.0V operating voltage.

The ultra small & ultra thin FLP6 package is applied.

Reversed logic version of this device is NJG1533KB2.

■PACKAGE OUTLINE



NJG1523KB2

■FEATURES

- Single low voltage control +2.5~+6.5V
- Low insertion loss 0.4dB typ. @f=1GHz, P_{IN}=23dBm
0.5dB typ. @f=2GHz, P_{IN}=23dBm
- High isolation 29dB typ. @f=2GHz, P_{IN}=23dBm
- Handling power 25dBm max. @f=2GHz, V_{CTL}=3.0V
- Low current consumption 8uA typ. @f=0.05~2.5GHz, P_{IN}=23dBm
- Ultra small & ultra thin package FLP6-B2 (Package size: 2.0x2.1x0.75mm)

■PIN CONFIGURATION

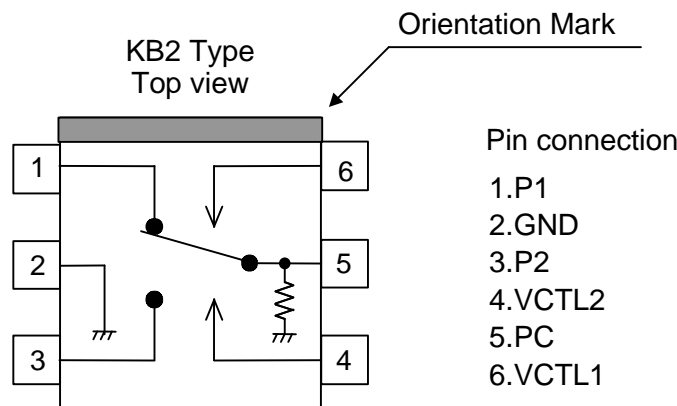

■TRUTH TABLE

“ H ” =V_{CTL (H)}, “ L ” =V_{CTL (L)}

VCTL1	H	L	L	H
VCTL2	L	H	L	H
PC – P1	ON	OFF	Insertion loss=17dB P1 return Loss=2dB	Insertion loss=18dB P1 return Loss=2dB
PC – P2	OFF	ON	Insertion loss=17dB P2 return Loss=2dB	Insertion loss=18dB P2 return Loss=2dB

Note: Reversed logic version of this device is NJG1533KB2.
The values of insertion losses and return losses are the typical values at 2GHz.

NJG1523KB2

■ABSOLUTE MAXIMUM RATINGS

				(T _a =25°C)
PARAMETER	SYMBOL	CONDITIONS	RATINGS	UNITS
Input Power	P _{in}	V _{CTL(L)} =0V, V _{CTL(H)} =2.7V	32	dBm
Control Voltage	V _{CTL}	V _{CTL(H)} -V _{CTL(L)}	7.5	V
Power Dissipation	P _D		450	mW
Operating Temp.	T _{opr}		-30~+85	°C
Storage Temp.	T _{stg}		-55~+125	°C

■ELECTRICAL CHARACTERISTICS

							(V _{CTL(L)} =0V, V _{CTL(H)} =2.7V, Z _S =Z _L =50Ω, T _a =25°C)
PARAMETERS	SYMBOL	CONDITIONS	MIN	TYP	MAX	UNITS	
Operating voltage (LOW)	V _{CTL(L)}		-0.2	0	0.2	V	
Operating voltage (HIGH)	V _{CTL(H)}		2.5	2.7	6.5	V	
Control current	I _{CTL}	f=2.0GHz, P _{IN} =23dBm	-	8	14	uA	
Insertion loss 1	LOSS1	f=1.0GHz, P _{IN} =23dBm	-	0.4	0.7	dB	
Insertion loss 2	LOSS2	f=2.0GHz, P _{IN} =23dBm	-	0.5	0.8	dB	
Isolation 1 (PC-P1, PC-P2, P1-P2)	ISL1	f=1.0GHz, P _{IN} =23dBm	27	29	-	dB	
Isolation 2 (PC-P1, PC-P2, P1-P2)	ISL2	f=2.0GHz, P _{IN} =23dBm	26	29	-	dB	
Maximum input power 1*	P _{in1}	V _{CTL(H)} =2.7V, f=2GHz	-	-	24.0	dBm	
Maximum input power 2*	P _{in2}	V _{CTL(H)} =3.0V, f=2GHz	-	-	25.0	dBm	
Maximum input power 3*	P _{in3}	V _{CTL(H)} =6.5V, f=2GHz	-	-	34.5	dBm	
Pin at 1dB compression point	P _{-1dB}	f=2.0GHz	28	30.5	-	dBm	
VSWR (PC, P1, P2)	VSWR	f=0.05~2.2GHz, ON State	-	1.4	1.6		
Switching time	T _{SW}	f _{in} =0.05~2.5GHz	-	20	-	ns	

* Maximum input power: This value is defined as maximum input power of linear operating region
or damage free operating region

■ TERMINAL INFORMATION

No.	SYMBOL	DESCRIPTION
1	P1	RF port. This port is connected with PC port by controlling 6 th pin ($V_{CTL(H)}$) to 2.5~6.5V and 4 th pin ($V_{CTL(L)}$) to -0.2~+0.2V. An external capacitor is required to block the DC bias voltage of internal circuit. (50~100MHz: 0.01uF, 0.1~0.5GHz: 1000pF, 0.5~2.5GHz: 56pF)
2	GND	Ground terminal. Please connect this terminal with ground plane as close as possible for excellent RF performance.
3	P2	RF port. This port is connected with PC port by controlling 4 th pin ($V_{CTL(H)}$) to 2.5~6.5V and 6 th pin ($V_{CTL(L)}$) to -0.2~+0.2V. An external capacitor is required to block the DC bias voltage of internal circuit. (50~100MHz: 0.01uF, 0.1~0.5GHz: 1000pF, 0.5~2.5GHz: 56pF)
4	VCTL2	Control port 2. The voltage of this port controls PC to P2 state. The ' ON' and ' OFF' state is toggled by controlling voltage of this terminal such as high-state (2.5~6.5V) or low-state (-0.2~+0.2V). The voltage of 6 th pin have to be set to opposite state. The bypass capacitor has to be chosen to reduce switching time delay from 10pF~1000pF range.
5	PC	Common RF port. In order to block the DC bias voltage of internal circuit, an external capacitor is required. (50~100MHz:0.01uF, 0.1~0.5GHz: 1000pF, 0.5~2.5GHz: 56pF)
6	VCTL1	Control port 1. The voltage of this port controls PC to P2 state. The ' ON' and ' OFF' state is toggled by controlling voltage of this terminal such as high-state (2.5~6.5V) or low-state (-0.2~+0.2V). The voltage of 4 th pin have to be set to opposite state. The bypass capacitor has to be chosen to reduce switching time delay from 10pF~1000pF range.

■ ELECTRICAL CHARACTERISTICS

(f=0.1~3.0GHz, with Application circuit, Losses of external circuit are excluded)

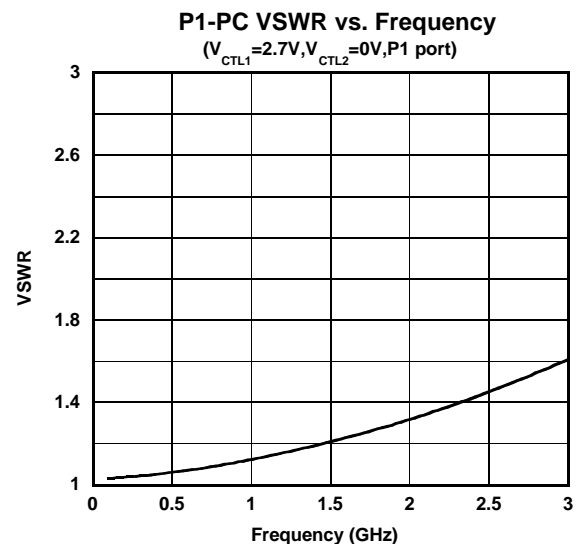
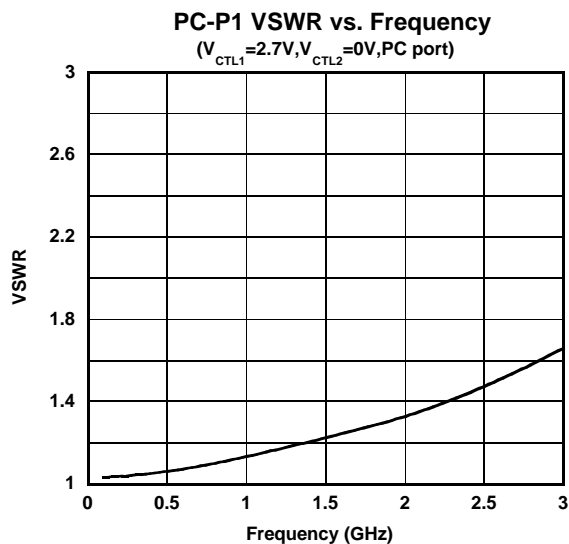
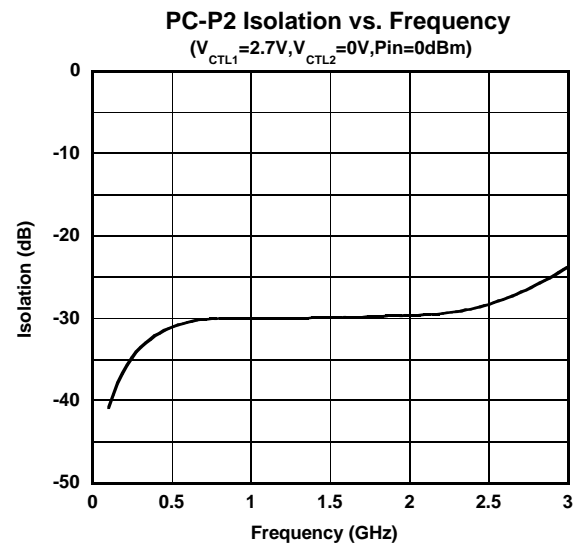
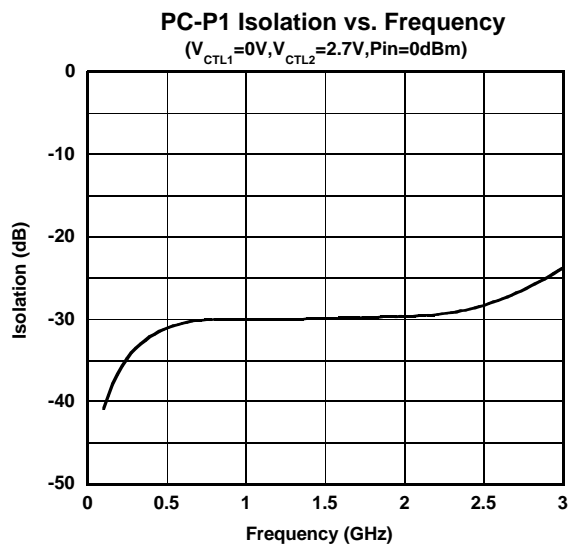
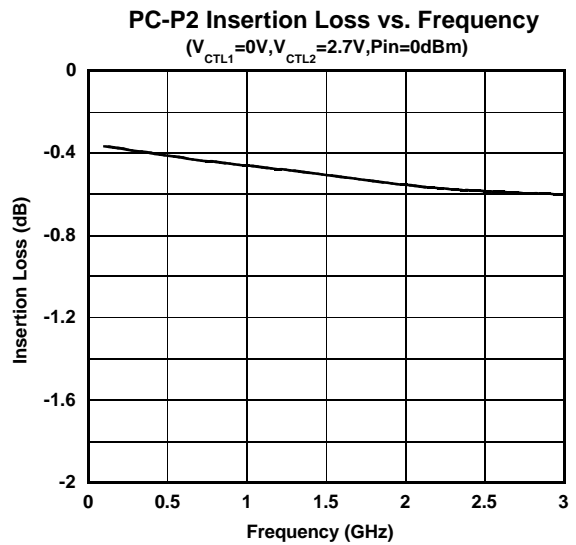
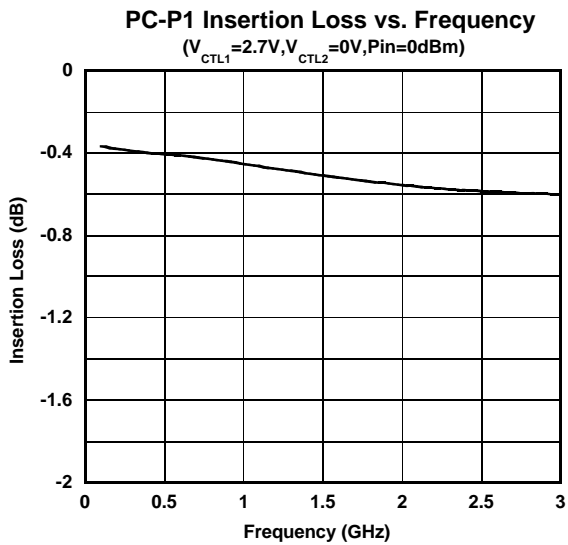

■ ELECTRICAL CHARACTERISTICS

(with application circuit, without DC Blocking Capacitor, Losses of external circuit are excluded)

P2-PC VSWR vs. Frequency

($V_{CTL1}=0V, V_{CTL2}=2.7V, P2$ port)

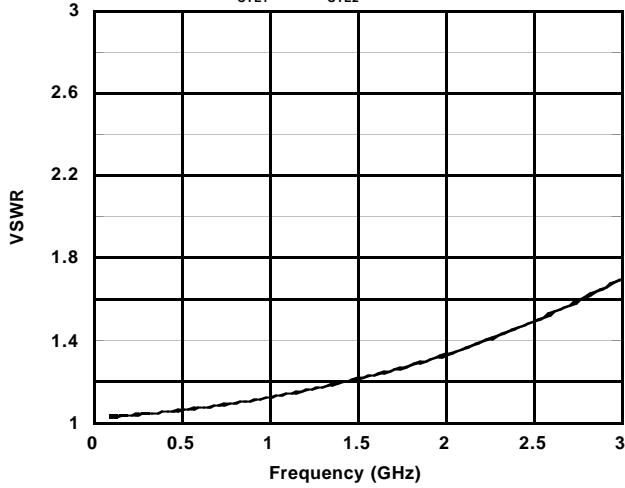

Input Power vs. Output Power, I_{CTL}

($V_{CTL(L)}=0V, V_{CTL(H)}=2.7V$)

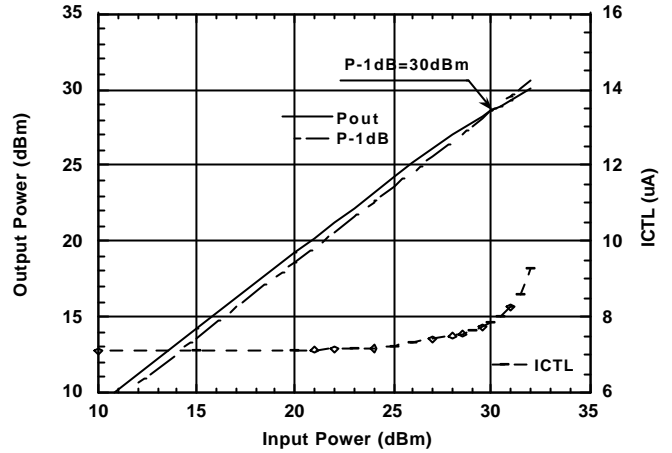

Switching Speed

($V_{CTL(L)}=0V, V_{CTL(H)}=2.7V$)

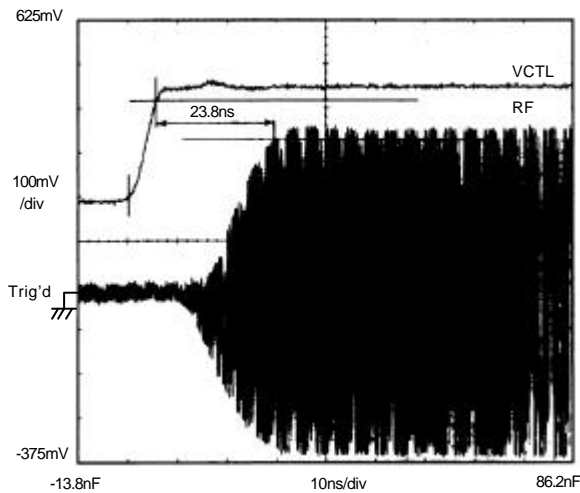

Insertion Loss vs. Ambient Temperature

(PC-P1 port, $f_{in}=1GHz, V_{CTL(L)}=0V$)

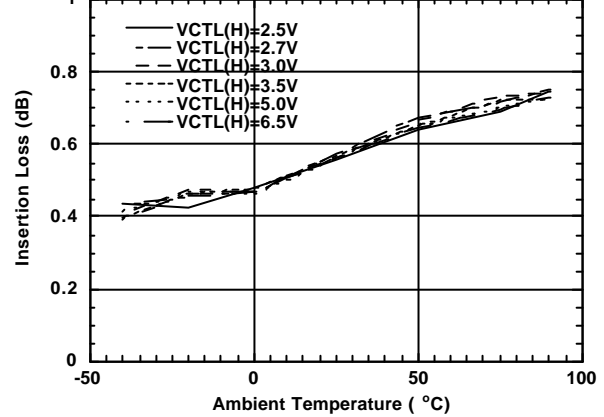

Isolation vs. Ambient Temperature

(PC-P1 port, $f_{in}=1GHz, V_{CTL(L)}=0V$)

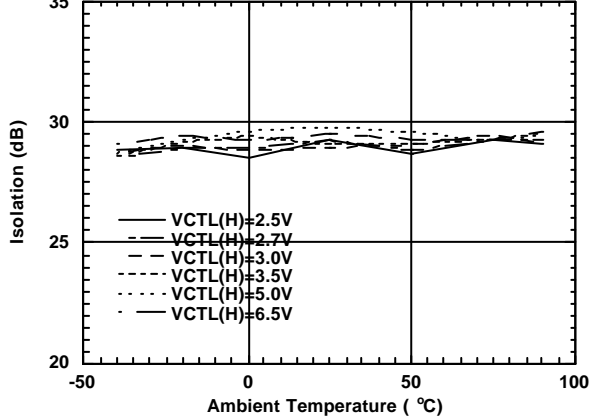

ICTL vs. Ambient Temperature

(PC-P1 port, $f_{in}=1GHz, V_{CTL(L)}=0V$)

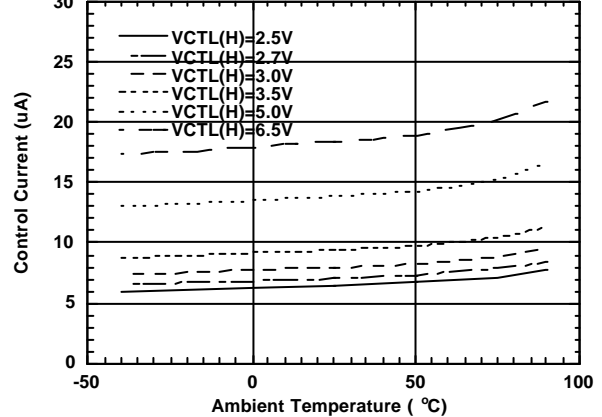

■ ELECTRICAL CHARACTERISTICS

(f=50~100MHz, with Application circuit (Parts list 1), Losses of PCB, connector and DC blocking capacitor are included)

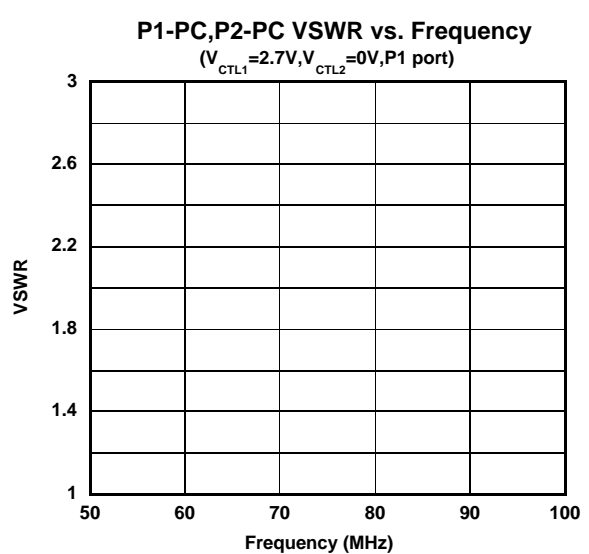
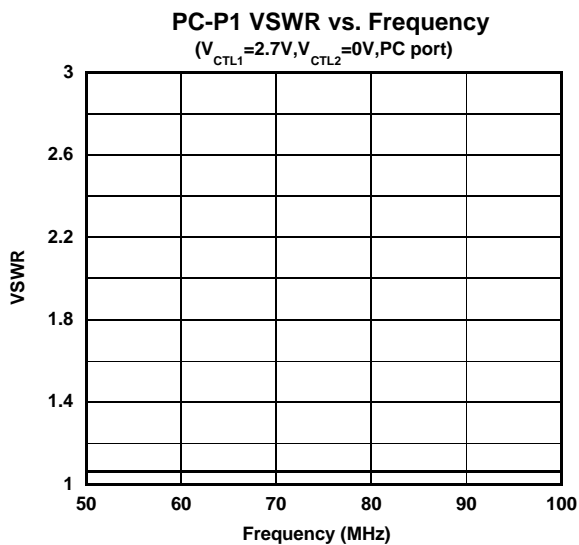
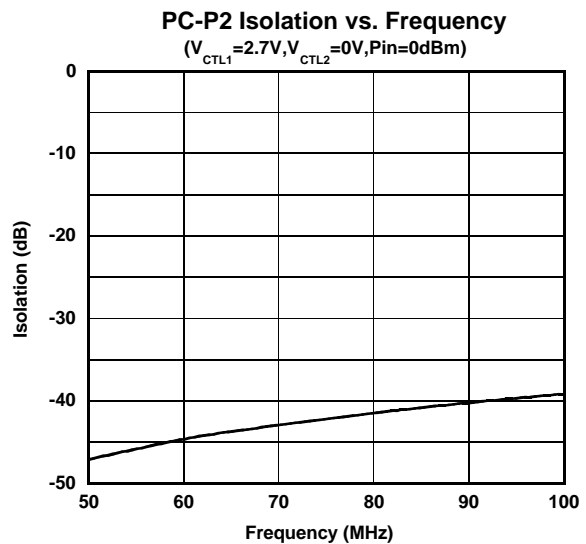
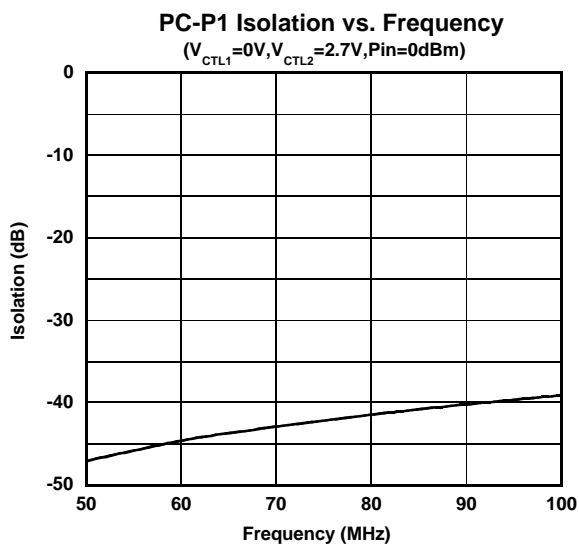
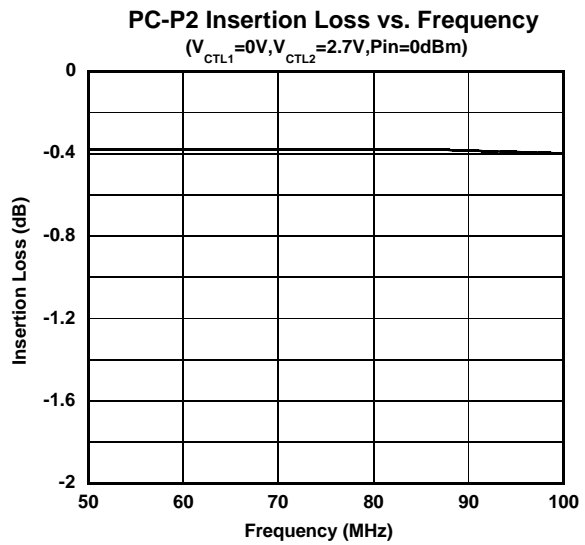
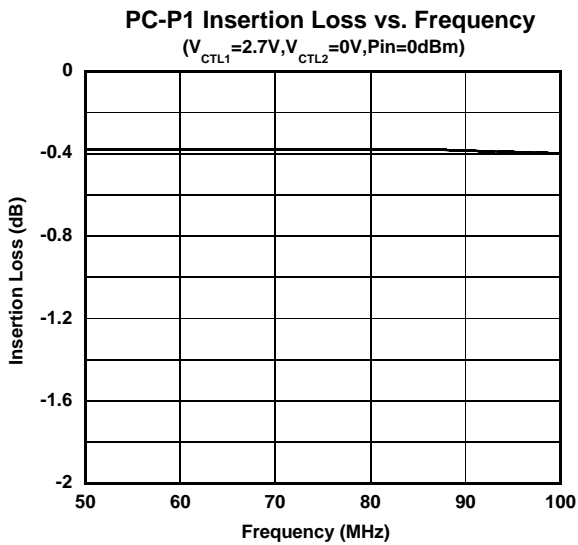

ELECTRICAL CHARACTERISTICS

(f=100-500MHz, with Application circuit (Parts list 2), Losses of PCB, connector and DC blocking capacitor are included)

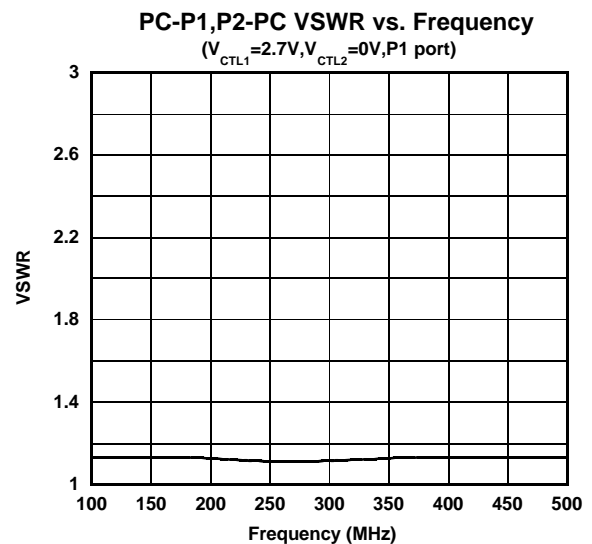
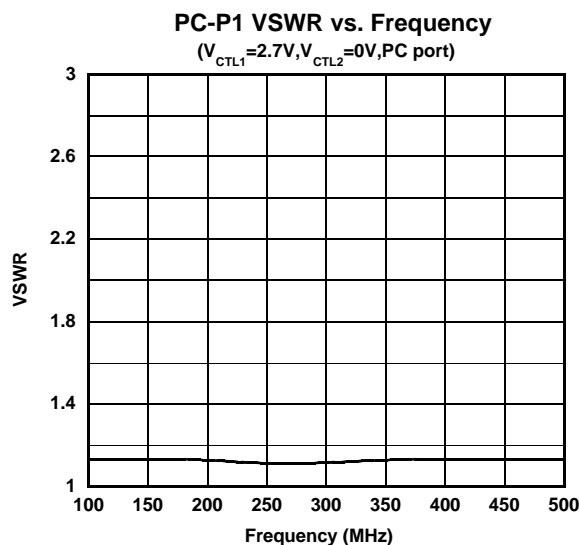
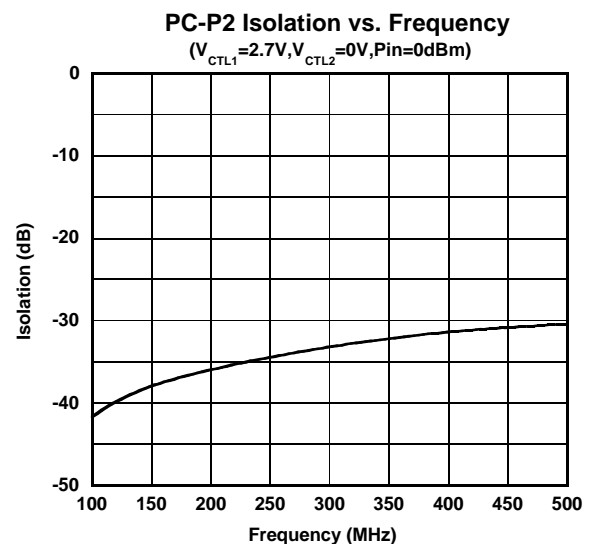
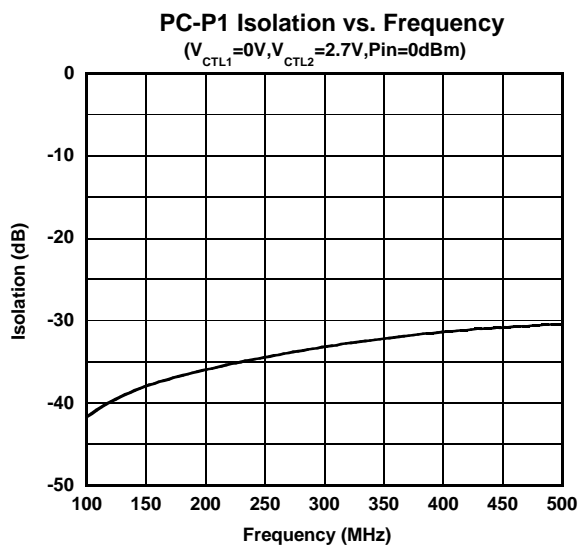
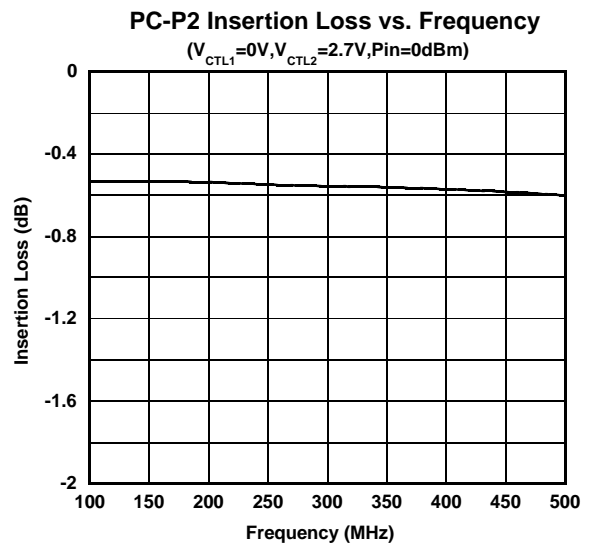
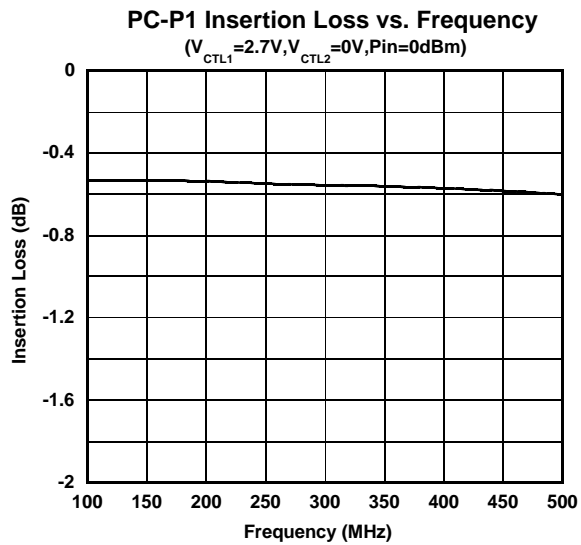

ELECTRICAL CHARACTERISTICS

(f=0.1~3.0GHz, with Application circuit (Parts list 3), Losses of PCB, connector and DC blocking capacitor are included)

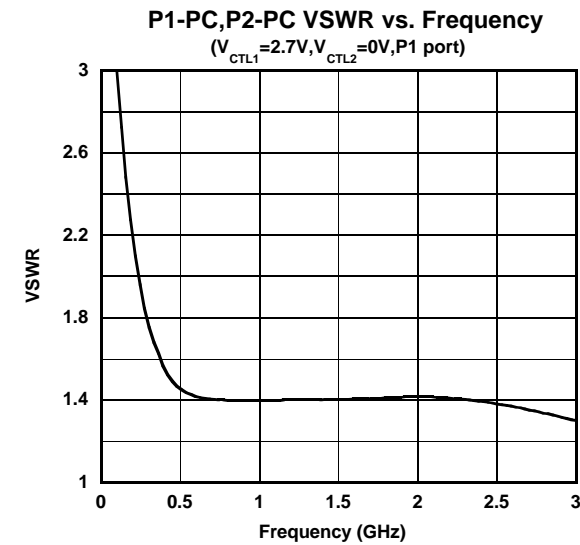
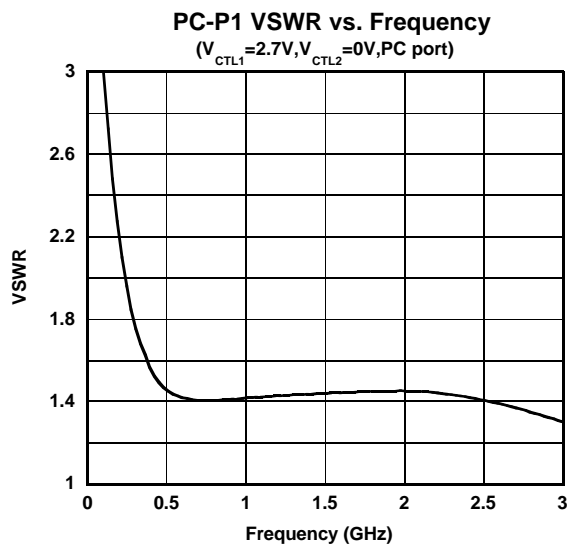
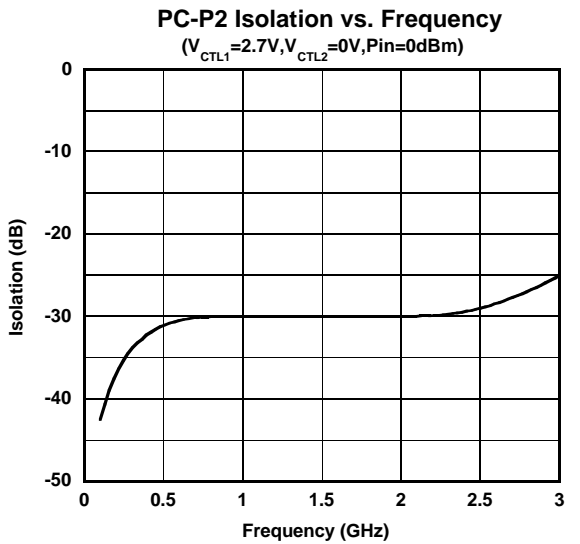
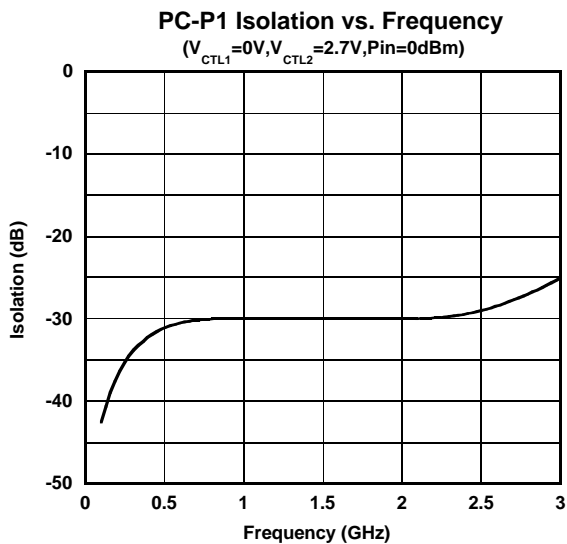
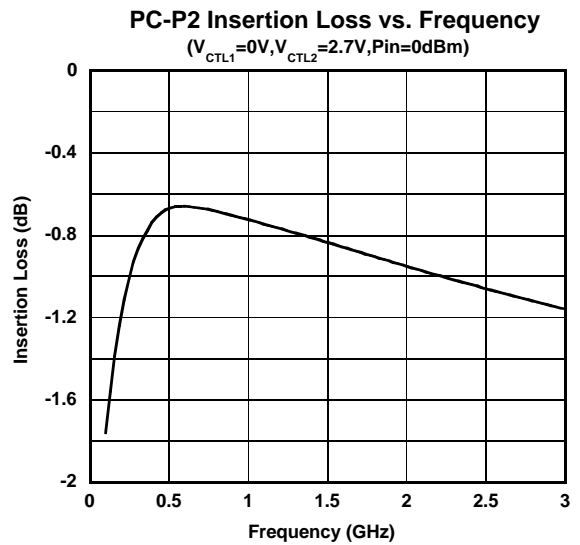
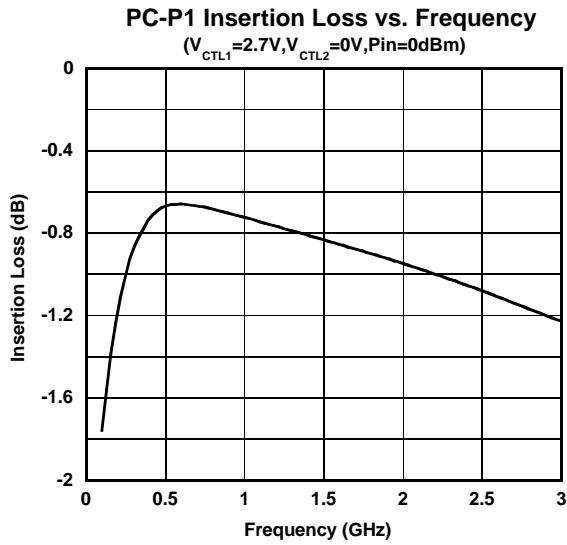

ELECTRICAL CHARACTERISTICS

(Losses of PCB, connector and DC blocking capacitor at each frequency.)

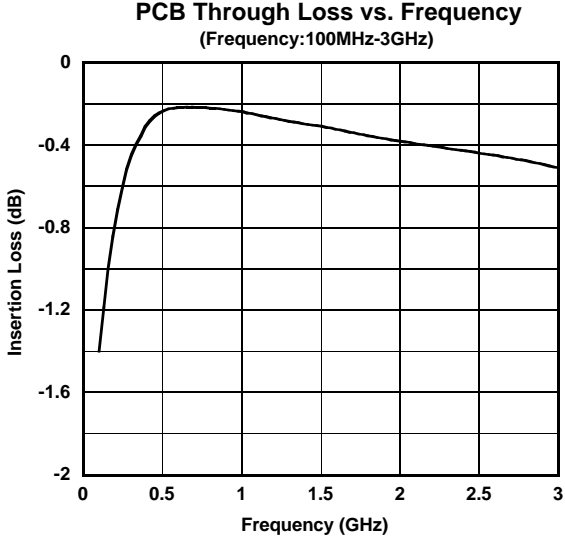
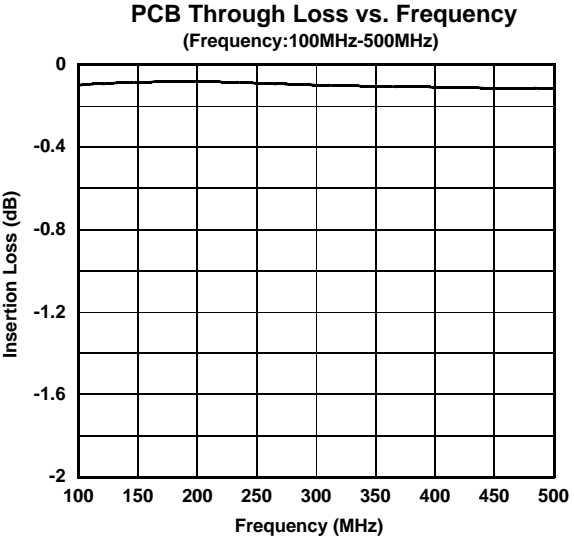
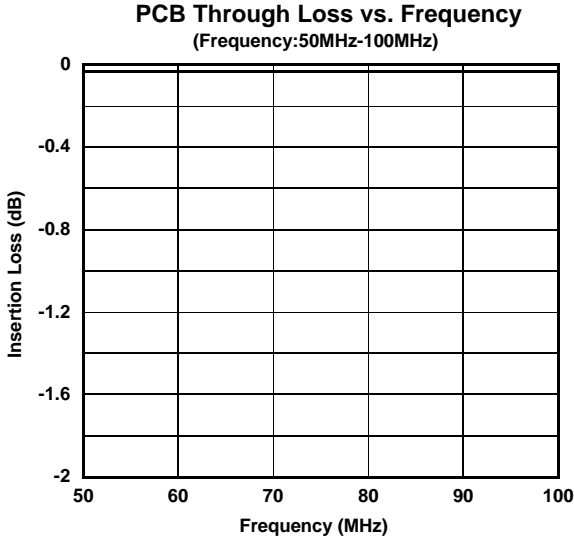

NJG1523KB2

APPLICATION CIRCUIT

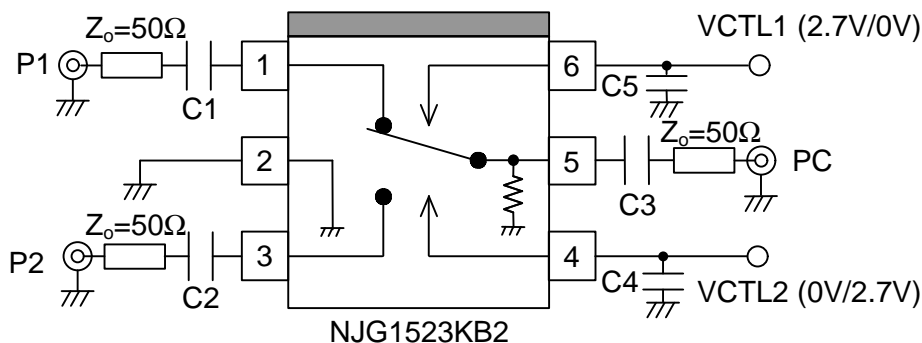

Parts List

Parts number	List 1	List 2	List 3	Notes
	50~100MHz	0.1~0.5GHz	0.5~2.5GHz	
C1~C3	0.01uF	1000pF	56pF	GRM36 MURATA
C4, C5	10pF	10pF	10pF	GRM36 MURATA

RECOMMENDED PCB DESIGN

(TOP VIEW)

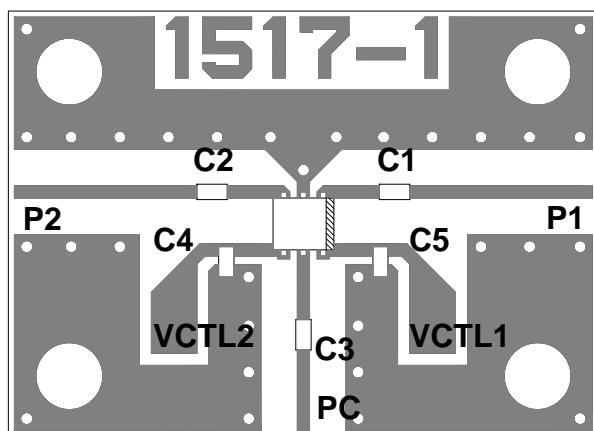

PCB SIZE=19.4x14.0mm
 PCB: FR-4, t=0.2mm
 CAPACITOR: size 1005
 STRIPLINE WIDTH=0.4mm

PRECAUTIONS

- [1] The DC blocking capacitors have to be placed at RF terminal of P1, P2 and PC. Please choose appropriate capacitance values to the application frequency.
- [2] To reduce stripline influence on RF characteristics, please locate bypass capacitors (C4, C5) close to each terminals.
- [3] For good isolation, the GND terminal (2nd pin) must be placed possibly close to ground plane of substrate, and through holes for GND should be placed near by the pin connection.

PACKAGE OUTLINE (FLP6-B2)

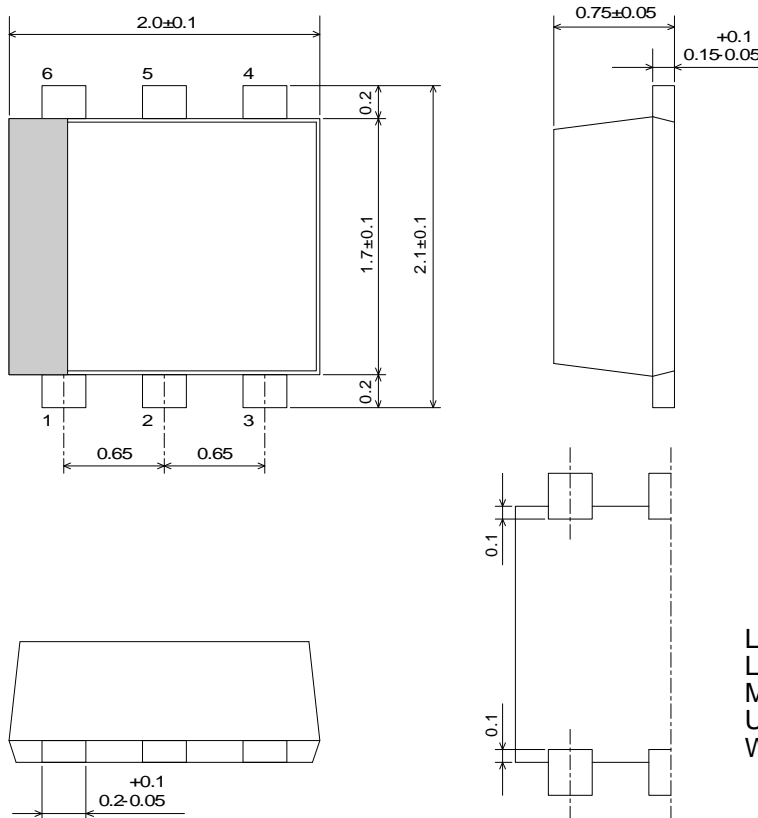

Lead material : Copper
 Lead surface finish : Solder plating
 Molding material : Epoxy resin
 UNIT : mm
 Weight : 6.5mg

Cautions on using this product

This product contains Gallium-Arsenide (GaAs) which is a harmful material.

- Do NOT eat or put into mouth.
- Do NOT dispose in fire or break up this product.
- Do NOT chemically make gas or powder with this product.
- To waste this product, please obey the relating law of your country.

[CAUTION]

The specifications on this databook are only given for information, without any guarantee as regards either mistakes or omissions. The application circuits in this databook are described only to show representative usages of the product and not intended for the guarantee or permission of any right including the industrial rights.

This product may be damaged with electric static discharge (ESD) or spike voltage. Please handle with care to avoid these damages.

Mouser Electronics

Authorized Distributor

Click to View Pricing, Inventory, Delivery & Lifecycle Information:

[NJR:](#)

[NJG1523KB2-TE2](#) [NJG1523KB2-TE1](#) [NJG#1523KB2-TE1](#)



Компания «ЭлектроПласт» предлагает заключение долгосрочных отношений при поставках импортных электронных компонентов на взаимовыгодных условиях!

Наши преимущества:

- Оперативные поставки широкого спектра электронных компонентов отечественного и импортного производства напрямую от производителей и с крупнейших мировых складов;
- Поставка более 17-ти миллионов наименований электронных компонентов;
- Поставка сложных, дефицитных, либо снятых с производства позиций;
- Оперативные сроки поставки под заказ (от 5 рабочих дней);
- Экспресс доставка в любую точку России;
- Техническая поддержка проекта, помощь в подборе аналогов, поставка прототипов;
- Система менеджмента качества сертифицирована по Международному стандарту ISO 9001;
- Лицензия ФСБ на осуществление работ с использованием сведений, составляющих государственную тайну;
- Поставка специализированных компонентов (Xilinx, Altera, Analog Devices, Intersil, Interpoint, Microsemi, Aeroflex, Peregrine, Syfer, Eurofarad, Texas Instrument, Miteq, Cobham, E2V, MA-COM, Hittite, Mini-Circuits, General Dynamics и др.);

Помимо этого, одним из направлений компании «ЭлектроПласт» является направление «Источники питания». Мы предлагаем Вам помощь Конструкторского отдела:

- Подбор оптимального решения, техническое обоснование при выборе компонента;
- Подбор аналогов;
- Консультации по применению компонента;
- Поставка образцов и прототипов;
- Техническая поддержка проекта;
- Защита от снятия компонента с производства.



Как с нами связаться

Телефон: 8 (812) 309 58 32 (многоканальный)

Факс: 8 (812) 320-02-42

Электронная почта: org@eplast1.ru

Адрес: 198099, г. Санкт-Петербург, ул. Калинина, дом 2, корпус 4, литера А.