

High Power Aluminum Nitride, Wraparound Surface Mount, Precision Thin Film Chip Resistor (up to 6 W)

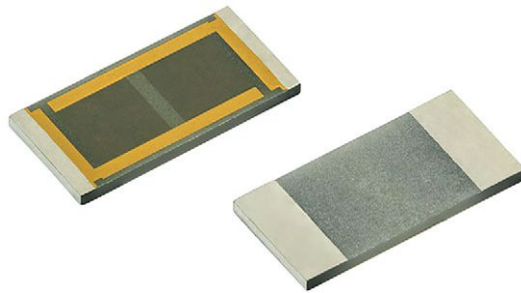

PCAN series chip resistors are designed on aluminum nitride ceramic substrates with enlarged backside terminations to reduce the thermal resistance between the topside resistor layer and the solder joint on the end users circuit assembly.

Actual power handling capability is limited by the end user mounting process. As with any high power chip resistor the ability to remove the heat is critical to the overall performance of the device.

FEATURES

- High thermal conductivity aluminum nitride substrate
- Power rating up to 6.0 W
- Resistance range 2 Ω to 30.1 k Ω
- Resistor tolerance to $\pm 0.1\%$
- TCR to ± 25 ppm/ $^{\circ}\text{C}$
- Flame resistant UL 94 V-0
- Material categorization: for definitions of compliance please see www.vishay.com/doc?99912



Available
RoHS*
 Available
HALOGEN FREE
GREEN
 (5-2008)
 Available

Note

* This datasheet provides information about parts that are RoHS-compliant and / or parts that are non-RoHS-compliant. For example, parts with lead (Pb) terminations are not RoHS-compliant. Please see the information / tables in this datasheet for details.

APPLICATIONS

- Power supplies
- Power switching
- Braking system

TYPICAL PERFORMANCE

	ABSOLUTE
TCR	25
TOL.	0.1

STANDARD ELECTRICAL SPECIFICATIONS		
TEST	SPECIFICATIONS	CONDITIONS
Material	Passivated nichrome	-
Resistance Range	2 Ω to 30.1 k Ω	-
TCR: Absolute	25 ppm/ $^{\circ}\text{C}$ (standard) and 100 ppm/ $^{\circ}\text{C}$	-
Tolerance: Absolute	0.1 %, 0.25 %, 0.5 %, 1.0 % and 5.0 %	-55 $^{\circ}\text{C}$ to +150 $^{\circ}\text{C}$
Power Rating: Resistor	0.5 W to 6.0 W ⁽¹⁾	Maximum at +70 $^{\circ}\text{C}$
Stability: Absolute	ΔR 1.0 %	1000 h at +70 $^{\circ}\text{C}$
Voltage Coefficient	< 0.1 ppm/V	-
Working Voltage	75 V to 200 V	-
Operating Temperature Range	-55 $^{\circ}\text{C}$ to +155 $^{\circ}\text{C}$	-
Storage Temperature Range	-55 $^{\circ}\text{C}$ to +155 $^{\circ}\text{C}$	-
Noise	< -30 dB	-
Shelf Life Stability: Absolute	$\pm 0.01\%$	1 year at +25 $^{\circ}\text{C}$

Note

⁽¹⁾ Dependant on component mounting by user.

COMPONENT RATINGS			
CASE SIZE	POWER RATING (mW)	WORKING VOLTAGE (V)	RESISTANCE RANGE (Ω)
0603	500 ⁽²⁾	75	2 to 30.1K
0805	1000 ⁽²⁾	100	2 to 30.1K
1206	2000 ⁽²⁾	200	2 to 30.1K
2512	6000 ⁽²⁾	200	2 to 30.1K

Note

⁽²⁾ Dependant on component mounting by user.

ENVIRONMENTAL TESTS		
ENVIRONMENTAL TEST	LIMITS MIL-PRF-55342 CHARACTERISTIC "H"	TYPICAL VISHAY PERFORMANCE
Resistance temperature characteristic	± 50 ppm/°C	± 25 ppm/°C
Maximum ambient temperature at rated wattage	+70 °C	+70 °C
Maximum ambient temperature at power derating	+150 °C	+150 °C
Thermal shock	± 0.25 %	± 0.10 %
Low temperature operation	± 0.25 %	± 0.10 %
Short time overload	± 0.1 %	± 0.10 %
High temperature exposure	± 0.2 %	± 0.10 %
Resistance to soldering heat	± 0.25 %	± 0.10 %
Moisture resistance	± 0.4 %	± 0.50 %
Life at +70 °C for 1000 h	± 0.5 %	± 1.00 %

DIMENSIONS in inches

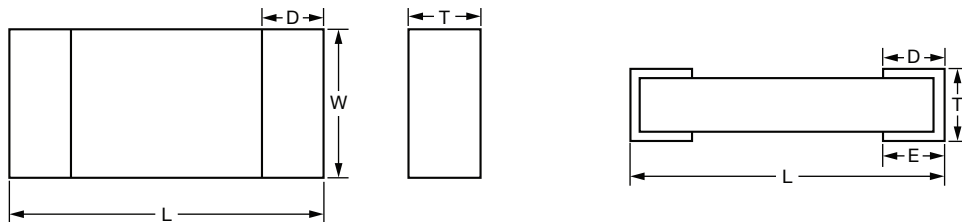

CASE SIZE	LENGTH L	WIDTH W	THICKNESS T MIN./MAX.	TOP PAD D	BOTTOM PAD E
0603	0.064 ± 0.006	0.032 ± 0.005	0.015 ± 0.003	0.012 ± 0.005	0.021 ± 0.005
0805	0.080 ± 0.006	0.050 ± 0.005	0.015 ± 0.003	0.016 ± 0.005	0.025 ± 0.005
1206	0.126 ± 0.008	0.063 ± 0.005	0.015 ± 0.003	0.020 + 0.005 / - 0.010	0.040 ± 0.005
2512	0.259 + 0.009 / - 0.015	0.124 ± 0.005	0.015 ± 0.003	0.020 ± 0.005	0.050 ± 0.005

LAND PATTERN DIMENSIONS in inches

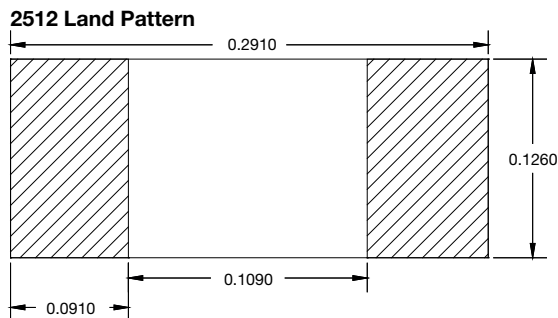
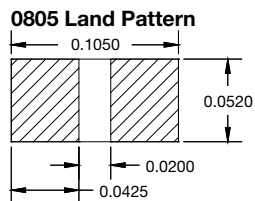
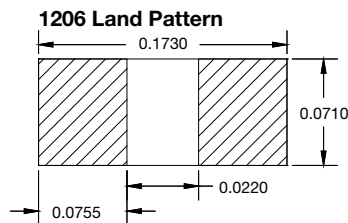
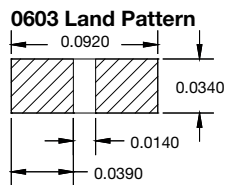



STANDARD MATERIAL SPECIFICATIONS	
Resistive element	Passivated nichrome
Substrate material	Aluminum nitride
Terminations (Tin/lead)	Tin/lead solder over nickel barrier
Terminations (Lead (Pb)-free)	Tin/silver/copper (Sn96.5/Ag3.0/Cu0.5) solder over nickel barrier

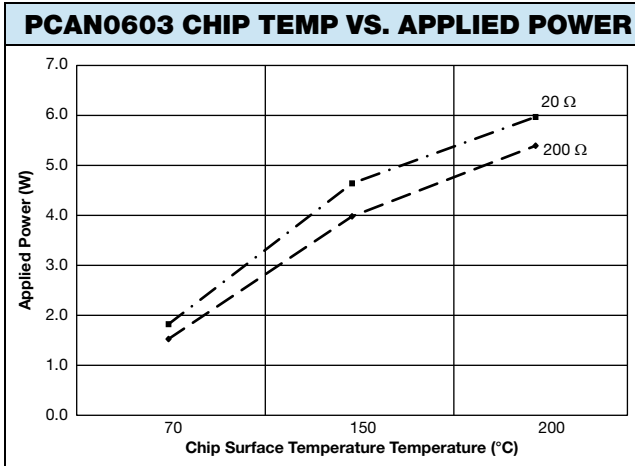

Note

- Chip surface temperature measured using FLIR SC645 thermal imaging system with an approximate testcard surface temperature of 75 °C.

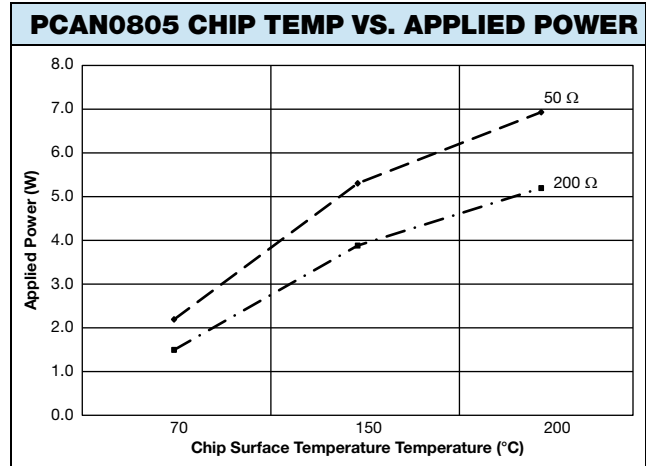

Note

- Chip surface temperature measured using FLIR SC645 thermal imaging system with an approximate testcard surface temperature of 75 °C.

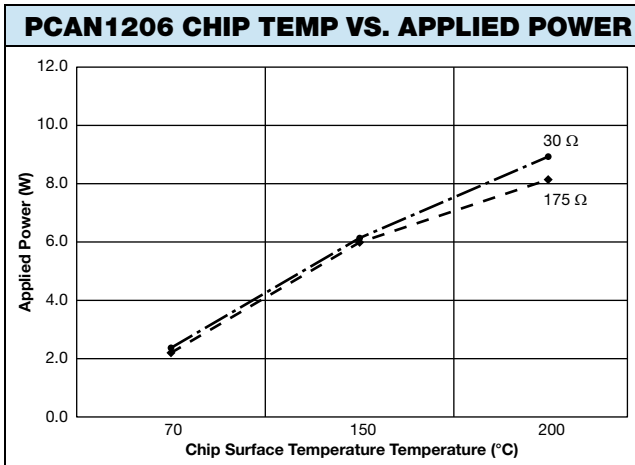

Note

- Chip surface temperature measured using FLIR SC645 thermal imaging system with an approximate test card surface temperature of 85 °C.
- Thermal imaging was conducted under ambient conditions resulting in a steady state test card surface temperature of 85 °C over the full range of power levels.
- Thermal imaging and load life testing was conducted mounting one device to a 1.6" x 3.7" test card with 3.5 mil copper plating on both surfaces. Thermal vias on 50 mil centers were utilized for heat transfer between surfaces of the test card.

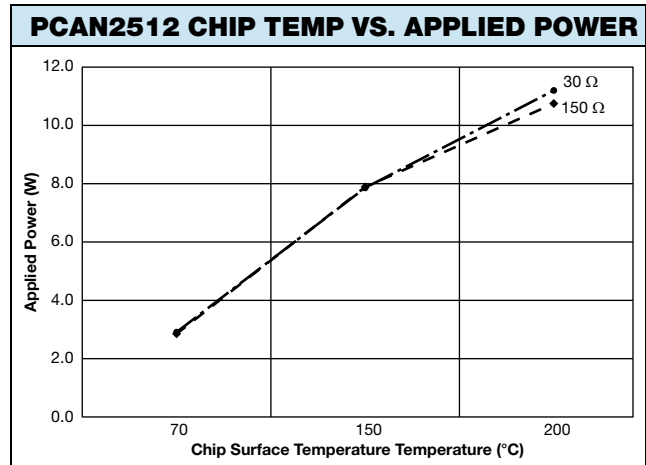

Note

- Chip surface temperature measured using FLIR SC645 thermal imaging system with an approximate test card surface temperature of 85 °C.

DERATING CURVE

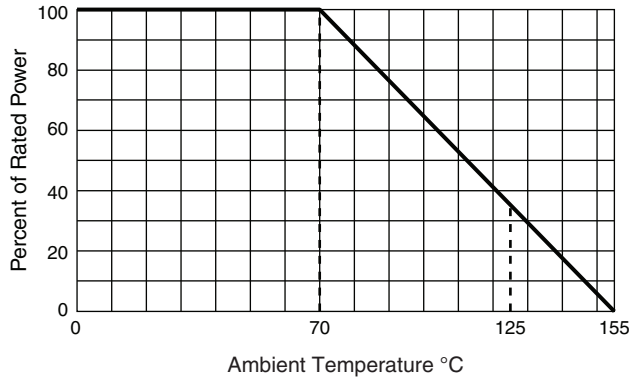

GLOBAL PART NUMBER INFORMATION

New Global Part Numbering: PCAN1206H1000BBT1

P **C** **A** **N** **1** **2** **0** **6** **H** **1** **0** **0** **0** **B** **B** **T** **1**

GLOBAL MODEL	CASE SIZE	TCR CHARACTERISTIC	RESISTANCE	TOLERANCE	TERMINATION	PACKAGING
PCAN	0603 0805 1206 2512	E = ± 25 ppm/°C H = ± 50 ppm/°C K = ± 100 ppm/°C ⁽¹⁾	The first 3 digits are significant figures and the last digit specifies the number of zeros to follow. "R" designates the decimal point. Example: 10R0 = 10 Ω 1000 = 100 Ω	B = ± 0.1 % ⁽²⁾ C = ± 0.25 % D = ± 0.5 % F = ± 1.0 % ⁽¹⁾ G = ± 2.0 %	B = Wraparound Sn/Pb solder w/ nickel barrier S = Wraparound lead (Pb)-free solder (e1) RoHS compliant G = Wraparound Au, over Ni (gold) termination epoxy bondable RoHS compliant (e4)	BS = BULK 100 min., 1 mult WS = WAFFLE 100 min., 1 mult W0 = 100 pc min. waffle, 1 mult W1 = 100 min., 1 mult (package unit single lot date code) TAPE AND REEL T0 = 100 min., 100 mult T1 = 1000 min., 1000 mult T3 = 300 min., 300 mult T5 = 500 min., 500 mult TF = Full reel TS = 100 min., 1 mult TI = 100 min., 1 mult (item single lot date code) TP = 100 min., 1 mult (package unit single lot date code)

Notes

- ⁽¹⁾ Less than 10 Ω. 100 ppm/°C and 1 % tolerance best.
- ⁽²⁾ Available on 10 Ω and higher.



Disclaimer

ALL PRODUCT, PRODUCT SPECIFICATIONS AND DATA ARE SUBJECT TO CHANGE WITHOUT NOTICE TO IMPROVE RELIABILITY, FUNCTION OR DESIGN OR OTHERWISE.

Vishay Intertechnology, Inc., its affiliates, agents, and employees, and all persons acting on its or their behalf (collectively, "Vishay"), disclaim any and all liability for any errors, inaccuracies or incompleteness contained in any datasheet or in any other disclosure relating to any product.

Vishay makes no warranty, representation or guarantee regarding the suitability of the products for any particular purpose or the continuing production of any product. To the maximum extent permitted by applicable law, Vishay disclaims (i) any and all liability arising out of the application or use of any product, (ii) any and all liability, including without limitation special, consequential or incidental damages, and (iii) any and all implied warranties, including warranties of fitness for particular purpose, non-infringement and merchantability.

Statements regarding the suitability of products for certain types of applications are based on Vishay's knowledge of typical requirements that are often placed on Vishay products in generic applications. Such statements are not binding statements about the suitability of products for a particular application. It is the customer's responsibility to validate that a particular product with the properties described in the product specification is suitable for use in a particular application. Parameters provided in datasheets and/or specifications may vary in different applications and performance may vary over time. All operating parameters, including typical parameters, must be validated for each customer application by the customer's technical experts. Product specifications do not expand or otherwise modify Vishay's terms and conditions of purchase, including but not limited to the warranty expressed therein.

Except as expressly indicated in writing, Vishay products are not designed for use in medical, life-saving, or life-sustaining applications or for any other application in which the failure of the Vishay product could result in personal injury or death. Customers using or selling Vishay products not expressly indicated for use in such applications do so at their own risk. Please contact authorized Vishay personnel to obtain written terms and conditions regarding products designed for such applications.

No license, express or implied, by estoppel or otherwise, to any intellectual property rights is granted by this document or by any conduct of Vishay. Product names and markings noted herein may be trademarks of their respective owners.

Material Category Policy

Vishay Intertechnology, Inc. hereby certifies that all its products that are identified as RoHS-Compliant fulfill the definitions and restrictions defined under Directive 2011/65/EU of The European Parliament and of the Council of June 8, 2011 on the restriction of the use of certain hazardous substances in electrical and electronic equipment (EEE) - recast, unless otherwise specified as non-compliant.

Please note that some Vishay documentation may still make reference to RoHS Directive 2002/95/EC. We confirm that all the products identified as being compliant to Directive 2002/95/EC conform to Directive 2011/65/EU.

Vishay Intertechnology, Inc. hereby certifies that all its products that are identified as Halogen-Free follow Halogen-Free requirements as per JEDEC JS709A standards. Please note that some Vishay documentation may still make reference to the IEC 61249-2-21 definition. We confirm that all the products identified as being compliant to IEC 61249-2-21 conform to JEDEC JS709A standards.



Компания «ЭлектроПласт» предлагает заключение долгосрочных отношений при поставках импортных электронных компонентов на взаимовыгодных условиях!

Наши преимущества:

- Оперативные поставки широкого спектра электронных компонентов отечественного и импортного производства напрямую от производителей и с крупнейших мировых складов;
- Поставка более 17-ти миллионов наименований электронных компонентов;
- Поставка сложных, дефицитных, либо снятых с производства позиций;
- Оперативные сроки поставки под заказ (от 5 рабочих дней);
- Экспресс доставка в любую точку России;
- Техническая поддержка проекта, помощь в подборе аналогов, поставка прототипов;
- Система менеджмента качества сертифицирована по Международному стандарту ISO 9001;
- Лицензия ФСБ на осуществление работ с использованием сведений, составляющих государственную тайну;
- Поставка специализированных компонентов (Xilinx, Altera, Analog Devices, Intersil, Interpoint, Microsemi, Aeroflex, Peregrine, Syfer, Eurofarad, Texas Instrument, Miteq, Cobham, E2V, MA-COM, Hittite, Mini-Circuits, General Dynamics и др.);

Помимо этого, одним из направлений компании «ЭлектроПласт» является направление «Источники питания». Мы предлагаем Вам помощь Конструкторского отдела:

- Подбор оптимального решения, техническое обоснование при выборе компонента;
- Подбор аналогов;
- Консультации по применению компонента;
- Поставка образцов и прототипов;
- Техническая поддержка проекта;
- Защита от снятия компонента с производства.



Как с нами связаться

Телефон: 8 (812) 309 58 32 (многоканальный)

Факс: 8 (812) 320-02-42

Электронная почта: org@eplast1.ru

Адрес: 198099, г. Санкт-Петербург, ул. Калинина, дом 2, корпус 4, литера А.