

TYPICAL SWITCH ORDERING EXAMPLE

**MB 2011 S B1 W 01 — D A**

**Poles & Circuits**

2011	SPDT	ON	(ON)
2065	SPDT	ON	ON
2061	DPDT	ON	(ON)
2085	DPDT	ON	ON
2181	4PDT	ON	(ON)
2185	4PDT	ON	ON

( ) = Momentary

**Plunger Type**

S	Plunger for Screw-on Caps
---	---------------------------

**Bushings**

B1	.472" (12.0mm) Threaded with Keyway
B3	.472" (12.0mm) Threaded w/Splashproof

**Contact Materials & Ratings**

W	Silver Rated 6A @ 125V AC & 3A @ 250V AC
G	Gold Rated 0.4VA max @ 28V AC/DC max

**Terminals**

01	Solder Lug*
02	Quick Connect
03	.250" (6.35mm) Straight PC
05	.425" (10.8mm) Wirewrap
06	.750" (19.05mm) Wirewrap
07	.964" (24.5mm) Wirewrap
08	1.062" (27.0mm) Wirewrap

**Caps**

B	.315" (8.0mm) Diameter
C	.394" (10.0mm) Diameter
D	.520" (13.2mm) Diameter
E	.748" (19.0mm) Diameter

**Cap Colors**

A	Black
B	White
C	Red
*D	Amber
*E	Yellow
F	Green
*G	Blue
*H	Gray

\* Not available with cap code E

**IMPORTANT:**



Switches are supplied without UL, cULus & CSA marking unless specified. **UL, cULus & CSA recognized only when ordered with marking on the switch.** Specific models, ratings, & ordering instructions are noted on General Specifications page.

\* Wire harness & cable assemblies offered only in Americas

DESCRIPTION FOR TYPICAL ORDERING EXAMPLE

**MB2011SB1W01-DA**

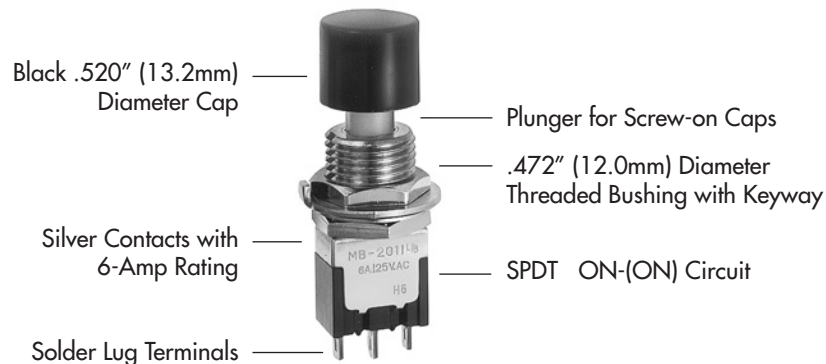

Toggles  
 Rockers  
**C** Pushbuttons  
 Illuminated PB  
 Programmable  
 Keylocks  
 Rotaries  
 Slides  
 Tactiles  
 Tilt  
 Touch  
 Indicators  
 Accessories  
 Supplement

Toggles

Rockers

Pushbuttons

Illuminated PB

Programmable

Keylocks

Rotaries

Slides

Tactiles

Tilt





Touch

Indicators

Accessories

Supplement

## POLES & CIRCUITS

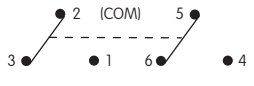
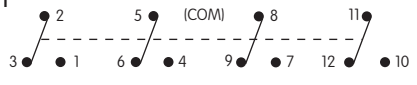
		Plunger Position ( ) = Momentary		Connected Terminals		Throw & Switch Schematics
Pole	Model	Normal 	Down 	Normal 	Down 	Note: Terminal numbers are not actually on the switch.
SP	MB2011 MB2065	ON	(ON)	2-3	2-1	SPDT 
DP	MB2061 MB2085	ON	(ON)	2-3 5-6	2-1 5-4	DPDT 
4P	MB2181 MB2185	ON	(ON)	2-3 5-6 8-9 11-12	2-1 5-4 8-7 11-10	4PDT 

## PLUNGER TYPE

**S**

**Plunger for Screw-on Caps**  
Plunger is plastic for B1 bushing.



Plunger is metal for B3 bushing.

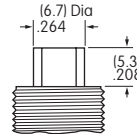

On alternate action models, after transferring circuit, the plunger returns to its original position, and does not latch down.

## BUSHINGS

**B1**

**.472" (12.0mm) Diameter Threaded with Keyway**

Maximum Panel Thickness with Standard Hardware: .217" (5.5mm)

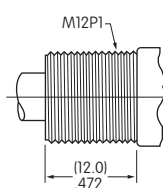
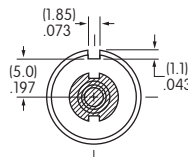

**B3**

**.472" (12.0mm) Diameter Threaded Splashproof**

Maximum Panel Thickness with Standard Hardware: .217" (5.5mm)

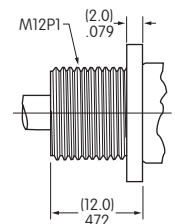
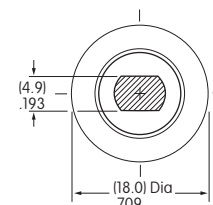

## Panel Cutouts

**For B1 Bushing with Keyway**

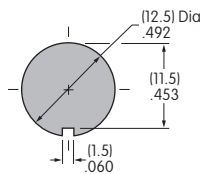

**For B1 Bushing with Locking Ring**

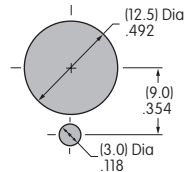

**For B3 Bushing without Keyway**

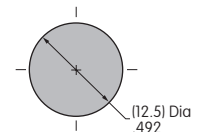

## CONTACT MATERIALS & RATINGS

**W**

Silver over Silver

Power Level

6A @ 125V AC & 3A @ 250V AC

**G**

Gold over Brass or Copper

Logic Level

0.4VA maximum @ 28V AC/DC maximum

Note: Complete explanation of operating range in Supplement section.

## TERMINALS

**01** Solder Lug

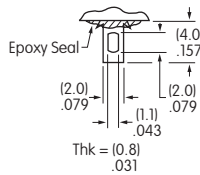

**02** .062" (1.57mm) Wide Quick Connect

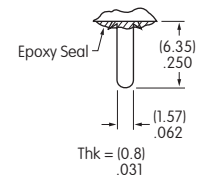

**03** .250" (6.35mm) Straight PC

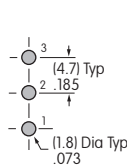
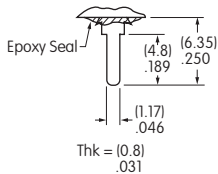

Single Pole

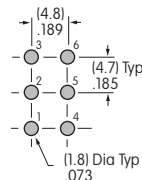

Double Pole

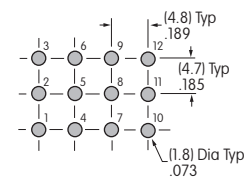

Four Pole

**05** .425" (10.8mm) Wirewrap or Extended PC

**06** .750" (19.05mm) Wirewrap or Extended PC

**07** .964" (24.5mm) Wirewrap or Extended PC

**08** 1.062" (27.0mm) Wirewrap or Extended PC

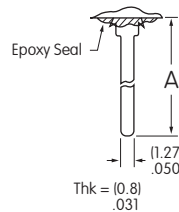

If using as extended PC terminal, refer to the above footprints.

Dimension A = terminal lengths as shown beside the terminal codes at the left.

## CAPS & CAP COLORS

**B** AT078  
.315" (8.0mm)  
Diameter Screw-on Cap

**C** AT079  
.394" (10.0mm)  
Diameter Screw-on Cap

**D** AT414  
.520" (13.2mm)  
Diameter Screw-on Cap

**E** AT412  
.748" (19.0mm)  
Diameter Screw-on Cap

Material:  
Polystyrene  
Finish:  
Glossy



Material:  
Polystyrene  
Finish:  
Glossy



Material:  
PBT  
Finish:  
Glossy



Material:  
Polystyrene  
Finish:  
Glossy



Colors Available:  
A B C E F G H

Colors Available:  
A B C E F G H

Colors Available:  
A B C D E F G H

Colors Available:  
A B C F

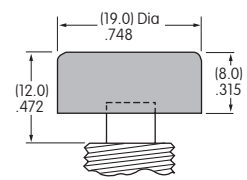
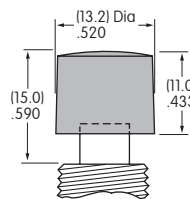
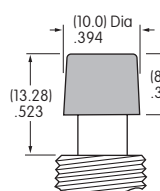
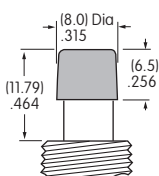

Cap Color  
Codes:

**A** Black **B** White **C** Red **D** Amber **E** Yellow **F** Green **G** Blue **H** Gray

## TYPICAL SWITCH DIMENSIONS

### Solder Lug

### Single Pole

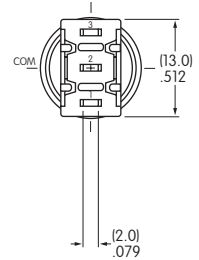
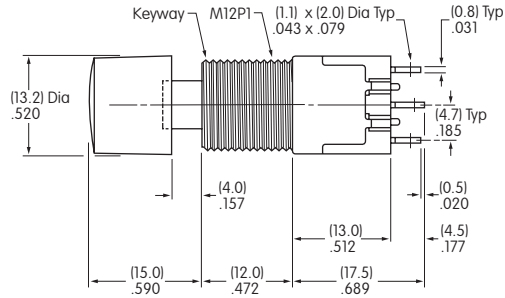
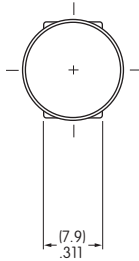

**MB2011SB1W01-DA**

### Solder Lug

### Double Pole

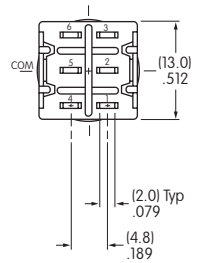
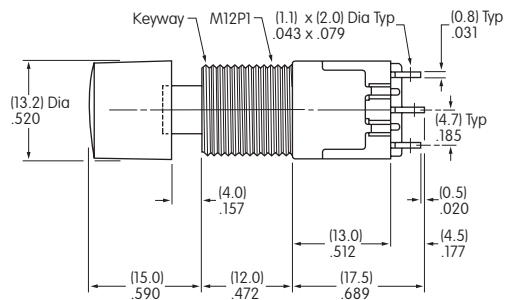
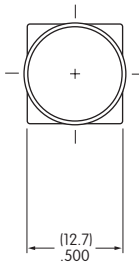

**MB2061SB1W01-DA**

### Solder Lug

### Four Pole

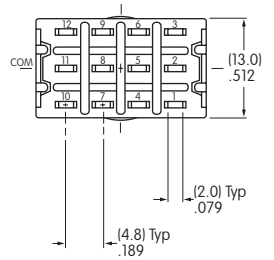
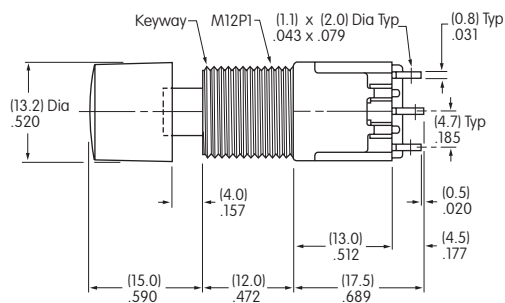
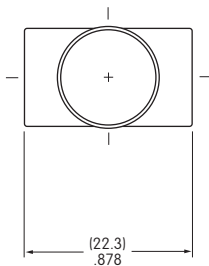

**MB2181SB1W01-DA**

## HARDWARE

### Standard Hardware for B1 Bushing

#### AT503M Hex Face Nut

Material:  
Brass with Chrome plating

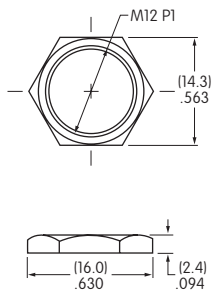

#### AT508 Lockwasher

Material:  
Steel with Zinc/Chromate

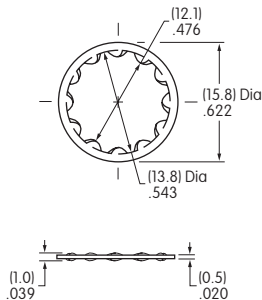

#### AT527M Hex Nut

Material:  
Steel with Nickel plating

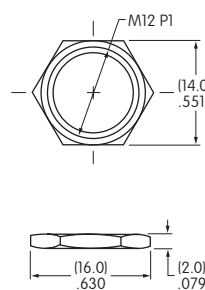

#### AT506M Locking Ring

Material:  
Steel with Zinc/Chromate

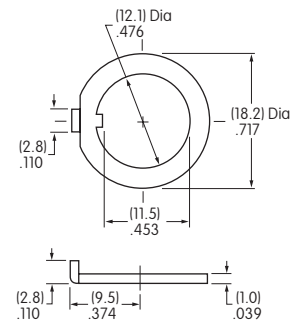

### Standard Hardware for B3 Bushing

#### AT503M Hex Face Nut

Material:  
Brass with Chrome plating

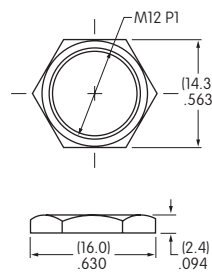

#### AT401P O-ring

Material:  
Nitrile butadiene rubber

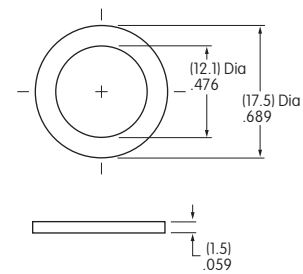

### Optional Splashproof Boot for B1 Bushing

#### AT4043 Splashproof Boot

Material: Silicone Rubber  
Operating Life: 10,000 for momentary  
30,000 for alternate action

When using a splashproof boot, no cap is required.

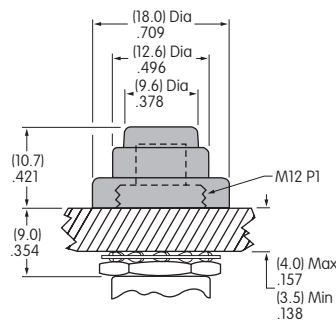

### CUSTOM ASSEMBLY ORDERING EXAMPLE

The MB2000 pushbutton series offers flexibility to accommodate a variety of applications. Using a basic large bushing model, different accessories can be assembled onto the switch to achieve the mounting variations shown on the following two pages.

- These switches have:
- 12mm diameter threaded bushing with keyway
  - Silver contacts
  - 6-Amp rating
  - Solder lug terminals

Other 12mm bushing options can be used; see details in preceding Large Bushing Ordering tables.

**MB2011**

**SB1W01**

**4**

**C**

**A**

Poles & Circuits			
<b>2011</b>	SPDT	ON	(ON)
<b>2065</b>	SPDT	ON	ON
<b>2061</b>	DPDT	ON	(ON)
<b>2085</b>	DPDT	ON	ON
4-pole available			
( ) = Momentary			

Mounter Shapes For Shroud	
<b>4</b>	Round
<b>5</b>	Rectangular

Cap Colors For Shroud	
<b>A</b>	Black
<b>B</b>	White
<b>C</b>	Red
<b>F</b>	Green
<b>G</b>	Blue
<b>H</b>	Gray

Mounter Colors For Shroud	
<b>A</b>	Black
<b>B</b>	White
<b>H</b>	Gray

Cap Colors For Snap-In	
<b>A</b>	Black
<b>B</b>	White
<b>C</b>	Red
<b>F</b>	Green



**Round Shroud**  
**MB2011SB1W01-4C-A**



**Rectangular Shroud**  
**MB2011SB1W01-5C-A**

See custom assemblies on following pages.

Toggles  
 Rockers  
 Pushbuttons  
 Illuminated PB  
 Programmable  
 Keylocks  
 Rotaries  
 Slides  
 Tactiles  
 Tilt  
 Touch  
 Indicators  
 Accessories  
 Supplement

MOUNTER SHAPES FOR SHROUDS

**4** AT455 Round

Material: Polycarbonate  
Colors: A B H



**5** AT453 Rectangular

Material: Polycarbonate  
Colors: A B H



CAPS & CAP COLORS FOR SHROUDS

AT454 Round  
Insert Cap

Material: Polycarbonate  
Colors: A B C F G H



AT452 Rectangular  
Insert Cap

Material: Polycarbonate  
Colors: A B C F G H



AT080 Screw Adaptor for Insert Caps

Material: Brass



Color Codes:

- A** Black
- B** White
- C** Red
- F** Green
- G** Blue
- H** Gray

Toggle

Rockers

**C** Pushbuttons

Illuminated PB

Programmable

Keylocks

Rotaries

Slides

Tactiles

Tilt

Touch

Indicators

Accessories

Supplement

## CUSTOM ASSEMBLY WITH ROUND SHROUD



**MB2011SB1W01-4C-A**

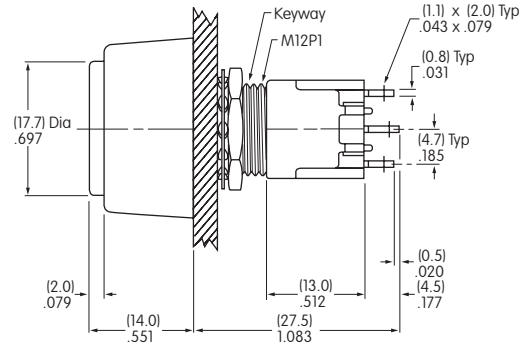
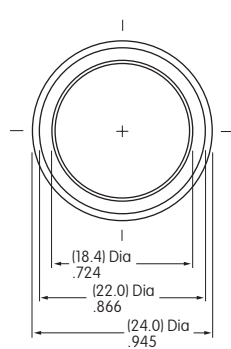

### Single Pole

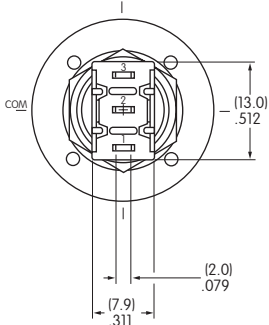

### Double Pole

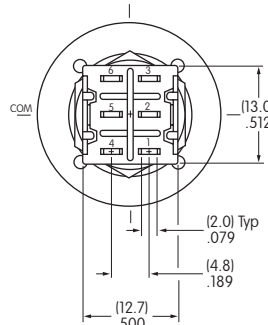

Effective Panel Thickness:  
.217" (5.5mm) maximum

## CUSTOM ASSEMBLY WITH RECTANGULAR SHROUD



**MB2011SB1W01-5C-A**

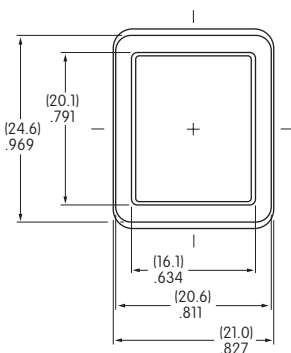

### Single Pole

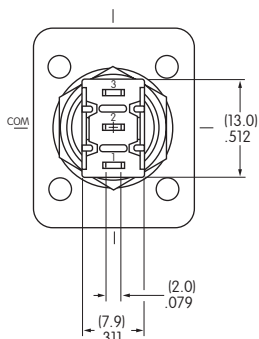

### Double Pole

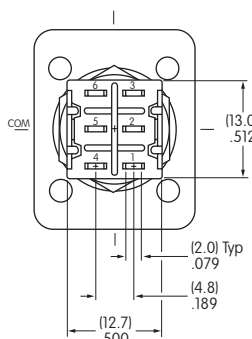

Effective Panel Thickness:  
.217" (5.5mm) maximum







Компания «ЭлектроПласт» предлагает заключение долгосрочных отношений при поставках импортных электронных компонентов на взаимовыгодных условиях!

Наши преимущества:

- Оперативные поставки широкого спектра электронных компонентов отечественного и импортного производства напрямую от производителей и с крупнейших мировых складов;
- Поставка более 17-ти миллионов наименований электронных компонентов;
- Поставка сложных, дефицитных, либо снятых с производства позиций;
- Оперативные сроки поставки под заказ (от 5 рабочих дней);
- Экспресс доставка в любую точку России;
- Техническая поддержка проекта, помощь в подборе аналогов, поставка прототипов;
- Система менеджмента качества сертифицирована по Международному стандарту ISO 9001;
- Лицензия ФСБ на осуществление работ с использованием сведений, составляющих государственную тайну;
- Поставка специализированных компонентов (Xilinx, Altera, Analog Devices, Intersil, Interpoint, Microsemi, Aeroflex, Peregrine, Syfer, Eurofarad, Texas Instrument, Miteq, Cobham, E2V, MA-COM, Hittite, Mini-Circuits, General Dynamics и др.);

Помимо этого, одним из направлений компании «ЭлектроПласт» является направление «Источники питания». Мы предлагаем Вам помощь Конструкторского отдела:

- Подбор оптимального решения, техническое обоснование при выборе компонента;
- Подбор аналогов;
- Консультации по применению компонента;
- Поставка образцов и прототипов;
- Техническая поддержка проекта;
- Защита от снятия компонента с производства.



#### Как с нами связаться

**Телефон:** 8 (812) 309 58 32 (многоканальный)

**Факс:** 8 (812) 320-02-42

**Электронная почта:** [org@eplast1.ru](mailto:org@eplast1.ru)

**Адрес:** 198099, г. Санкт-Петербург, ул. Калинина, дом 2, корпус 4, литера А.