



Product Description

GRF3044 is a broadband low noise gain block designed for applications up to 11.0 GHz, exhibiting a typical low noise figure (NF) of 1.8 dB along with high gain.

This resistively biased device employs an external resistor in series with V_{DD} to set a nominal I_{DDQ} of 100 mA. GRF3044 is internally matched to 50Ω at the input and output ports.

The device can be operated down to low frequency via the selection of suitably large input/output caps and bias inductor.

Consult with the GRF applications engineering team for custom tuning/evaluation board data and device s-parameters.

Features

- Reference: 4.0 GHz; I_{DDQ} : 100 mA
- Gain: 16.6 dB
- OP1dB: 19.8 dBm
- OIP3: 31.5 dBm
- NF: 1.8 dB

- Internally Matched to 50Ω
- Process: GaAs pHEMT

Applications

- Microwave Backhaul
- C and X-Band Amplifiers
- General Purpose Amplifiers
- Instrumentation

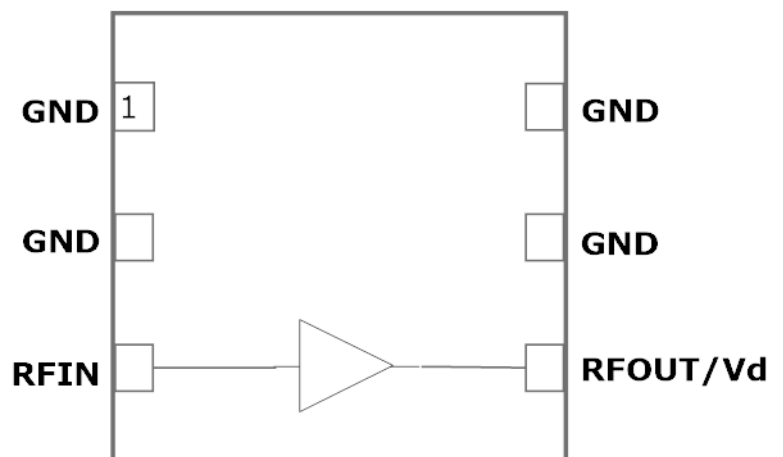

1.5 x 1.5 mm DFN-6

Absolute Ratings:

Parameter	Symbol	Min.	Max.	Unit
Drain Voltage	V _D	0	6.0	V
RF Input Power: (Load VSWR < 2:1; V _D : 5.0 volts)	P _{IN MAX}		17	dBm
Operating Temperature (Package Heat Sink)	T _{AMB}	-40	105	°C
Maximum Channel Temperature (MTTF > 10 ⁶ Hours)	T _{MAX}		170	°C
Maximum Dissipated Power	P _{DISS MAX}		700	mW
Electrostatic Discharge:				
Charged Device Model:	CDM	1500		V
Human Body Model:	HBM	250		V
Storage:				
Storage Temperature	T _{STG}	-65	150	°C
Moisture Sensitivity Level	MSL		1	--



Caution! ESD Sensitive Device



Exceeding Absolute Maximum Rating conditions may cause permanent damage to the device.

Note: For package dimensions and manufacturing information, see the Guerrilla-RF.com website for the following document located on the GRF3044 landing page: **Manufacturing Note—MN-001 Product Tape and Reel, Solderability and Package Outline Specification.**

[Link to manufacturing note](#)

Pin Out (Top View)

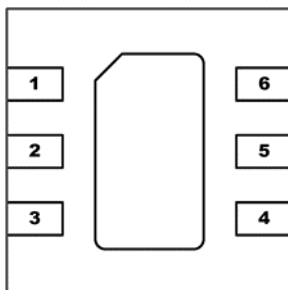

Pin Assignments:

Pin	Name	Description	Note
1	NC	No Connect or Ground	No internal connection to die
2	NC	No Connect or Ground	No internal connection to die
3	RF_In	LNA RF input	Internally matched 50Ω. An external DC blocking cap must be used.
4	RF_Out/V _{DD}	LNA RF output	Internally matched 50Ω. V _{DD} must be applied through a choke to this pin
5	NC	No Connect or Ground	No internal connection to die
6	NC	No Connect or Ground	No internal connection to die
PKG BASE	GND	Ground	Provides DC and RF ground for LNA, as well as thermal heat sink. Recommend multiple 8 mil vias beneath the package for optimal RF and thermal performance. Refer to evaluation board top layer graphic on schematic page.



Preliminary

GRF3044

Broadband Gain Block
100 MHz to 12.0 GHz

Nominal Operating Parameters:

Parameter	Symbol	Specification			Unit	Condition
		Min.	Typ.	Max.		
Gain Mode (Venable high)						I _{DDQ} = 100 mA, T _A = 25 °C
Test Frequency	F _{TEST}		4.0		GHz	
Gain	S ₂₁	15.6	16.6		dB	
Noise Figure	NF		1.8		dB	Input trace losses de-embedded
Output 3rd Order Intercept	OIP ₃		31.5		dBm	+2 dBm P _{OUT} per tone at 2 MHz Spacing (3999 and 4001 MHz)
Output 1dB Compression Power	OP _{1dB}	18.8	19.8		dBm	
Switching Rise Time	T _{RISE}		500		ns	
Switching Fall Time	T _{FALL}		500		ns	
Supply Current	I _{DDQ}	90	100	110	mA	Ref: V _{DD} : 7.0 V; R _{BIAS} : 13 Ohm
Thermal Data						
Thermal Resistance (measured via IR scan)	Θ _{JC}		102		°C/W	On standard evaluation board
Channel Temperature @ +85 C Reference (Package Heat Sink)	T _{CHANNEL}		148		°C	V _D : 5.6 V; I _{DDQ} : 110 mA; No RF; P _{BISS} : 616 mW

GRF3044 Evaluation Board Measured Data; (5-Volt Schematic)

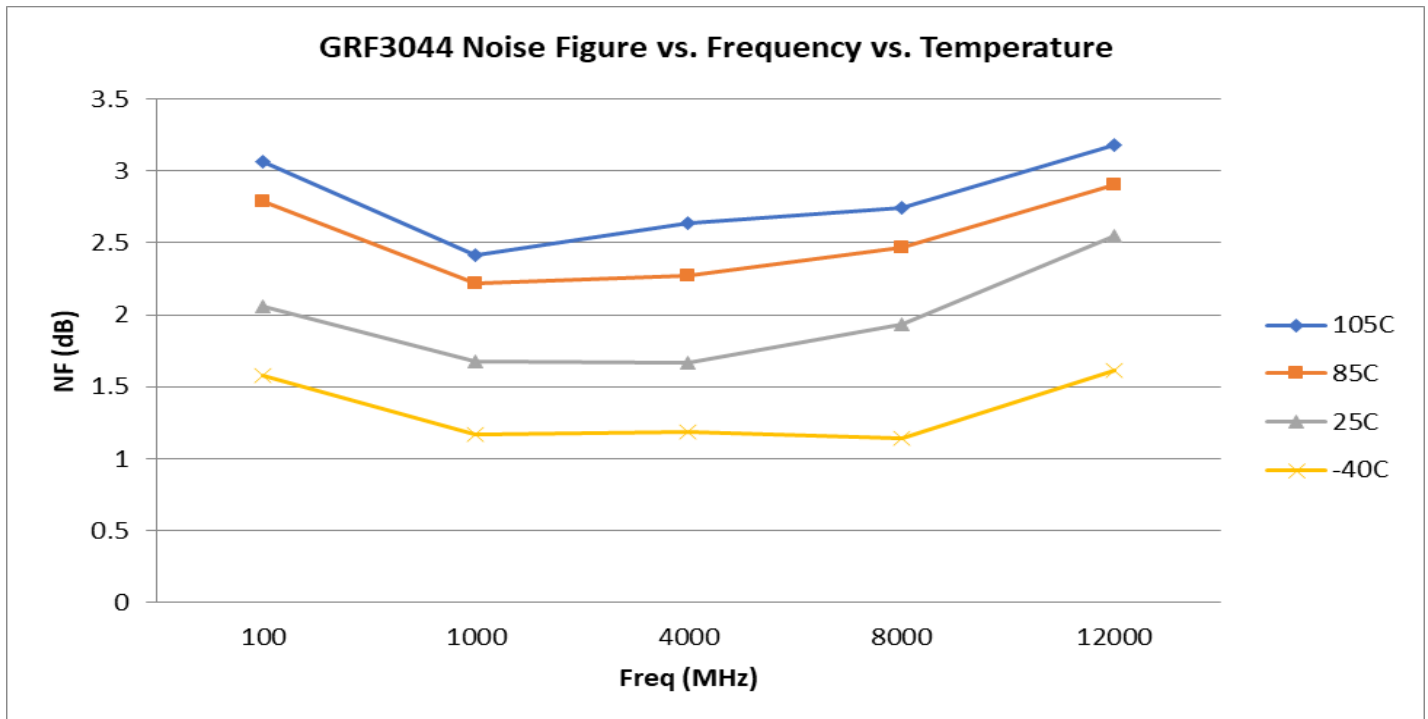
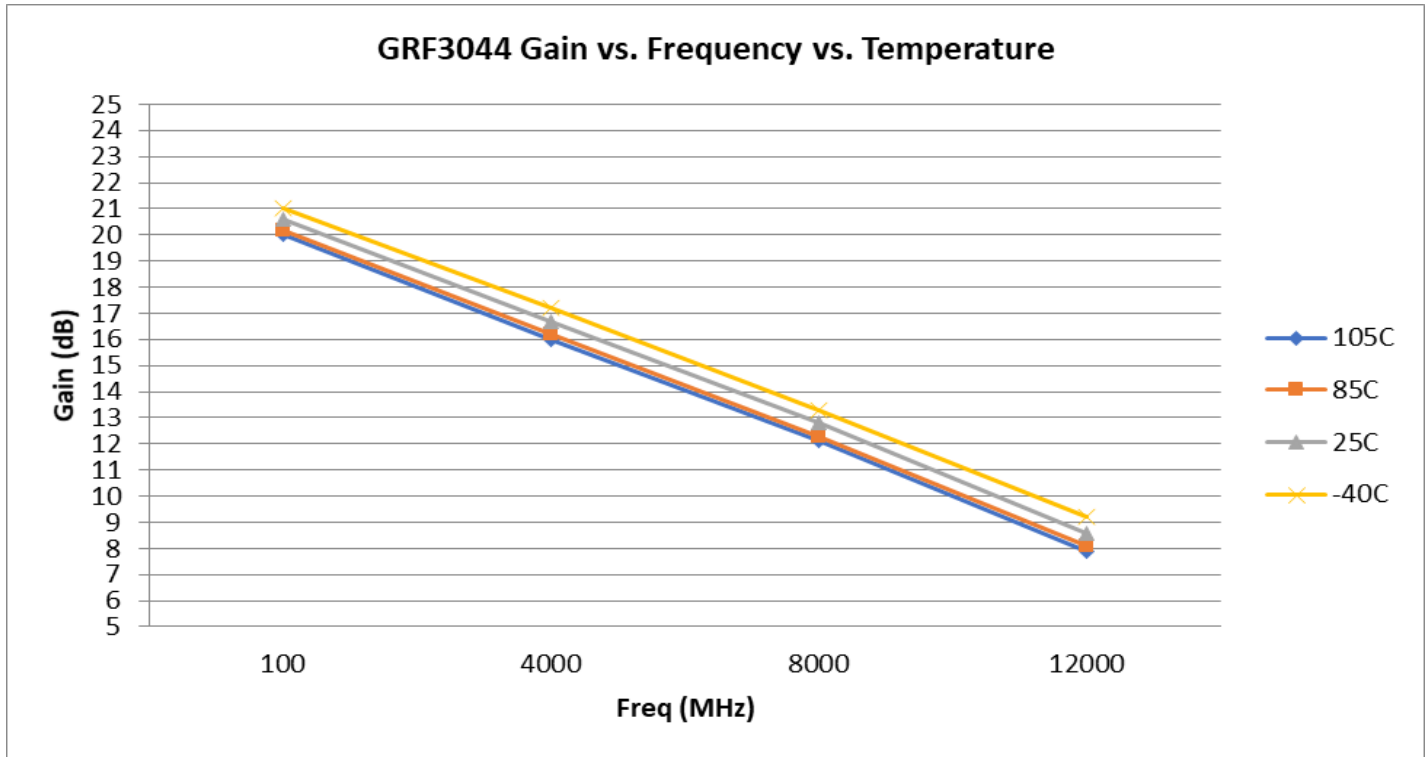



Preliminary

GRF3044

Broadband Gain Block
100 MHz to 12.0 GHz

GRF3044 Evaluation Board Measured Data; (5-Volt Schematic)

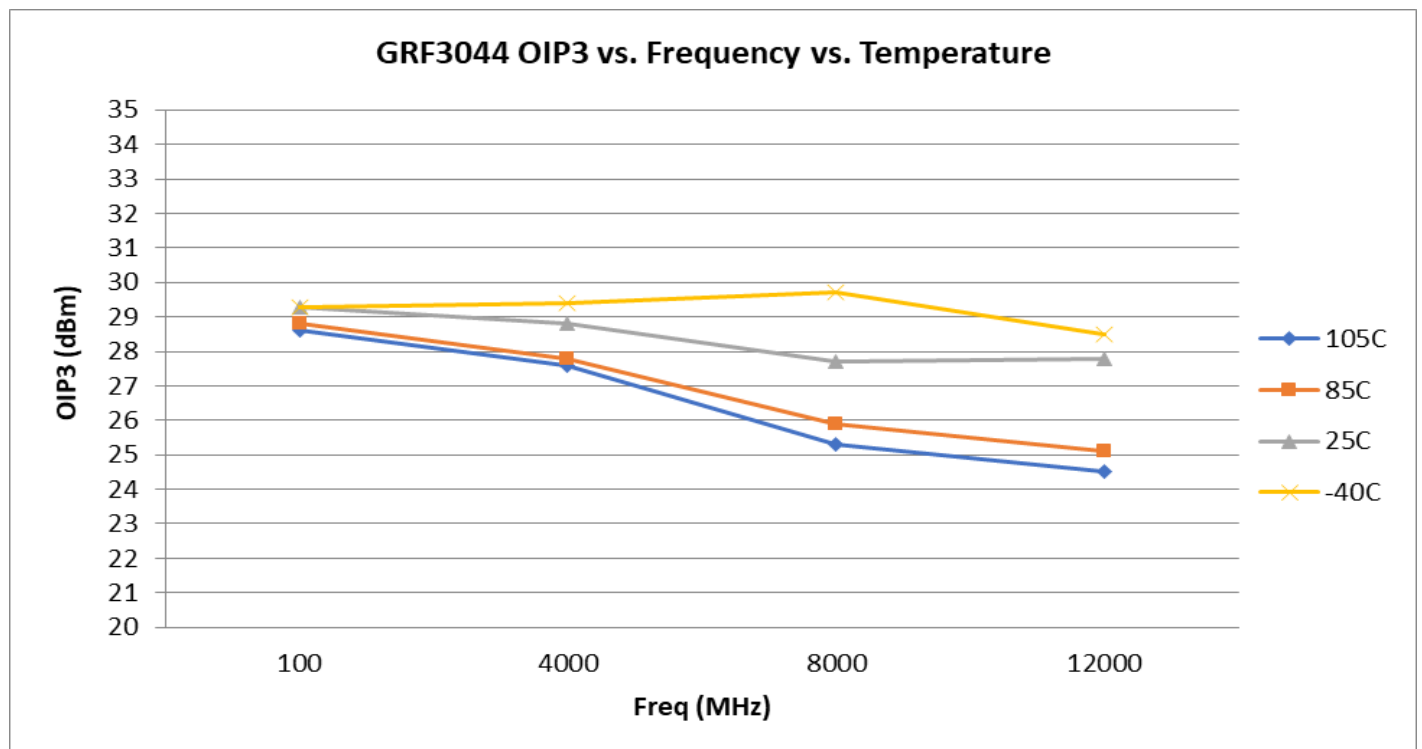
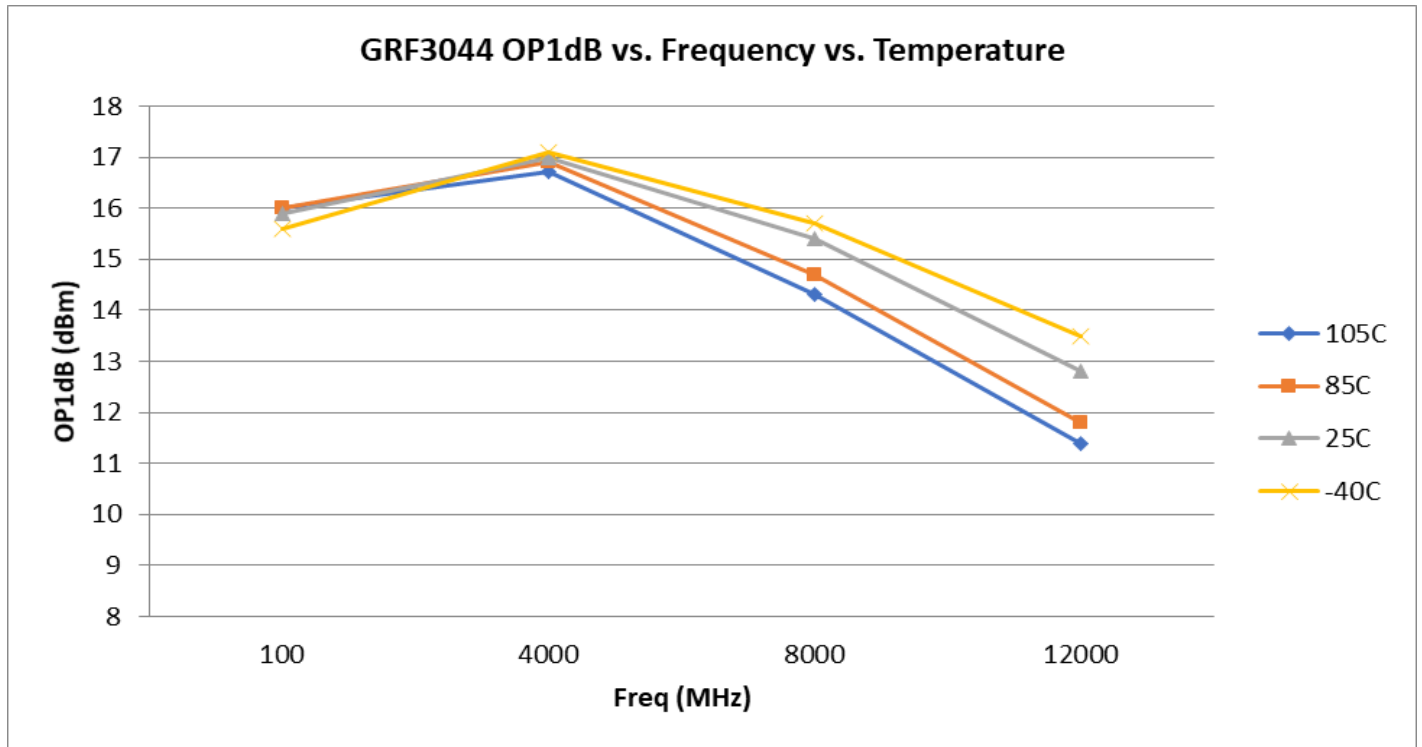

GRF3044 Evaluation Board S-Pars and Stability Mu Factor:

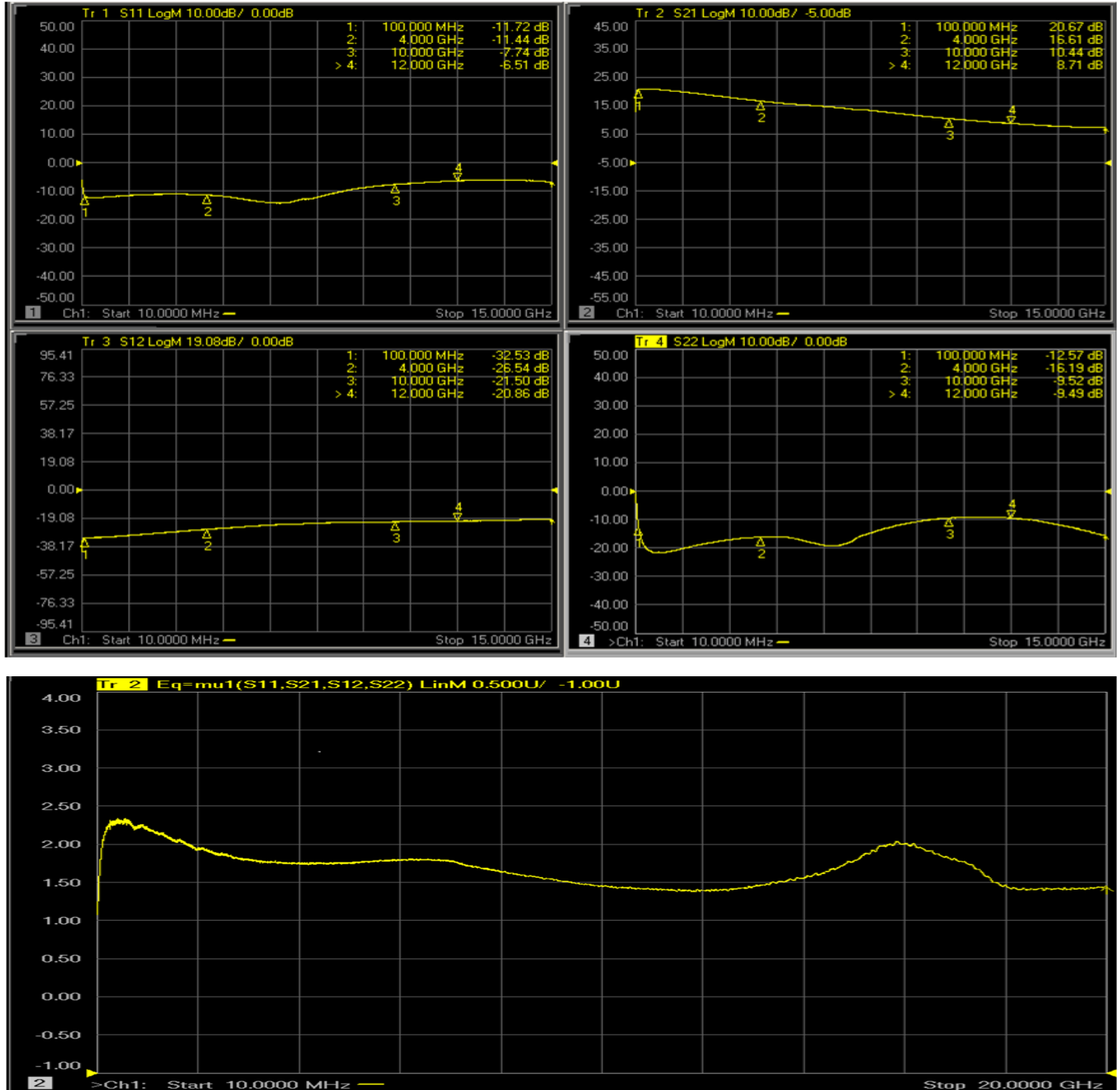

Note: Mu factor ≥ 1.0 implies unconditional stability.

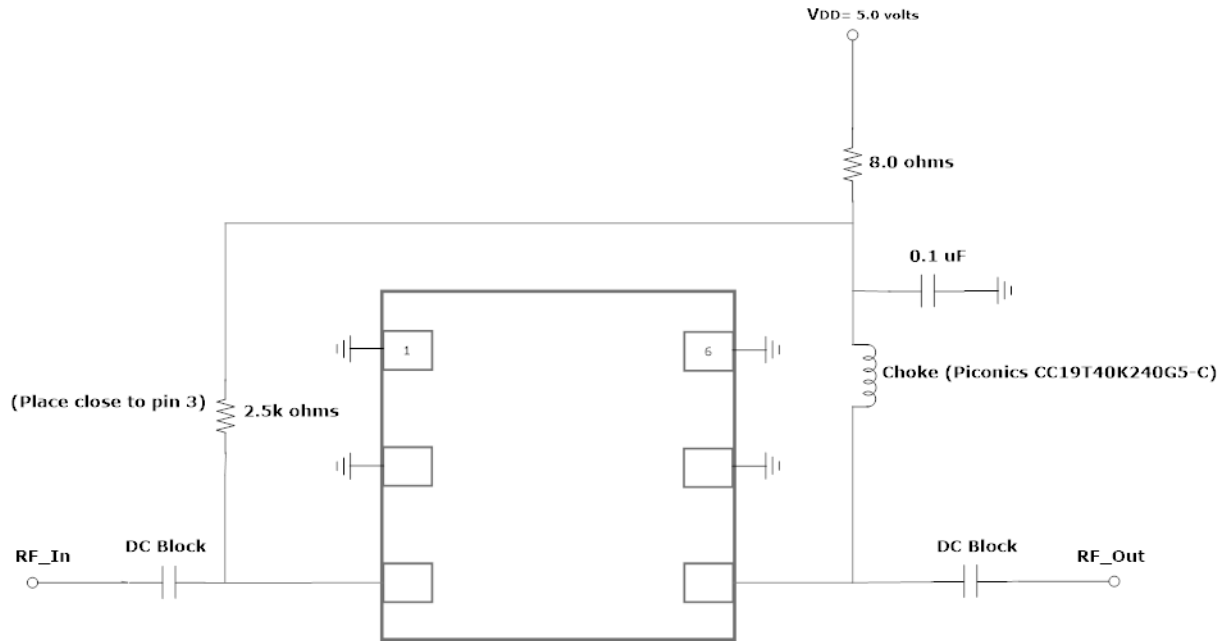

GRF3044 Standard 5-Volt Application Schematic



Preliminary

GRF3044

**Broadband Gain Block
100 MHz to 12.0 GHz**

GRF3044 Theory of Operation:

5-Volt Operation: The device can be operated with Vdd as low as 5 volts and the required 5-Volt application schematic is shown immediately below the standard schematic. Note that the device linearity will be degraded somewhat due to the voltage drop across the series bias R.

BOM: DC blocking caps must be used on both RF_In and RF_Out. These caps also need to be essentially an RF short over the band of interest. The bias inductor should be an RF choke over the target frequency range. For general purpose, extreme broadband performance, a large value conical inductor such as the Piconics: 220 nH (CC19T40K240G5-C) makes a good choice.



Preliminary

GRF3044

**Broadband Gain Block
100 MHz to 12.0 GHz**

Data Sheet Release Status:	Notes
Advance	S-parameter and NF data based on EM simulations for the fully packaged device using foundry supplied transistor s-parameters. Linearity estimates based on device size, bias condition and experience with related devices.
Preliminary	All data based on evaluation board measurements in the Guerrilla RF Applications Lab.
Released	All data based on device qualification data. Typically, this data is nearly identical to the data found in the preliminary version. Max and min values for key RF parameters are included.

Information in this datasheet is specific to the Guerrilla RF, Inc. ("Guerrilla RF") product identified.

This datasheet, including the information contained in it, is provided by Guerrilla RF as a service to its customers and may be used for informational purposes only by the customer. Guerrilla RF assumes no responsibility for errors or omissions on this datasheet or the information contained herein. Information provided is believed to be accurate and reliable, however, no responsibility is assumed by Guerrilla RF for its use, nor for any infringement of patents, or other rights of third parties, resulting from its use. Guerrilla RF assumes no liability for any datasheet, datasheet information, materials, products, product information, or other information provided hereunder, including the sale, distribution, reproduction or use of Guerrilla RF products, information or materials.

No license, whether express, implied, by estoppel, by implication or otherwise is granted by this datasheet for any intellectual property of Guerrilla RF, or any third party, including without limitation, patents, patent rights, copyrights, trademarks and trade secrets. All rights are reserved by Guerrilla RF.

All information herein, products, product information, datasheets, and datasheet information are subject to change and availability without notice. Guerrilla RF reserves the right to change component circuitry, recommended application circuitry and specifications at any time without prior notice. Guerrilla RF may further change its datasheet, product information, documentation, products, services, specifications or product descriptions at any time, without notice. Guerrilla RF makes no commitment to update any materials or information and shall have no responsibility whatsoever for conflicts, incompatibilities, or other difficulties arising from any future changes.

GUERRILLA RF INFORMATION, PRODUCTS, PRODUCT INFORMATION, DATASHEETS AND DATASHEET INFORMATION ARE PROVIDED "AS IS" AND WITHOUT WARRANTY OF ANY KIND, WHETHER EXPRESS, IMPLIED, STATUTORY, OR OTHERWISE, INCLUDING FITNESS FOR A PARTICULAR PURPOSE OR USE, MERCHANTABILITY, PERFORMANCE, QUALITY OR NON-INFRINGEMENT OF ANY INTELLECTUAL PROPERTY RIGHT; ALL SUCH WARRANTIES ARE HEREBY EXPRESSLY DISCLAIMED. GUERRILLA RF DOES NOT WARRANT THE ACCURACY OR COMPLETENESS OF THE INFORMATION, TEXT, GRAPHICS OR OTHER ITEMS CONTAINED WITHIN THESE MATERIALS. GUERRILLA RF SHALL NOT BE LIABLE FOR ANY DAMAGES, INCLUDING BUT NOT LIMITED TO ANY SPECIAL, INDIRECT, INCIDENTAL, STATUTORY, OR CONSEQUENTIAL DAMAGES, INCLUDING WITHOUT LIMITATION, LOST REVENUES OR LOST PROFITS THAT MAY RESULT FROM THE USE OF THE MATERIALS OR INFORMATION, WHETHER OR NOT THE RECIPIENT OF MATERIALS HAS BEEN ADVISED OF THE POSSIBILITY OF SUCH DAMAGE.

Customers are solely responsible for their use of Guerrilla RF products in the Customer's products and applications or in ways which deviate from Guerrilla RF's published specifications, either intentionally or as a result of design defects, errors, or operation of products outside of published parameters or design specifications. Customers should include design and operating safeguards to minimize these and other risks. Guerrilla RF assumes no liability or responsibility for applications assistance, customer product design, or damage to any equipment resulting from the use of Guerrilla RF products outside of stated published specifications or parameters.



Компания «ЭлектроПласт» предлагает заключение долгосрочных отношений при поставках импортных электронных компонентов на взаимовыгодных условиях!

Наши преимущества:

- Оперативные поставки широкого спектра электронных компонентов отечественного и импортного производства напрямую от производителей и с крупнейших мировых складов;
- Поставка более 17-ти миллионов наименований электронных компонентов;
- Поставка сложных, дефицитных, либо снятых с производства позиций;
- Оперативные сроки поставки под заказ (от 5 рабочих дней);
- Экспресс доставка в любую точку России;
- Техническая поддержка проекта, помощь в подборе аналогов, поставка прототипов;
- Система менеджмента качества сертифицирована по Международному стандарту ISO 9001;
- Лицензия ФСБ на осуществление работ с использованием сведений, составляющих государственную тайну;
- Поставка специализированных компонентов (Xilinx, Altera, Analog Devices, Intersil, Interpoint, Microsemi, Aeroflex, Peregrine, Syfer, Eurofarad, Texas Instrument, Miteq, Cobham, E2V, MA-COM, Hittite, Mini-Circuits, General Dynamics и др.);

Помимо этого, одним из направлений компании «ЭлектроПласт» является направление «Источники питания». Мы предлагаем Вам помощь Конструкторского отдела:

- Подбор оптимального решения, техническое обоснование при выборе компонента;
- Подбор аналогов;
- Консультации по применению компонента;
- Поставка образцов и прототипов;
- Техническая поддержка проекта;
- Защита от снятия компонента с производства.



Как с нами связаться

Телефон: 8 (812) 309 58 32 (многоканальный)

Факс: 8 (812) 320-02-42

Электронная почта: org@eplast1.ru

Адрес: 198099, г. Санкт-Петербург, ул. Калинина, дом 2, корпус 4, литера А.