

# Thin-Film Directional Couplers



## CP0805 SMD Type

### GENERAL DESCRIPTION ITF (Integrated Thin-Film) TECHNOLOGY

The ITF SMD Coupler is based on thin-film multilayer technology. The technology provides a miniature part with excellent high frequency performance and rugged construction for reliable automatic assembly.

The ITF Coupler is offered in a variety of frequency bands compatible with various types of high frequency wireless systems.

### FEATURES

- Small Size: 0805
- Frequency Range: 800MHz - 3GHz
- Characteristic Impedance: 50Ω
- Operating / Storage Temp.: -40°C to +85°C
- Power Rating: 3W Continuous
- Low Profile
- Rugged Construction
- Taped and Reeled

### APPLICATIONS

- Mobile Communications
- Satellite TV Receivers
- GPS
- Vehicle Location Systems
- Wireless LAN's

### DIMENSIONS: (Top View)

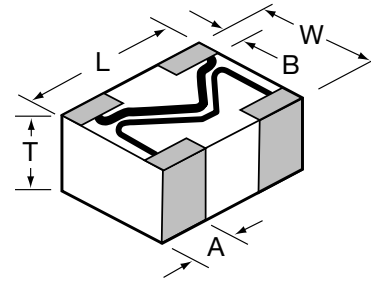

	0805
L	2.03±0.1 (0.080±0.004)
W	1.55±0.1 (0.061±0.004)
T	0.98±0.1 (0.039±0.004)
A	0.56±0.25 (0.022±0.010)
B	0.35±0.15 (0.014±0.006)

### HOW TO ORDER

<b>CP</b> T	<b>0805</b> T	<b>A</b> T	<b>0902</b> T	<b>A</b> T	<b>S</b> T	<b>TR</b> T
<b>Style</b> Directional Coupler	<b>Size</b> 0805	<b>Layout Type</b> (see layout types)	<b>Frequency</b> MHz	<b>Sub Type</b> (see layout sub-types)	<b>Termination Code</b> W = Nickel/Solder (Sn/Pb) **S = Nickel / Lead Free Solder (Sn100)	<b>Packaging Code</b> TR = Tape and Reel

Not RoHS Compliant

LEAD-FREE  
LEAD-FREE COMPATIBLE  
COMPONENT

RoHS  
COMPLIANT

For RoHS compliant products, please select correct termination style.

\*\*RoHS compliant

### QUALITY INSPECTION

Finished parts are 100% tested for electrical parameters and visual characteristics. Each production lot is evaluated on a sample basis for:

- Static Humidity: 85°C, 85% RH, 160 hours
- Endurance: 125°C, I<sub>R</sub>, 4 hours

### TERMINATION

Nickel/Solder coating (Sn, Pb) compatible with automatic soldering technologies: reflow, wave soldering, vapor phase and manual.

### Recommended Pad Layout Dimensions mm (inches)

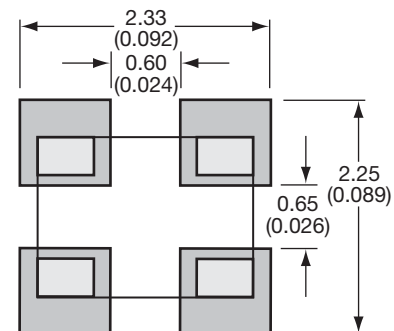

NOTE: Components must be mounted on the board with the white (Alumina) side DOWN.

# Thin-Film Directional Couplers



## CP0805 Layout Types

### LAYOUT

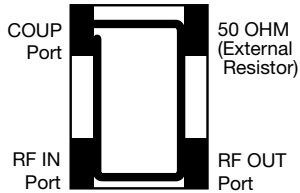

### Sn100 LAYOUT

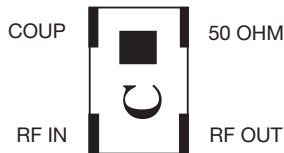

Type: A  
Sub-Type: A

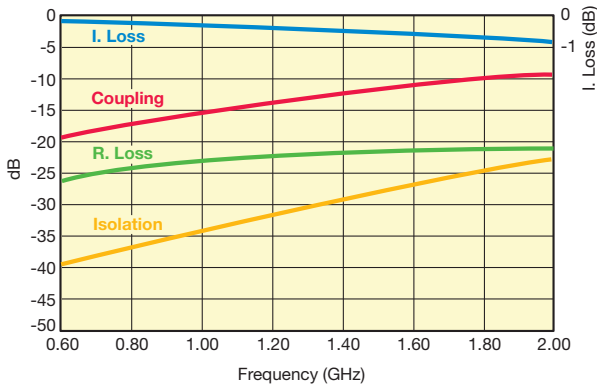

### LAYOUT

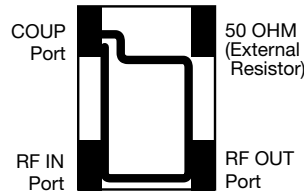

### Sn100 LAYOUT



Type: A  
Sub-Type: B

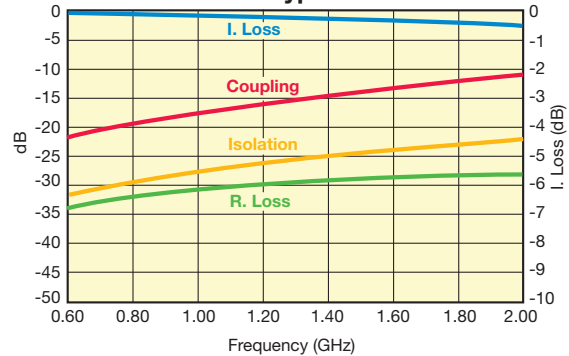

Application	P/N Examples	Frequency Band [MHz]	Coupling [dB]	I. Loss max	VSWR max
AMPS	CP0805A0836AW	824 - 849	16.5±1	0.25	1.2
	CP0805A0881AW	869 - 894	16±1		
GSM	CP0805A0902AW	890 - 915	16±1		
	CP0805A0947AW	935 - 960	15.5±1		
E-GSM	CP0805A0897AW	880 - 915	16±1		
	CP0805A0942AW	925 - 960	15.5±1		
PDC	CP0805A1441AW	1429 - 1453	12±1	0.5	1.3
PCN	CP0805A1747AW	1710 - 1785	10.5±1	0.8	1.4
	CP0805A1842AW	1805 - 1880	10±1		
PCS	CP0805A1880AW	1850 - 1910	9.5±1	0.7	1.4
	CP0805A1960AW	1930 - 1990	9.5±1		
PHP	CP0805A1907AW	1895 - 1920	9.5±1	0.6	
DECT	CP0805A1890AW	1880 - 1900	9.5±1	0.6	

Application	P/N Examples	Frequency Band [MHz]	Coupling [dB]	I. Loss max	VSWR max
AMPS	CP0805A0836BW	824 - 849	19±1	0.25	1.2
	CP0805A0881BW	869 - 894	18.5±1		
GSM	CP0805A0902BW	890 - 915	18±1		
	CP0805A0947BW	935 - 960	18±1		
E-GSM	CP0805A0897BW	880 - 915	18.5±1		
	CP0805A0942BW	925 - 960	18±1		
PDC	CP0805A1441BW	1429 - 1453	14.5±1	0.35	
PCN	CP0805A1747BW	1710 - 1785	12.5±1	0.5	1.4
	CP0805A1842BW	1805 - 1880	12.5±1		
PCS	CP0805A1880BW	1850 - 1910	12±1	0.6	1.4
	CP0805A1960BW	1930 - 1990	11.5±1		
PHP	CP0805A1907BW	1895 - 1920	12±1	0.6	
DECT	CP0805A1890BW	1880 - 1900	12±1	0.6	
Wireless LAN	CP0805A2442BW	2400 - 2484	10±1	0.9	

### LAYOUT

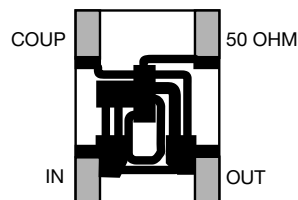

### Sn100 LAYOUT

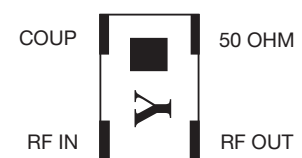

Type: A  
Sub-Type: C

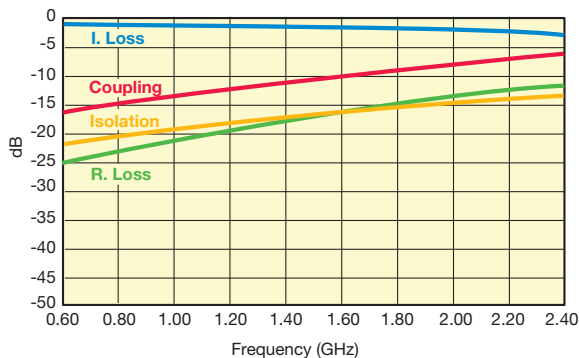

Application	P/N Examples	Frequency Band [MHz]	Coupling [dB]	I. Loss max	VSWR max
AMPS	CP0805A0836CW	824 - 849	14±1	0.5	1.4
	CP0805A0881CW	869 - 894	13.5±1		
GSM	CP0805A0902CW	890 - 915	13.5±1		
	CP0805A0947CW	935 - 960	13±1		
E-GSM	CP0805A0897CW	880 - 915	13.5±1		
	CP0805A0942CW	925 - 960	13±1		
PDC	CP0805A1441CW	1429 - 1453	9.5±1	1.15	1.8
PCN	CP0805A1747CW	1710 - 1785	8±1	1.6	2.2
	CP0805A1842CW	1805 - 1880	8±1		
PCS	CP0805A1880CW	1850 - 1910	7.5±1	1.75	2.2
	CP0805A1960CW	1930 - 1990	7.5±1		
PHP	CP0805A1907CW	1895 - 1920	7.5±1	2.5	
DECT	CP0805A1890CW	1880 - 1900	7.5±1	2.5	
Wireless LAN	CP0805A2442CW	2400 - 2484	6±1	2.5	

Important: Couplers can be used at any frequency within the indicated range.



# Thin-Film Directional Couplers



## CP0805 Layout Types

### LAYOUT

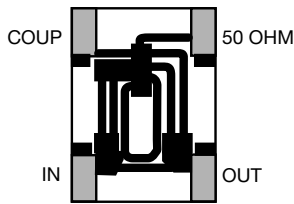

### Sn100 LAYOUT

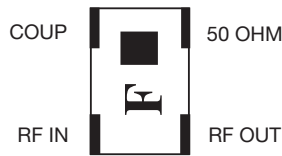

Type: A  
Sub-Type: D

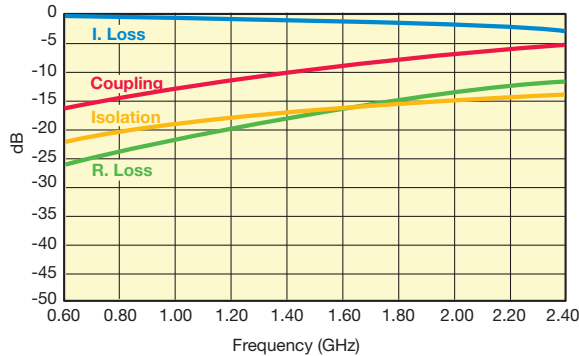

Application	P/N Examples	Frequency Band [MHz]	Coupling [dB]	I. Loss max	VSWR max
AMPS	CP0805A0836DW	824 - 849	13.0±1	0.5	1.4
	CP0805A0881DW	869 - 894	12.5±1		
GSM	CP0805A0902DW	890 - 915	12.5±1	1.85	1.8
	CP0805A0947DW	935 - 960	12±1		
E-GSM	CP0805A0897DW	880 - 915	12.5±1	2.15	2.1
	CP0805A0942DW	925 - 960	12±1		
PDC	CP0805A1441DW	1429 - 1453	8.5±1	1.25	1.8
PCN	CP0805A1747DW	1710 - 1785	7±1	1.85	2.2
	CP0805A1842DW	1805 - 1880	7±1		
PCS	CP0805A1880DW	1850 - 1910	7±1	2.4	2.1
	Cp0805A1960DW	1930 - 1990	6.5±1		
PHP	CP0805A1907DW	1895 - 1920	6.5±1	1.85	1.8
DECT	CP0805A1890DW	1880 - 1900	7±1	1.85	1.8
Wireless LAN	CP0805A2442DW	2400 - 2484	5.5±1	2.4	2.1

### LAYOUT

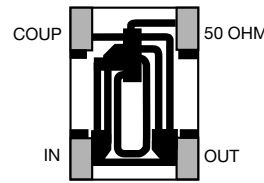

### Sn100 LAYOUT



Type: A  
Sub-Type: E

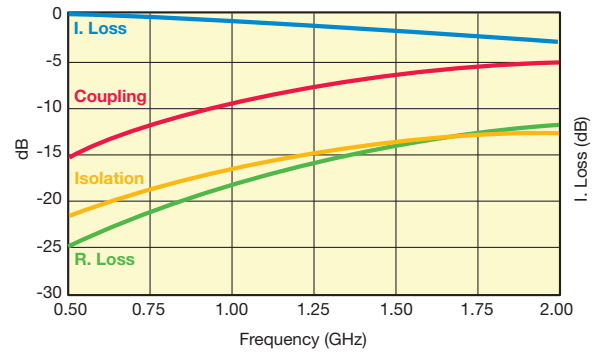

Application	P/N Examples	Frequency Band [MHz]	Coupling [dB]	I. Loss max	VSWR max
AMPS	CP0805A0836EW	824 - 849	11±1	0.85	1.4
	CP0805A0881EW	869 - 894	10.5±1		
GSM	CP0805A0902EW	890 - 915	10.5±1	1.8	1.8
	CP0805A0947EW	935 - 960	10±1		
E-GSM	CP0805A0897EW	880 - 915	10.5±1	2.7	2.2
	CP0805A0942EW	925 - 960	10±1		
PDC	CP0805A1441EW	1429 - 1453	7±1	1.8	1.8
PCN	CP0805A1747EW	1710 - 1785	5.5±1	3.15	2.4
	CP0805A1842EW	1805 - 1880	5.5±1		
PCS	CP0805A1880EW	1850 - 1910	5±1	4.2	2.4
	Cp0805A1960EW	1930 - 1990	5±1		
PHP	CP0805A1907EW	1895 - 1920	5±1	1.85	1.8
DECT	CP0805A1890EW	1880 - 1900	5±1	1.85	1.8
Wireless LAN	CP0805A2442EW	2400 - 2484	4±1	2.4	2.1

Type: B  
Sub-Type: A

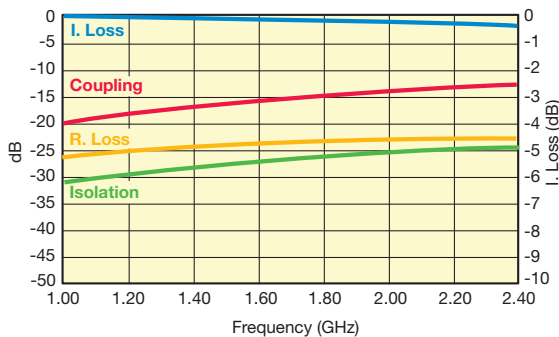

### LAYOUT

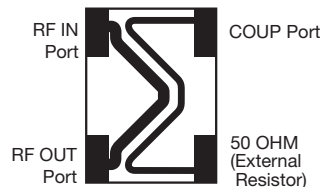

### Sn100 LAYOUT

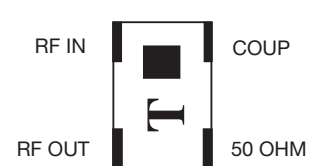

Application	P/N Examples	Frequency Band [MHz]	Coupling [dB]	I. Loss max	VSWR max
AMPS	CP0805B0836AW	824 - 849	21.5±1	0.25	1.2
	CP0805B0881AW	869 - 894	21±1		
GSM	CP0805B0902AW	890 - 915	21±1	0.3	1.2
	CP0805B0947AW	935 - 960	20.5±1		
E-GSM	CP0805B0897AW	880 - 915	21±1	0.4	1.2
	CP0805B0942AW	925 - 960	20.5±1		
PDC	CP0805B1441AW	1429 - 1453	17±1	0.3	1.2
PCN	CP0805B1747AW	1710 - 1785	15.5±1	0.3	1.2
	Cp0805B1842AW	1805 - 1880	15.5±1		
PCS	CP0805B1880AW	1850 - 1910	15±1	0.4	1.2
	CP0805B1960AW	1930 - 1990	14.5±1		
PHP	CP0805B1907AW	1895 - 1920	15±1	0.3	1.2
DECT	CP0805B1890AW	1880 - 1900	15±1	0.3	1.2
Wireless LAN	CP0805B2442AW	2400 - 2484	13±1	0.4	1.2

Important: Couplers can be used at any frequency within the indicated range.

# Thin-Film Directional Couplers



## CP0805 Layout Types



Type: B  
Sub-Type: B

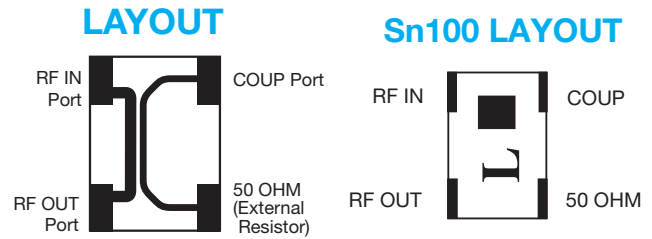
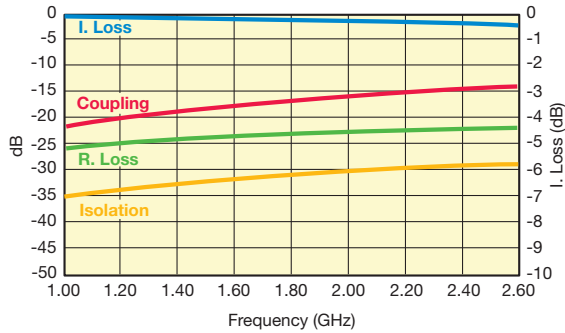

Type: B  
Sub-Type: C

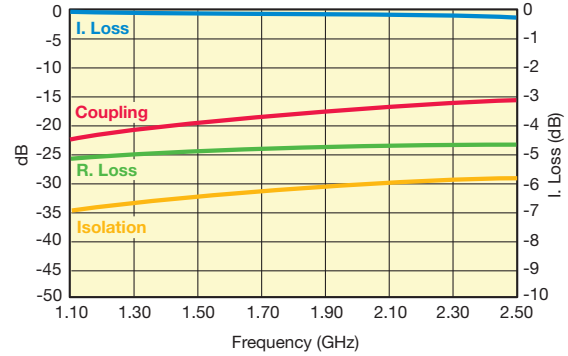

Application	P/N Examples	Frequency Band [MHz]	Coupling [dB]	I. Loss max	VSWR max
AMPS	CP0805B0836BW	824 - 849	23.5±1	0.25	1.2
	CP0805B0881BW	869 - 894	23±1		
GSM	CP0805B0902BW	890 - 915	22.5±1		
	CP0805B0947BW	935 - 960	22±1		
E-GSM	CP0805B0897BW	880 - 915	23±1		
	CP0805B0942BW	925 - 960	22±1		
PDC	CP0805B1441BW	1429 - 1453	18.5±1		
PCN	CP0805B1747BW	1710 - 1785	17±1		
	CP0805B1842BW	1805 - 1880	16.5±1		
PCS	CP0805B1880BW	1850 - 1910	16.5±1		
	CP0805B1960BW	1930 - 1990	16±1		
PHP	CP0805B1907BW	1895 - 1920	16±1		
DECT	CP0805B1890BW	1880 - 1900	16±1		
Wireless LAN	CP0805B2442BW	2400 - 2484	14±1	0.4	

Application	P/N Examples	Frequency Band [MHz]	Coupling [dB]	I. Loss max	VSWR max
AMPS	CP0805B0836CW	824 - 849	25±1	0.25	1.2
	CP0805B0881CW	869 - 894	24.5±1		
GSM	CP0805B0902CW	890 - 915	24±1		
	CP0805B0947CW	935 - 960	24±1		
E-GSM	CP0805B0897CW	880 - 915	24.5±1		
	CP0805B0942CW	925 - 960	24±1		
PDC	CP0805B1441CW	1429 - 1453	20±1		
PCN	CP0805B1747CW	1710 - 1785	18.5±1		
	CP0805B1842CW	1805 - 1880	18.5±1		
PCS	CP0805B1880CW	1850 - 1910	18±1		
	CP0805B1960CW	1930 - 1990	17.5±1		
PHP	CP0805B1907CW	1895 - 1920	18±1		
DECT	CP0805B1890CW	1880 - 1900	18±1		
Wireless LAN	CP0805B2442CW	2400 - 2484	16±1	0.4	

Important: Couplers can be used at any frequency within the indicated range.



# Thin-Film Directional Couplers



## CP0805 Layout Types

### VHF DIRECTIONAL COUPLER

CP0805L0155ASTR

Sn100 LAYOUT



P/N	Frequency [MHz]	Coupling [dB]	R. Loss [dB]	I. Loss max [dB]	Directivity [dB]
CP0805L0155ASTR	155	17.1±1	24	0.35	22



### UHF DIRECTIONAL COUPLER

CP0805L0436BSTR

Sn100 LAYOUT



P/N	Frequency [MHz]	Coupling [dB]	R. Loss [dB]	I. Loss max [dB]	Directivity [dB]
CP0805L0436BSTR	403-470	15.85±1	35	0.25	22

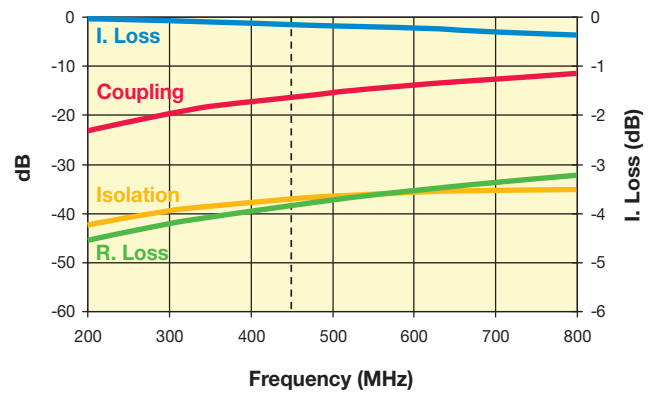

Important: Couplers can be used at any frequency within the indicated range.

# Thin-Film Directional Couplers



## CP0805 and CP0603 Test Jig

### ITF TEST JIG FOR COUPLER TYPES 0805 AND 0603 SMD

#### GENERAL DESCRIPTION

This jig is designed for the testing of CP0805 and CP0603 series Directional Couplers using a vector network analyzer. It consists of a FR4 multi-layer substrate, having 50Ω microstrips as conducting lines and a ground plane in the middle layer, located at a distance of 0.2mm from the microstrips.

The connectors are SMA type (female), 'Johnson Components Inc.' Product P/N: 142-0701-881.

The jig is designed for a full 2-port calibration. LOAD calibration can be done either by a 50Ω SMA termination, or by soldering a 50Ω chip resistor at the 50Ω ports.

#### MEASUREMENT PROCEDURE

When measuring a component, it can be either soldered or pressed by a non-metallic stick until all four ports touch the appropriate pads. To measure the coupling (and the R. Loss) place the component on the Port 1 & Port 2 pads. Use two SMA 50Ω terminations (male) to terminate the ports, which are not connected to the network analyzer, and connect the network analyzer to the two ports. A 90° rotation of the component on its pads allows measuring a second parameter (I. Loss).

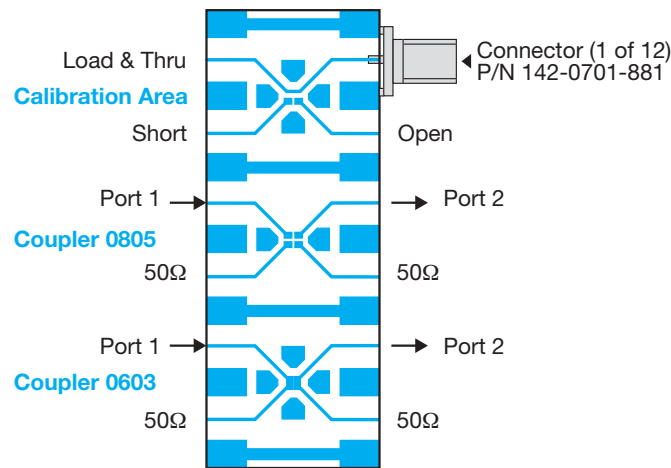

### CP0805 SERIES DIRECTIONAL COUPLERS

#### Orientation and Tape and Reel Packaging Specification

(Top View)

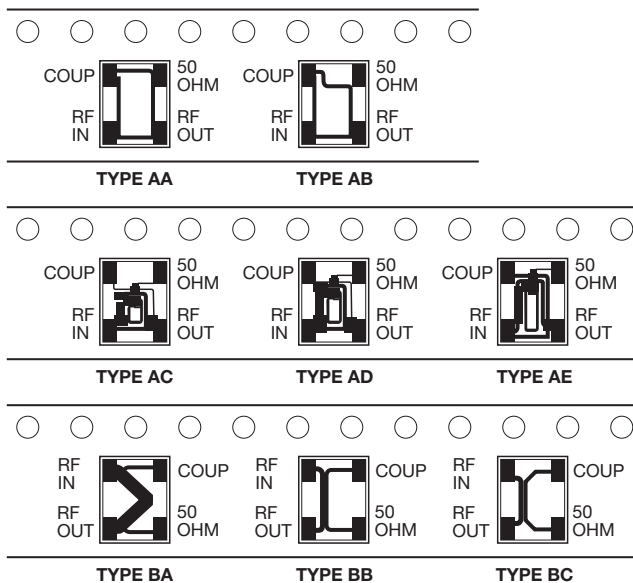

The parts should be mounted on the PCB with White (Alumina) side down and the "dark" side up.

#### CP0805xxxxxSTR (Sn100)

(Top View)

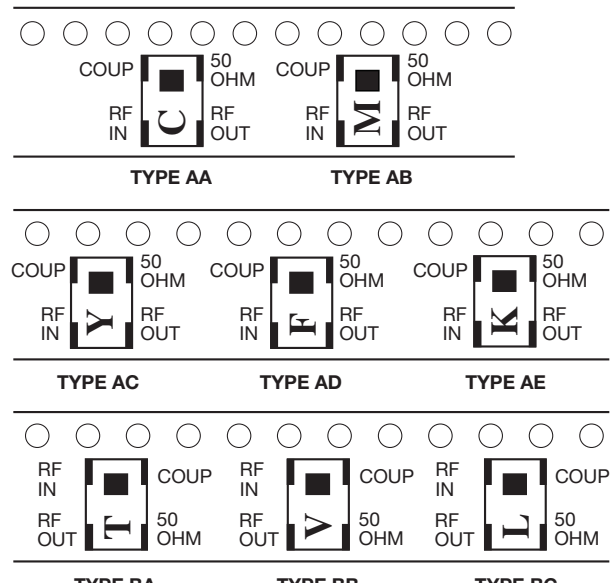

The parts should be mounted on the PCB with printed side up.





Компания «ЭлектроПласт» предлагает заключение долгосрочных отношений при поставках импортных электронных компонентов на взаимовыгодных условиях!

Наши преимущества:

- Оперативные поставки широкого спектра электронных компонентов отечественного и импортного производства напрямую от производителей и с крупнейших мировых складов;
- Поставка более 17-ти миллионов наименований электронных компонентов;
- Поставка сложных, дефицитных, либо снятых с производства позиций;
- Оперативные сроки поставки под заказ (от 5 рабочих дней);
- Экспресс доставка в любую точку России;
- Техническая поддержка проекта, помощь в подборе аналогов, поставка прототипов;
- Система менеджмента качества сертифицирована по Международному стандарту ISO 9001;
- Лицензия ФСБ на осуществление работ с использованием сведений, составляющих государственную тайну;
- Поставка специализированных компонентов (Xilinx, Altera, Analog Devices, Intersil, Interpoint, Microsemi, Aeroflex, Peregrine, Syfer, Eurofarad, Texas Instrument, Miteq, Cobham, E2V, MA-COM, Hittite, Mini-Circuits, General Dynamics и др.);

Помимо этого, одним из направлений компании «ЭлектроПласт» является направление «Источники питания». Мы предлагаем Вам помощь Конструкторского отдела:

- Подбор оптимального решения, техническое обоснование при выборе компонента;
- Подбор аналогов;
- Консультации по применению компонента;
- Поставка образцов и прототипов;
- Техническая поддержка проекта;
- Защита от снятия компонента с производства.



#### Как с нами связаться

**Телефон:** 8 (812) 309 58 32 (многоканальный)

**Факс:** 8 (812) 320-02-42

**Электронная почта:** [org@eplast1.ru](mailto:org@eplast1.ru)

**Адрес:** 198099, г. Санкт-Петербург, ул. Калинина, дом 2, корпус 4, литера А.