

Thin-Film Directional Couplers



CP0805 SMD Type

GENERAL DESCRIPTION ITF (Integrated Thin-Film) TECHNOLOGY

The ITF SMD Coupler is based on thin-film multilayer technology. The technology provides a miniature part with excellent high frequency performance and rugged construction for reliable automatic assembly.

The ITF Coupler is offered in a variety of frequency bands compatible with various types of high frequency wireless systems.

FEATURES

- Small Size: 0805
- Frequency Range: 800MHz - 3GHz
- Characteristic Impedance: 50Ω
- Operating / Storage Temp.: -40°C to +85°C
- Power Rating: 3W Continuous
- Low Profile
- Rugged Construction
- Taped and Reeled

APPLICATIONS

- Mobile Communications
- Satellite TV Receivers
- GPS
- Vehicle Location Systems
- Wireless LAN's

DIMENSIONS: (Top View) millimeters (inches)



| | 0805 |
|---|-------------------------|
| L | 2.03±0.1 (0.080±0.004) |
| W | 1.55±0.1 (0.061±0.004) |
| T | 0.98±0.1 (0.039±0.004) |
| A | 0.56±0.25 (0.022±0.010) |
| B | 0.35±0.15 (0.014±0.006) |

HOW TO ORDER

| | | | | | | |
|---|---|---|---|--|--|---|
| CP ↓ Style Directional Coupler | 0805 ↓ Size 0805 | A ↓ Layout Type (see layout types) | 0902 ↓ Frequency MHz | A ↓ Sub Type (see layout sub-types) | S ↓ Termination Code W = Nickel/Solder (Sn/Pb) **S = Nickel / Lead Free Solder (Sn100) | TR ↓ Packaging Code TR = Tape and Reel |
|---|---|---|---|--|--|---|

Not RoHS Compliant



LEAD-FREE
LEAD-FREE COMPATIBLE
COMPONENT



RoHS
COMPLIANT

For RoHS compliant products, please select correct termination style.

**RoHS compliant

QUALITY INSPECTION

Finished parts are 100% tested for electrical parameters and visual characteristics. Each production lot is evaluated on a sample basis for:

- Static Humidity: 85°C, 85% RH, 160 hours
- Endurance: 125°C, I_R, 4 hours

TERMINATION

Nickel/Solder coating (Sn, Pb) compatible with automatic soldering technologies: reflow, wave soldering, vapor phase and manual.

Recommended Pad Layout Dimensions mm (inches)



NOTE: Components must be mounted on the board with the white (Alumina) side DOWN.

Thin-Film Directional Couplers



CP0805 Layout Types

LAYOUT



Sn100 LAYOUT



Type: A
Sub-Type: A

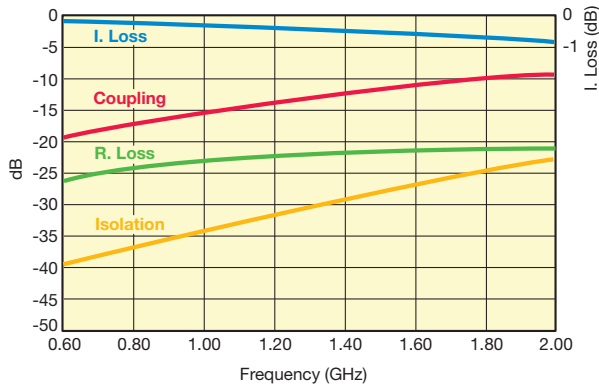

LAYOUT

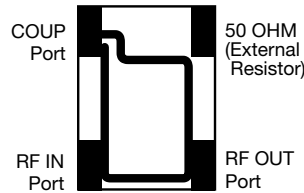

Sn100 LAYOUT



Type: A
Sub-Type: B

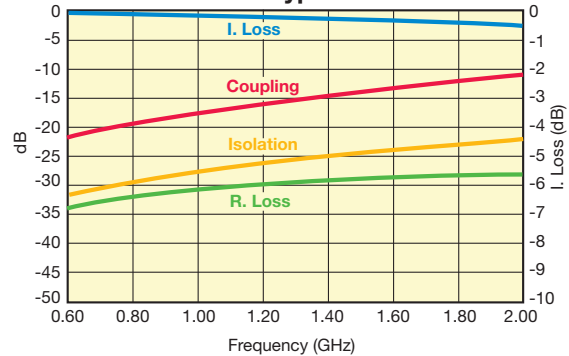

| Application | P/N Examples | Frequency Band [MHz] | Coupling [dB] | I. Loss max | VSWR max |
|-------------|---------------|----------------------|---------------|-------------|----------|
| AMPS | CP0805A0836AW | 824 - 849 | 16.5±1 | 0.25 | 1.2 |
| | CP0805A0881AW | 869 - 894 | 16±1 | | |
| GSM | CP0805A0902AW | 890 - 915 | 16±1 | | |
| | CP0805A0947AW | 935 - 960 | 15.5±1 | | |
| E-GSM | CP0805A0897AW | 880 - 915 | 16±1 | | |
| | CP0805A0942AW | 925 - 960 | 15.5±1 | | |
| PDC | CP0805A1441AW | 1429 - 1453 | 12±1 | 0.5 | 1.3 |
| PCN | CP0805A1747AW | 1710 - 1785 | 10.5±1 | 0.8 | 1.4 |
| | CP0805A1842AW | 1805 - 1880 | 10±1 | | |
| PCS | CP0805A1880AW | 1850 - 1910 | 9.5±1 | 0.7 | 1.4 |
| | CP0805A1960AW | 1930 - 1990 | 9.5±1 | | |
| PHP | CP0805A1907AW | 1895 - 1920 | 9.5±1 | 0.6 | |
| DECT | CP0805A1890AW | 1880 - 1900 | 9.5±1 | 0.6 | |

| Application | P/N Examples | Frequency Band [MHz] | Coupling [dB] | I. Loss max | VSWR max |
|--------------|---------------|----------------------|---------------|-------------|----------|
| AMPS | CP0805A0836BW | 824 - 849 | 19±1 | 0.25 | 1.2 |
| | CP0805A0881BW | 869 - 894 | 18.5±1 | | |
| GSM | CP0805A0902BW | 890 - 915 | 18±1 | | |
| | CP0805A0947BW | 935 - 960 | 18±1 | | |
| E-GSM | CP0805A0897BW | 880 - 915 | 18.5±1 | | |
| | CP0805A0942BW | 925 - 960 | 18±1 | | |
| PDC | CP0805A1441BW | 1429 - 1453 | 14.5±1 | 0.35 | |
| PCN | CP0805A1747BW | 1710 - 1785 | 12.5±1 | 0.5 | 1.4 |
| | CP0805A1842BW | 1805 - 1880 | 12.5±1 | | |
| PCS | CP0805A1880BW | 1850 - 1910 | 12±1 | 0.7 | 1.4 |
| | CP0805A1960BW | 1930 - 1990 | 11.5±1 | | |
| PHP | CP0805A1907BW | 1895 - 1920 | 12±1 | 0.6 | |
| DECT | CP0805A1890BW | 1880 - 1900 | 12±1 | 0.6 | |
| Wireless LAN | CP0805A2442BW | 2400 - 2484 | 10±1 | 0.9 | |

LAYOUT

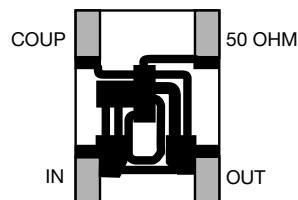

Sn100 LAYOUT



Type: A
Sub-Type: C

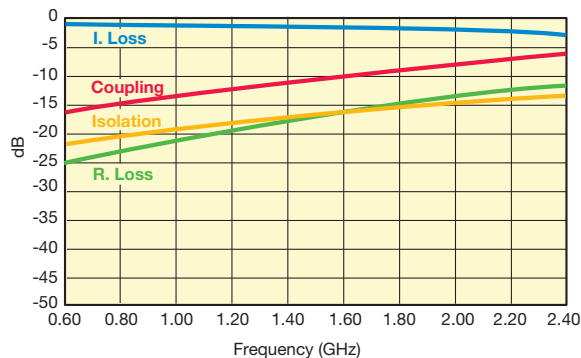

| Application | P/N Examples | Frequency Band [MHz] | Coupling [dB] | I. Loss max | VSWR max |
|--------------|---------------|----------------------|---------------|-------------|----------|
| AMPS | CP0805A0836CW | 824 - 849 | 14±1 | 0.5 | 1.4 |
| | CP0805A0881CW | 869 - 894 | 13.5±1 | | |
| GSM | CP0805A0902CW | 890 - 915 | 13.5±1 | | |
| | CP0805A0947CW | 935 - 960 | 13±1 | | |
| E-GSM | CP0805A0897CW | 880 - 915 | 13.5±1 | | |
| | CP0805A0942CW | 925 - 960 | 13±1 | | |
| PDC | CP0805A1441CW | 1429 - 1453 | 9.5±1 | 1.15 | 1.8 |
| PCN | CP0805A1747CW | 1710 - 1785 | 8±1 | 1.6 | 2.2 |
| | CP0805A1842CW | 1805 - 1880 | 8±1 | | |
| PCS | CP0805A1880CW | 1850 - 1910 | 7.5±1 | 1.75 | 2.2 |
| | CP0805A1960CW | 1930 - 1990 | 7.5±1 | | |
| PHP | CP0805A1907CW | 1895 - 1920 | 7.5±1 | 2.5 | |
| DECT | CP0805A1890CW | 1880 - 1900 | 7.5±1 | 2.5 | |
| Wireless LAN | CP0805A2442CW | 2400 - 2484 | 6±1 | 2.5 | |

Important: Couplers can be used at any frequency within the indicated range.



Thin-Film Directional Couplers



CP0805 Layout Types

LAYOUT



Sn100 LAYOUT



Type: A
Sub-Type: D



LAYOUT



Sn100 LAYOUT



Type: A
Sub-Type: E



3

| Application | P/N Examples | Frequency Band [MHz] | Coupling [dB] | I. Loss max | VSWR max |
|--------------|---------------|----------------------|---------------|-------------|----------|
| AMPS | CP0805A0836DW | 824 - 849 | 13.0±1 | 0.5 | 1.4 |
| | CP0805A0881DW | 869 - 894 | 12.5±1 | | |
| GSM | CP0805A0902DW | 890 - 915 | 12.5±1 | 1.85 | 1.8 |
| | CP0805A0947DW | 935 - 960 | 12±1 | | |
| E-GSM | CP0805A0897DW | 880 - 915 | 12.5±1 | 2.15 | 2.1 |
| | CP0805A0942DW | 925 - 960 | 12±1 | | |
| PDC | CP0805A1441DW | 1429 - 1453 | 8.5±1 | 1.25 | 1.8 |
| PCN | CP0805A1747DW | 1710 - 1785 | 7±1 | 1.85 | 2.2 |
| | CP0805A1842DW | 1805 - 1880 | 7±1 | | |
| PCS | CP0805A1880DW | 1850 - 1910 | 7±1 | 2.4 | 2.4 |
| | Cp0805A1960DW | 1930 - 1990 | 6.5±1 | | |
| PHP | CP0805A1907DW | 1895 - 1920 | 6.5±1 | 1.85 | 1.8 |
| DECT | CP0805A1890DW | 1880 - 1900 | 7±1 | 2.4 | 2.1 |
| Wireless LAN | CP0805A2442DW | 2400 - 2484 | 5.5±1 | 2.4 | 2.1 |

| Application | P/N Examples | Frequency Band [MHz] | Coupling [dB] | I. Loss max | VSWR max |
|--------------|---------------|----------------------|---------------|-------------|----------|
| AMPS | CP0805A0836EW | 824 - 849 | 11±1 | 0.85 | 1.4 |
| | CP0805A0881EW | 869 - 894 | 10.5±1 | | |
| GSM | CP0805A0902EW | 890 - 915 | 10.5±1 | 1.8 | 1.8 |
| | CP0805A0947EW | 935 - 960 | 10±1 | | |
| E-GSM | CP0805A0897EW | 880 - 915 | 10.5±1 | 2.7 | 2.2 |
| | CP0805A0942EW | 925 - 960 | 10±1 | | |
| PDC | CP0805A1441EW | 1429 - 1453 | 7±1 | 1.8 | 1.8 |
| PCN | CP0805A1747EW | 1710 - 1785 | 5.5±1 | 3.15 | 2.4 |
| | CP0805A1842EW | 1805 - 1880 | 5.5±1 | | |
| PCS | CP0805A1880EW | 1850 - 1910 | 5±1 | 4.2 | 2.4 |
| | Cp0805A1960EW | 1930 - 1990 | 5±1 | | |
| PHP | CP0805A1907EW | 1895 - 1920 | 5±1 | 2.7 | 2.2 |
| DECT | CP0805A1890EW | 1880 - 1900 | 5±1 | 4.2 | 2.4 |
| Wireless LAN | CP0805A2442EW | 2400 - 2484 | 4±1 | 4.2 | 2.4 |

Type: B
Sub-Type: A



LAYOUT

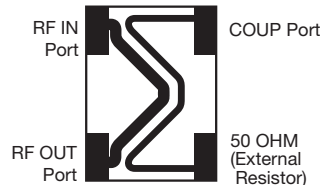

Sn100 LAYOUT

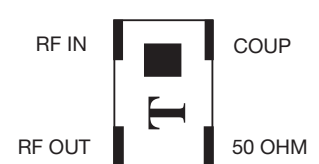

| Application | P/N Examples | Frequency Band [MHz] | Coupling [dB] | I. Loss max | VSWR max |
|--------------|---------------|----------------------|---------------|-------------|----------|
| AMPS | CP0805B0836AW | 824 - 849 | 21.5±1 | 0.25 | 1.2 |
| | CP0805B0881AW | 869 - 894 | 21±1 | | |
| GSM | CP0805B0902AW | 890 - 915 | 21±1 | 0.3 | 1.2 |
| | CP0805B0947AW | 935 - 960 | 20.5±1 | | |
| E-GSM | CP0805B0897AW | 880 - 915 | 21±1 | 0.4 | 1.2 |
| | CP0805B0942AW | 925 - 960 | 20.5±1 | | |
| PDC | CP0805B1441AW | 1429 - 1453 | 17±1 | 0.3 | 1.2 |
| PCN | CP0805B1747AW | 1710 - 1785 | 15.5±1 | 0.4 | 1.2 |
| | Cp0805B1842AW | 1805 - 1880 | 15.5±1 | | |
| PCS | CP0805B1880AW | 1850 - 1910 | 15±1 | 0.3 | 1.2 |
| | CP0805B1960AW | 1930 - 1990 | 14.5±1 | | |
| PHP | CP0805B1907AW | 1895 - 1920 | 15±1 | 0.3 | 1.2 |
| DECT | CP0805B1890AW | 1880 - 1900 | 15±1 | 0.4 | 1.2 |
| Wireless LAN | CP0805B2442AW | 2400 - 2484 | 13±1 | 0.4 | 1.2 |

Important: Couplers can be used at any frequency within the indicated range.



Thin-Film Directional Couplers



CP0805 Layout Types



Type: B
Sub-Type: B



Type: B
Sub-Type: C



| Application | P/N Examples | Frequency Band [MHz] | Coupling [dB] | I. Loss max | VSWR max |
|--------------|---------------|----------------------|---------------|-------------|----------|
| AMPS | CP0805B0836BW | 824 - 849 | 23.5±1 | 0.25 | 1.2 |
| | CP0805B0881BW | 869 - 894 | 23±1 | | |
| GSM | CP0805B0902BW | 890 - 915 | 22.5±1 | | |
| | CP0805B0947BW | 935 - 960 | 22±1 | | |
| E-GSM | CP0805B0897BW | 880 - 915 | 23±1 | | |
| | CP0805B0942BW | 925 - 960 | 22±1 | | |
| PDC | CP0805B1441BW | 1429 - 1453 | 18.5±1 | | |
| PCN | CP0805B1747BW | 1710 - 1785 | 17±1 | | |
| | CP0805B1842BW | 1805 - 1880 | 16.5±1 | | |
| PCS | CP0805B1880BW | 1850 - 1910 | 16.5±1 | | |
| | CP0805B1960BW | 1930 - 1990 | 16±1 | | |
| PHP | CP0805B1907BW | 1895 - 1920 | 16±1 | | |
| DECT | CP0805B1890BW | 1880 - 1900 | 16±1 | | |
| Wireless LAN | CP0805B2442BW | 2400 - 2484 | 14±1 | 0.4 | |

| Application | P/N Examples | Frequency Band [MHz] | Coupling [dB] | I. Loss max | VSWR max |
|--------------|---------------|----------------------|---------------|-------------|----------|
| AMPS | CP0805B0836CW | 824 - 849 | 25±1 | 0.25 | 1.2 |
| | CP0805B0881CW | 869 - 894 | 24.5±1 | | |
| GSM | CP0805B0902CW | 890 - 915 | 24±1 | | |
| | CP0805B0947CW | 935 - 960 | 24±1 | | |
| E-GSM | CP0805B0897CW | 880 - 915 | 24.5±1 | | |
| | CP0805B0942CW | 925 - 960 | 24±1 | | |
| PDC | CP0805B1441CW | 1429 - 1453 | 20±1 | | |
| PCN | CP0805B1747CW | 1710 - 1785 | 18.5±1 | | |
| | CP0805B1842CW | 1805 - 1880 | 18.5±1 | | |
| PCS | CP0805B1880CW | 1850 - 1910 | 18±1 | | |
| | CP0805B1960CW | 1930 - 1990 | 17.5±1 | | |
| PHP | CP0805B1907CW | 1895 - 1920 | 18±1 | | |
| DECT | CP0805B1890CW | 1880 - 1900 | 18±1 | | |
| Wireless LAN | CP0805B2442CW | 2400 - 2484 | 16±1 | 0.4 | |

Important: Couplers can be used at any frequency within the indicated range.



Thin-Film Directional Couplers



CP0805 Layout Types

VHF DIRECTIONAL COUPLER

CP0805L0155ASTR

Sn100 LAYOUT



| P/N | Frequency [MHz] | Coupling [dB] | R. Loss [dB] | I. Loss max [dB] | Directivity [dB] |
|-----------------|-----------------|---------------|--------------|------------------|------------------|
| CP0805L0155ASTR | 155 | 17.1±1 | 24 | 0.35 | 22 |



UHF DIRECTIONAL COUPLER

CP0805L0436BSTR

Sn100 LAYOUT



| P/N | Frequency [MHz] | Coupling [dB] | R. Loss [dB] | I. Loss max [dB] | Directivity [dB] |
|-----------------|-----------------|---------------|--------------|------------------|------------------|
| CP0805L0436BSTR | 403-470 | 15.85±1 | 35 | 0.25 | 22 |



3

Important: Couplers can be used at any frequency within the indicated range.

Thin-Film Directional Couplers



CP0805 and CP0603 Test Jig

ITF TEST JIG FOR COUPLER TYPES 0805 AND 0603 SMD

GENERAL DESCRIPTION

This jig is designed for the testing of CP0805 and CP0603 series Directional Couplers using a vector network analyzer. It consists of a FR4 multi-layer substrate, having 50Ω microstrips as conducting lines and a ground plane in the middle layer, located at a distance of 0.2mm from the microstrips.

The connectors are SMA type (female), 'Johnson Components Inc.' Product P/N: 142-0701-881.

The jig is designed for a full 2-port calibration. LOAD calibration can be done either by a 50Ω SMA termination, or by soldering a 50Ω chip resistor at the 50Ω ports.

MEASUREMENT PROCEDURE

When measuring a component, it can be either soldered or pressed by a non-metallic stick until all four ports touch the appropriate pads. To measure the coupling (and the R. Loss) place the component on the Port 1 & Port 2 pads. Use two SMA 50Ω terminations (male) to terminate the ports, which are not connected to the network analyzer, and connect the network analyzer to the two ports. A 90° rotation of the component on its pads allows measuring a second parameter (I. Loss).



CP0805 SERIES DIRECTIONAL COUPLERS

Orientation and Tape and Reel Packaging Specification

(Top View)



The parts should be mounted on the PCB with White (Alumina) side down and the "dark" side up.

CP0805xxxxxxSTR (Sn100)

(Top View)

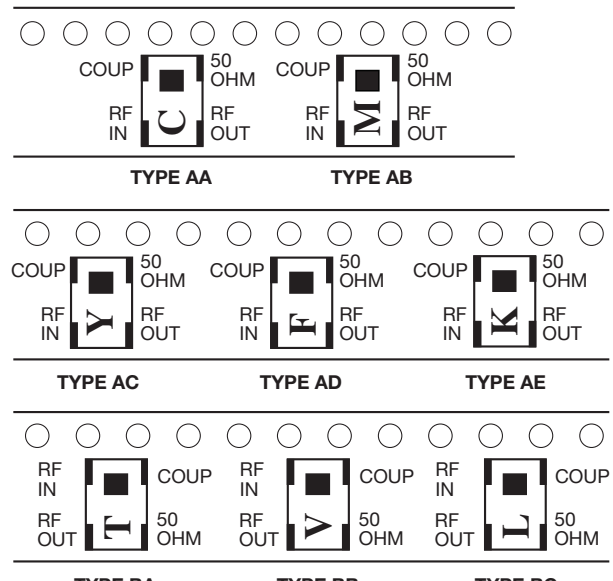

The parts should be mounted on the PCB with printed side up.





Компания «ЭлектроПласт» предлагает заключение долгосрочных отношений при поставках импортных электронных компонентов на взаимовыгодных условиях!

Наши преимущества:

- Оперативные поставки широкого спектра электронных компонентов отечественного и импортного производства напрямую от производителей и с крупнейших мировых складов;
- Поставка более 17-ти миллионов наименований электронных компонентов;
- Поставка сложных, дефицитных, либо снятых с производства позиций;
- Оперативные сроки поставки под заказ (от 5 рабочих дней);
- Экспресс доставка в любую точку России;
- Техническая поддержка проекта, помощь в подборе аналогов, поставка прототипов;
- Система менеджмента качества сертифицирована по Международному стандарту ISO 9001;
- Лицензия ФСБ на осуществление работ с использованием сведений, составляющих государственную тайну;
- Поставка специализированных компонентов (Xilinx, Altera, Analog Devices, Intersil, Interpoint, Microsemi, Aeroflex, Peregrine, Syfer, Eurofarad, Texas Instrument, Miteq, Cobham, E2V, MA-COM, Hittite, Mini-Circuits, General Dynamics и др.);

Помимо этого, одним из направлений компании «ЭлектроПласт» является направление «Источники питания». Мы предлагаем Вам помощь Конструкторского отдела:

- Подбор оптимального решения, техническое обоснование при выборе компонента;
- Подбор аналогов;
- Консультации по применению компонента;
- Поставка образцов и прототипов;
- Техническая поддержка проекта;
- Защита от снятия компонента с производства.



Как с нами связаться

Телефон: 8 (812) 309 58 32 (многоканальный)

Факс: 8 (812) 320-02-42

Электронная почта: org@eplast1.ru

Адрес: 198099, г. Санкт-Петербург, ул. Калинина, дом 2, корпус 4, литера А.