Step-Up DC_DC Converter with voltage regulator and detector

NO.EA-237-160330

OUTLINE

RP600K series are high efficiency, current mode step-up DC-DC converter ICs with a voltage regulator and a voltage detector. This converter starts up of low voltage (typ. 0.8V) operation from one or two alkaline or nickel-metal-hydride (NiMH) batteries, or a single Li+ battery.

This IC consists of a reference voltage unit with soft start, error amplifiers, PWM comparator, protection circuits such as a current limit circuit, an internal switch transistor, an oscillator, and PWM/VFM mode control circuit. A low ripple high efficiency step-up DC/DC converter can be composed of RP600K series with only an inductor, a diode, divider resistors and capacitors. In terms of output voltage setting, fixed type and adjustable with external divider resistors type are available. Output voltage is from 2.3V to 5.5V.

The built-in LDO Regulator(VR) consists of a reference voltage unit, an error amplifier, output voltage setting resistor net, a short current limit circuit, an output transistor, and so on. To prevent the inrush current at start-up, soft-start function is included. The Soft-start time is typically 200 μ s. The output voltage is fixed internally and the output range is from 1.5V to 5.0V.

This IC has an MODE pin. When the MODE pin is set as "H", the DC/DC converter control becomes fixed PWM control, and the LDO becomes the fast mode. When the MODE pin is set as "L", the DC/DC converter is automatic PWM/VFM control and the LDO becomes low power mode*.

The voltage detector always turns on. The output is Nch open drain type. Since the package is DFN(PLP)2527-10, so high density mounting on board is possible. If the internal chip temperature is beyond the certain level, system reset will work, or thermal shutdown circuit is included in the IC.

*) The switch-over point is fixed internally. As for A/D version, regardless the MODE pin signal, LDO mode is always set at fast mode. As for B/C version, regardless the MODE pin signal, when the DC/DC converter is active, LDO becomes fast mode.

Functions

A version: The input power supply of the built-in voltage regulator (LDO) is the output of the built-in DC/DC converter. After the soft-start function of the DC/DC converter, the LDO starts up. The built-in voltage detector outputs "L" when the supervised level becomes lower than the set detector threshold level. The output delay circuit for release the voltage detector is also built-in and the delay time is set at typically 10ms.

B version: The input power supply of the built-in voltage regulator (LDO) and the DC/DC converter is VDD pin. Each channel is individual. The minimum operating voltage of the LDO is 2.0V. The output of the DC/DC converter is fixed internally. If the DC/DC is active, the LDO mode becomes fixed fast mode. The built-in voltage detector outputs "L" when the supervised level becomes lower than the set detector threshold level. The output delay circuit for release the voltage detector is also built-in and the delay time is set at typically 10ms.

C version: The input power supply of the built-in voltage regulator (LDO) is the output of the built-in DC/DC converter. The voltage regulator is always active. The output of the DC/DC converter is fixed internally. The built-in voltage detector outputs "L" when the supervised level becomes lower than the set detector threshold level. The output delay circuit for release the voltage detector is not included. The hysteresis range can be selected from 30% of the set voltage detector threshold to 80% of the detector threshold.

D version: The input power supply of the built-in voltage regulator (LDO) and the DC/DC converter is VDD pin. The output of the DC/DC converter is adjustable with external divider resistors. The built-in voltage detector outputs "L" when the supervised level becomes lower than the set detector threshold level. The output delay circuit for release the voltage detector is also built-in and the delay time is set at typically 10ms.

FEATURES

Step-up DC/DC converter part

- Input Voltage Range 0.8V~5.5V
- High Efficiency 87% (100mA/3.3V, $V_{IN}=1.5V$, 25°C)
- Output current 500mA/4.2V($V_{IN}=2.5V$)
- Internal Switch NMOS=0.16Ω, (if $V_{OUT1}=3.3V$)
- Output Voltage Tolerance ±2.0%
- Frequency Typ. 1.2MHz
- Output Voltage Range Fixed: Standard voltage in the range from 2.3V to 5.5V
Adjustable: 2.3V~5.5V (Recommendation range of output voltage)
- Lx peak current control function Typ. 1.4A

LDO regulator part

*Input Voltage Range (Applied to B version only) from 2.0V to 5.5V

- Output Voltage Range Fixed: Standard voltage in the range from 1.5V to 5.0V
- Output Voltage Tolerance ±1.0%
- Turn-on Speed Typ. 100μs
- Maximum Output Current Min. 500mA guaranteed (A/D version)
..... Min. 300mA guaranteed (B version)
..... Min. 150mA guaranteed (C version)

Voltage Detector Part

- Detector Threshold Range Fixed: Standard voltage in the range from 1.0V to 4.5V
- Released Output Delay Time Typ. 10ms (A/B/D version)
..... Typ. 0ms (C version)
- Detector Threshold Hysteresis Typ. 5% of the detector threshold voltage (A/B/D version)
Selectable in the range from 30% to 80% of the detector threshold voltage (C version)

Others

- Small Package DFN(PLP)2527-10
- Thermal shutdown temperature threshold $T_j=125^{\circ}C$ (A/B/D version only)
- External components $C_{IN}=10\mu F$, $C_{OUT1}=10\mu F \times 2$, $L=3.3\mu H$ (If the output of the DC/DC is 3.6V or more, 4.7μH is our recommendation value.)
..... $C_{OUT2}=2.2\mu F$ (B/C version LDO)
..... $C_{OUT2}=10\mu F$ (A/D version LDO)

APPLICATIONS

- Portable equipment such as DSC, cellular phones, electrical dictionaries, IC recorders
- Blood pressure meter
- Smoke Detector

BLOCK DIAGRAMS

RP600K0xxA

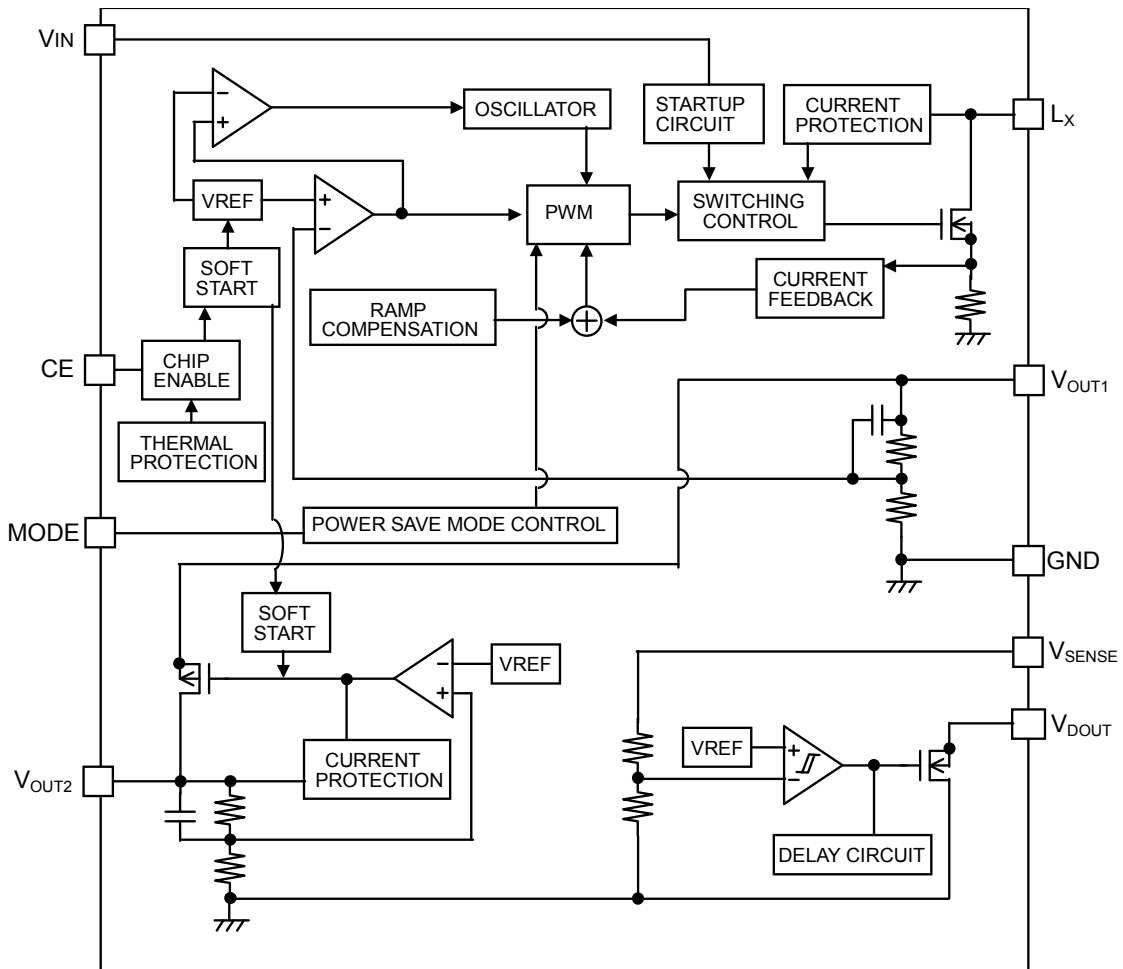

RP600K0xxB

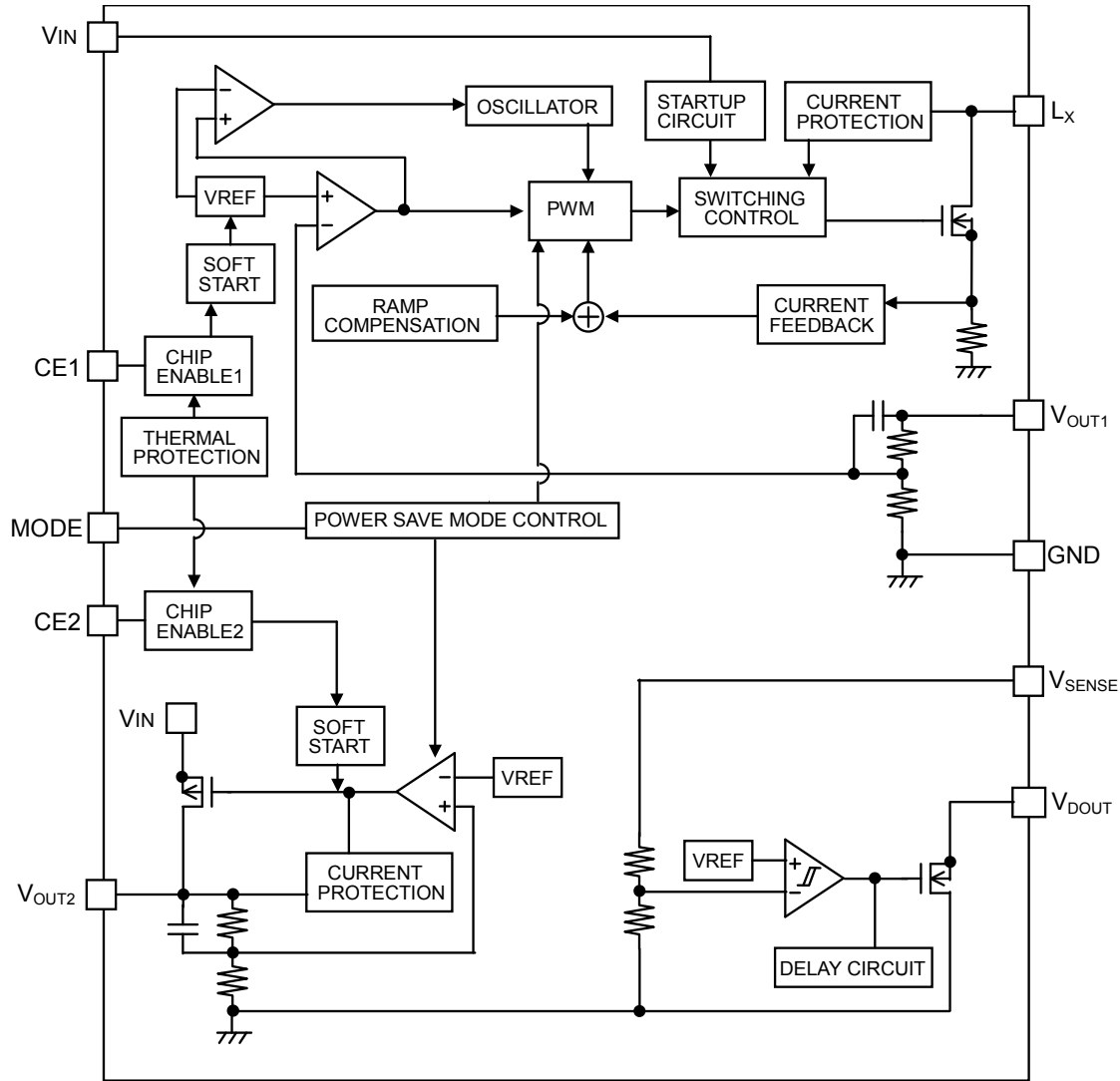

RP600K2xxC

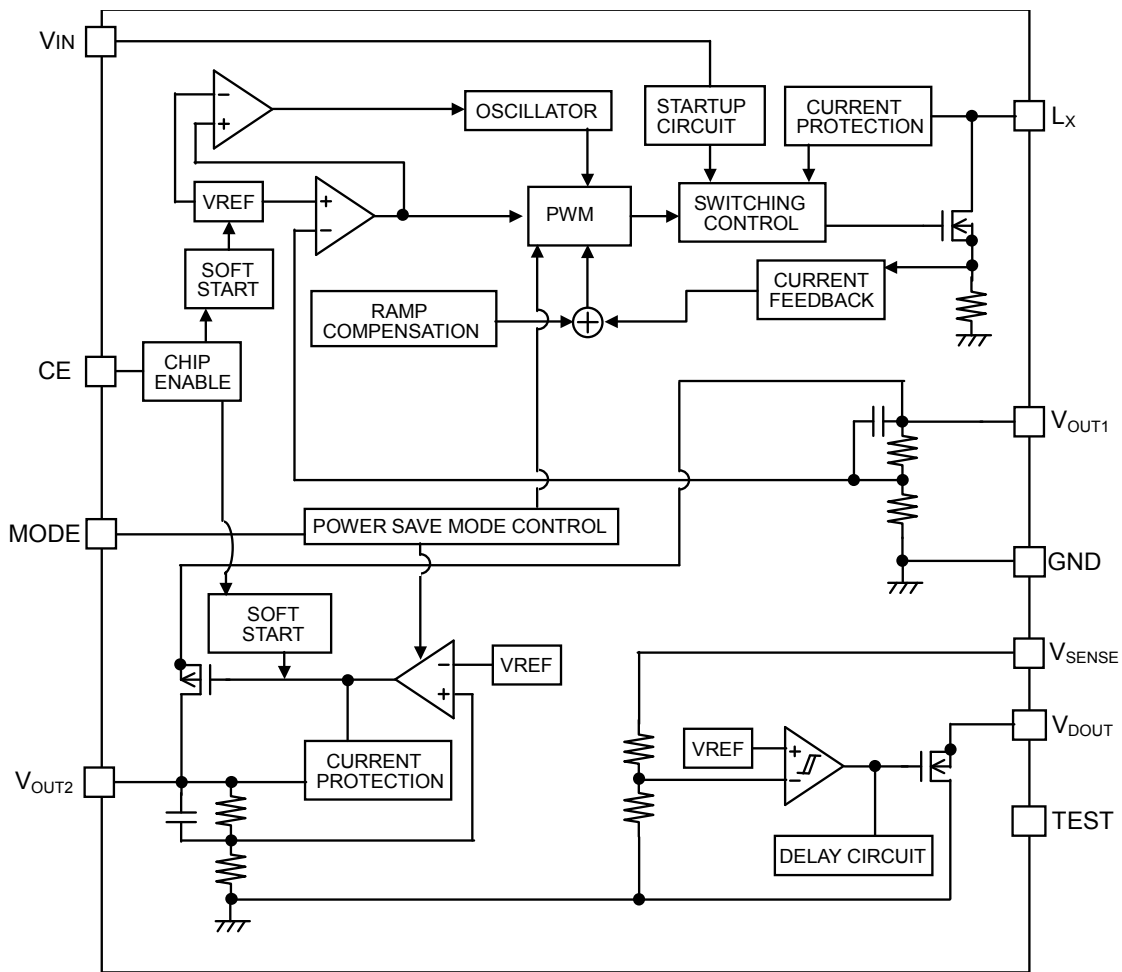

RP600K1xxD

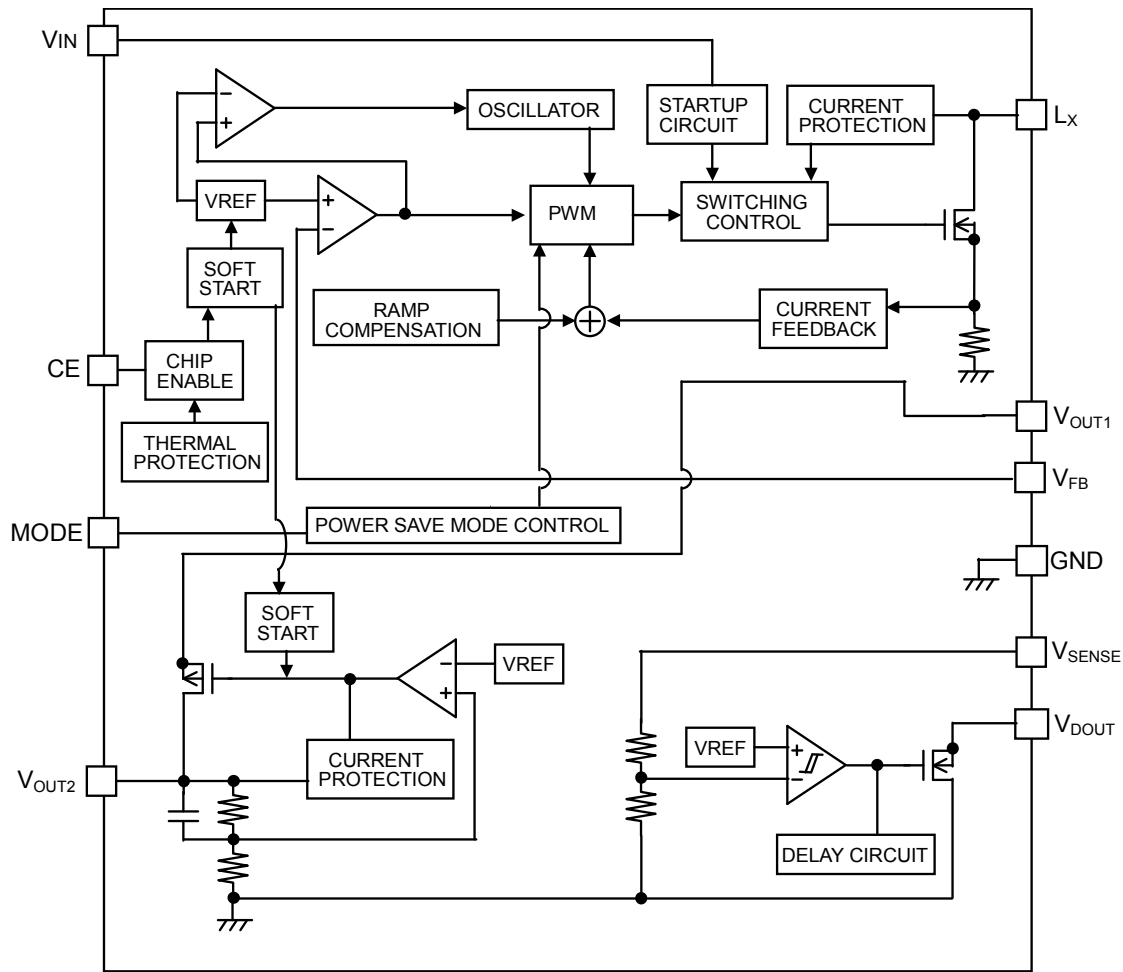

SELECTION GUIDE

In the RP600, the output voltage and function type can be selected at the user's request. The selection can be made with designating the part number as shown below:

Product Code	Package	pcs/reel	Pb free	Halogen free
RP600K0xxA-TR	DFN (PLP)2527-10	5,000 pcs	Yes	Yes
RP600K0xxB-TR		5,000 pcs	Yes	Yes
RP600K2xxC-TR		5,000 pcs	Yes	Yes
RP600K1xxD-TR		5,000 pcs	Yes	Yes

xx: Output voltage (DC/DC, LDO, Voltage detector) setting serial number *as for C version, the hysteresis range of the voltage detector setting is included. Further, refer to the voltage combination list.

Function by version

A version: DC/DC converter; Fixed output voltage.

Voltage Regulator; Power supply is the output of the DC/DC converter. Fast MODE only

Voltage Detector; "L" output at the detector threshold. With a released output delay time, the hysteresis is fixed 5% of the detector threshold.

B version: DC/DC converter; Fixed output voltage.

Voltage Regulator; Power supply is V_{IN} of this IC. When the DC/DC converter is active, regardless of the MODE signal, the mode is fixed as fast mode.

Voltage Detector; "L" output at the detector threshold. With a released output delay time, the hysteresis is fixed 5% of the detector threshold.

C version: DC/DC converter; Fixed output voltage.

Voltage Regulator; Power supply is the output of the DC/DC converter. Regardless of the CE signal, always turns on. When the DC/DC converter is active, regardless of the MODE signal, the mode is fixed as fast mode.

Voltage Detector; "L" output at the detector threshold. Without a released output delay time, the hysteresis can be set in the range from 30% to 80% of the detector threshold.

No thermal protection circuit.

D version: DC/DC converter; Adjustable output voltage.

Voltage Regulator; Power supply is the output of the DC/DC converter. Fast Mode only.

Voltage Detector; "L" output at the detector threshold. With released output delay time, the hysteresis is fixed 5% of the detector threshold.

Function version table

Ver.	DC/DC		LDO				VD	
	Output Voltage	EN pin	Output Current	Input	EN	Mode	Output Delay	Hysteresis
A	Fixed	CE	500mA (depends)	DC/DC output	CE ^{*2}	Fixed fast mode	Yes	5%
B	Fixed	CE1	300mA	VIN	CE2	DC/DC active: fast mode DC/DC off: controlled by MODE ^{*3}	Yes	5%
C ^{*1}	Fixed	CE	150mA	DC/DC output	Ever ON	DC/DC active: fast mode DC/DC off: controlled by MODE ^{*3}	No	30 ~ 80% with a step of 10%
D	Adjust	CE	500mA	DC/DC output	CE ^{*2}	Fixed fast mode	Yes	5%

*1) C version: No thermal protection circuit.

*2) Start-up sequence: LDO starts the operation after the soft-start of DC/DC.

*3) Mode pin "L": automatic shift (I_{out2}≤0.7mA: low power mode, I_{out2}≥5.0mA: fast mode)

Mode pin "H": fast mode

PIN CONFIGURATION

DFN(PLP)2527-10

**Mark Side
(Top view)**

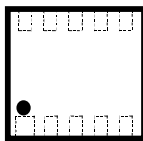

1

Bottom view

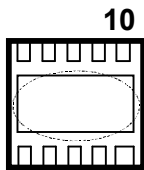

1

PIN DESCRIPTIONS

• **RP600K0xxA**

Pin Number	Symbol	Descriptions
1	V _{SENSE}	SENSE pin (for Voltage Detector)
2	V _{DOUT}	Output pin of the voltage detector, Nch open drain output
3	NC	No Connection
4	MODE	MODE pin
5	GND	Ground pin
6	Lx	DC/DC switching pin
7	CE	Chip enable pin (active-high)
8	V _{IN}	Power input pin
9	V _{OUT1}	DC/DC converter output pin
10	V _{OUT2}	LDO output pin

Tab of the backside of the package is GND level. (They are connected to the reverse side of this IC.)
It should be connected to the GND pin (Recommendation case) or make it open.

• RP600K0xxB

Pin Number	Symbol	Descriptions
1	V _{SENSE}	SENSE pin (for Voltage Detector)
2	V _{DOUT}	Output pin of the voltage detector, Nch open drain output
3	CE2	Chip enable pin for voltage regulator (active-high)
4	MODE	MODE pin
5	GND	Ground pin
6	LX	DC/DC switching pin
7	CE1	Chip enable pin for DC/DC converter (active-high)
8	V _{IN}	Power input pin
9	V _{OUT1}	DC/DC converter output pin
10	V _{OUT2}	Voltage regulator output pin

Tab of the backside of the package is GND level. (They are connected to the reverse side of this IC.)
It should be connected to the GND pin (Recommendation case) or make it open.

• RP600K2xxC

Pin Number	Symbol	Descriptions
1	V _{SENSE}	SENSE pin (for Voltage Detector)
2	V _{DOUT}	Output pin of the voltage detector, Nch open drain output
3	TEST	TEST pin
4	MODE	Auto ECO pin ("H" fast mode, "L" Low power mode)
5	GND	Ground pin
6	LX	DC/DC switching pin
7	CE	Chip enable pin for DC/DC converter (active-high)
8	V _{IN}	Power input pin
9	V _{OUT1}	DC/DC converter output pin
10	V _{OUT2}	Voltage regulator output pin

Tab of the backside of the package is GND level. (They are connected to the reverse side of this IC.)
It should be connected to the GND pin (Recommendation case) or make it open.

LDO is always active.

TEST pin should be connected to the GND pin. If the TEST pin is open or "H", the voltage regulator may turn off.

• RP600K1xxD

Pin Number	Symbol	Descriptions
1	V _{SENSE}	SENSE pin (for Voltage Detector)
2	V _{DOUT}	Output pin of the voltage detector, Nch open drain output
3	V _{FB}	Feedback pin for setting DC/DC converter output voltage
4	MODE	MODE pin ("H" fast mode, "L" Low power mode)
5	GND	Ground pin
6	LX	DC/DC switching pin
7	CE	Chip enable pin for DC/DC converter (active-high)
8	V _{IN}	Power input pin
9	V _{OUT1}	DC/DC converter output pin
10	V _{OUT2}	Voltage regulator output pin

Tab of the backside of the package is GND level. (They are connected to the reverse side of this IC.)
It should be connected to the GND pin (Recommendation case) or make it open.

ABSOLUTE MAXIMAM RATINGS

Symbol	Items	Ratings	Unit	
V _{IN}	V _{IN} Supply Voltage	-0.3~6.0	V	
V _{OUT1}	V _{OUT1} Pin Voltage	-0.3~6.0	V	
V _{CE}	CE pin Voltage (other than B version)	-0.3~6.0	V	
V _{OUT2}	V _{OUT2} Pin Voltage	-0.3~V _{OUT1} +0.3	V	
V _{LX}	V _{LX} Pin Voltage	-0.3~6.0	V	
V _{DOUT}	V _{DOUT} Pin Voltage	-0.3~6.0	V	
V _{SENSE}	V _{SENSE} Pin Voltage	-0.3~6.0	V	
V _{CE1}	CE1 Pin Input Voltage (B version)	-0.3~6.0	V	
V _{CE2}	CE2 Pin Input Voltage (B version)	-0.3~6.0	V	
V _{MODE}	MODE Pin Input Voltage	-0.3~6.0	V	
V _{FB}	V _{FB} Pin Voltage (D version)	-0.3~V _{OUT1} +0.3	V	
P _D	Power Dissipation	Standard Land Pattern	910	mW
		High Wattage Land Pattern	1400	
T _a	Operating Temp Range	-40~+85	°C	
T _{stg}	Storage Temp Range	-55~+125	°C	

ABSOLUTE MAXIMUM RATINGS

Electronic and mechanical stress momentarily exceeded absolute maximum ratings may cause the permanent damages and may degrade the life time and safety for both device and system using the device in the field.

The functional operation at or over these absolute maximum ratings is not assured.

ELECTRICAL CHARACTERISTICS

RP600K0xxA

Unless otherwise specified, open loop measurement is applied to guarantee the specifications. (Ta=25°C)

Description	Symbol	Conditions	MIN.	TYP.	MAX.	Unit
Quiescent Current 1 (LDO operating DC/DC with heavy load PWM operation)	I _{SS1}	V _{IN} = V _{OUT1} = V _{CE} = V _{SET} × 0.95V		V _{OUT1} × 260+50	V _{OUT1} × 350+90	μA
Quiescent Current 2 (LDO operating DC/DC with light load VFM operation)	I _{SS2}	V _{IN} = V _{OUT1} = V _{CE} = 5.5V, V _{MODE} = 0V		170	260	μA
Standby Current	I _{standby}	V _{IN} = V _{OUT1} = 5.5V, V _{CE} = 0V		1.0	6.0	μA
CE "H" Input Current	I _{CEH}	V _{IN} = V _{OUT1} = V _{CE} = 5.5V			0.5	μA
CE "L" Input Current	I _{CEL}	V _{IN} = V _{OUT1} = 5.5V, V _{CE} = 0V	-0.5			μA
MODE "H" Input Current	I _{MODEH}	V _{IN} = V _{MODE} = 5.5V			0.5	μA
MODE "L" Input Current	I _{MODEL}	V _{IN} = 5.5V, V _{MODE} = 0V	-0.5			μA
CE input "H" level Voltage	V _{CEH}		0.7			V
CE input "L" level Voltage	V _{CEL}				0.3	V
MODE input "H" level Voltage	V _{MODEH}		1.1			V
MODE input "L" level Voltage	V _{MODEL}				0.4	V

DC/DC SECTION

Ta=25°C

Description	Symbol	Conditions	MIN.	TYP.	MAX.	Unit
Input Voltage	V _{IN}				5.5	V
Start-up Voltage	V _{START}	load current = 1mA, V _{CE} = V _{OUT1}			0.8	V
Hold-on Voltage (after start-up)	V _{HOLD}	load current = 1mA, V _{CE} = V _{OUT1}	0.7			V
Output Voltage1	V _{OUT1}		x0.98		x1.02	V
Output Voltage Range1	V _{OUT1}		2.3		5.5	V
Output Voltage1 Temperature Coefficient	ΔV _{OUT1} / ΔTa	-40°C ≤ Ta ≤ 85°C		±50		ppm/°C
Switching Frequency	f _{OSC}	V _{IN} = V _{OUT1} = V _{SET} × 0.7	1020	1200	1380	kHz
Switching Frequency Temperature Coefficient	Δf _{OSC} / ΔTa	-40°C ≤ Ta ≤ 85°C		±0.27		kHz/°C
Lx Switch ON Resistance *1	R _{ONN}	V _{OUT1} = 3.3V		0.16		Ω
Lx Leakage Current	I _{LX}	V _{IN} = V _{OUT1} = V _{LX} = 6.0V, V _{CE} = 0V			2.0	μA
Lx Current Limit	I _{LXPEAK}	V _{IN} = V _{SET} × 0.5	1.2	1.4		A
Maximum Duty Cycle	Maxdty	V _{IN} = V _{OUT1} = V _{SET} × 0.7	80	88	95	%
Soft start time 1	t _{START1}	V _{IN} = V _{SET} × 0.5, V _{CE} = 0V to 1.5V	0.08	0.70	3.00	ms

*1) This item is guaranteed by design, not mass production tested. Lx switch On resistance depends on the voltage of V_{OUT1}.

RP600K

VD SECTION

Ta=25°C

Description	Symbol	Conditions	MIN.	TYP.	MAX.	Unit
Input Voltage	V _{IN}		0.8		5.5	V
Voltage Detector Threshold	-V _{DET}	V _{IN} = 3.0V	x0.98 ^{*2}		x1.02 ^{*2}	V
Voltage Detector Threshold Range	-V _{DET}		1.0		4.5	V
Voltage Detector Threshold Temperature Coefficient	ΔV _{DET} /ΔTa	-40°C ≤ Ta ≤ 85°C		±100		ppm/°C
Detector Threshold Hysteresis	V _{HYS}	V _{IN} = 3.0V		-V _{DET} x0.05		
Sense Resistance	R _{SENSE}	V _{IN} = 6.0V, V _{SENSE} = 6.0V	0.2		20	MΩ
Voltage Detector Released Output Delay Time	t _{DELAY}	V _{IN} = 3.0V		10		ms
V _{DOUT} "L" Output Current	I _{DOUTL}	V _{IN} = 2.0V, V _{DOUT} = 0.1V, V _{SENSE} = 6.0V	0.1	0.3		mA
V _{DOUT} Leakage Current	I _{DOUTH}	V _{IN} = 6.0V, V _{DOUT} = 6.0V, V _{SENSE} = 6.0V			0.5	μA

*2) This item is guaranteed under the condition of V_{IN} range from 1.0V to 5.0V and guaranteed by design, not mass production tested.

LDO SECTION

Ta=25°C

Description	Symbol	Conditions	MIN.	TYP.	MAX.	Unit
Input Voltage	V _{IN}		2.0		5.5	V
Output Voltage 2 (Fast Mode)	V _{OUT2}	I _{OUT2} = 5mA, V _{OUT2} > 2.0V	x0.99		x1.01	V
		I _{OUT2} = 5mA, V _{OUT2} ≤ 2.0V	-20		20	mV
Output Voltage Range	V _{OUT2}		1.5		5.0	V
Output Voltage2 Temperature Coefficient	ΔV _{OUT2} /ΔTa	-40°C ≤ Ta ≤ 85°C		±100		ppm/°C
Output Current2	I _{OUT2}		500			mA
Load Regulation	ΔV _{OUT2} /ΔI _{OUT2}	10mA ≤ I _{OUT2} ≤ 500mA		50	100	mV
Dropout Voltage	V _{DIF}	Please refer to "Dropout Voltage".				
Line Regulation	ΔV _{OUT2} /ΔV _{IN}	V _{OUT2} +0.5V ≤ V _{IN} ≤ 5.5V *V _{OUT2} < 4.5V I _{OUT2} = 10mA (Fast Mode)	-0.1	±0.02	0.1	%/V
Ripple Rejection	RR	f=1kHz, Ripple 0.2Vp-p, V _{IN} = V _{OUT2} +1.0V, I _{OUT2} =30mA		70		dB
Short Current Limit	I _{LIM}	V _{OUT2} =0V		200		mA
Soft-start Time 2 ^{*3}	t _{START2}	after the DC/DC soft-start		200		μs

*3) This item is guaranteed by design, not mass production tested.

Thermal Shutdown Section

Description	Symbol	Conditions	MIN.	TYP.	MAX.	Unit
Input Voltage	V _{IN}		1.4		5.5	V
Thermal Shutdown temperature threshold	T _{TSD}	Junction Temperature		140		°C
Thermal Shutdown release temperature	T _{TSR}	Junction Temperature		95		°C

RP600K0xxB

Unless otherwise specified, open loop measurement is applied to guarantee the specifications. (Ta=25°C)

Description	Symbol	Conditions	MIN.	TYP.	MAX.	Unit
Quiescent Current 1 (LDO active, DCDC with heavy load PWM operation)	I _{SS1}	V _{IN} = V _{OUT1} = V _{SET} x 0.95V V _{CE1} = V _{CE2} = 5.5V		V _{OUT1} x 260+50	V _{OUT1} x 350+90	μA
Quiescent Current 2 (LDO active, DCDC with light load VFM operation)	I _{SS2}	V _{IN} = V _{OUT1} = 5.5V, V _{MODE} = 0V V _{CE1} = V _{CE2} = 5.5V		170	260	μA
Quiescent Current 3 (LDO off, DCDC with heavy load PWM operation)	I _{SS3}	V _{IN} = V _{OUT1} = V _{SET} x 0.95 V _{MODE} = 0V, V _{CE1} = 5.5V, V _{CE2} = 0V		V _{OUT1} x 260	V _{OUT1} x 350	μA
Quiescent Current 4 (LDO off, DCDC with light load VFM operation)	I _{SS4}	V _{IN} = V _{OUT1} = 5.5V, V _{MODE} = 0V V _{CE1} = 5.5V, V _{CE2} = 0V		120	170	μA
Quiescent Current 5 (LDO fast mode, DCDC off)	I _{SS5}	I _{OUT2} = 0mA, V _{MODE} = 5.5V V _{CE1} = 0V, V _{CE2} = 5.5V		50	90	μA
Quiescent Current 6 (LDO low power mode, DCDC off)	I _{SS6}	I _{OUT2} = 0mA, V _{MODE} = 0V V _{CE1} = 0V, V _{CE2} = 5.5V		6.0	15.0	μA
Standby Current	I _{standby}	V _{IN} = V _{OUT1} = 5.5V, V _{CE1} = V _{CE2} = 0V		1.0	6.0	μA
CE1 "H" Input Current	I _{CE1H}	V _{IN} = V _{OUT1} = V _{CE1} = 5.5V			0.5	μA
CE1 "L" Input Current	I _{CE1L}	V _{IN} = V _{OUT1} = 5.5V, V _{CE1} = 0V	-0.5			μA
CE2 "H" Input Current	I _{CE2H}	V _{IN} = V _{CE2} = 5.5V			0.5	μA
CE2 "L" Input Current	I _{CE2L}	V _{IN} = 5.5V, V _{CE2} = 0V	-0.5			μA
MODE "H" Input Current	I _{MODEH}	V _{IN} = V _{MODE} = 5.5V			0.5	μA
MODE "L" Input Current	I _{MODEL}	V _{IN} = 5.5V, V _{MODE} = 0V	-0.5			μA
CE1 input "H" level Voltage	V _{CE1H}		0.7			V
CE1 input "L" level Voltage	V _{CE1L}				0.3	V
CE2 input "H" level Voltage	V _{CE2H}		1.0			V
CE2 input "L" level Voltage	V _{CE2L}				0.4	V
MODE input "H" level Voltage	V _{MODEH}		1.1			V
MODE input "L" level Voltage	V _{MODEL}				0.4	V

RP600K

DC/DC SECTION

Ta=25°C

Description	Symbol	Conditions	MIN.	TYP.	MAX.	Unit
Input Voltage	V _{IN}				5.5	V
Start-up Voltage	V _{START}	I _{OUT1} = 1mA, V _{CE1} =V _{OUT1}			0.8	V
Hold-on Voltage(after start-up)	V _{HOLD}	I _{OUT1} = 1mA, V _{CE1} =V _{OUT1}	0.7			V
Output Voltage1	V _{OUT1}		x0.98		x1.02	V
Output Voltage Range1	V _{OUT1}		2.3		5.5	V
Output Voltage1 Temperature Coefficient	$\frac{\Delta V_{OUT1}}{\Delta Ta}$	-40°C ≤ Ta ≤ 85°C		±50		ppm/°C
Switching Frequency	f _{OSC}	V _{IN} =V _{OUT1} =V _{SET} ×0.7	1020	1200	1380	kHz
Switching Frequency Temperature Coefficient	$\frac{\Delta f_{OSC}}{\Delta Ta}$	-40°C ≤ Ta ≤ 85°C		±0.27		kHz/°C
Lx Switch ON Resistance *1	R _{ONN}	V _{OUT1} =3.3V		0.16		Ω
Lx Leakage Current	I _{LX}	V _{IN} = V _{OUT1} = V _{LX} = 6.0V, V _{CE1} = 0V			2.0	μA
Lx Current Limit	I _{LXPEAK}	V _{IN} = V _{SET} × 0.5	1.2	1.4		A
Maximum Duty Cycle	Maxdty	V _{IN} = V _{OUT1} = V _{SET} × 0.7	80	88	95	%
Soft start time 1	t _{START1}	V _{IN} = V _{SET} × 0.5, V _{CE} = 0V to 1.5V	0.08	0.70	3.00	ms

*1) This item is guaranteed by design, not mass production tested. Lx switch On resistance depends on the voltage of V_{OUT1}.

VD SECTION

Ta=25°C

Description	Symbol	Conditions	MIN.	TYP.	MAX.	Unit
Input Voltage	V _{IN}		0.8		5.5	V
Voltage Detector Threshold	-V _{DET}	V _{IN} = 3.0V	x0.98 ^{*2}		x1.02 ^{*2}	V
Detector Threshold Range	-V _{DET}		1.0		4.5	V
Voltage Detector Threshold Temperature Coefficient	$\frac{\Delta V_{DET}}{\Delta Ta}$	-40°C ≤ Ta ≤ 85°C		±100		ppm/°C
Detector Threshold Hysteresis	V _{HYS}	V _{IN} = 3.0V		-V _{DET} × 0.05		
Sense Resistance	R _{SENSE}	V _{IN} = 6.0V, V _{SENSE} = 6.0V	0.2		20	MΩ
Voltage Detector Released Output Delay Time	t _{DELAY}	V _{IN} = 3.0V		10		ms
V _{DOUT} "L" Output Current	I _{DOUTL}	V _{IN} = 2.0V, V _{DOUT} = 0.1V, V _{SENSE} = 0V	0.1	0.3		mA
V _{DOUT} Leakage Current	I _{DOUTH}	V _{IN} = 6.0V, V _{DOUT} = 6.0V, V _{SENSE} = 6.0V			0.5	μA

*2) This item is guaranteed under the condition of V_{IN} range from 1.0V to 5.0V and guaranteed by design, not mass production tested.

LDO SECTION

Ta=25°C

Description	Symbol	Conditions	MIN.	TYP.	MAX.	Unit	
Input Voltage	V _{IN}		2.0		5.5	V	
Output Voltage 2 (Fast Mode)	V _{OUT2}	I _{OUT2} =5mA	V _{OUT2} >2.0V	x0.99	x1.01	%	
			V _{OUT2} ≤2.0V	-20	20	mV	
Output Voltage Range	V _{OUT2}		1.5		5.0	V	
Output Voltage2 Temperature Coefficient	$\frac{\Delta V_{OUT2}}{\Delta T_a}$	-40°C≤Ta≤85°C		±100		ppm/°C	
Output Current2	I _{OUT2}		300			mA	
Fast Mode Switch-over Current	I _{OUTH}	I _{OUT2} =Light load to Heavy Load		3.2	5.0	mA	
Low Power Mode Switch-over Current	I _{OUTL}	I _{OUT2} =Heavy load to Light Load	0.7	1.5		mA	
Load Regulation	$\frac{\Delta V_{OUT2}}{\Delta I_{OUT2}}$	0.5mA≤ I _{OUT2} ≤10mA V _{CE1} =V _{MODE} =0V	V _{OUT2} >2.0V	-1.2	1.2	%	
			V _{OUT2} ≤2.0V	-24	24	mV	
		10mA≤ I _{OUT2} ≤300mA		30	60	mV	
Dropout Voltage	V _{DIF}	Please refer to “Dropout Voltage”.					
Line Regulation	$\frac{\Delta V_{OUT2}}{\Delta V_{IN}}$	V _{OUT2} +0.5V≤ V _{IN} ≤5.5V, V _{MODE} =0V *V _{OUT2} ≤4.5V	I _{OUT2} =0.5mA (Low Power Mode)	-0.2		0.2	%V
			I _{OUT2} =10mA (Fast Mode)	-0.1	±0.02	0.1	
Ripple Rejection	RR	f=1kHz, Ripple 0.2Vp-p, V _{IN} = V _{OUT2} +1.0V, I _{OUT2} =30mA		70		dB	
Short Current Limit	I _{LIM}	V _{OUT2} =0V		150		mA	
Soft-start Time 2 ^{*3}	t _{START2}	after the DC/DC soft-start		200		μs	

*3) This item is guaranteed by design, not mass production tested.

Thermal Shutdown Section

Description	Symbol	Conditions	MIN.	TYP.	MAX.	Unit
Input Voltage	V _{IN}		1.4		5.5	V
Thermal Shutdown temperature threshold	T _{TSD}	Junction Temperature		140		°C
Thermal Shutdown release temperature	T _{TSR}	Junction Temperature		95		°C

RP600K

RP600K2xxC

Unless otherwise specified, open loop measurement is applied to guarantee the specifications. (Ta=25°C)

Description	Symbol	Conditions	MIN.	TYP.	MAX.	Unit
Quiescent Current 1 (LDO on, DC/DC with heavy load PWM operation)	I _{SS1}	V _{IN} = V _{OUT1} =V _{CE} =V _{SET} x 0.95V		V _{OUT1} x 260+50	V _{OUT1} x 350+90	μA
Quiescent Current 2 (LDO on, DC/DC with light load VFM operation)	I _{SS2}	V _{IN} =V _{OUT1} =5.5V, V _{CE} =V _{MODE} =0V,		170	260	μA
Quiescent Current 3 (LDO with low power mode)	I _{SS3}	V _{IN} = V _{OUT1} =5.5V, V _{CE} =V _{MODE} =0V, I _{OUT2} =0mA		2.0	7.0	μA
Quiescent Current 4 (LDO with fast mode)	I _{SS4}	V _{IN} =V _{OUT1} =V _{MODE} =5.5V, V _{CE} =0V		50	90	μA
CE "H" Input Current	I _{CEH}	V _{IN} = V _{OUT1} = V _{CE} =5.5V			0.5	μA
CE "L" Input Current	I _{CEL}	V _{IN} = V _{OUT1} =5.5V, V _{CE} =0V	-0.5			μA
MODE "H" Input Current	I _{MODEH}	V _{IN} = V _{MODE} =5.5V			0.5	μA
MODE "L" Input Current	I _{MODEL}	V _{IN} =5.5V, V _{MODE} =0V	-0.5			μA
CE input "H" level Voltage	V _{CEH}		0.7			V
CE input "L" level Voltage	V _{CEL}				0.3	V
MODE input "H" level Voltage	V _{MODEH}		1.1			V
MODE input "L" level Voltage	V _{MODEL}				0.4	V

DC/DC SECTION

Ta=25°C

Description	Symbol	Conditions	MIN.	TYP.	MAX.	Unit
Input Voltage	V _{IN}				5.5	V
Start-up Voltage	V _{START}	I _{OUT} = 1mA, V _{CE} =V _{OUT1}			0.8	V
Hold-on Voltage (After start-up)	V _{HOLD}	I _{OUT} = 1mA, V _{CE} =V _{OUT1}	0.7			V
Output Voltage1	V _{OUT1}		x0.98		x1.02	V
Output Voltage Range1	V _{OUT1}		2.3		5.5	V
Output Voltage1 Temperature Coefficient	$\frac{\Delta V_{OUT1}}{\Delta T_a}$	-40°C ≤ Ta ≤ 85°C		±50		ppm/°C
Switching Frequency	f _{OSC}	V _{IN} =V _{OUT1} =V _{SET} x0.95	1020	1200	1380	kHz
Switching Frequency Temperature Coefficient	$\frac{\Delta f_{OSC}}{\Delta T_a}$	-40°C ≤ Ta ≤ 85°C		±0.27		kHz/°C
Lx Switch ON Resistance *1	R _{ONN}	V _{OUT1} =3.3V		0.16		Ω
Lx Leakage Current	I _{LX}	V _{IN} =V _{OUT1} =V _{LX} =6.0V, V _{CE} =0V			2.0	μA
Lx Current Limit	I _{LXPEAK}	V _{IN} =V _{SET} x0.5	1.2	1.4		A
Maximum Duty Cycle	Maxdty	V _{IN} =V _{OUT1} =V _{SET} x0.7	80	88	95	%
Soft start time 1	t _{START1}	V _{IN} =V _{SET} x0.5, V _{CE} =0V to 1.5V	0.08	0.7	3.0	ms

*1) This item is guaranteed by design, not mass production tested. Lx switch On resistance depends on the voltage of V_{OUT1}.

VD SECTION

Ta=25°C

Description	Symbol	Conditions	MIN.	TYP.	MAX.	Unit
Input Voltage	V _{IN}		0.8		5.5	V
Voltage Detector Threshold	-V _{DET}	V _{IN} =3.0V	x0.98 ²		x1.02 ²	V
Voltage Detector Threshold Range	-V _{DET}		1.0		4.5	V
Voltage Detector Threshold Temperature Coefficient	ΔV _{DET} /ΔTa	-40°C≤Ta≤85°C		±100		ppm/°C
Detector Threshold Hysteresis	V _{HYS}	V _{IN} =3.0V		-V _{DET} x0.3 to -V _{DET} x0.8		
Sense Resistance	R _{SENSE}	V _{IN} =6.0V, V _{SENSE} =6.0V	0.2		20.0	MΩ
Voltage Detector Released Output Delay Time	t _{DELAY}	V _{IN} =3.0V		0	200	μs
V _{DOUT} "L" Output Current	I _{DOUTL}	V _{IN} =2.0V, V _{DOUT} =0.1V, V _{SENSE} =6.0V	0.1	0.3		mA
V _{DOUT} Leakage Current	I _{DOUTH}	V _{IN} =6.0V, V _{DOUT} =6.0V, V _{SENSE} =0V			0.5	μA

*2) This item is guaranteed under the condition of V_{IN} range from 1.0V to 5.0V and guaranteed by design, not mass production tested.

LDO SECTION

Ta=25°C

Description	Symbol	Conditions	MIN.	TYP.	MAX.	Unit
Input Voltage	V _{IN}		2.0		5.5	V
Output Voltage 2 (Fast Mode)	V _{OUT2}	I _{OUT2} =5mA, V _{OUT2} >2.0V	x0.99		x1.01	%
		V _{OUT2} ≤2.0V	-20		20	mV
Output Voltage Range	V _{OUT2}		1.5		5.0	V
Output Voltage2 Temperature Coefficient	ΔV _{OUT2} /ΔTa	-40°C≤Ta≤85°C		±100		ppm/°C
Output Current2	I _{OUT2}		150			mA
Fast Mode Switch-over Current	I _{OUTH}	I _{OUT2} =Light load to Heavy Load		3.2	5.0	mA
Low Power Mode Switch-over Current	I _{OUTL}	I _{OUT2} =Heavy load to Light Load	0.7	1.5		mA
Load Regulation	ΔV _{OUT2} /ΔI _{OUT2}	0.5mA≤ I _{OUT2} ≤10mA, V _{OUT2} >2.0V	-1.2		1.2	%
		V _{OUT2} ≤2.0V	-24		24	mV
		10mA≤ I _{OUT2} ≤150mA		15	40	mV
Dropout Voltage	V _{DIF}	Please refer to "Dropout Voltage".				
Line Regulation	ΔV _{OUT2} /ΔV _{IN}	V _{OUT2} +0.5V≤ V _{IN} ≤5.5V, I _{OUT2} =0.5mA (Low Power Mode)	-0.2		0.2	%V
		*V _{OUT2} <4.5V, I _{OUT2} =10mA (Fast Mode)	-0.1	±0.02	0.1	
Ripple Rejection	RR	f=1kHz, Ripple 0.2Vp-p, V _{IN} = V _{OUT2} +1.0V, I _{OUT2} =30mA		70		dB
Short Current Limit	I _{LIM}	V _{OUT2} =0V		60		mA
Soft-start Time 2 ³	t _{START2}			200		μs

*3) This item is guaranteed by design, not mass production tested.

RP600K

RP600K1xxD

Unless otherwise specified, open loop measurement is applied to guarantee the specifications. (Ta=25°C)

Description	Symbol	Conditions	MIN.	TYP.	MAX.	Unit
Quiescent Current 1 (LDO operating DC/DC with heavy load PWM operation)	I _{SS1}	V _{IN} =2.0V, V _{OUT1} =V _{CE} =2.5V, V _{FB} =0V		700	950	μA
Quiescent Current 2 (LDO operating DC/DC with light load VFM operation)	I _{SS2}	V _{IN} =V _{OUT1} =V _{CE} =5.5V, V _{MODE} =0V, V _{FB} =1.0V		170	260	μA
Standby Current	I _{standby}	V _{IN} =V _{OUT1} =5.5V, V _{CE} =0V		1.0	6.0	μA
CE "H" Input Current	I _{CEH}	V _{IN} =V _{OUT1} =V _{CE} =5.5V			0.5	μA
CE "L" Input Current	I _{CEL}	V _{IN} =V _{OUT1} =5.5V, V _{CE} =0V	-0.5			μA
MODE "H" Input Current	I _{MODEH}	V _{IN} =V _{MODE} =5.5V			0.5	μA
MODE "L" Input Current	I _{MODEL}	V _{IN} =5.5V, V _{MODE} =0V	-0.5			μA
CE input "H" level Voltage	V _{CEH}		0.7			V
CE input "L" level Voltage	V _{CEL}				0.3	V
MODE input "H" level Voltage	V _{MODEH}		1.1			V
MODE input "L" level Voltage	V _{MODEL}				0.4	V

DC/DC SECTION

Ta=25°C

Description	Symbol	Conditions	MIN.	TYP.	MAX.	Unit
Input Voltage	V _{IN}				5.5	V
Start-up Voltage	V _{START}	I _{OUT1} = 1mA, V _{CE1} =V _{OUT1}			0.8	V
Hold-on Voltage (after start-up)	V _{HOLD}	I _{OUT1} = 1mA, V _{CE1} =V _{OUT1}	0.7			V
Feedback Voltage	V _{FB}		0.588	0.600	0.612	V
Output Voltage Range1	V _{OUT1}		2.3		5.5	V
Output Voltage1 Temperature Coefficient	ΔV _{OUT1} /ΔTa	-40°C≤Ta≤85°C		±50		ppm/°C
Switching Frequency	f _{OSC}	V _{IN} =V _{OUT1} =V _{SET} ×0.7	1020	1200	1380	kHz
Switching Frequency Temperature Coefficient	Δf _{OSC} /ΔTa	-40°C≤Ta≤85°C		±0.27		kHz/°C
Lx Switch ON Resistance *1	R _{ONN}	V _{OUT1} =3.3V		0.16		Ω
FB Input Current "H"	I _{FBH}	V _{IN} =V _{OUT1} =V _{FB} =5.5V, V _{CE} =0V			0.5	μA
FB Input Current "L"	I _{FBL}	V _{IN} =V _{OUT1} =5.5V, V _{FB} =V _{CE} =0V	-0.5			μA
Lx Leakage Current	I _{LX}	V _{IN} =V _{OUT1} =V _{LX} =6.0V, V _{CE1} =0V			2.0	μA
Lx Current Limit	I _{LXPEAK}	V _{IN} =V _{SET} ×0.5	1.2	1.4		A
Maximum Duty Cycle	Maxdty	V _{IN} =V _{OUT1} =V _{SET} ×0.7	80	88	95	%
Soft start time 1	t _{START1}	V _{IN} =V _{SET} ×0.5, V _{CE} =0V to 1.5V	0.08	0.70	3.00	ms

*1) This item is guaranteed by design, not mass production tested. Lx switch On resistance depends on the voltage of V_{OUT1}.

VD SECTION

Ta=25°C

Description	Symbol	Conditions	MIN.	TYP.	MAX.	Unit
Input Voltage	V _{IN}		0.8		5.5	V
Voltage Detector Threshold	-V _{DET}	V _{IN} =3.0V	x0.98 ²		x1.02 ²	V
Detector Threshold Range	-V _{DET}		1.0		4.5	V
Voltage Detector Threshold Temperature Coefficient	ΔV _{DET} /ΔTa	-40°C≤Ta≤85°C		±100		ppm/°C
Detector Threshold Hysteresis	V _{HYS}	V _{IN} =3.0V		-V _{DET} x0.05		
Sense Resistance	R _{SENSE}	V _{IN} =6.0V, V _{SENSE} =6.0V	0.2		20.0	MΩ
Voltage Detector Released Output Delay Time	t _{DELAY}	V _{IN} =3.0V		10		ms
V _{DOUT} "L" Output Current	I _{DOUTL}	V _{IN} =2.0V, V _{DOUT} =0.1V, V _{SENSE} =0V	0.1	0.3		mA
V _{DOUT} Leakage Current	I _{DOUTH}	V _{IN} =6.0V, V _{DOUT} =6.0V, V _{SENSE} =6.0V			0.5	μA

*2) This item is guaranteed under the condition of V_{IN} range from 1.0V to 5.0V and guaranteed by design, not mass production tested.

LDO SECTION

Ta=25°C

Description	Symbol	Conditions	MIN.	TYP.	MAX.	Unit
Input Voltage	V _{IN}		2.0		5.5	V
Output Voltage 2 (Fast Mode)	V _{OUT2}	I _{OUT2} =5mA, V _{OUT2} >2.0V	x0.99		x1.01	V
		I _{OUT2} =5mA, V _{OUT2} ≤2.0V	-20		20	mV
Output Voltage Range	V _{OUT2}		1.5		5.0	V
Output Voltage2 Temperature Coefficient	ΔV _{OUT2} /ΔTa	-40°C≤Ta≤85°C		±100		ppm/°C
Output Current2	I _{OUT2}		500			mA
Load Regulation	ΔV _{OUT2} /ΔI _{OUT2}	10mA≤ I _{OUT2} ≤500mA		50	100	mV
Dropout Voltage	V _{DIF}	Please refer to "Dropout Voltage".				
Line Regulation	ΔV _{OUT2} /ΔV _{IN}	V _{OUT2} +0.5V≤V _{IN} ≤5.5V *V _{OUT2} ≤4.5V I _{OUT2} =10mA (Fast Mode)	-0.1	±0.02	0.1	%/V
Ripple Rejection	RR	f=1kHz, Ripple 0.2Vp-p, V _{IN} = V _{OUT2} +1.0V, I _{OUT2} =30mA		70		dB
Short Current Limit	I _{LIM}	V _{OUT2} =0V		200		mA
Soft-start Time 2 ^{*3}	t _{START2}	after the DC/DC soft-start		200		μs

*3) Refer to the Timing Chart. This item is guaranteed by design, not mass production tested.

Thermal Shutdown Section

Description	Symbol	Conditions	MIN.	TYP.	MAX.	Unit
Input Voltage	V _{IN}		1.4		5.5	V
Thermal Shutdown temperature threshold	T _{TSD}	Junction Temperature		140		°C
Thermal Shutdown release temperature	T _{TSR}	Junction Temperature		95		°C

●LDO Dropout Voltage

•A&D_Ver.

Output Voltage V_{OUT2} (V)	Dropout Voltage V_{DIF} (V)		
	Condition	Typ.	Max.
$1.5 \leq V_{OUT2} < 1.8$	$I_{OUT2}=500mA$	0.45	0.60
$1.8 \leq V_{OUT2} < 2.1$		0.40	0.53
$2.1 \leq V_{OUT2} < 3.3$		0.36	0.48
$3.3 \leq V_{OUT2} \leq 5.0$		0.28	0.38

•B_Ver.

Output Voltage V_{OUT2} (V)	Dropout Voltage V_{DIF} (V)		
	Condition	Typ.	Max.
$1.5 \leq V_{OUT2} < 1.8$	$I_{OUT2}=300mA$	0.26	0.37
$1.8 \leq V_{OUT2} < 2.1$		0.24	0.32
$2.1 \leq V_{OUT2} < 3.3$		0.22	0.29
$3.3 \leq V_{OUT2} \leq 5.0$		0.17	0.20

•C_Ver.

Output Voltage V_{OUT2} (V)	Dropout Voltage V_{DIF} (V)		
	Condition	Typ.	Max.
$1.5 \leq V_{OUT2} < 1.8$	$I_{OUT2}=150mA$	0.14	0.19
$1.8 \leq V_{OUT2} < 2.1$		0.12	0.16
$2.1 \leq V_{OUT2} < 3.3$		0.11	0.15
$3.3 \leq V_{OUT2} \leq 5.0$		0.09	0.11

TYPICAL APPLICATION

A_Version

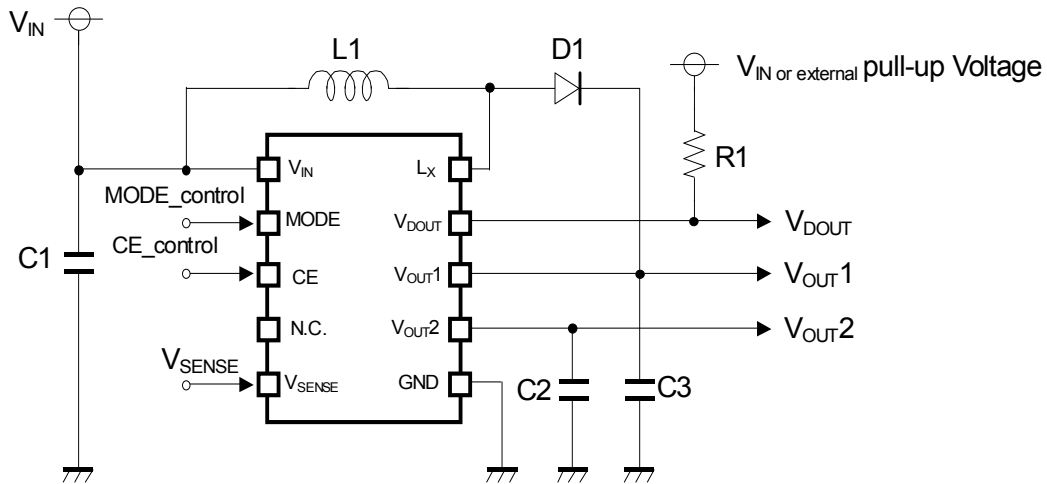

B_Version

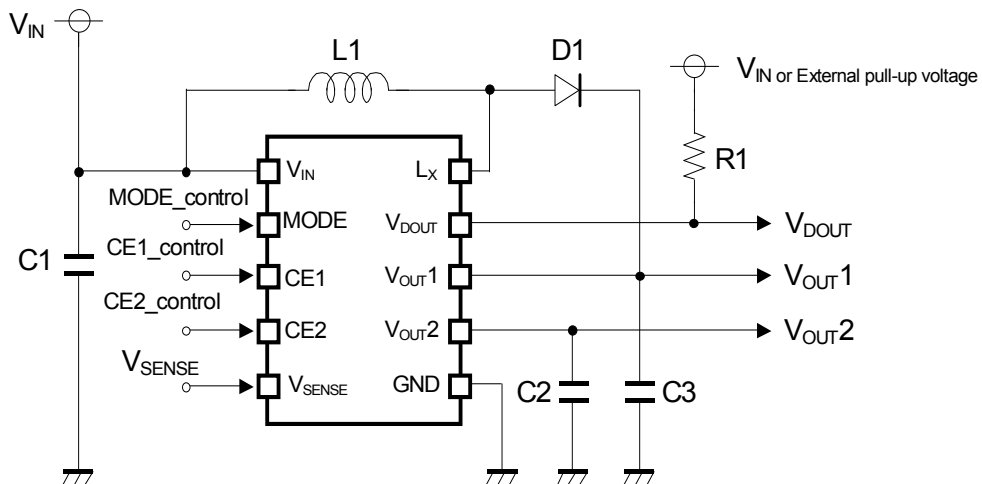

C_Version

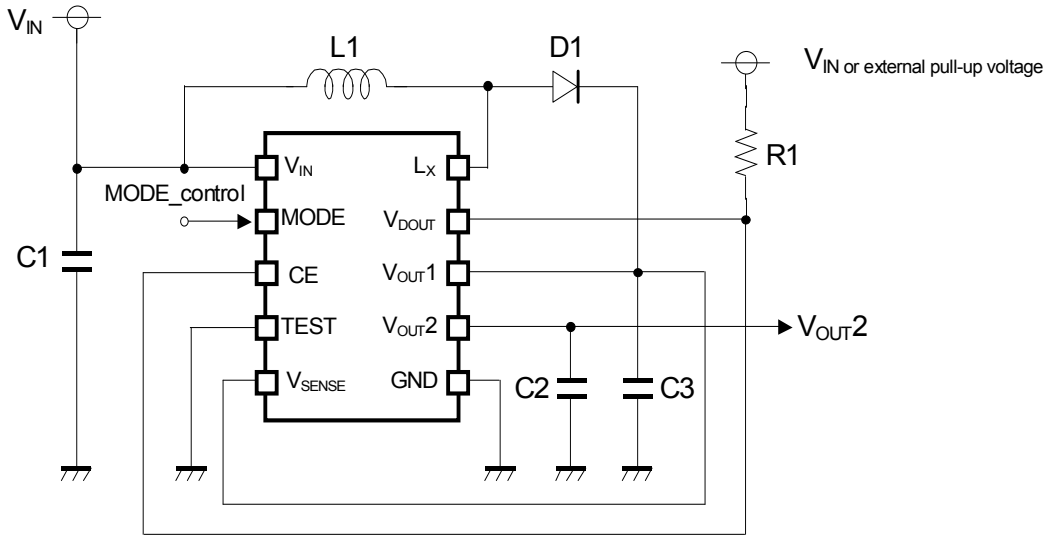

D_Version

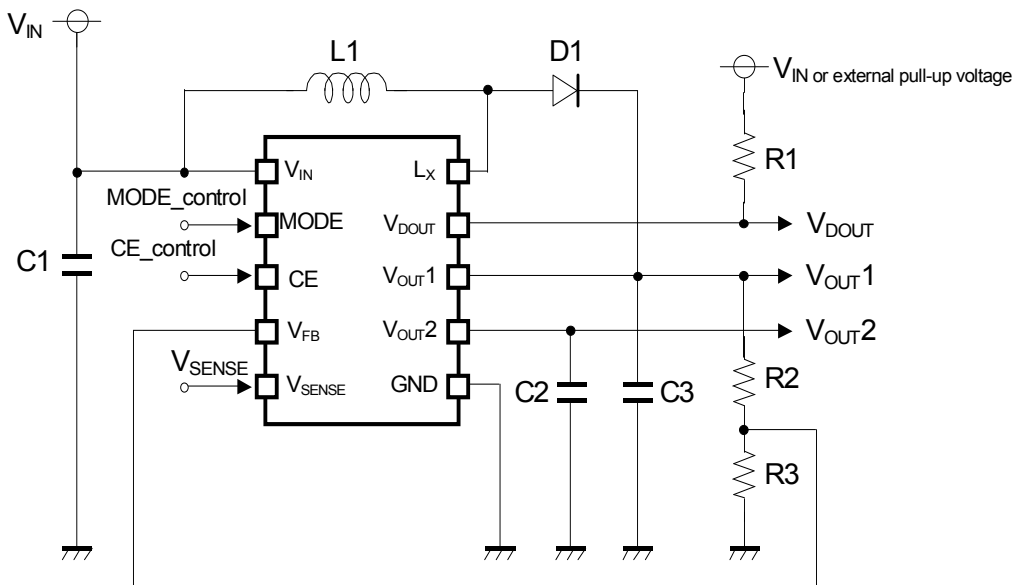

■ External Components Recommendation

- Inductor L1 $V_{OUT1} < 3.6V$, SLF7028T-3R3M1R6-PF, (3.3 μ H, TDK)
 $V_{OUT1} \geq 3.6V$, SLF7028T-4R7M1R5-PF, (4.7 μ H, TDK)

- Diode D1

[A/B/D_Version]

$I_{LXPEAK} < 1.0A$, CRS10I30A, (TOSHIBA)

$I_{LXPEAK} \geq 1.0A$, CMS06, (TOSHIBA)

[C_Version]

RB550VA-30, (ROHM)

- Capacitor C1 C1608JB0J106M, (10 μ F, TDK)
- Capacitor C2 C1608JB0J106M, (10 μ F, TDK)
- Capacitor C3 C1608JB0J106M x 2, (10 μ F x 2, TDK)

- Pull-up Resistance R1 100k Ω

- ◆ Capacitor C2 Small Components example

* If the small capacitors such as shown below are selected, the operation of the RP600 is stable, however, to reduce the output ripple, C1608JB0J106M (10 μ F, TDK) is better than items below.

[B/C_Version]

$V_{OUT2} \leq 3.3V$, C1005JB0J225M, (2.2 μ F, TDK)

$V_{OUT2} > 3.3V$, C1608JB0J225M, (2.2 μ F, TDK)

[A/D_Version]

$V_{OUT2} \leq 3.3V$, C1005JB0J475M x 2, (4.7 μ F, TDK)

$V_{OUT2} > 3.3V$, C1608JB0J475M, (4.7 μ F, TDK)

OUTPUT CURRENT OF STEP-UP CIRCUIT

<Basic Circuit>

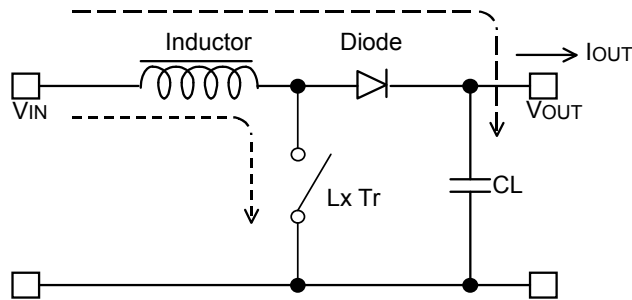

<Current through L>

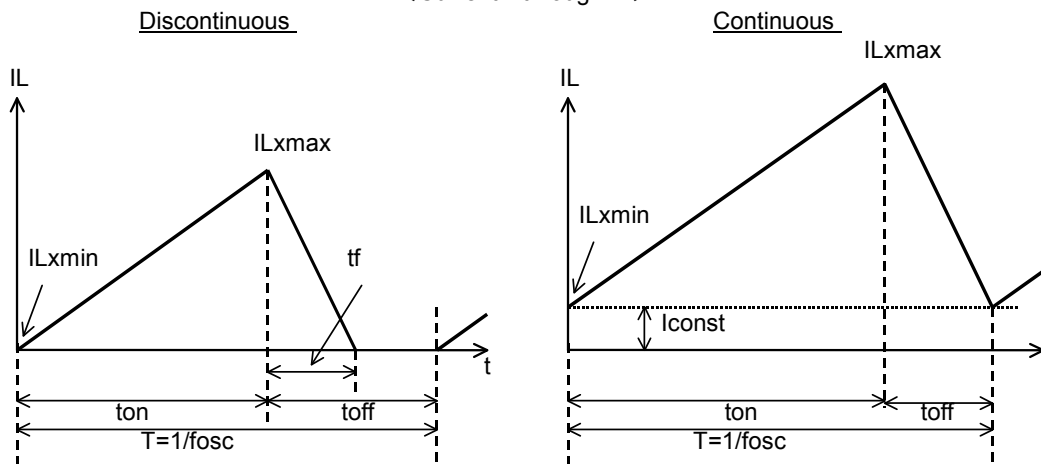

There are two modes, or discontinuous mode and continuous mode for the PWM step-up switching regulator depending on the continuous characteristic of inductor current. During on time of the transistor, when the voltage added on to the inductor is described as V_{IN} , the current is $V_{IN} \times t / L$. Therefore, the electric power, P_{ON} , which is supplied with input side, can be described as in next formula.

$$P_{ON} = \int_0^{ton} V_{IN}^2 \times t / L \, dt \dots\dots\dots \text{Formula 1}$$

With the step-up circuit, electric power is supplied from power source also during off time. In this case, input current is described as $(V_{OUT} - V_{IN}) \times t / L$, therefore electric power, P_{OFF} is described as in next formula.

$$P_{OFF} = \int_0^{toff} V_{IN} \times (V_{OUT} - V_{IN}) t / L \, dt \dots\dots\dots \text{Formula 2}$$

In this formula, t_f means the time of which the energy saved in the inductance is being emitted. Thus average electric power, P_{AV} is described as in the next formula.

$$P_{AV} = 1 / (ton + toff) \times \left\{ \int_0^{ton} V_{IN}^2 \times t / L \, dt + \int_0^{toff} V_{IN} \times (V_{OUT} - V_{IN}) t / L \, dt \right\} \dots\dots\dots \text{Formula 3}$$

In PWM control, when $t_f = t_{off}$ is true, the inductor current becomes continuous, then the operation of switching regulator becomes continuous mode. In the continuous mode, the deviation of the current is equal between on time and off time.

$$V_{IN} \times t_{on} / L = (V_{OUT} - V_{IN}) \times t_{off} / L \dots \dots \dots \text{Formula 4}$$

Further, the electric power, PAV is equal to output electric power, $V_{OUT} \times I_{OUT}$, thus,

$$I_{OUT} = f_{osc} \times V_{IN}^2 \times t_{on}^2 / \{2 \times L (V_{OUT} - V_{IN})\} = V_{IN}^2 \times t_{on} / (2 \times L \times V_{OUT}) \dots \dots \dots \text{Formula 5}$$

When I_{OUT} becomes more than $V_{IN} \times t_{on} \times t_{off} / (2 \times L \times (t_{on} + t_{off}))$, the current flows through the inductor, then the mode becomes continuous. The continuous current through the inductor is described as I_{const} , then,

$$I_{OUT} = f_{osc} \times V_{IN}^2 \times t_{on}^2 / (2 \times L \times (V_{OUT} - V_{IN})) + V_{IN} \times I_{const} / V_{OUT} \dots \dots \dots \text{Formula 6}$$

In this moment, the peak current, I_{Lxmax} flowing through the inductor and the driver Tr. is described as follows:

$$I_{Lxmax} = I_{const} + V_{IN} \times t_{on} / L \dots \dots \dots \text{Formula 7}$$

With the formula 4, 6 and I_{Lxmax} is

$$I_{Lxmax} = V_{OUT} / V_{IN} \times I_{OUT} + V_{IN} \times t_{on} / (2 \times L) \dots \dots \dots \text{Formula 8}$$

However, $t_{on} = (1 - V_{IN} / V_{OUT}) / f_{osc}$

Therefore, peak current is more than I_{OUT} . Considering the value of I_{Lxmax} , the condition of input and output, and external components should be selected.

In the formula 7, peak current I_{Lxmax} at discontinuous mode can be calculated. Put $I_{const} = 0$ in the formula.

The explanation above is based on the ideal calculation, and the loss caused by L_x switch and external components is not included. Please select the inductor and the diode with current peak to the standard (Formula 8).

EXTERNAL COMPONENTS and TECHNICAL NOTES

*Make enforce both V_{IN} and GND lines sufficient. Large current by switching may flow through the V_{IN} line and GND line. If their impedance is high, the internal voltage of the IC may shift by the switching current and the operation may unstable. When the built-in L_x switch turns off, a spike noise may be generated caused by the inductor, therefore recommendation range of the voltage rating of capacitor C3 and the shottky barrier diode is 1.5 or more times as much as the set output voltage.

*Select a diode with low V_f (Shottky barrier diode), low reverse current, fast switching speed.

*In this IC, after the step-up, V_{OUT1} voltage is used as a main power source of the IC. That means the capacitor C3 between V_{OUT1} and GND has a role of the bypass capacitor of the IC. Therefore, to select the capacitor C3 between V_{OUT1} and GND, consider the bias characteristics, and mean value must be $10\mu F$ or more. Set the capacitor as close as possible to the V_{OUT1} pin and GND pin. A capacitor C1 between V_{IN} and GND, select $10\mu F$ or more capacitance ceramic type.

*As for the capacitor C2 between V_{OUT2} and GND, consider the bias characteristics, put the $2.2\mu F$ or more ceramic capacitor as close as possible to the V_{OUT2} pin and GND pin.

-In case of A, C, and D version, V_{OUT2} operates with V_{OUT1} voltage as power supply. Therefore, the capacitor C3 between V_{OUT1} and GND has a role of the bypass capacitor of the V_{OUT2} . If the position of C2, C3 and GND are not close one another, put a $0.001\mu F$ capacitor between V_{OUT1} and the GND of C2.

*Select the inductance value according to the set output voltage. If $V_{OUT1} \geq 3.6V$ is true, $4.7\mu H$ is the recommendation value, and if $V_{OUT1} < 3.6V$ is true, $3.3\mu H$ is the recommendation value. Low DCR, enough permissible current, and uneasy to become magnetic saturation characteristics are preferable. If the inductance value is too small, the current of Lx transistor and inductor current or Lx peak current at maximum load may exceed the absolute maximum rating. Choose an appropriate value.

*If the spike noise of the Lx pin is large, put the snub circuit (serial CR connection) in parallel with the diode D1 and reduce the spike noise. The time constant of CR depends on the actual PCB, and efficiency may be effected, therefore fully evaluation on the actual PCB is necessary. (As much as 10Ω and $300pF$ is the nominal value.)

*The performance with this IC largely depends on the peripheral circuits. Do not exceed the ratings of voltage, current, and power for each external component and IC and consider the PCB layout.

DC/DC output voltage setting method (for D version)

DC/DC output voltage (V_{OUT1}) is determined by the divider resistors, R2 and R3.

$$V_{OUT1} = V_{FB} \times (R2 + R3) / R3 \quad (V_{FB} = 0.6V)$$

The recommendation range of R2+R3 is equal or less than $100k\Omega$.

GENERAL TECHNICAL NOTES

(Common for all versions:)

*If the built-in detector is not used, set the V_{DOUT} pin and V_{SENSE} pin to the GND.

*If the output of the DC/DC (V_{OUT1}) is under the condition of the output short ($V_{OUT1} < 0.5V$), to protect the IC itself, the switching will stop. However, an external path remains between V_{in} and GND and large current flows.

*When the LDO start-up, inrush current suppression function operates and until the output voltage reaches to the set output voltage, the maximum current is limited around the short current limit. Start-up load current must be low.

(A, C, and D version)

The output of the DC/DC (V_{OUT1}) is input voltage for LDO (V_{OUT2}), therefore $V_{OUT1} - V_{OUT2}$ is dropout voltage for LDO, therefore, the decide the voltage of V_{OUT1} with considering the load current of V_{OUT2} and output characteristics of V_{OUT1} and V_{OUT2} .

If the DC/DC converter must limit the current, to protect the IC, LDO turns off. When the DC/DC starts up, if a heavy load is forced, or the capacitor, C3 between V_{OUT1} and GND is large, current limit may operate and start-up of the LDO may be slow. Especially, the step-up ratio is high, this phenomenon is likely to happen, and fully evaluation is necessary.

When the LDO starts-up, inrush current limit operates, and DC/DC converter can avoid the heavy load, however, if the DC/DC converter's load current is large, LDO may turn off.

TIMING CHART (A/D version)
Soft-start operation, DC/DC short circuit limit

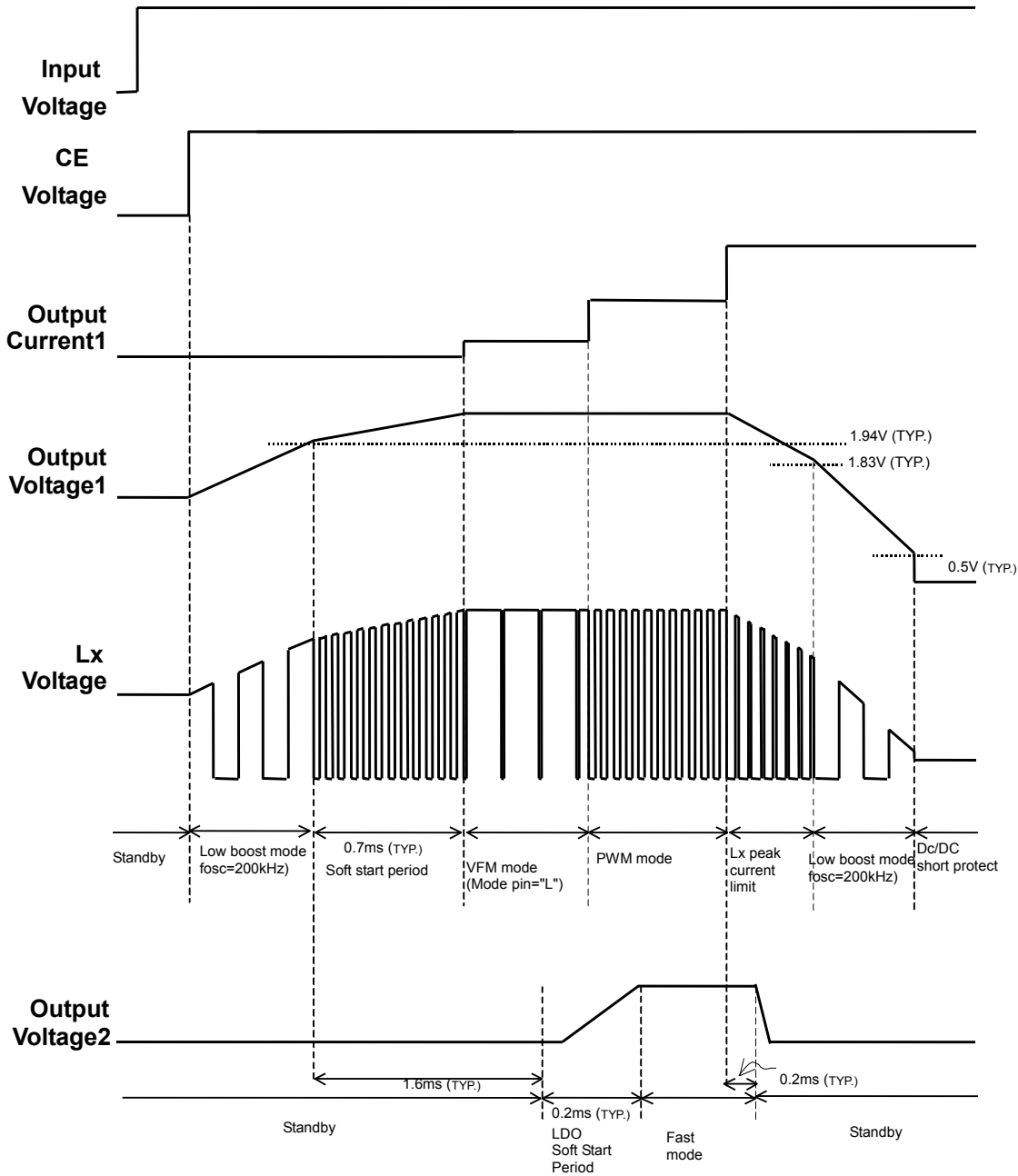

(1) DC/DC Converter

(Start-up) When the CE signal changes from "L" to "H", the DC/DC converter starts up.

The DC/DC converter of the RP600 can start up with the low input voltage such as 0.8V. To realize this, the RP600 has a low-boost mode. Until the output voltage 1 reaches 1.94V (Typ.), the operation mode is low-boost mode. When the output voltage becomes equal or more than 1.94V, then to suppress the inrush current, soft-start operation starts until the output voltage 1 becomes set output voltage.

*At the low-boost mode, the oscillator frequency becomes low, 200kHz (Typ.) Therefore, compared with the normal operation mode at 1.2MHz, the boost ability will worse.

Soft-start time depends on the set output voltage, the input voltage, the ambient temperature, and the load current.

Soft start period vs. Input Voltage

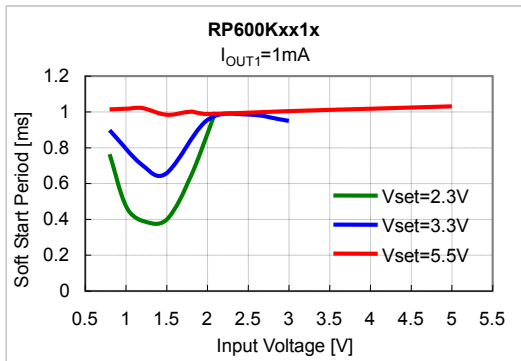

Soft start period vs. Temperature

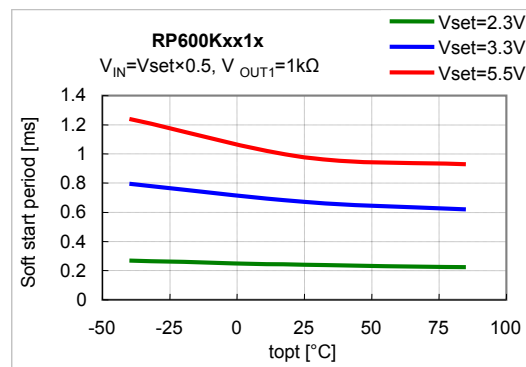

(Over-current protection operation)

If the Lx peak current may reach 1.4A (typ.), Lx peak current limit circuit may operate and control the duty ratio. If the output voltage becomes down to typically 0.5V or less, the switching stops to protect the IC. However, large current flows between Vin and GND via an external component.

(2) LDO

Typically 1.6ms from starting the soft-start operation of the DC/DC converter, LDO starts up its operation. When the LDO starts up, to suppress the inrush current, LDO operation will start with soft-start and typically 0.2ms, reaches the set output voltage.

Until the output voltage reaches to set output voltage, the maximum current limits around the short current limit. Depending on the load condition and the capacity of the capacitor, C2, the start-up time will be long.

(Over current protection operation)

The LDO has an over-current limit circuit, and if the DCDC converter limits the over current typically 0.2ms or longer than 0.2ms, then LDO will be into standby mode.

After that, when the DC/DC converter becomes VFM mode, or normal PWM mode again, then restart with soft-start operation.

If DC/DC converter becomes low-boost mode, or short protect condition, then 1.6ms from the soft-start of DC/DC converter, LDO also restarts with soft-start operation.

TIMING CHART (B version)

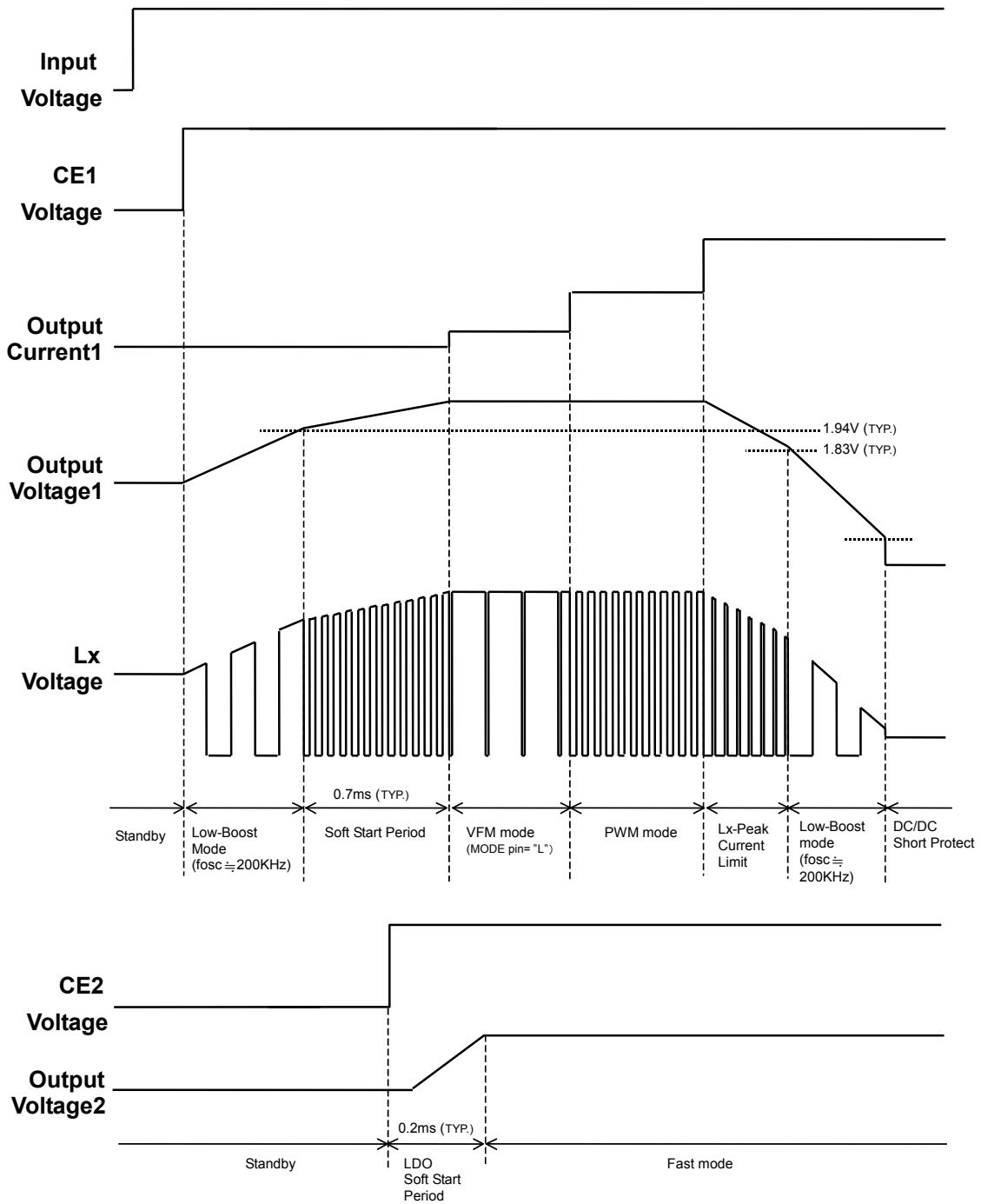

(1) DC/DC Converter

(Start-up) When the CE signal changes from "L" to "H", the DC/DC converter starts up.

The DC/DC converter of the RP600K can start up with the low input voltage such as 0.8V. To realize this, the RP600 has a low-boost mode. Until the output voltage 1 reaches 1.94V (Typ.), the operation mode is low-boost mode. When the output voltage becomes equal or more than 1.94V, then to suppress the inrush current, soft-start operation starts until the output voltage 1 becomes set output voltage.

*At the low-boost mode, the oscillator frequency becomes low, 200kHz (Typ.) Therefore, compared with the normal operation mode at 1.2MHz, the boost ability will worse.

Soft-start time depends on the set output voltage, the input voltage, the ambient temperature, and the load current.

Soft start period vs. Input Voltage

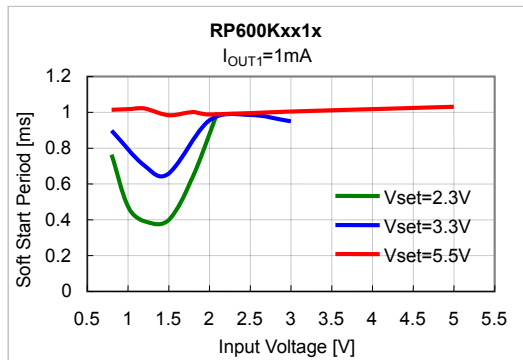

Soft start period vs. Temperature

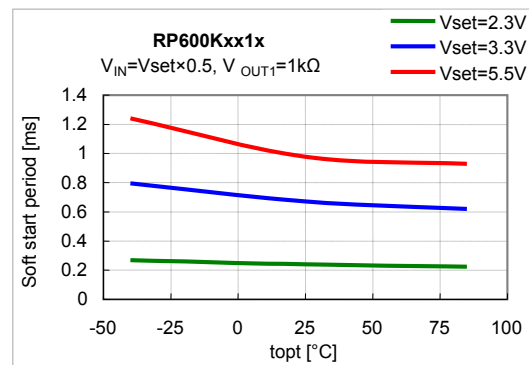

(Over-current protection operation)

If the Lx peak current may reach 1.4A (typ.), Lx peak current limit circuit may operate and control the duty ratio. If the output voltage1 becomes down to typically 0.5V or less, the switching stops to protect the IC. However, large current flows between Vin and GND via an external component.

(2) LDO

When the CE2 signal changes from "L" to "H", LDO starts up.

When the LDO starts up, to suppress the inrush current, LDO operation will start with soft-start and typically 0.2ms, reaches the set output voltage.

Until the output voltage reaches to set output voltage, the maximum current limits around the short current limit. Depending on the load condition and the capacity of the capacitor, C2, the start-up time will be long.

(Over current protection operation)

The LDO has an over-current limit circuit, and if the DCDC converter limits the over current typically 0.2ms or longer than 0.2ms, then LDO will be into standby mode.

After that, when the DC/DC converter becomes VFM mode, or normal PWM mode again, then restart with soft-start operation.

If DC/DC converter becomes low-boost mode, or short protect condition, then 1.6ms from the soft-start of DC/DC converter, LDO also restarts with soft-start operation.

TIMING CHART (C version)

Start-up Operation

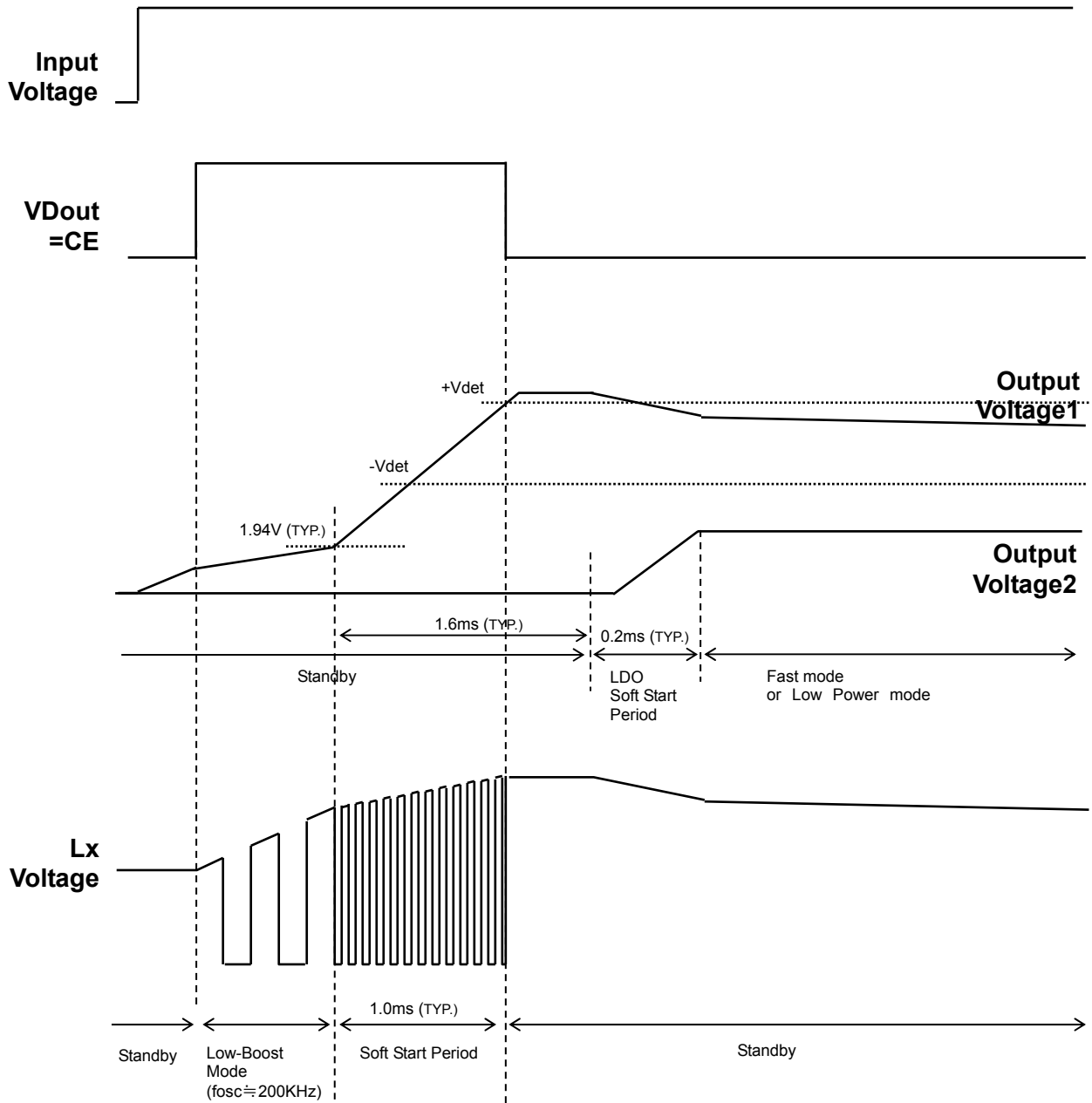

(1) DC/DC Converter and VD

(Start-up) The V_{SENSE} pin is connected to the DC/DC output (V_{OUT1}), and the VD output (V_{DOUT}) is connected to the CE pin.

The V_{OUT1} pin voltage starts up from less than the VD detector threshold ($-V_{DET}$), therefore the V_{DOUT} outputs “H” signal and DC/DC converter becomes active mode. The DC/DC converter of the RP600 can start up with the low input voltage such as 0.8V. To realize this, the RP600 has a low-boost mode. Until the output voltage 1 reaches 1.94V (Typ.), the operation mode is low-boost mode. When the output voltage becomes equal or more than 1.94V, then to suppress the inrush current, soft-start operation starts until the output voltage 1 becomes set output voltage.

*At the low-boost mode, the oscillator frequency becomes low, 200kHz (Typ.) Therefore, compared with the normal operation mode at 1.2MHz, the boost ability will worse.

*Soft-start time depends on the set output voltage, the input voltage, the ambient temperature, and the load current.

Soft start period vs. Input Voltage

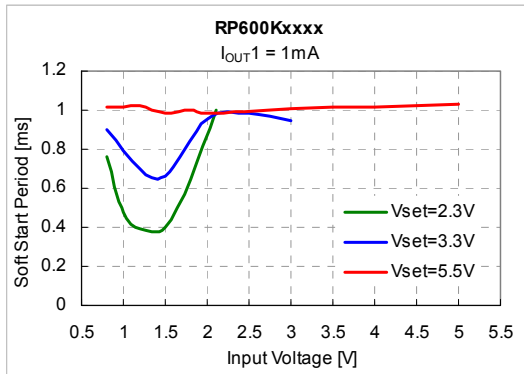

Soft start period vs. Temperature

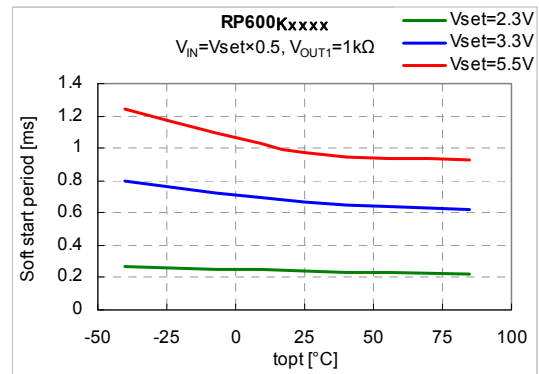

The output voltage 1 continually rises until it reaches to the set output voltage. When it reaches to the VD released voltage* ($+V_{DET}$), V_{DOUT} outputs “L” signal and DC/DC converter becomes standby mode.

*Set $+V_{DET} < V_{OUT1}$

(2) LDO

LDO is always in active mode, however, only at the start-up, LDO starts its operation after 1.6ms (TYP) counting from the beginning of soft-start operation of the DC/DC converter.

When the LDO starts up, to suppress the inrush current, LDO operation will start with soft-start and typically 0.2ms, reaches the set output voltage.

Until the output voltage reaches to set output voltage, the maximum current limits around the short current limit. Depending on the load condition and the capacity of the capacitor, C2, the start-up time will be long.

TIMING CHART (C version)

After Start-up Operation

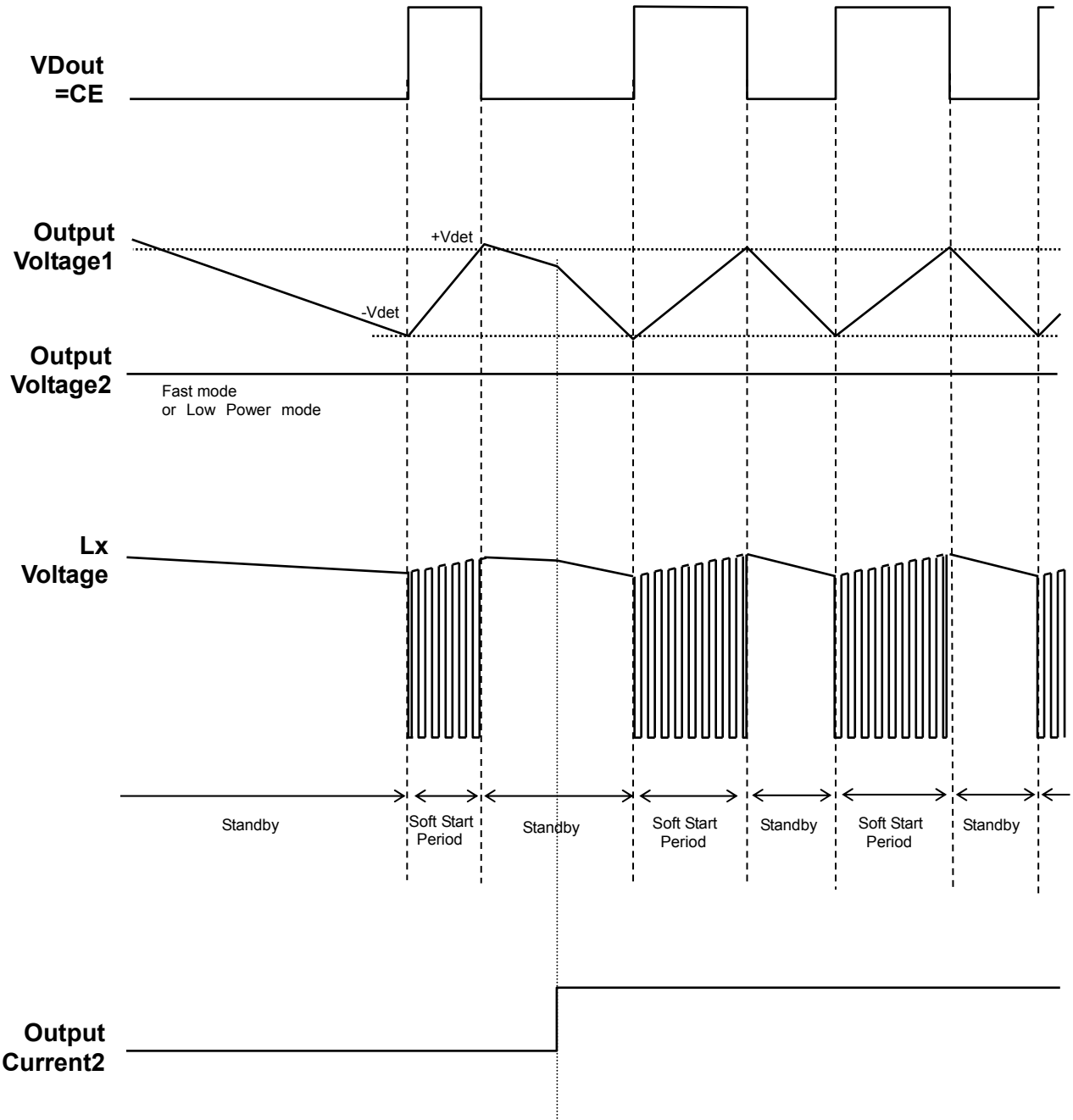

(After Start-up) V_{OUT1} is controlled by the signals sent by V_{DOUT} . When the V_{OUT1} becomes less than V_{DET} ($-V_{DET}$), the V_{DOUT} outputs "H" signal and the DC/DC converter becomes active mode. When the V_{OUT1} becomes more than V_{DET} ($+V_{DET}$), the DC/DC converter outputs "L" signal and the DC/DC converter becomes standby mode. LDO is using V_{OUT1} as a power-supply voltage, therefore it can maintain a desired V_{OUT2} *. If the LDO load is increased, this switching operation interval will be shorter.

*Set $-V_{DET} > V_{OUT2}$

TIMING CHART (B/C version)

LDO mode shift operation

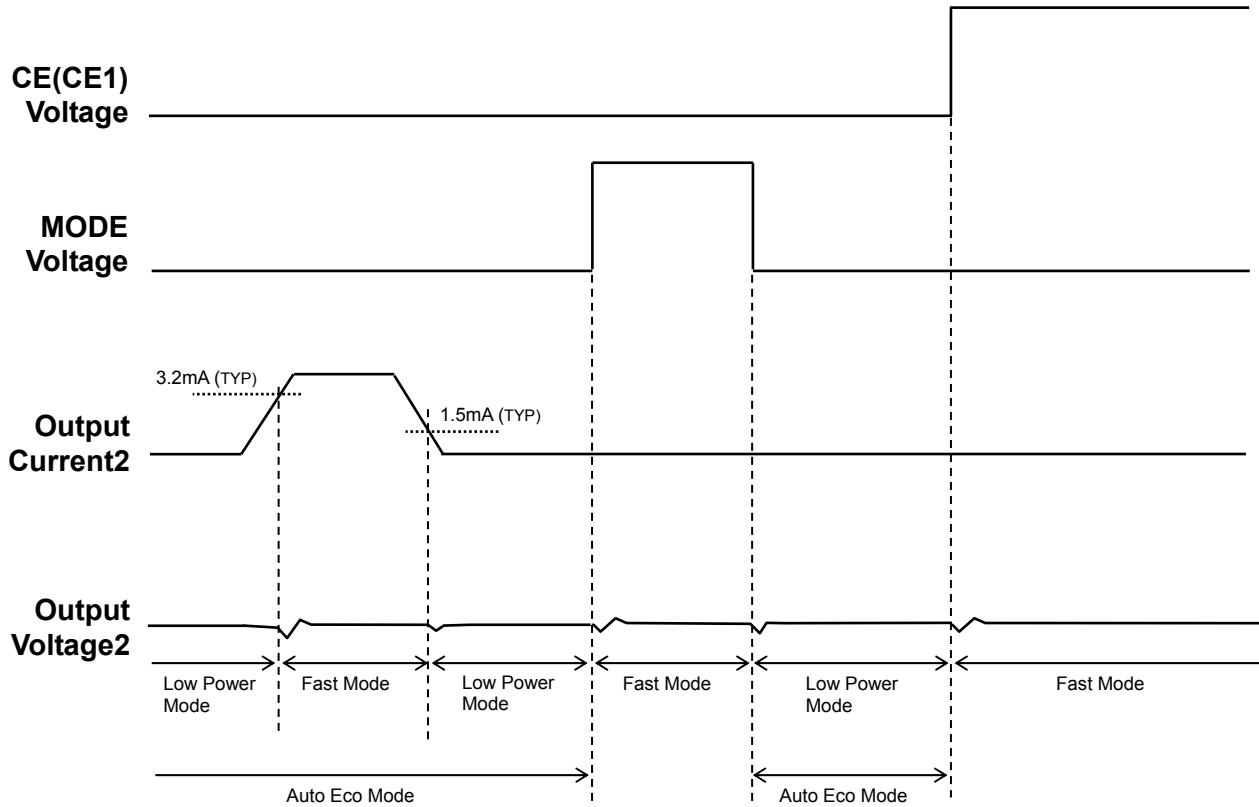

*In the case of CE(1) pin "L" and Mode pin "L"

LDO operates at auto ECO mode, by the load current, the low power mode and the fast mode switch over automatically.

The switchover point is internally fixed.

From the low power mode to the fast mode: switchover current 3.2mA (typ.)

From the fast mode to low power mode: switchover current 1.5mA(typ.)

*In the case of CE(1) pin "L" and Mode pin "H"

LDO always operates at the fast mode regardless of the load current.

*In the case of CE(1) pin "H",

LDO always operates at the fast mode regardless of the condition of MODE pin.

Power Dissipation (DFN(PLP)2527-10)

Power Dissipation (P_D) depends on conditions of mounting on board. This specification is based on the measurement at the condition below:

Measurement Conditions

	High Wattage Land Pattern	Standard Land Pattern
Environment	Mounting on Board (Wind velocity=0m/s)	Mounting on Board (Wind velocity=0m/s)
Board Material	Glass cloth epoxy plastic (4-Layers)	Glass cloth epoxy plastic (Double sided)
Board Dimensions	35mm * 90mm * 0.8mm	40mm*40mm*1.6mm
Copper Ratio	Each layers: Approx. 15%	Top side: Approx. 50%, Back side: Approx. 50%
Through-holes	ϕ 0.30mm * 9pcs ϕ 0.50mm * 10pcs	ϕ 0.54mm * 30pcs

Measurement Result:

($T_a=25^\circ\text{C}$, $T_{j\text{max}}=125^\circ\text{C}$)

	High Wattage Land Pattern	Standard Land Pattern
Power Dissipation	1400mW ($T_{j\text{max}}=125^\circ\text{C}$)	910mW($T_{j\text{max}}=125^\circ\text{C}$)
Thermal Resistance	$\theta_{ja} = (125-25^\circ\text{C})/1.4\text{W} = 71^\circ\text{C/W}$	$\theta_{ja} = (125-25^\circ\text{C})/0.91\text{W} = 110^\circ\text{C/W}$

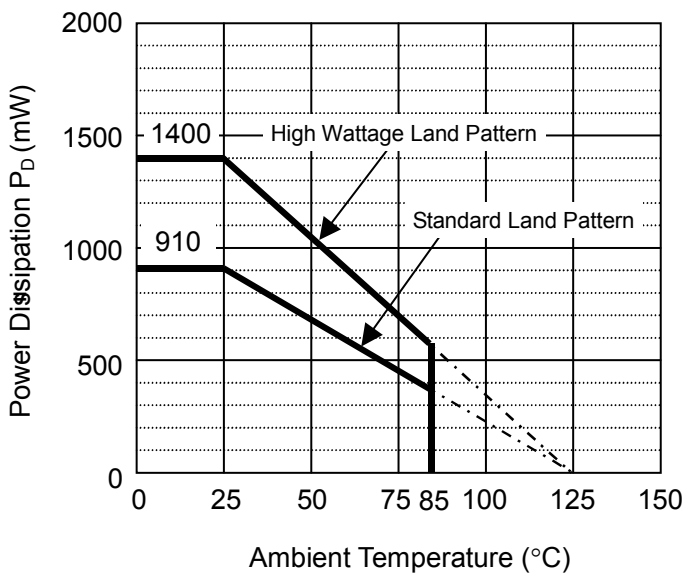

Power Dissipation

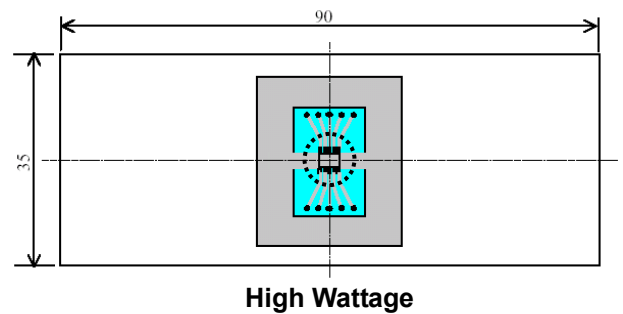

High Wattage

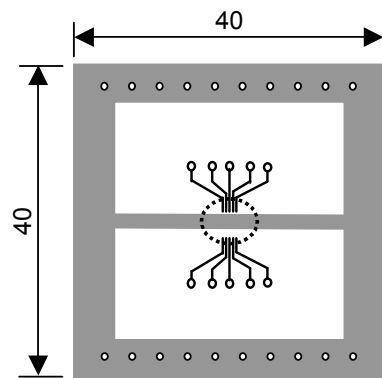

Standard

Measurement Board Pattern

IC Mount Area (Unit : mm)

TYPICAL CHARACTERISTICS

1) Standby Current vs. Temperature

RP600KxxxA/B/D
 $V_{IN}=V_{OUT1}=5.5V, CE(CE1\&CE2)=0V$

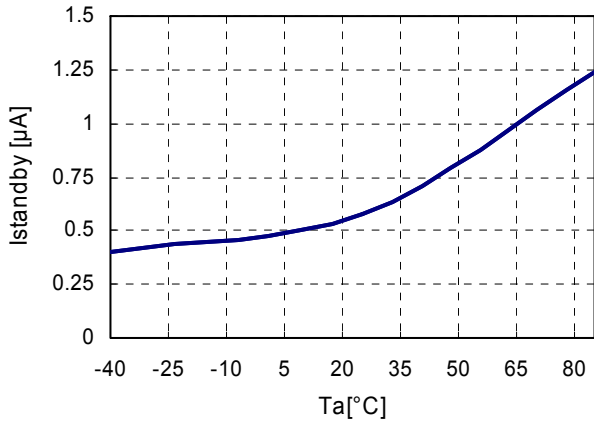

2) CE (or CE1) Input “H” Voltage vs. Temperature

RP600Kxxxx

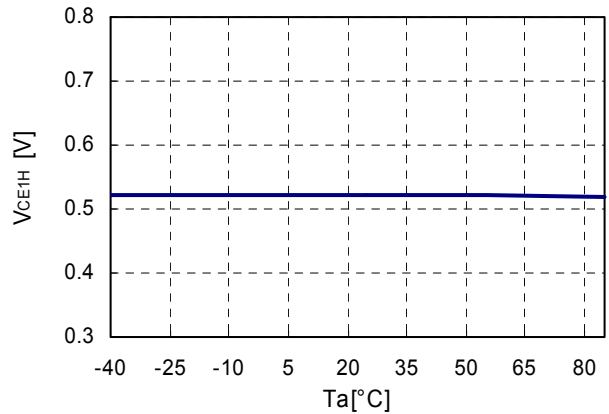

3) CE2 Input “H” Voltage vs. Temperature

RP600K0xxB

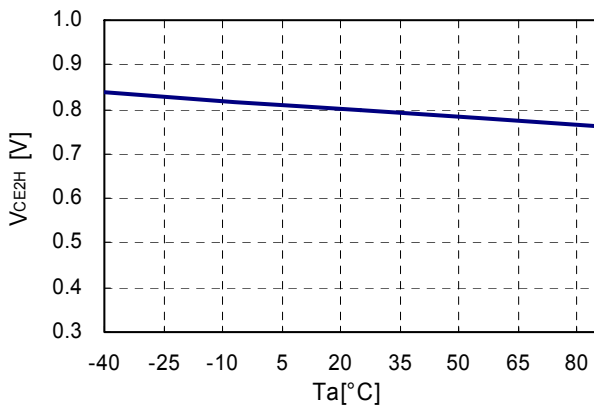

4) MODE Input “H” Voltage vs. Temperature

RP600Kxxxx

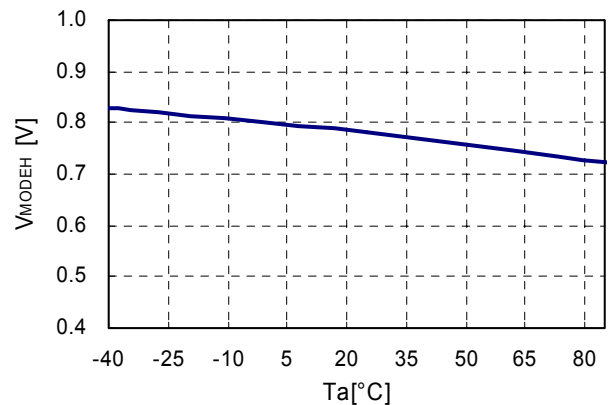

5) Quiescent Current 1 vs. Temperature

RP600Kxxxx

$DC/DC=3.3V, CE(CE1)=(CE2)=5.5V, MODE=“H”$

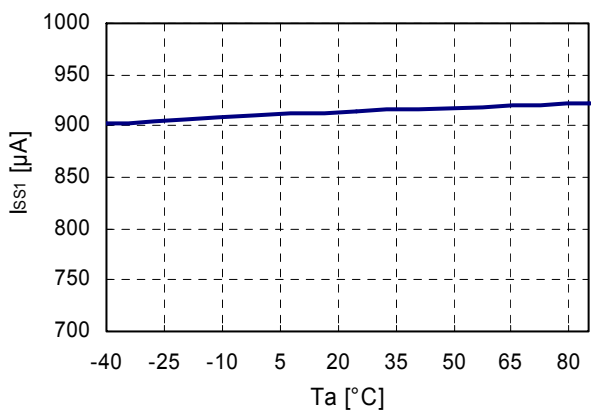

6) Quiescent Current 2 vs. Temperature

RP600Kxxxx

$DC/DC=3.3V, CE(CE1)=(CE2)=5.5V, MODE=“L”$

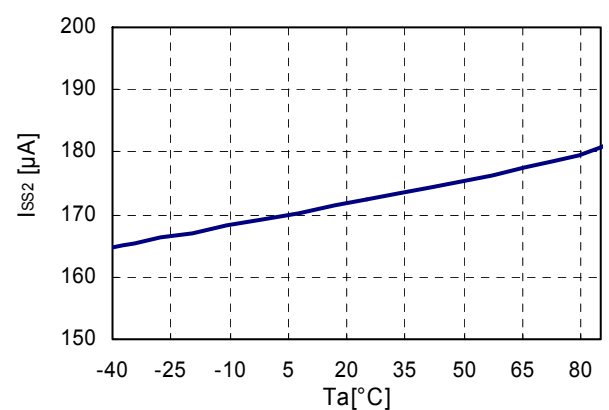

7) Quiescent Current 3 vs. Temperature

RP600K0xxB
DC/DC=3.3V, CE1=5.5V, CE2=0V

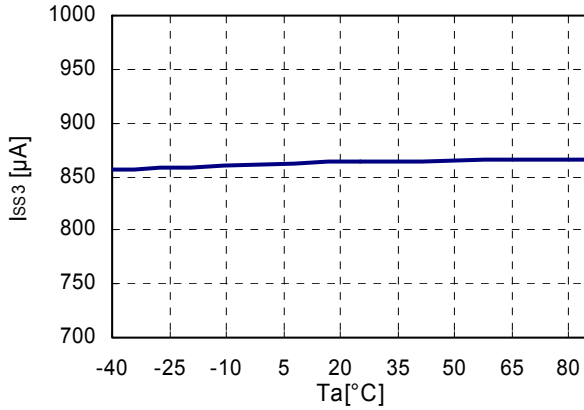

8) Quiescent Current 4 vs. Temperature

RP600K0xxB
DC/DC=3.3V, MODE=0V, CE1=5.5V, CE2=0V

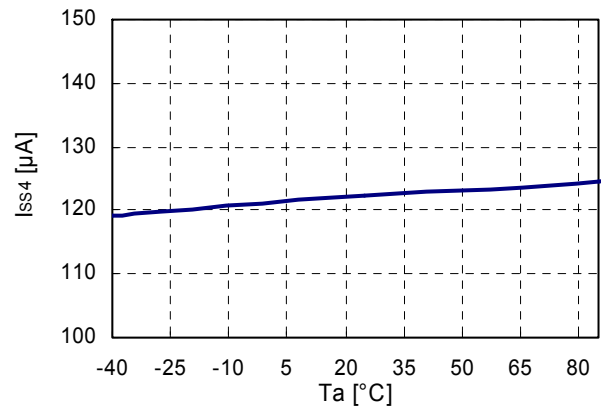

9) Quiescent Current 5 vs. Temperature

RP600K0xxB
LDO=3.3V, MODE="H",
CE1=0V, IOUT2=0mA, CE2=5.5V

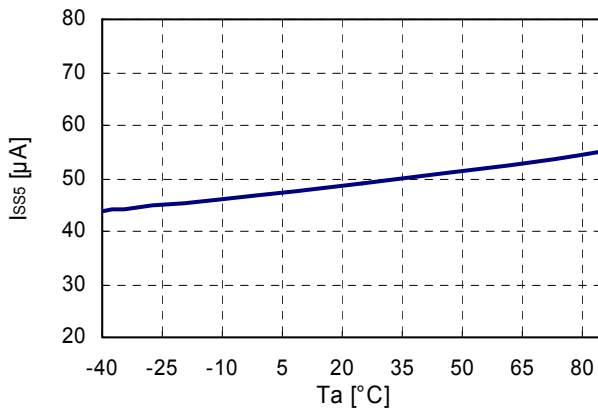

10) Quiescent Current 6 vs. Temperature

RP600K0xxB
LDO=3.3V, MODE="L",
CE1=0V, CE2=5.5V, IOUT2=0mA

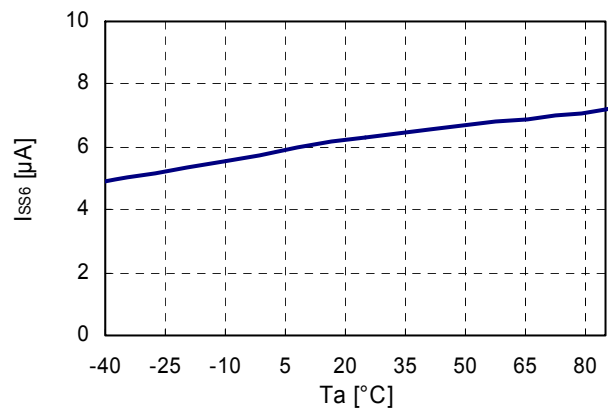

11) Quiescent Current 3 vs. Temperature

RP600K2xxC
LDO=3.3V, MODE="L", CE=0V, IOUT2=0mA

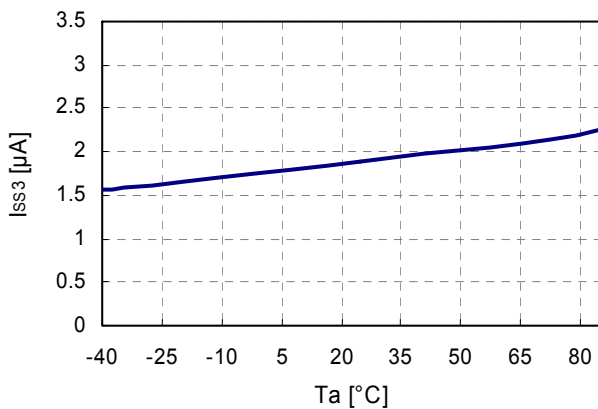

12) Quiescent Current 4 vs. Temperature

RP600K2xxC
LDO=3.3V, MODE="H", CE=0V, IOUT2=0mA

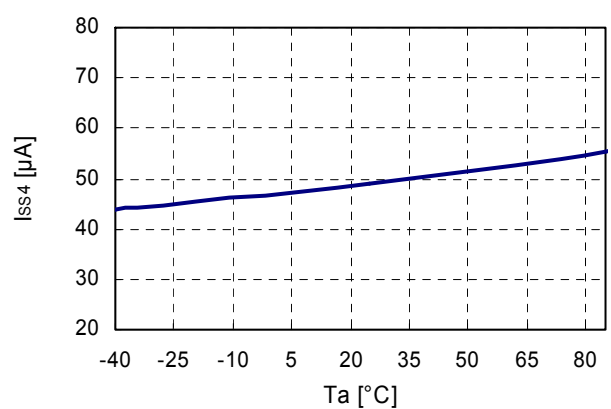

13) Output Voltage 1 vs. Output Current 1

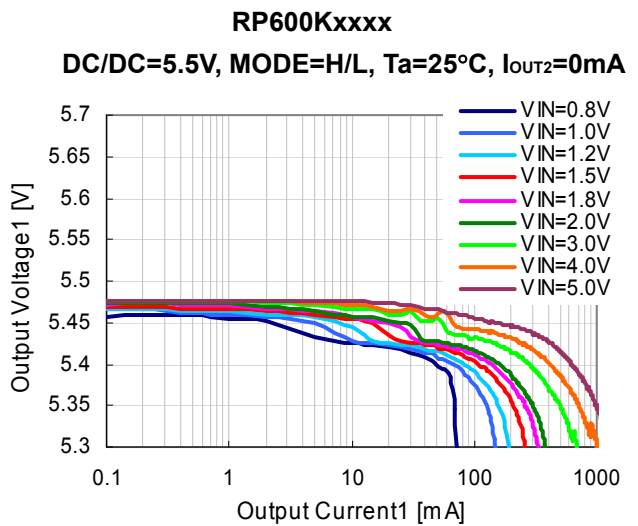
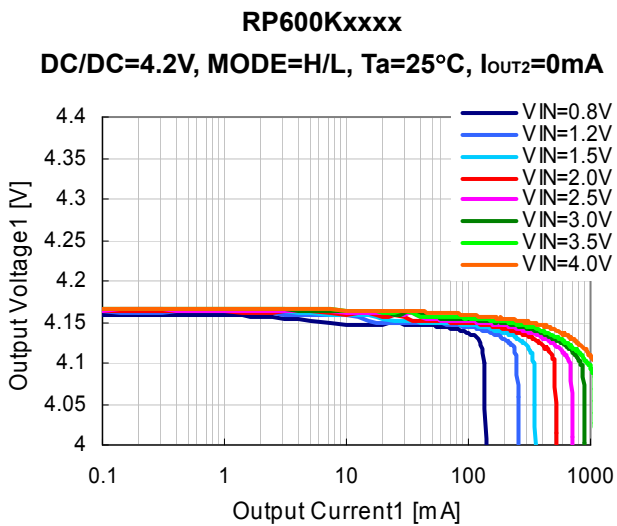
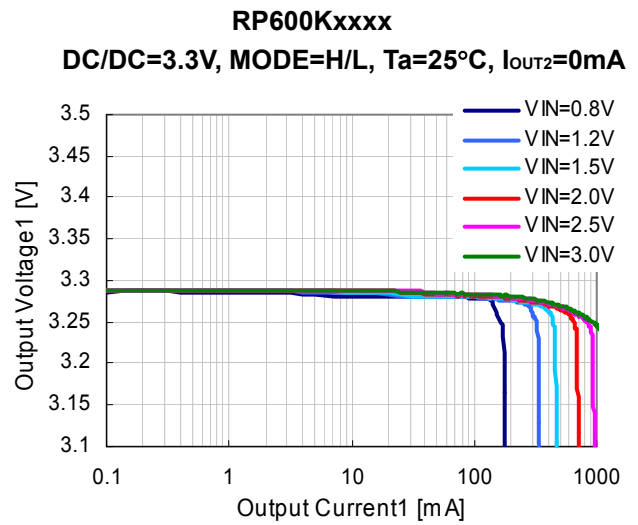
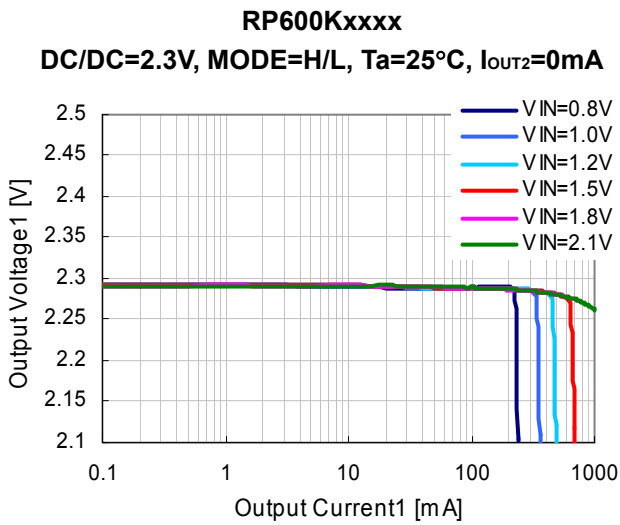

14) Efficiency vs. Output Current 1

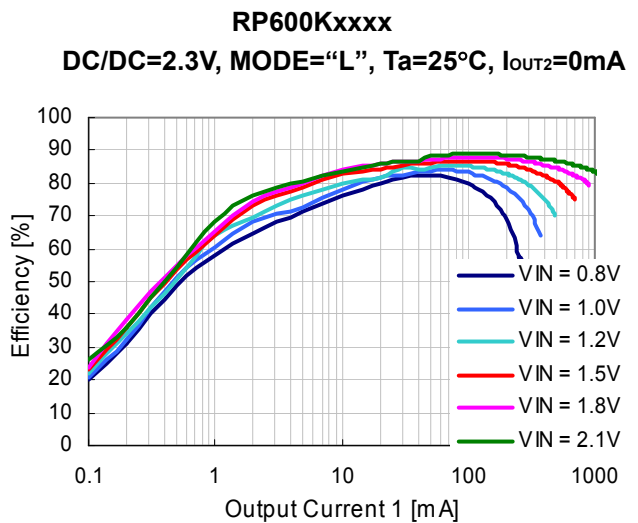
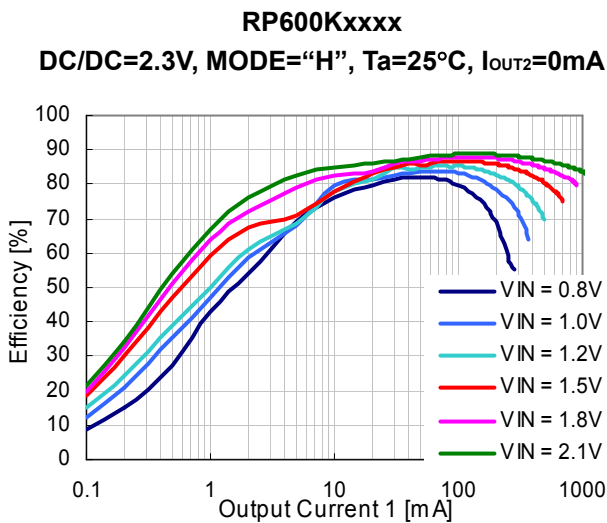

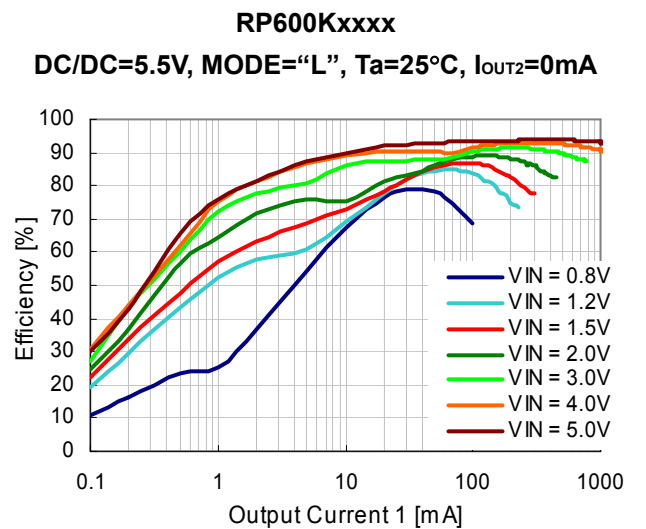
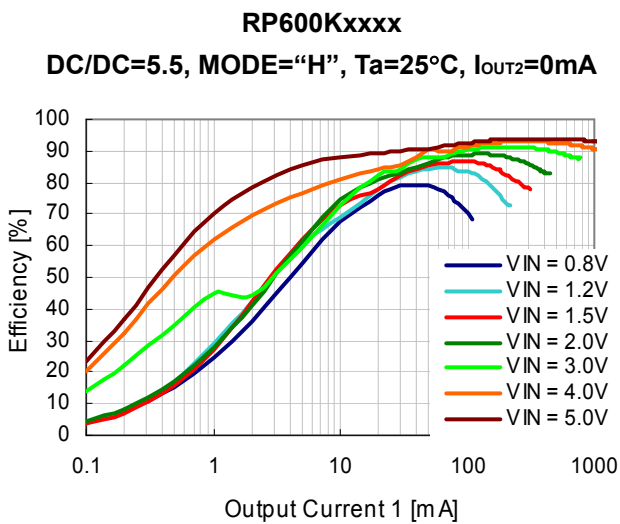
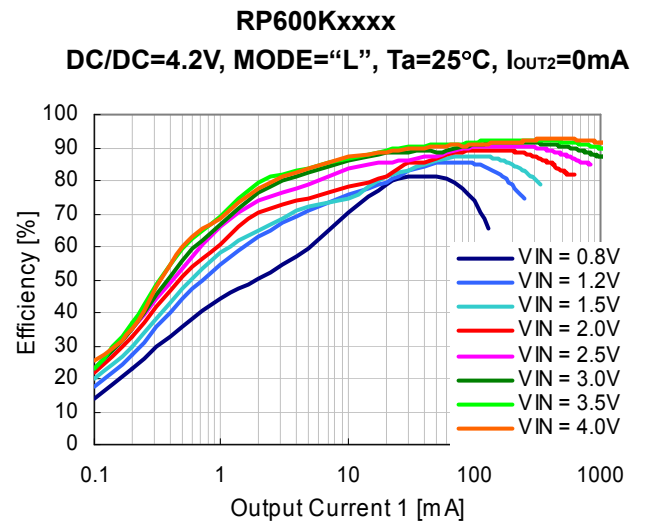
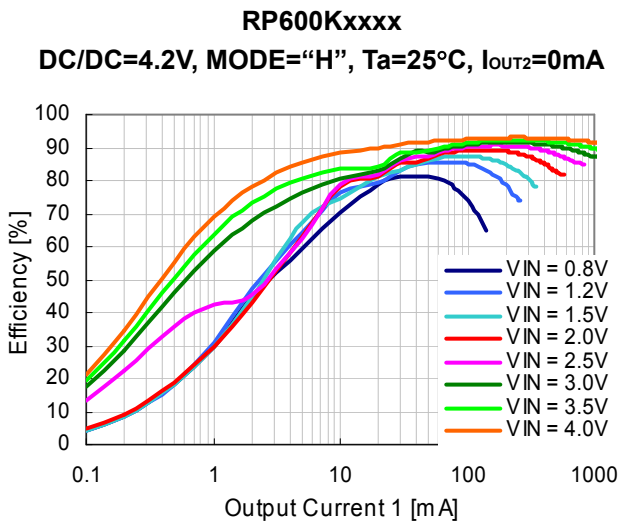
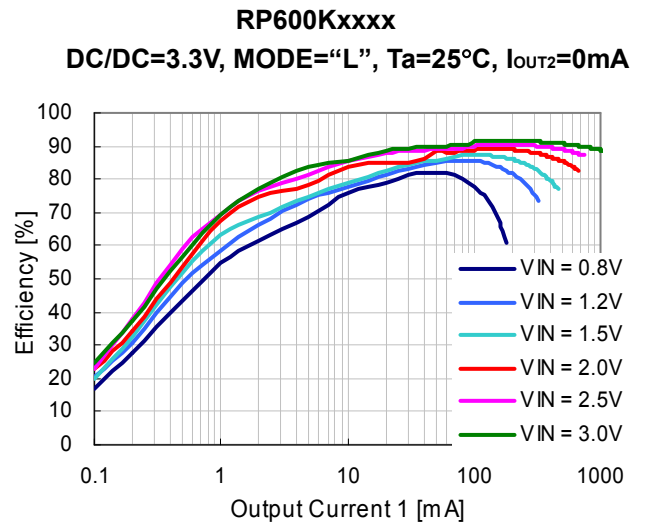
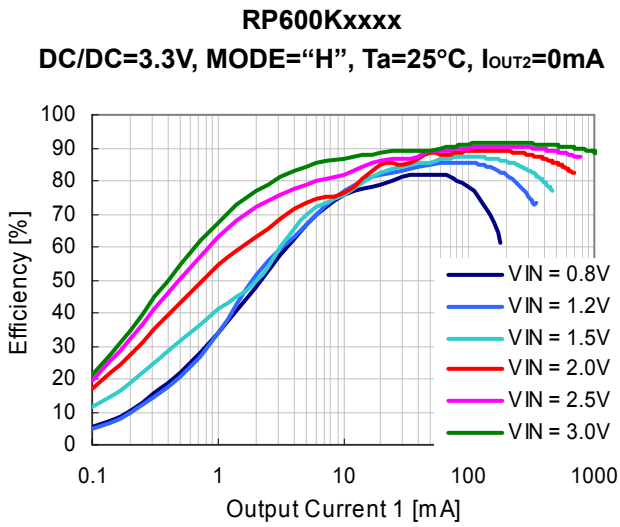

15) Output Voltage 1 (or VFB) vs. Temperature

RP600KxxxA/B/C
DC/DC=3.3V

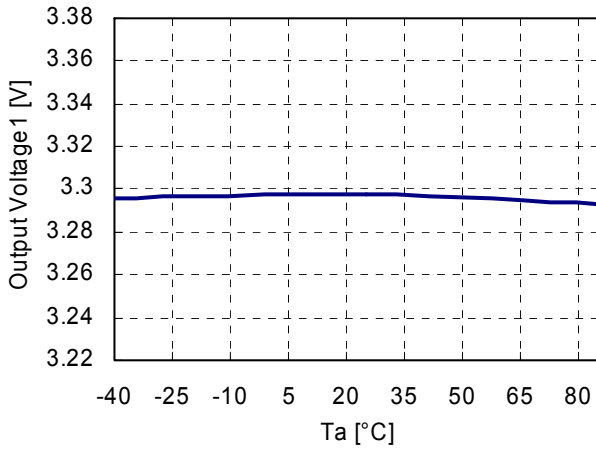

RP600K1xxD

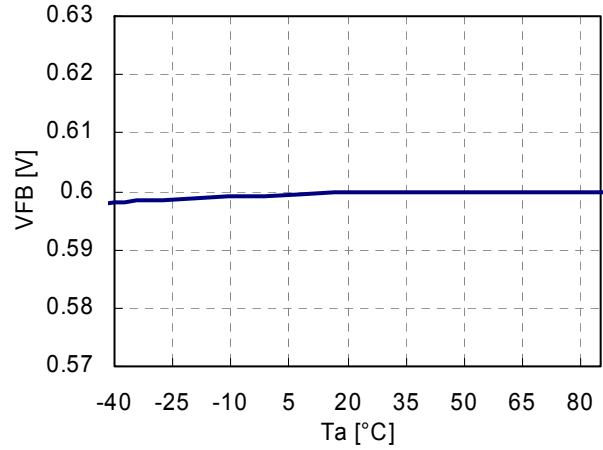

16) Maximum Duty Cycle vs. Temperature

RP600Kxxxx

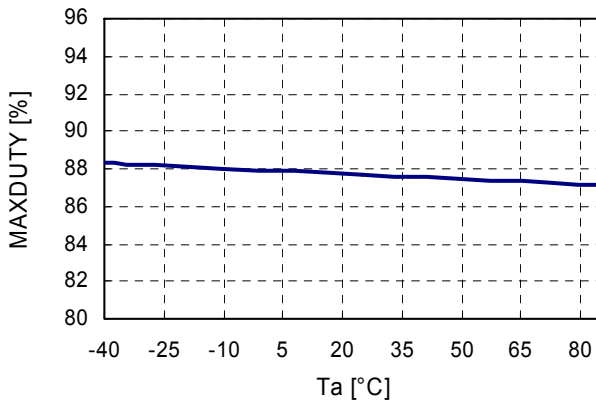

17) Start-up Voltage vs. Temperature

RP600Kxxxx
DC/DC=5.5V, I_{OUT1}=-1mA, CE(CE1)=V_{OUT1}

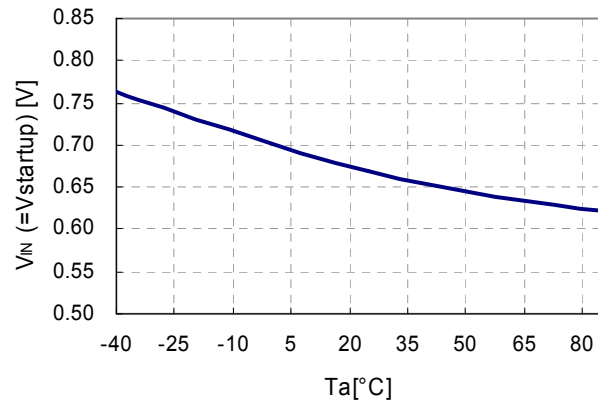

18) DC/DC Soft start time vs. Temperature

RP600Kxxxx

V_{IN}=V_{set}×0.5, V_{OUT}=1kΩ, I_{OUT2}=0mA

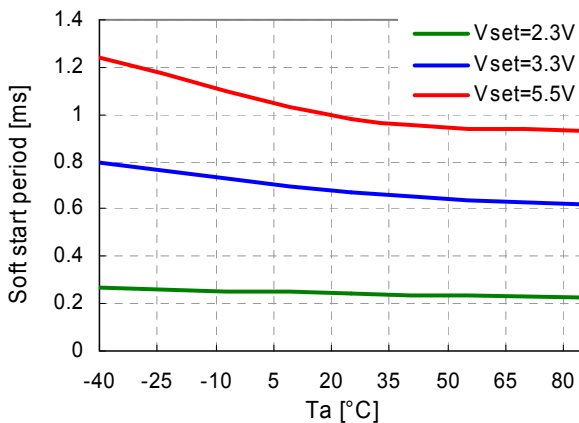

19) DC/DC Soft start time vs. Input Voltage

RP600Kxxxx

$I_{OUT1}=-1mA, I_{OUT2}=0mA$

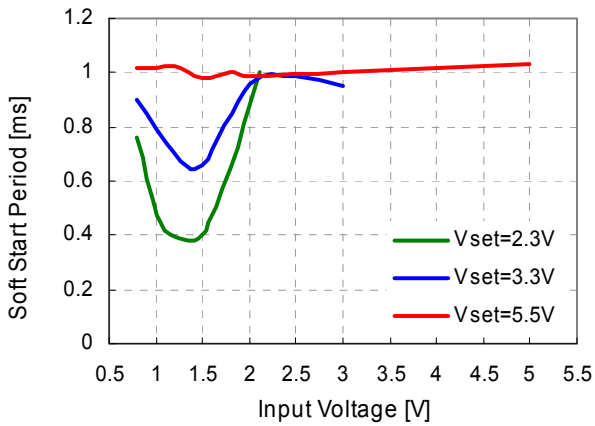

20) Switching Frequency vs. Temperature

RP600Kxxxx

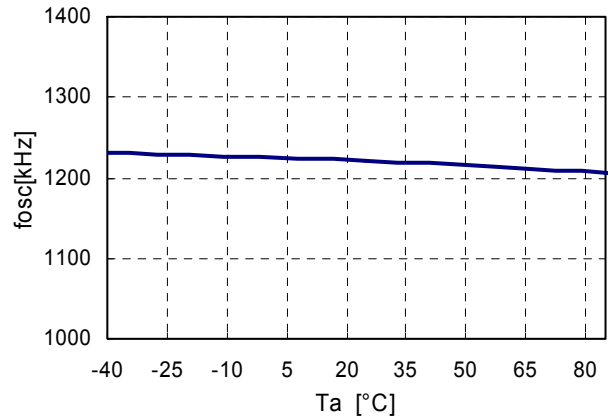

21) Lx Current Limit vs. ON Duty

RP600Kxxxx

DC/DC=2.3V

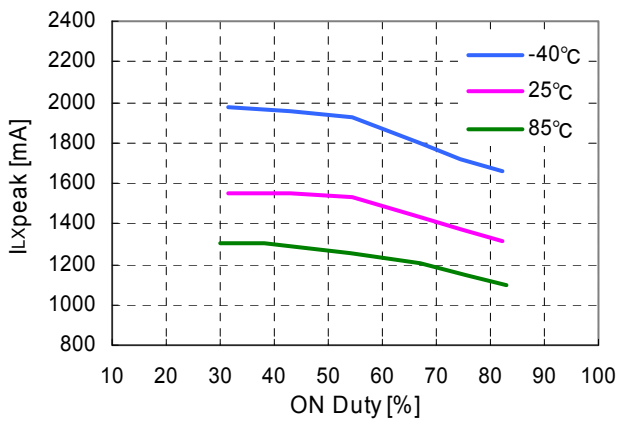

RP600Kxxxx

DC/DC=4.2V

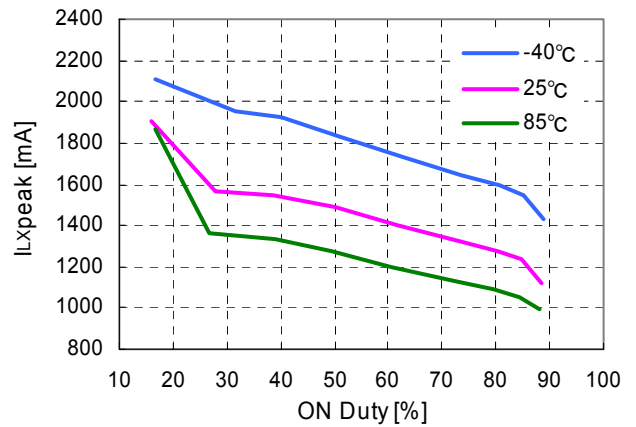

22) Lx Current Limit vs. Temperature

RP600Kxxxx

DC/DC=2.3V

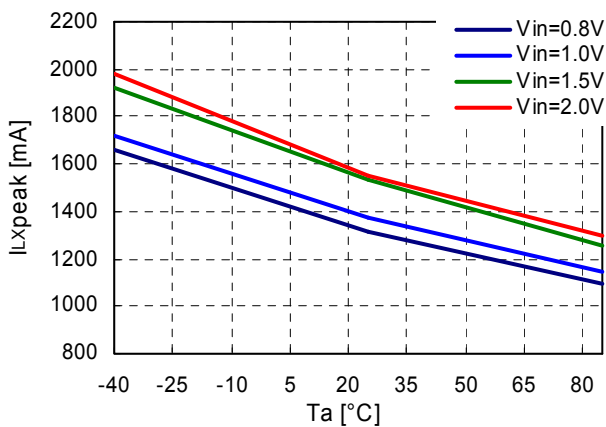

RP600Kxxxx

DC/DC=4.2V

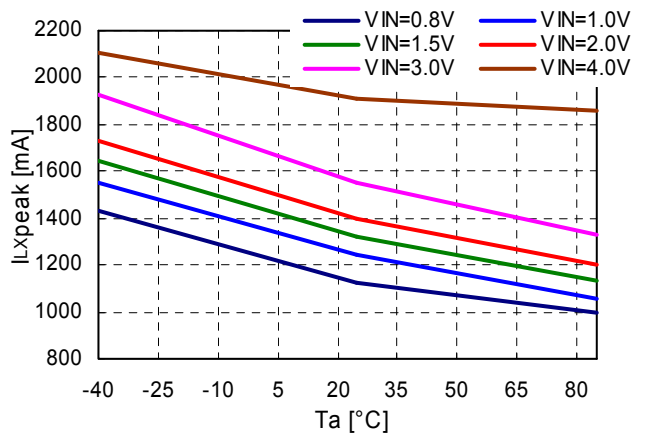

23) Hold-on Voltage vs. Temperature

RP600Kxxxx

$I_{OUT1}=-1mA, I_{OUT2}=0mA$

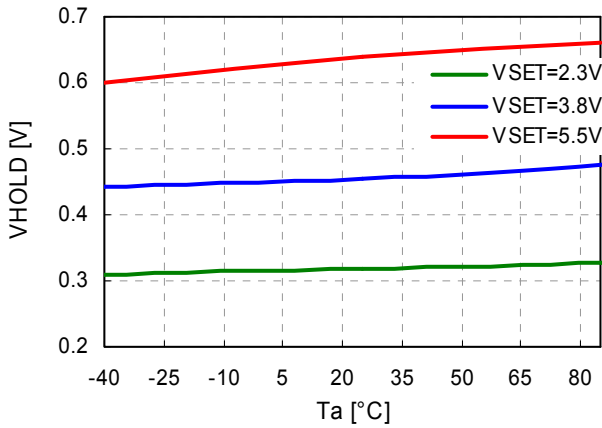

24) Output Voltage vs. Output Current 2

RP600KxxxxA/D

LDO=3.3V, Ta=25°C

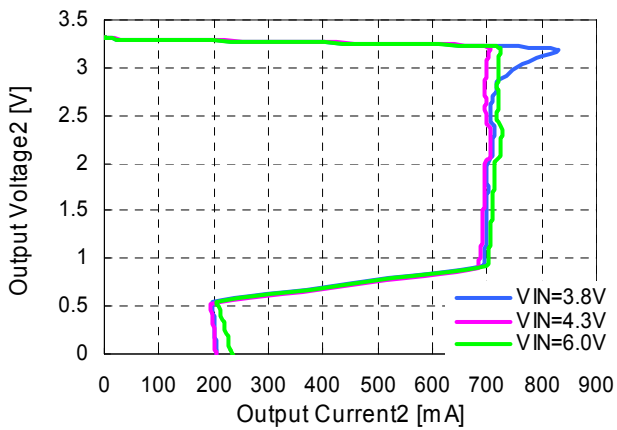

RP600K0xxB

LDO=3.3V, Ta=25°C

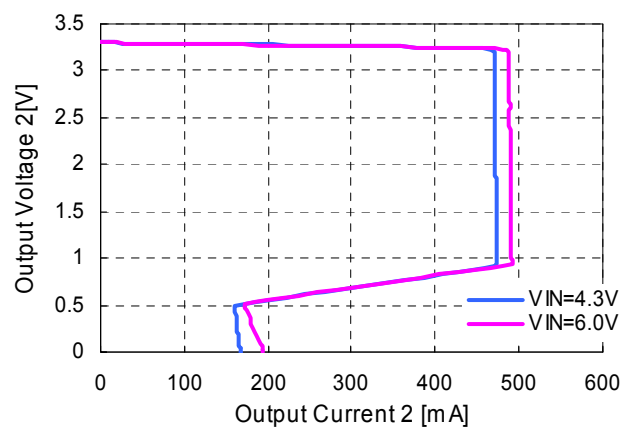

RP600K2xxC

LDO=3.3V, Ta=25°C

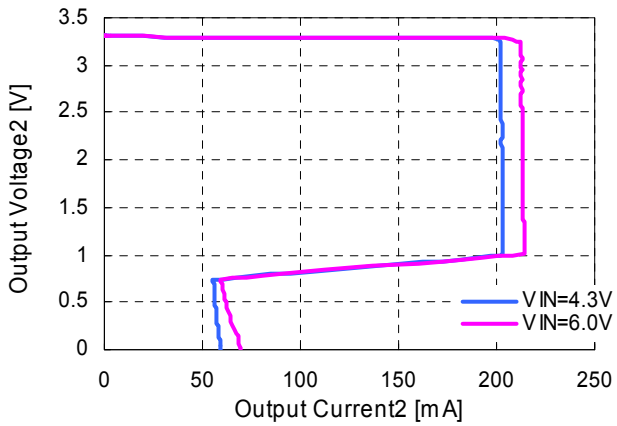

25) Output Voltage 2 vs. Input Voltage

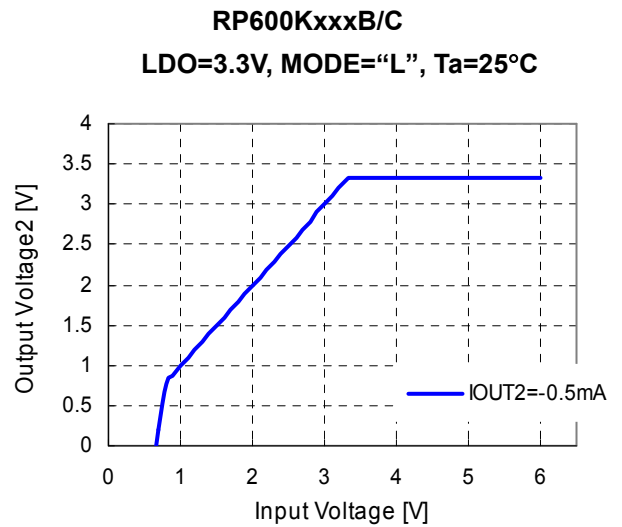
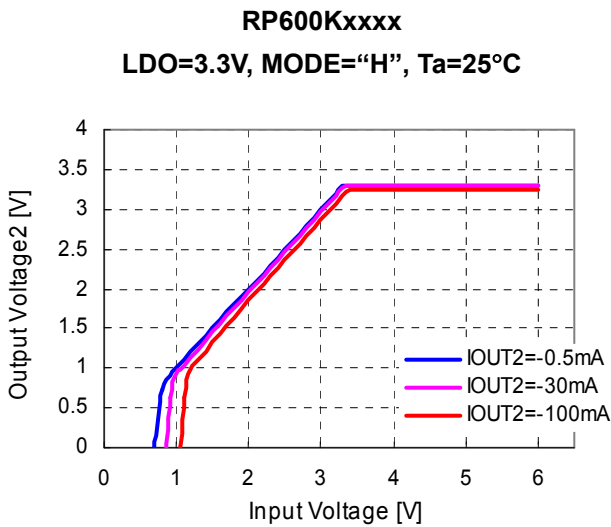

26) Quiescent Current 5 vs. Input Voltage

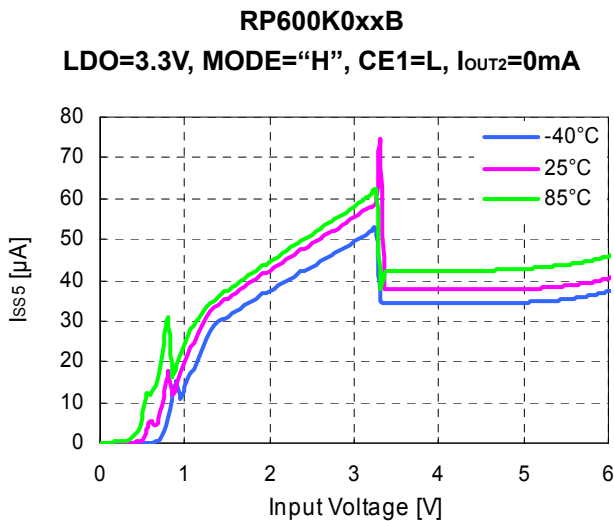

27) Quiescent Current 4 vs. Input Voltage

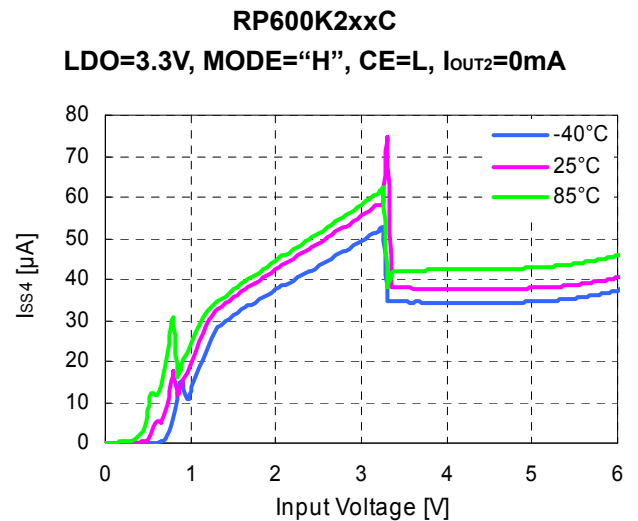

28) Quiescent Current 6 vs. Input Voltage

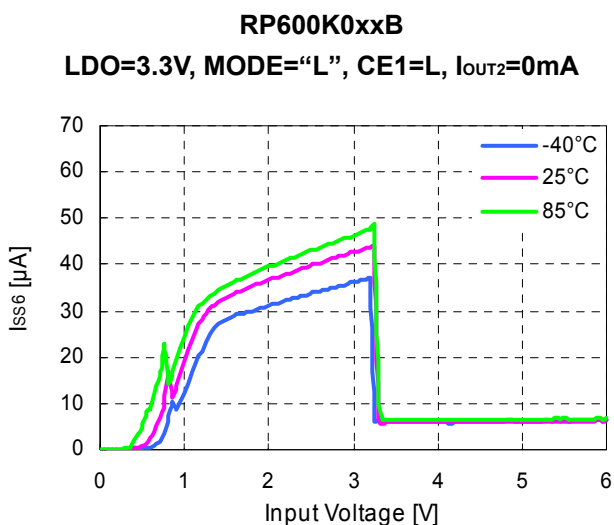

29) Quiescent Current 3 vs. Input Voltage

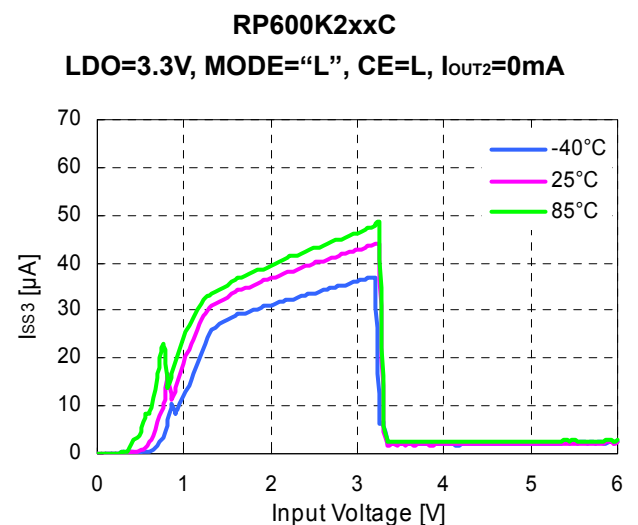

30) Supply Current LDO vs. Output Current

RP600K0xxB

LDO=3.3V, MODE="L", CE1=L, Ta=25°C

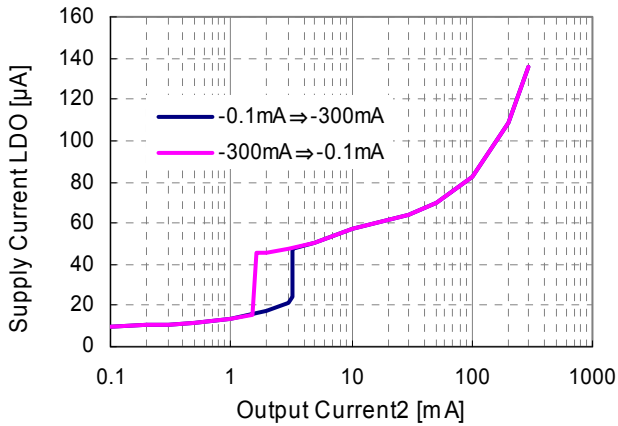

RP600K2xxC

LDO=3.3V, MODE="L", CE=L, Ta=25°C

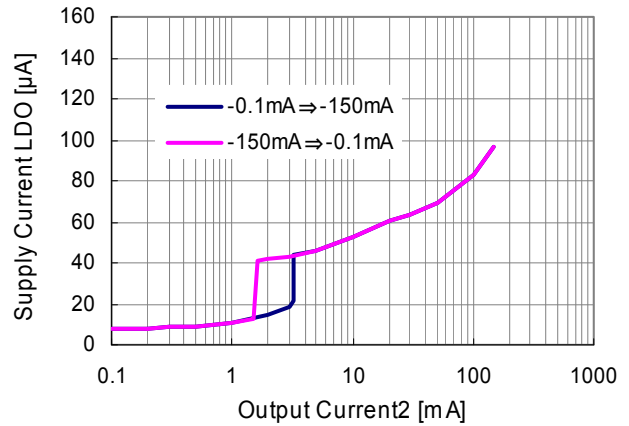

31) Output Voltage 2 vs. Temperature

RP600Kxxxx

LDO=3.3V, MODE="H", IOUT2=-1mA

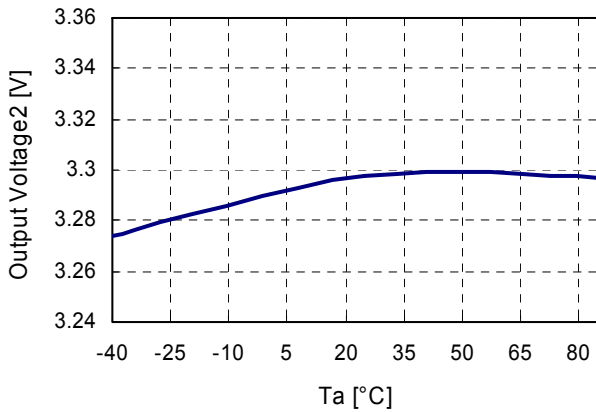

RP600Kxxxx

LDO=3.3V, MODE="L", IOUT2=-0.5mA

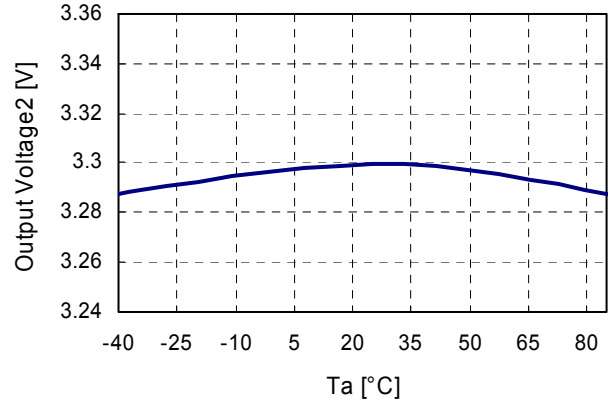

32) Dropout Voltage 2 vs. Output Current 2

RP600KxxxA/D

LDO=1.5V

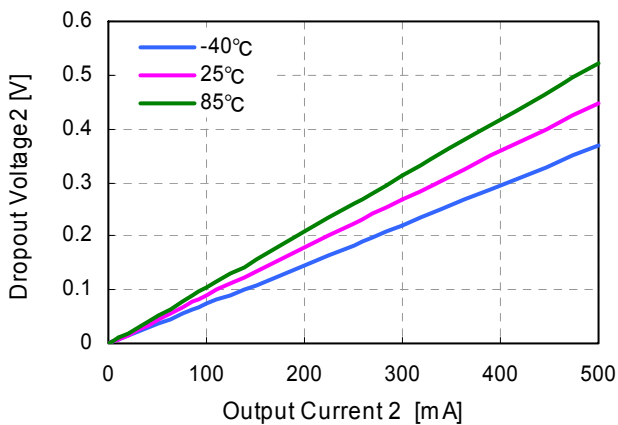

RP600KxxxA/D

LDO=3.3V

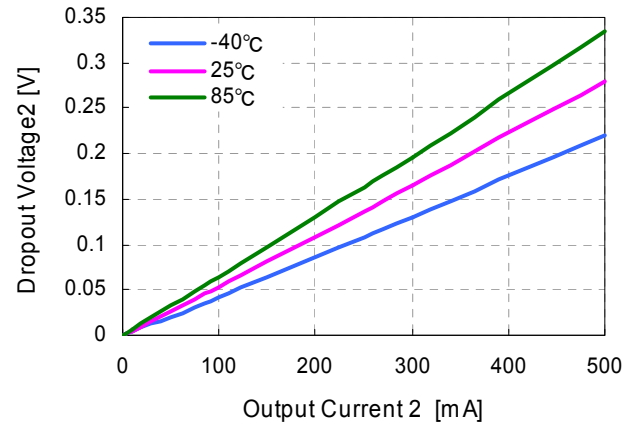

RP600KxxxA/D
LDO=5.0V

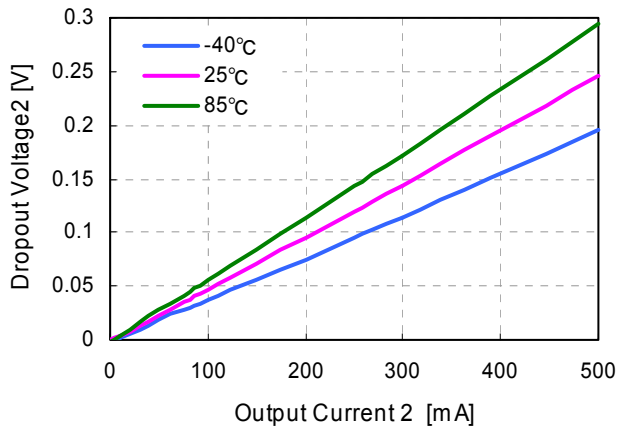

RP600K0xxB
LDO=1.5V

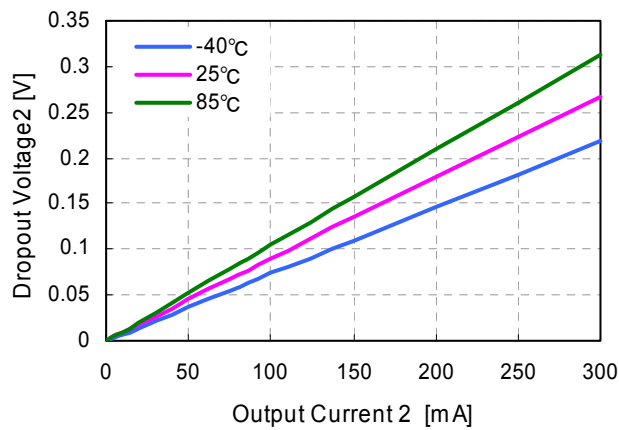

RP600K0xxB
LDO=3.3V

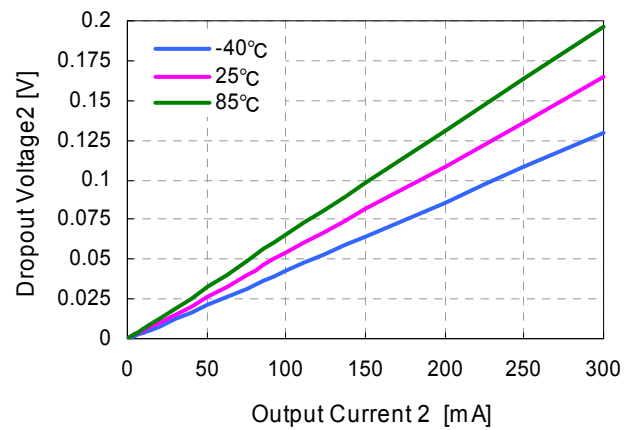

RP600K0xxB
LDO=5.0V

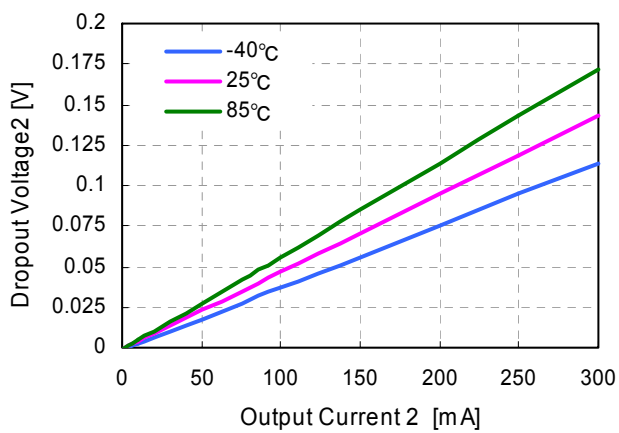

RP600K2xxC
LDO=1.5V

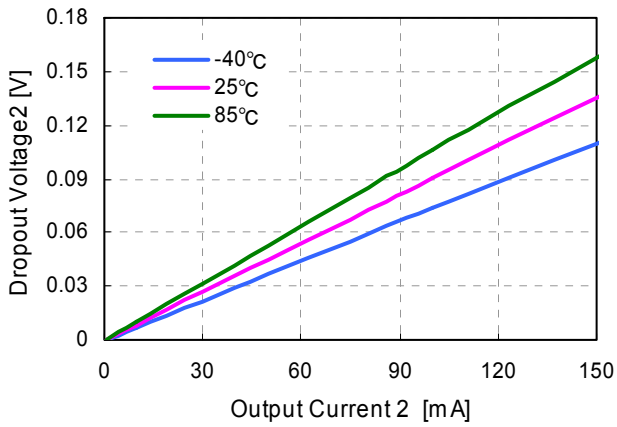

RP600K2xxC
LDO=3.3V

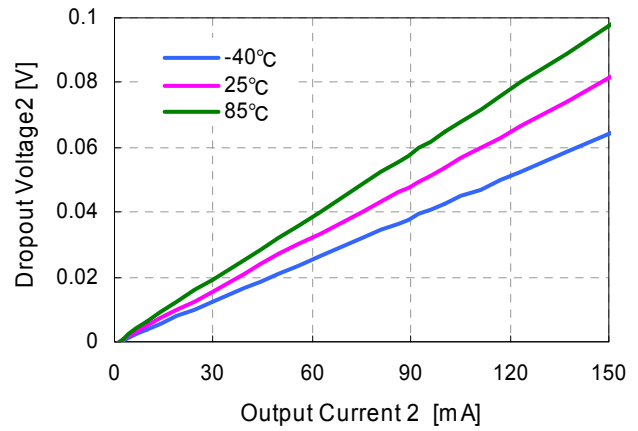

RP600K2xxC
LDO=5.0V

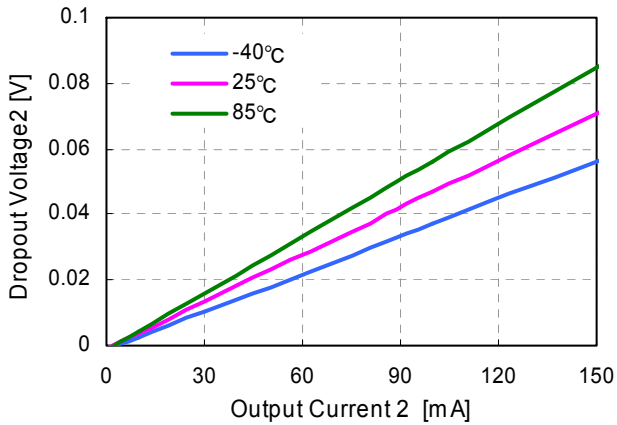

33) Dropout Voltage 2 vs. LDO_Vset

RP600Kxxxx, Ta=25°C

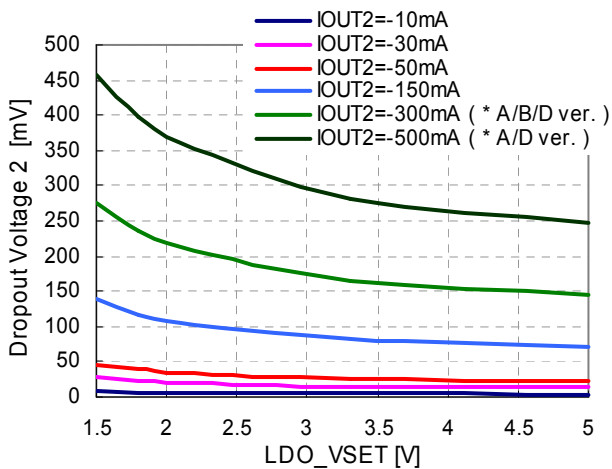

34) LDO Ripple Rejection vs. Input Voltage

RP600Kxxxx

LDO=3.3V, MODE="H", Ta=25°C, IOUT2=-30mA

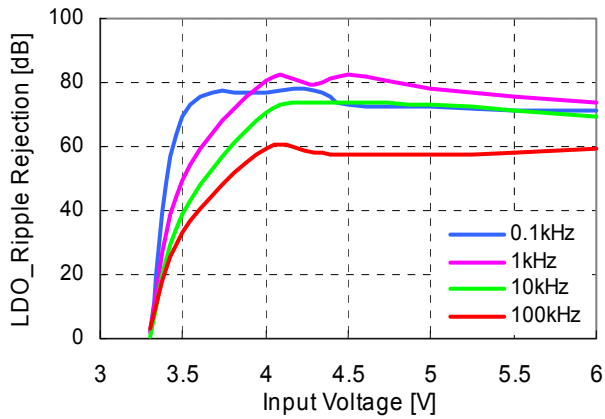

35) LDO Ripple Rejection vs. Frequency

RP600Kxxxx

LDO=3.3V, MODE="H", Ta=25°C, VIN=4.3V+0.2Vp-p

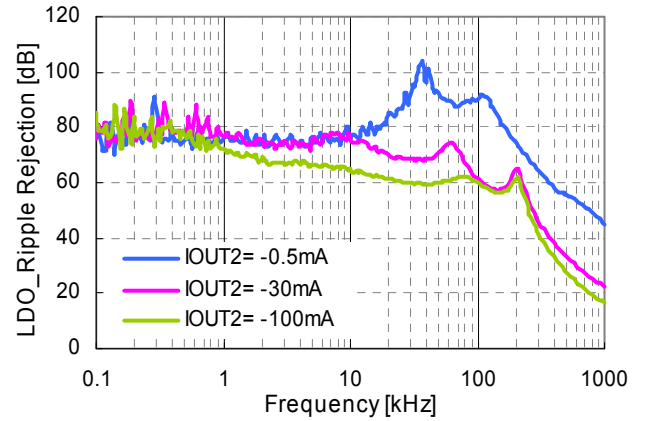

36) LDO ESR vs. Output Current 2

RP600Kxxxx (MODE="H")

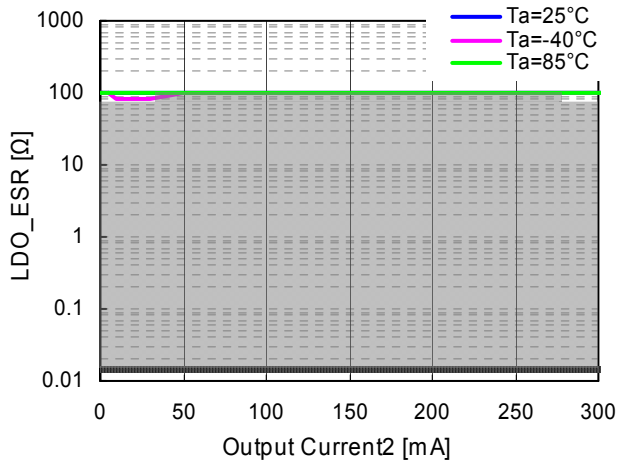

37) LDO ESR vs. Output Current 2

RP600Kxxxx (MODE="L")

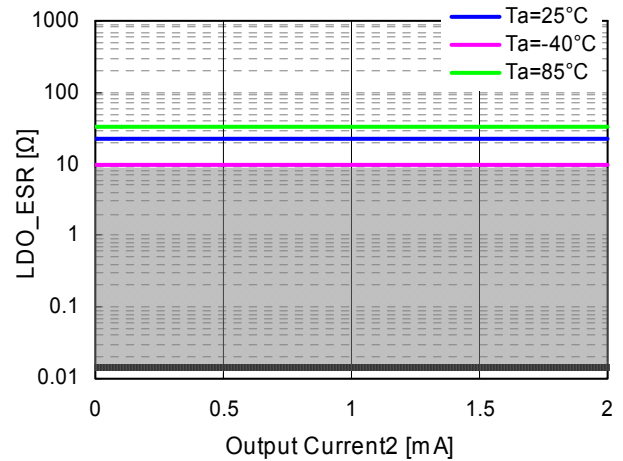

38) Detector Threshold Range vs. Temperature

RP600Kxxxx

-Vdet=4.5V

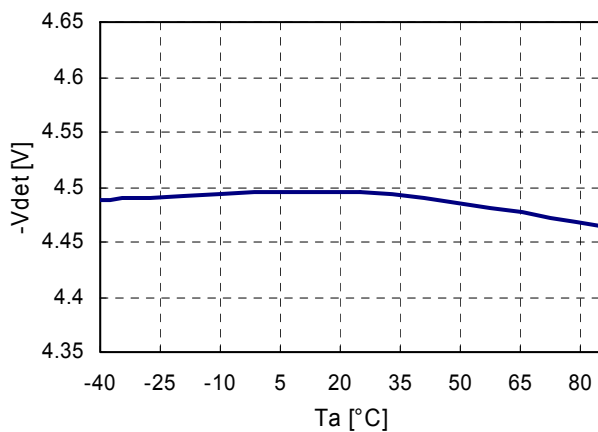

39) Detector Threshold Range vs. Input Voltage

RP600Kxxxx

-Vdet=4.5V

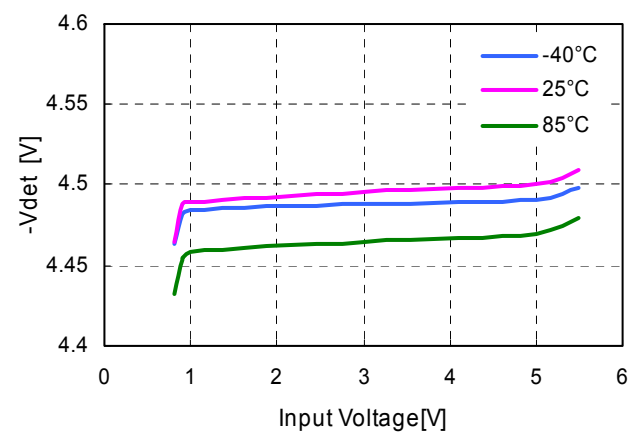

40) Detector Threshold Hysteresis vs. Temperature

RP600KxxxA/B/D
VIN=3.0V

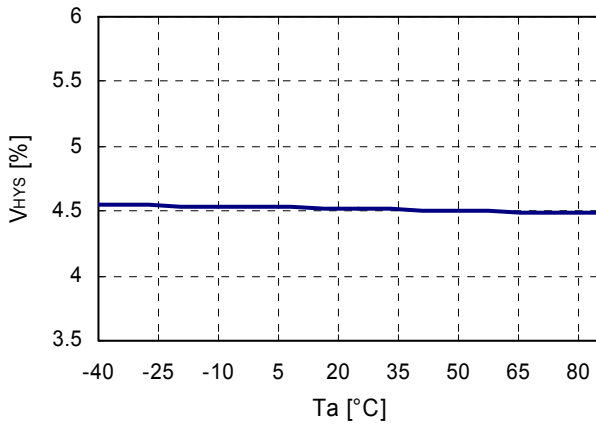

RP600K2xxC
VIN=3.0V, HYS=30%

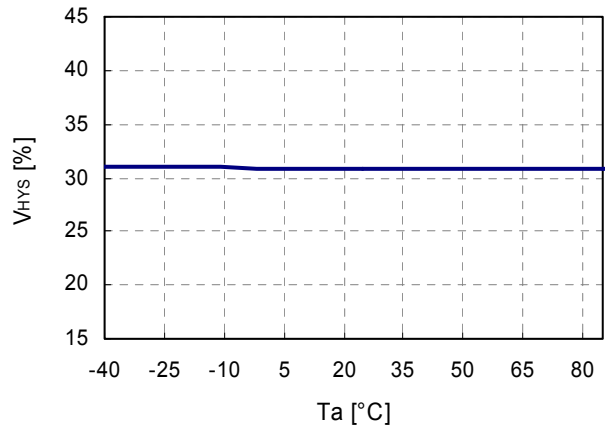

41) Detector Threshold Hysteresis vs. Input Voltage

RP600KxxxA/B/D

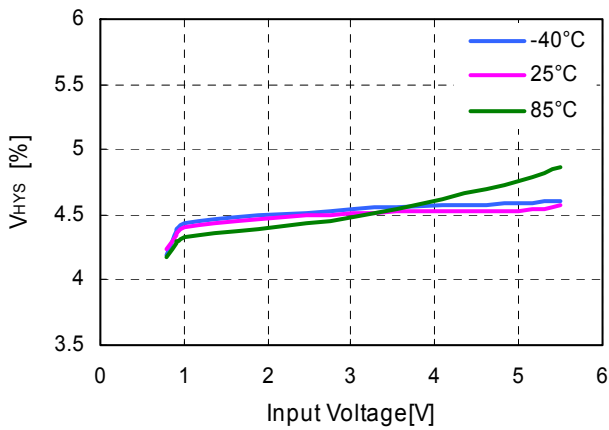

RP600K2xxC
HYS=30%

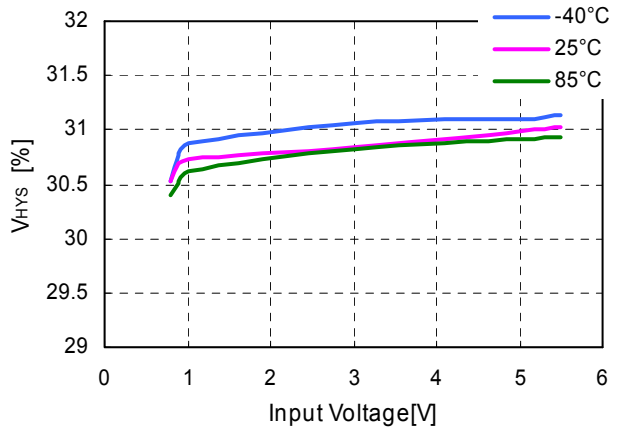

42) VDOUT vs. Input Voltage

RP600Kxxxx

-Vdet=4.5V, VSENSE=0V(A/B/D) or 5V(C), VDOUT=100kΩ_Vinpullup

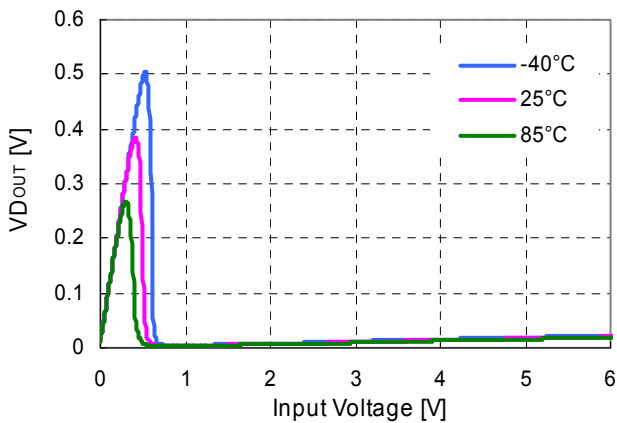

43) Nch Driver Output Current vs. VDOUT

RP600Kxxxx

-Vdet=4.5V, Ta=25°C, VSENSE=0V(A/B/D) or 5V(C)

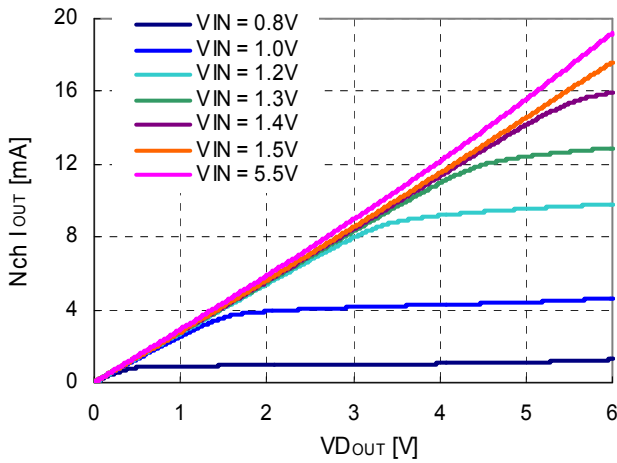

44) Nch Driver Output Current vs. Input Voltage

-Vdet=4.5V, V_{DOUT}=0.1V, VSENSE=0V(A/B/D) or 5V(C)

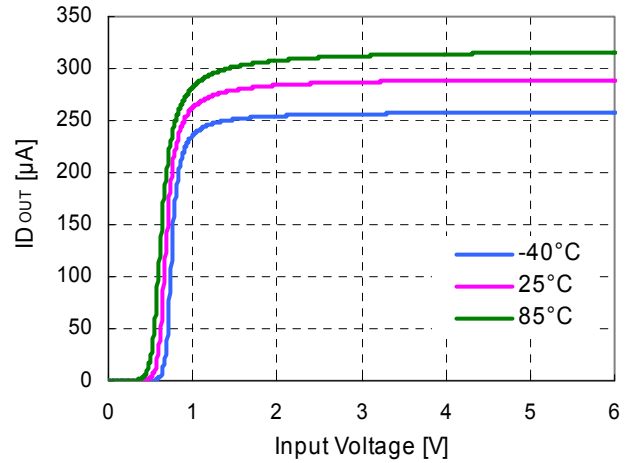

45) Voltage Detector Released Output Delay Time vs. Temperature

RP600KxxxxA/B/D

V_{IN}=3.0V

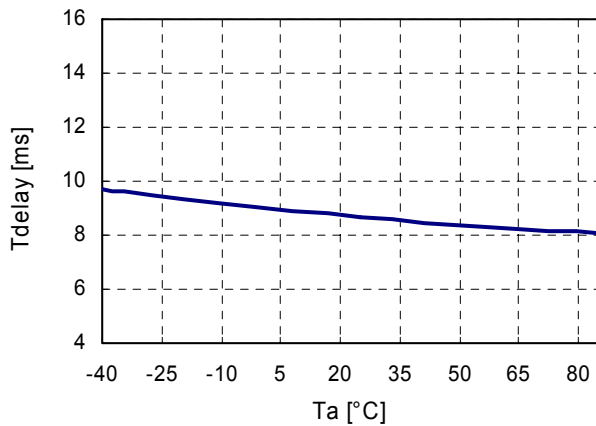

RP600K2xxC

V_{IN}=3.0V

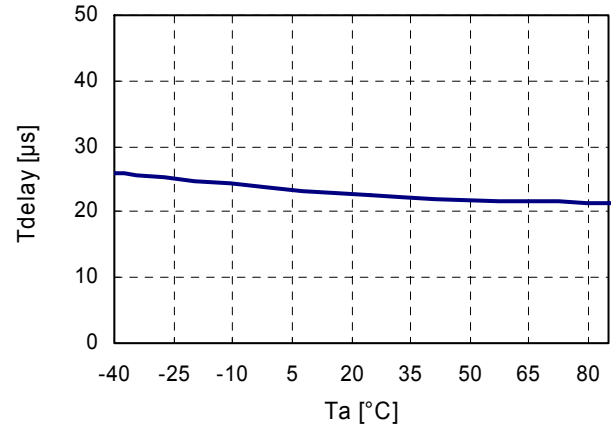

46) Voltage Detector Released Output Delay Time vs. Input Voltage

RP600KxxxxA/B/D

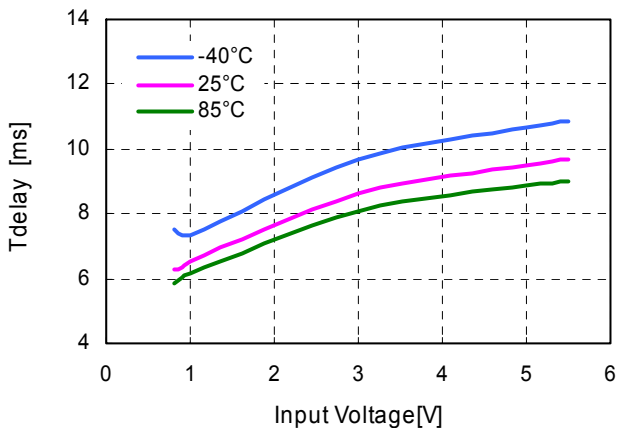

47) Turn On Speed with CE pin

RP600KxxxA/D

DC/DC=5.5V, LDO=5.0V, MODE="L", $V_{IN}=4.0V$,
 $I_{OUT1}=-500mA$, $I_{OUT2}=-50mA$, $T_a=25^{\circ}C$

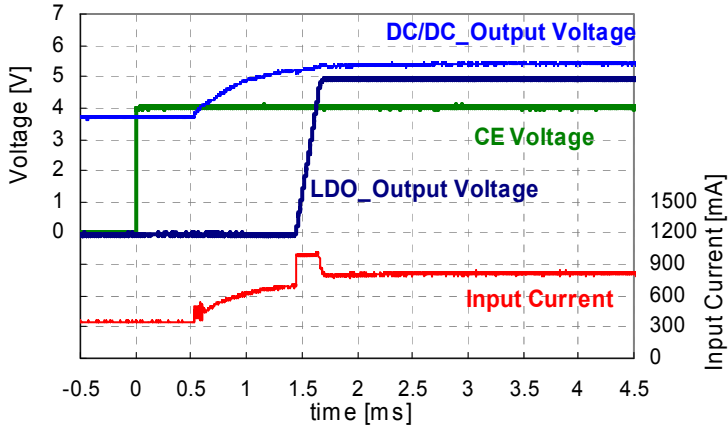

48) Turn On Speed with VDD

RP600K2xxC

DC/DC=5.5V, LDO=1.5V, $-V_{det}=2.8V$, HYS=80%, MODE="L",
 $V_{IN}=0V \rightarrow 2.5V$, $I_{OUT1}=0mA$, $I_{OUT2}=-1mA$, $T_a=25^{\circ}C$

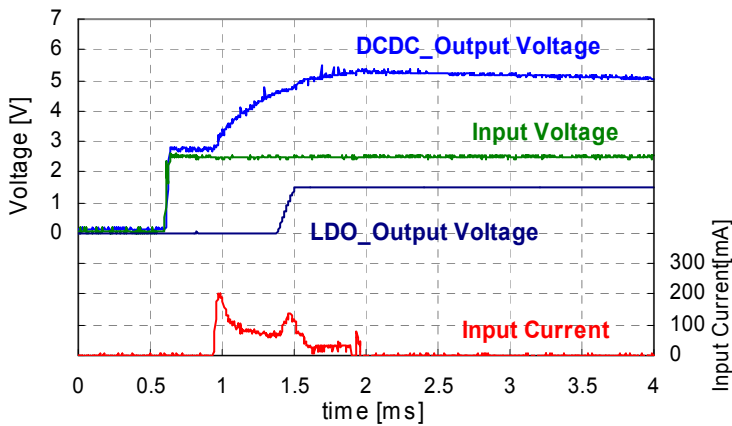

49) Turn On Speed with CE1, CE2

RP600K0xxB

DC/DC=5.5V, LDO=3.3V, MODE="L", $V_{IN}=4.0V$,
 $I_{OUT1}=-1000mA$, $I_{OUT2}=-0.1mA$, $T_a=25^{\circ}C$

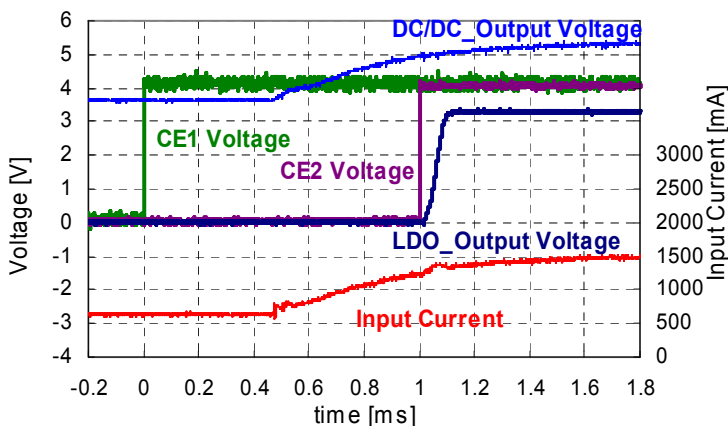

50) Turn On Speed with CE2, CE1

RP600K0xxB

DC/DC=5.5V, LDO=3.3V, MODE="L", $V_{IN}=4.0V$, $I_{OUT1}=-1000mA$, $I_{OUT2}=-0.1mA$, $T_a=25^{\circ}C$

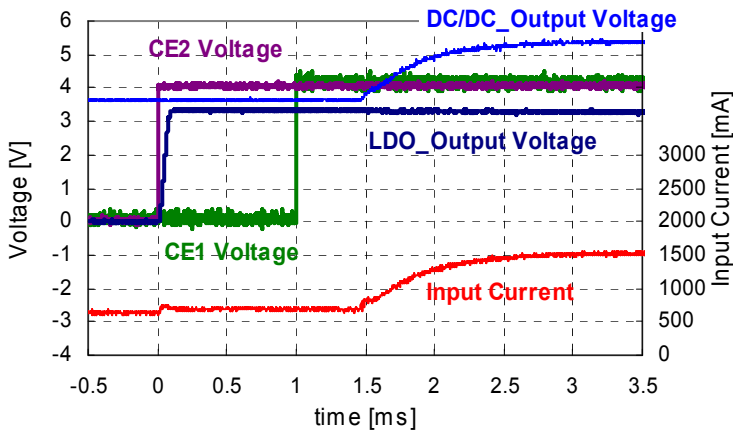

51) LDO Start-up Waveform (DC/DC=standby)

RP600KxxxB/C

LDO=3.3V, $V_{IN}=4.3V$, CE(CE1)=L,
 $I_{OUT2}=-1mA$, $T_a=25^{\circ}C$, MODE="L"

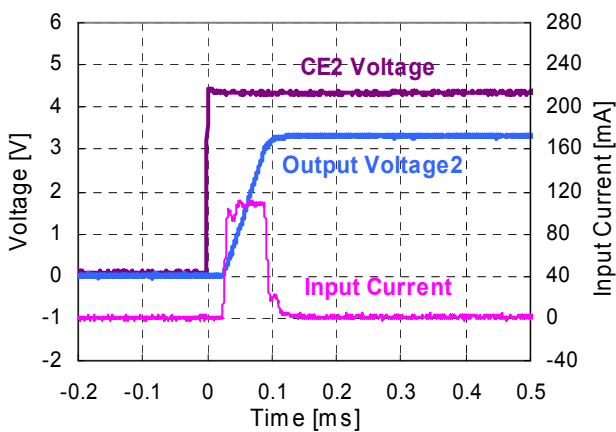

RP600KxxxB/C

LDO=3.3V, $V_{IN}=4.3V$, CE(CE1)=L,
 $I_{OUT2}=-1mA$, $T_a=25^{\circ}C$, MODE="H"

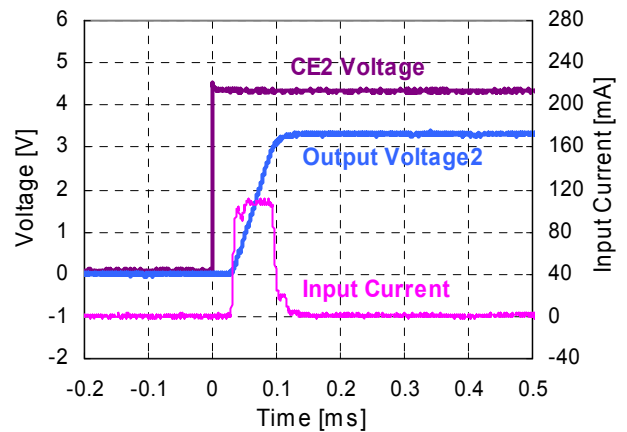

52) DC/DC Start-up Waveform (LDO=standby)

RP600K0xxB

DC/DC=3.3V, $V_{IN}=1.65V$, $I_{OUT1}=-1mA$, MODE="L", $T_a=25^{\circ}C$, CE2=0V

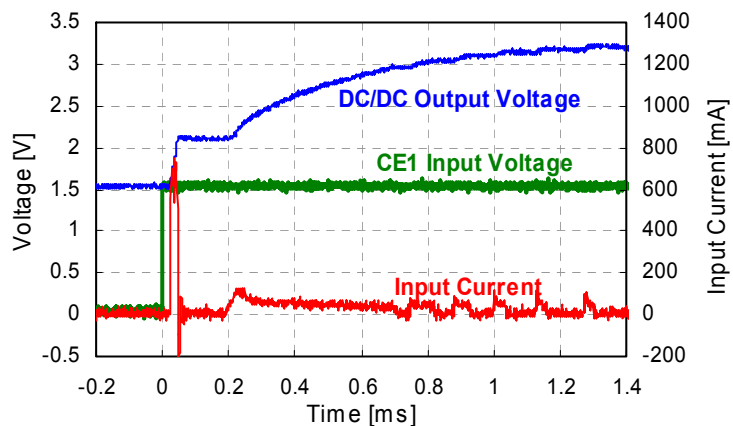

53) Turn Off Speed with CE

RP600KxxxA/D

DC/DC=5.5V, LDO=5.0V, MODE="L", $V_{IN}=4.0V$, $I_{OUT1}=-500mA$, $I_{OUT2}=-50mA$, $T_a=25^{\circ}C$

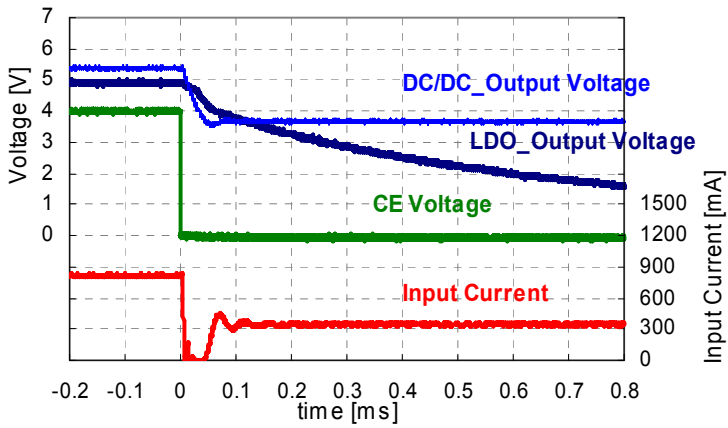

54) Turn Off Speed with CE1, CE2

RP600K0xxB

DC/DC=5.5V, LDO=3.3V, MODE="L", $V_{IN}=4.0V$, $I_{OUT1}=-1000mA$, $I_{OUT2}=-50mA$, $T_a=25^{\circ}C$

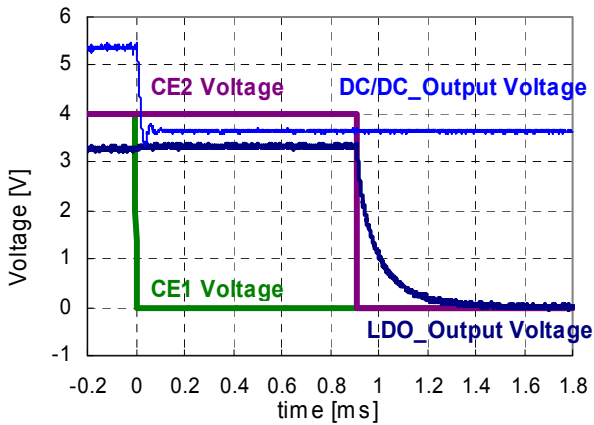

55) Turn Off Speed with CE2, CE1

RP600K0xxB

DC/DC=5.5V, LDO=3.3V, MODE="L", $V_{IN}=4.0V$, $I_{OUT1}=-1000mA$, $I_{OUT2}=-50mA$, $T_a=25^{\circ}C$

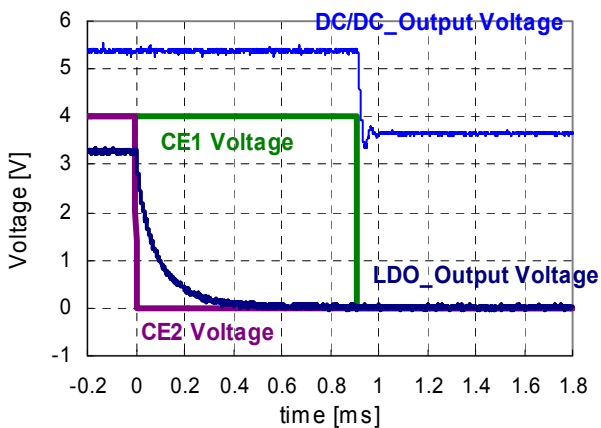

56) Output Voltage 1, Output Voltage 2, Lx Waveform

RP600KxxxA/B/D

DC/DC=5.5V, LDO=3.3V, $V_{IN}=4.0V$,

$I_{OUT1}=-0.1mA$, $I_{OUT2}=-0.1mA$, $T_a=25^{\circ}C$, MODE="L"

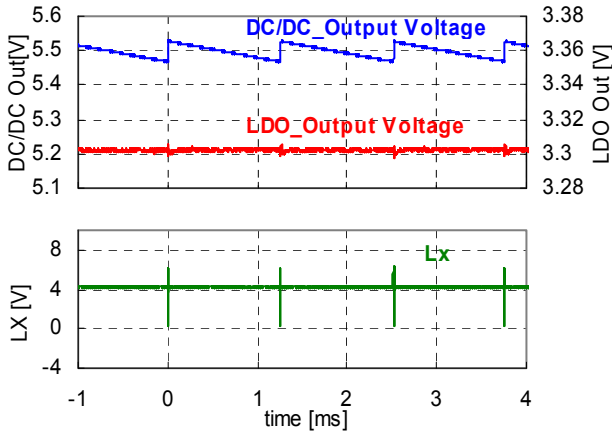

RP600KxxxA/B/D

DC/DC=5.5V, LDO=3.3V, $V_{IN}=4.0V$

$I_{OUT1}=-100mA$, $I_{OUT2}=-100mA$, $T_a=25^{\circ}C$, MODE="L"

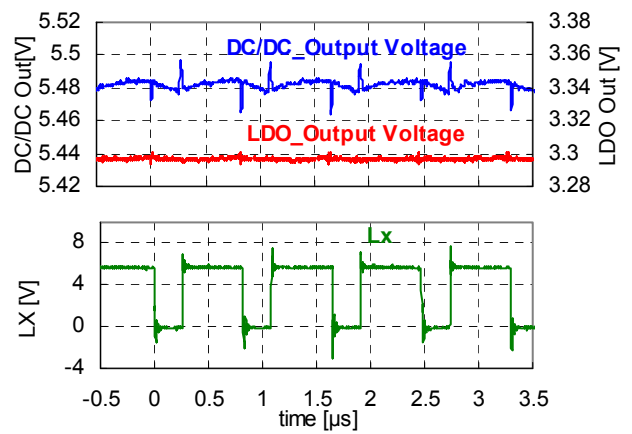

57) Output Voltage 1, Output Voltage 2, V_{DOUT} Waveform (RP600K2xxC)

DC/DC=5.5V, LDO=1.5V, $V_{IN}=1.0V$,

$I_{OUT1}=0mA$, $I_{OUT2}=-0.1mA$, $T_a=25^{\circ}C$, MODE="L"

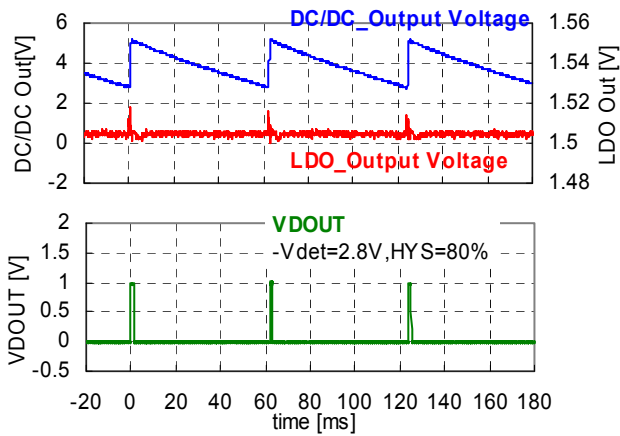

DC/DC=5.5V, LDO=1.5V, $V_{IN}=1.0V$

$I_{OUT1}=0mA$, $I_{OUT2}=-1mA$, $T_a=25^{\circ}C$, MODE="L"

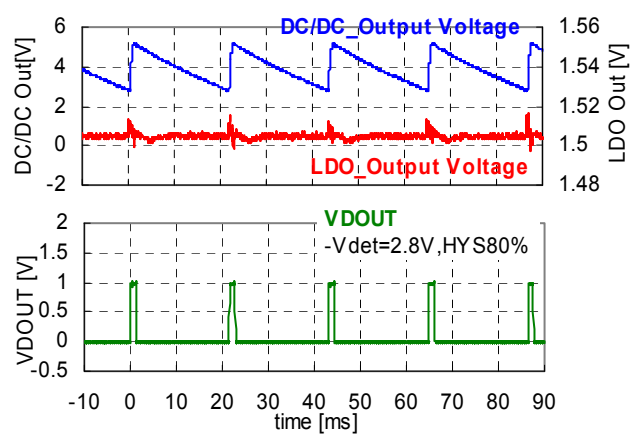

58) Input Transient Response_LDO (DC/DC=Standby)(RP600KxxxB/C)

LDO=3.3V, $I_{OUT2}=-0.5mA$, $CE(CE1)=L$,

$T_a=25^{\circ}C$, $V_{IN}=4.3V \sim 5.3V$, MODE="L"

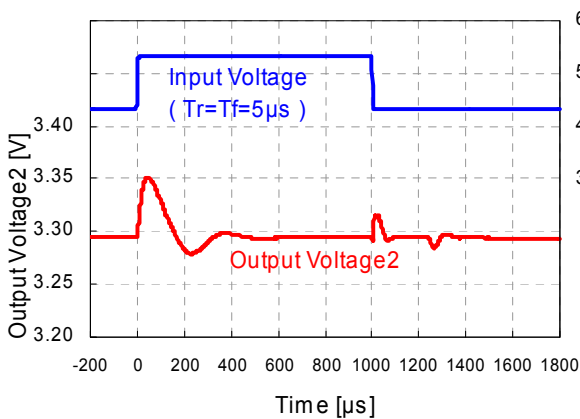

LDO=3.3V, $I_{OUT2}=-30mA$, $CE(CE1)=L$,

$T_a=25^{\circ}C$, $V_{IN}=4.3V \sim 5.3V$, MODE="H"

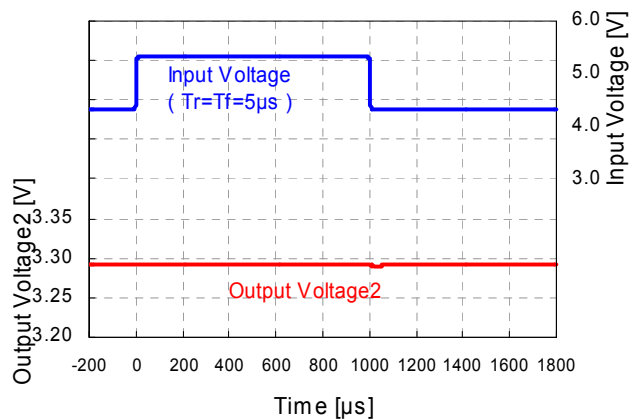

59) Load Transient Response (DC/DC&LDO)

RP600KxxxA/D
 DC/DC=5.5V, LDO=5.0V, $V_{IN}=4.0V$, MODE="L",
 DC/DC_ I_{OUT}=-0.1mA↔-500mA, LDO_ I_{OUT}=0mA↔-50mA, Ta=25°C,

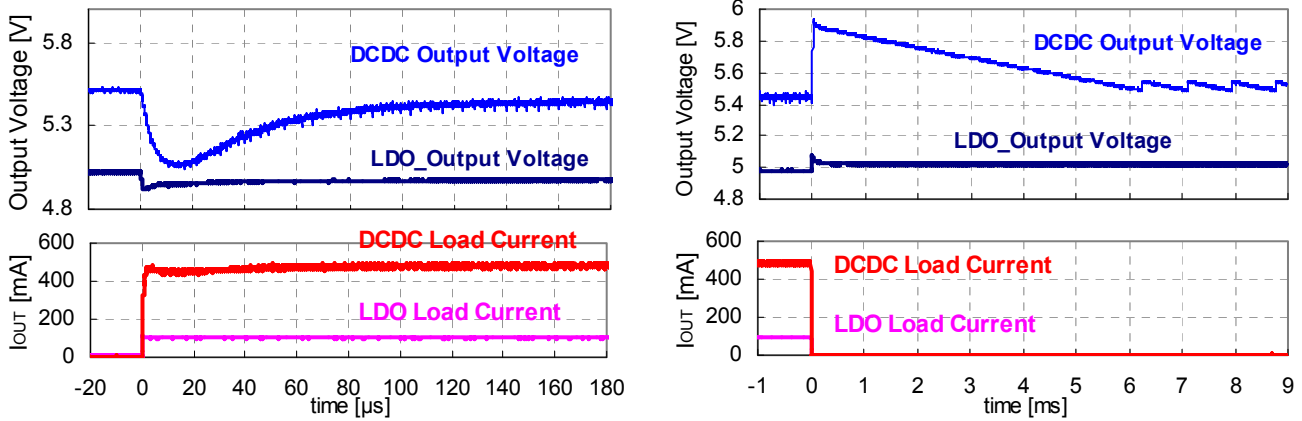

60) DC/DC Load Transient Response, LDO Output Voltage

RP600KxxxA/D
 DC/DC=5.5V, LDO=5.0V, $V_{IN}=4.0V$, MODE="L",
 DC/DC_ I_{OUT}=-0.1mA↔-500mA, LDO_ I_{OUT}=-100mA, Ta=25°C,

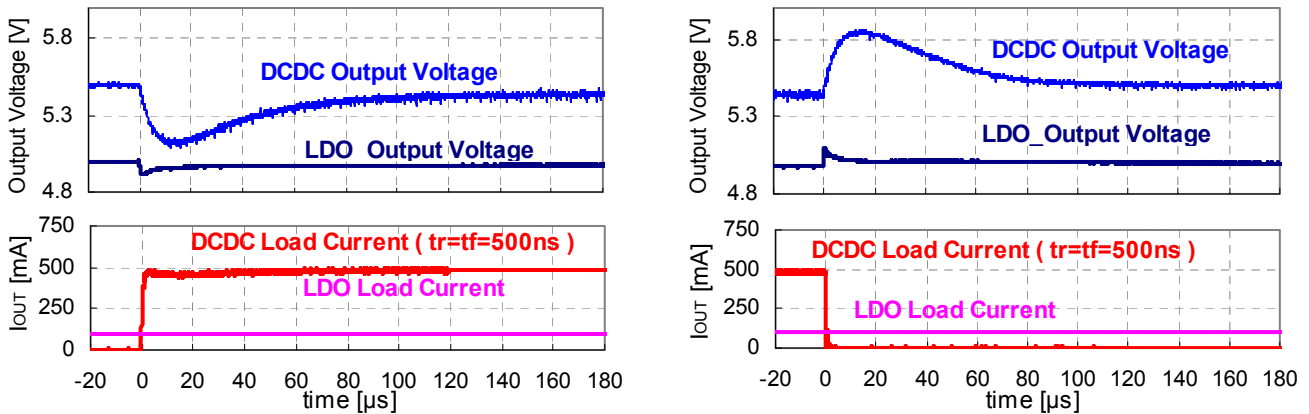

RP600K0xxB
 DC/DC=5.5V, LDO=3.3V, $V_{IN}=4.0V$, MODE="L",
 DC/DC_ I_{OUT}=-0.1mA↔-500mA, LDO_ I_{OUT}=-100mA, Ta=25°C,

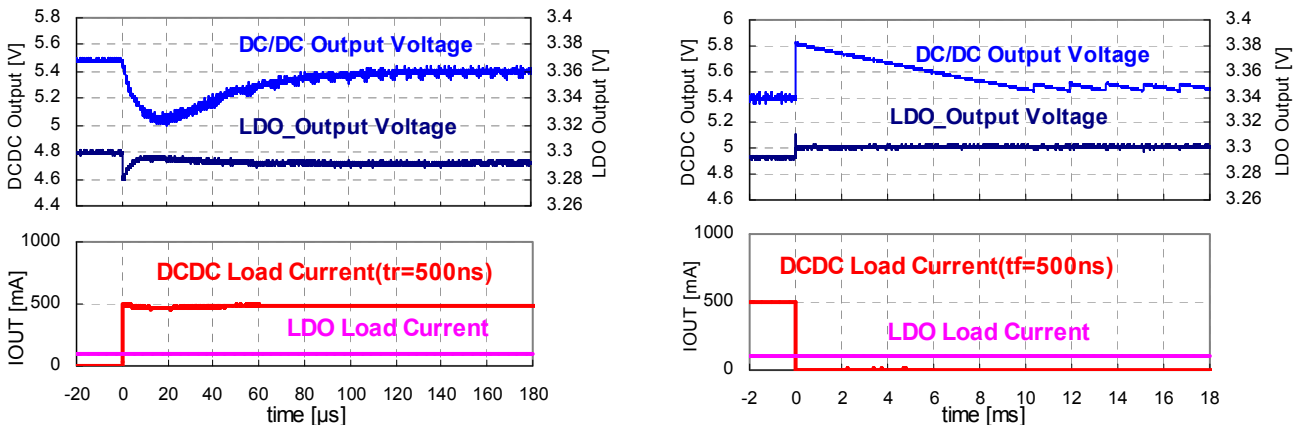

61) LDO Load Transient Response, DC/DC Output Voltage

RP600KxxxA/D

DC/DC=5.5V, LDO=5.0V, $V_{IN}=4.0V$, MODE="L",

DC/DC_ $I_{OUT}=-0.1mA$, LDO_ $I_{OUT}=0 \leftrightarrow -100mA$, $T_a=25^{\circ}C$,

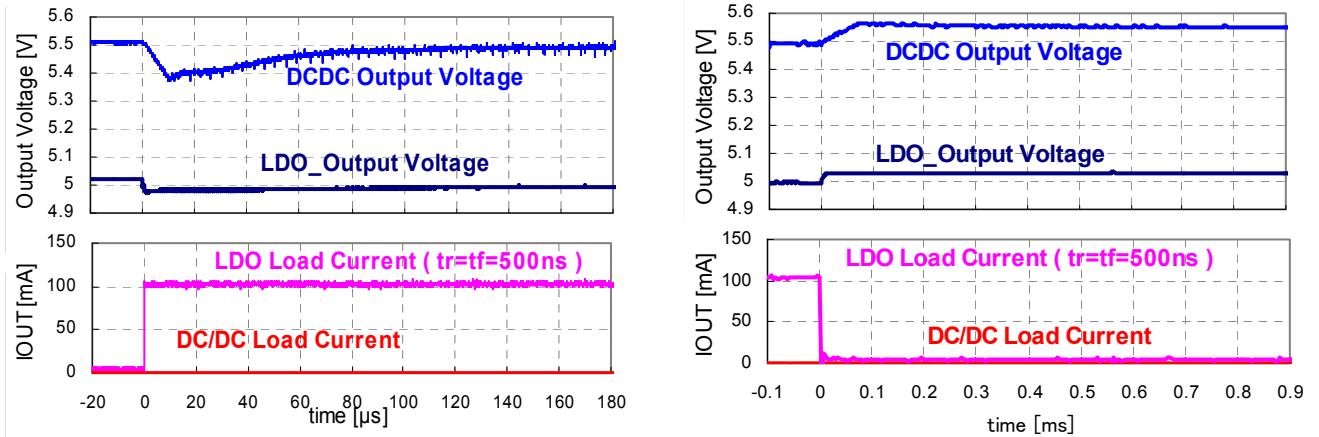

62) LDO Load Transient Response (DC/DC=Standby) (RP600K0xxB)

LDO=3.3V, $I_{OUT2}=-0.1mA \leftrightarrow -100mA$,

$V_{IN}=4.3V$, MODE="L", $CE1=0V$, $T_a=25^{\circ}C$

LDO=3.3V, $I_{OUT2}=-50mA \leftrightarrow -100mA$,

$V_{IN}=4.3V$, MODE="L", $CE1=0V$, $T_a=25^{\circ}C$

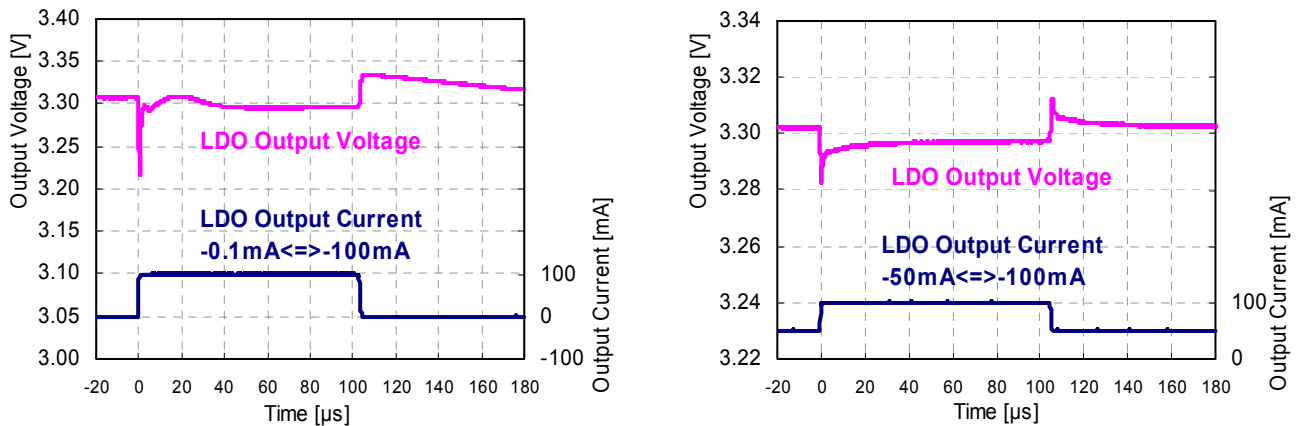

LDO=3.3V, $I_{OUT2}=-10mA \leftrightarrow -300mA$,

$V_{IN}=4.3V$, MODE="L", $CE1=0V$, $T_a=25^{\circ}C$

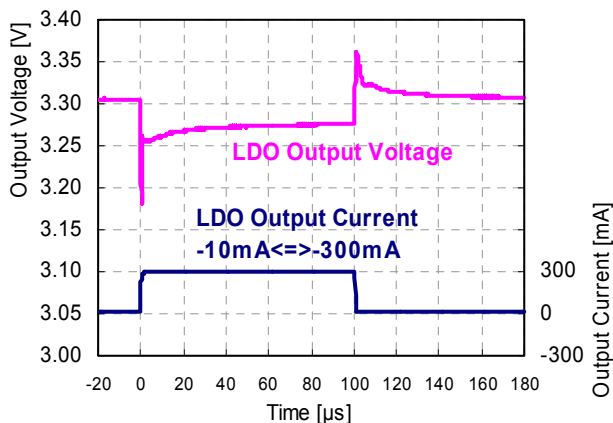

63) DC/DC Load Transient Response (LDO=Standby)

RP600K0xxB
 DC/DC=3.3V, $V_{IN}=1.65V$,
 MODE="L", CE2=L, $T_a=25^{\circ}C$

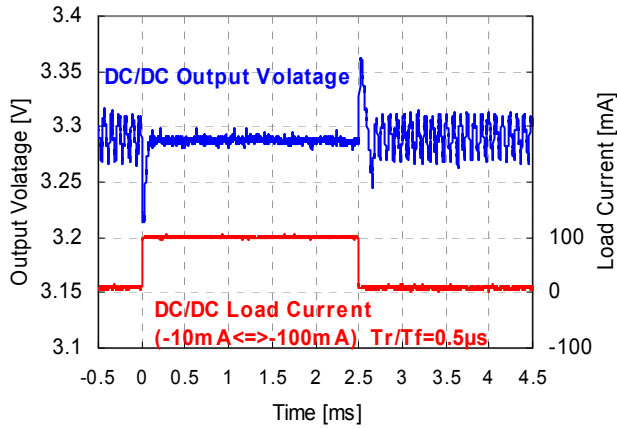

RP600K0xxB
 DC/DC=3.3V, $V_{IN}=1.65V$,
 MODE="L", CE2=L, $T_a=25^{\circ}C$

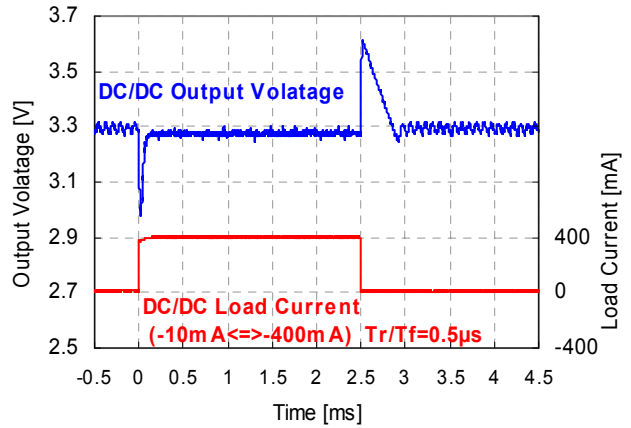

64) MODE pin Switching Response (DC/DC&LDO)

RP600KxxxA/D
 DC/DC=5.5V, LDO=5.0V, $V_{IN}=4.0V$, DC/DC $I_{OUT}=-0.1mA$, LDO $I_{OUT}=-20mA$, $T_a=25^{\circ}C$

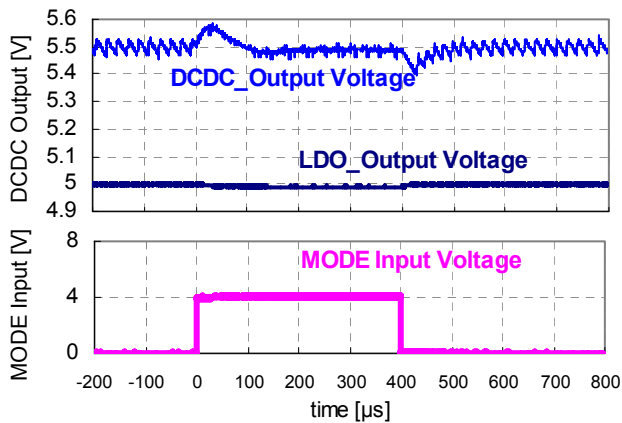

65) MODE pin Switching Response (LDO)

RP600KxxxB/C
 (DC/DC=Standby), LDO=3.3V,
 $I_{OUT2}=-2.5mA$, $V_{IN}=4.3V$, CE(CE1)=0V, $T_a=25^{\circ}C$

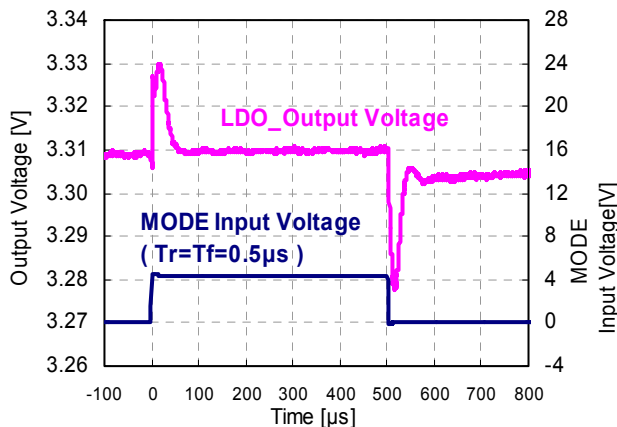

66) MODE pin Switching Response (DC/DC)

RP600K0xxB
 (LDO=Standby), DC/DC=3.3V,
 $V_{IN}=1.5V$, $I_{OUT1}=-0.1mA$, CE2=L, $T_a=25^{\circ}C$

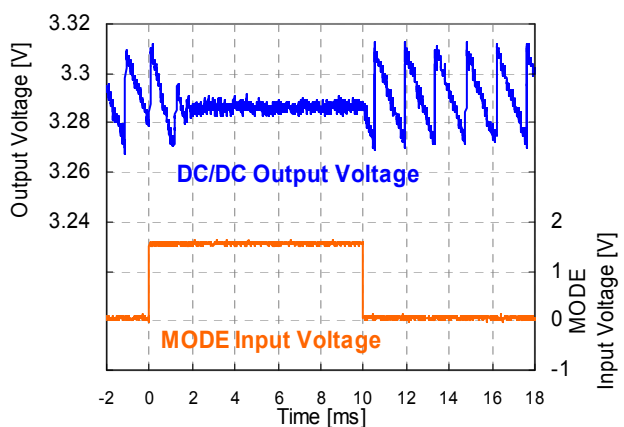



1. The products and the product specifications described in this document are subject to change or discontinuation of production without notice for reasons such as improvement. Therefore, before deciding to use the products, please refer to Ricoh sales representatives for the latest information thereon.
2. The materials in this document may not be copied or otherwise reproduced in whole or in part without prior written consent of Ricoh.
3. Please be sure to take any necessary formalities under relevant laws or regulations before exporting or otherwise taking out of your country the products or the technical information described herein.
4. The technical information described in this document shows typical characteristics of and example application circuits for the products. The release of such information is not to be construed as a warranty of or a grant of license under Ricoh's or any third party's intellectual property rights or any other rights.
5. The products listed in this document are intended and designed for use as general electronic components in standard applications (office equipment, telecommunication equipment, measuring instruments, consumer electronic products, amusement equipment etc.). Those customers intending to use a product in an application requiring extreme quality and reliability, for example, in a highly specific application where the failure or misoperation of the product could result in human injury or death (aircraft, spacevehicle, nuclear reactor control system, traffic control system, automotive and transportation equipment, combustion equipment, safety devices, life support system etc.) should first contact us.
6. We are making our continuous effort to improve the quality and reliability of our products, but semiconductor products are likely to fail with certain probability. In order to prevent any injury to persons or damages to property resulting from such failure, customers should be careful enough to incorporate safety measures in their design, such as redundancy feature, fire containment feature and fail-safe feature. We do not assume any liability or responsibility for any loss or damage arising from misuse or inappropriate use of the products.
7. Anti-radiation design is not implemented in the products described in this document.
8. Please contact Ricoh sales representatives should you have any questions or comments concerning the products or the technical information.



Ricoh is committed to reducing the environmental loading materials in electrical devices with a view to contributing to the protection of human health and the environment.

Ricoh has been providing RoHS compliant products since April 1, 2006 and Halogen-free products since April 1, 2012.

RICOH RICOH ELECTRONIC DEVICES CO., LTD.

<http://www.e-devices.ricoh.co.jp/en/>

Sales & Support Offices

RICOH ELECTRONIC DEVICES CO., LTD.

Higashi-Shinagawa Office (International Sales)
3-32-3, Higashi-Shinagawa, Shinagawa-ku, Tokyo 140-8655, Japan
Phone: +81-3-5479-2857 Fax: +81-3-5479-0502

RICOH EUROPE (NETHERLANDS) B.V.

Semiconductor Support Centre
Prof. W.H. Keesomlaan 1, 1183 DJ Amstelveen, The Netherlands
Phone: +31-20-5474-309

RICOH INTERNATIONAL B.V. - German Branch

Semiconductor Sales and Support Centre
Oberrather Strasse 6, 40472 Düsseldorf, Germany
Phone: +49-211-6546-0

RICOH ELECTRONIC DEVICES KOREA CO., LTD.

3F, Haesung Bldg, 504, Teheran-ro, Gangnam-gu, Seoul, 135-725, Korea
Phone: +82-2-2135-5700 Fax: +82-2-2051-5713

RICOH ELECTRONIC DEVICES SHANGHAI CO., LTD.

Room 403, No.2 Building, No.690 Bibo Road, Pu Dong New District, Shanghai 201203, People's Republic of China
Phone: +86-21-5027-3200 Fax: +86-21-5027-3299

RICOH ELECTRONIC DEVICES CO., LTD.

Taipei office
Room 109, 10F-1, No.51, Hengyang Rd., Taipei City, Taiwan (R.O.C.)
Phone: +886-2-2313-1621/1622 Fax: +886-2-2313-1623

Mouser Electronics

Authorized Distributor

Click to View Pricing, Inventory, Delivery & Lifecycle Information:

[Ricoch Electronics:](#)

[RP600K104D-TR](#)



Компания «ЭлектроПласт» предлагает заключение долгосрочных отношений при поставках импортных электронных компонентов на взаимовыгодных условиях!

Наши преимущества:

- Оперативные поставки широкого спектра электронных компонентов отечественного и импортного производства напрямую от производителей и с крупнейших мировых складов;
- Поставка более 17-ти миллионов наименований электронных компонентов;
- Поставка сложных, дефицитных, либо снятых с производства позиций;
- Оперативные сроки поставки под заказ (от 5 рабочих дней);
- Экспресс доставка в любую точку России;
- Техническая поддержка проекта, помощь в подборе аналогов, поставка прототипов;
- Система менеджмента качества сертифицирована по Международному стандарту ISO 9001;
- Лицензия ФСБ на осуществление работ с использованием сведений, составляющих государственную тайну;
- Поставка специализированных компонентов (Xilinx, Altera, Analog Devices, Intersil, Interpoint, Microsemi, Aeroflex, Peregrine, Syfer, Eurofarad, Texas Instrument, Miteq, Cobham, E2V, MA-COM, Hittite, Mini-Circuits, General Dynamics и др.);

Помимо этого, одним из направлений компании «ЭлектроПласт» является направление «Источники питания». Мы предлагаем Вам помощь Конструкторского отдела:

- Подбор оптимального решения, техническое обоснование при выборе компонента;
- Подбор аналогов;
- Консультации по применению компонента;
- Поставка образцов и прототипов;
- Техническая поддержка проекта;
- Защита от снятия компонента с производства.



Как с нами связаться

Телефон: 8 (812) 309 58 32 (многоканальный)

Факс: 8 (812) 320-02-42

Электронная почта: org@eplast1.ru

Адрес: 198099, г. Санкт-Петербург, ул. Калинина, дом 2, корпус 4, литера А.