

# Standalone 750mA Li-Ion Battery Charger in 2 × 2 DFN

## FEATURES

- Complete Linear Charger in 2mm × 2mm DFN Package
- C/10 Charge Current Detection Output
- Timer Termination
- Charge Current Programmable up to 750mA with 5% Accuracy
- No External MOSFET, Sense Resistor or Blocking Diode Required
- Preset 4.2V Float Voltage with 0.6% Accuracy
- Constant-Current/Constant-Voltage Operation with Thermal Feedback to Maximize Charging Rate Without Risk of Overheating
- ACPR Pin Indicates Presence of Input Supply (LTC4065A Only)
- Charge Current Monitor Output for Gas Gauging
- Automatic Recharge
- Charges Single Cell Li-Ion Batteries Directly from USB Port
- 20 $\mu$ A Supply Current in Shutdown Mode
- Soft-Start Limits Inrush Current
- Tiny 6-Lead (2mm × 2mm) DFN Package

## APPLICATIONS

- Wireless PDAs
- Cellular Phones
- Portable Electronics

LT, LT, LTC and LTM are registered trademarks of Linear Technology Corporation. All other trademarks are the property of their respective owners.

## DESCRIPTION

The LTC<sup>®</sup>4065 is a complete constant-current/constant-voltage linear charger for single-cell lithium-ion batteries. Its 2mm × 2mm DFN package and low external component count make the LTC4065 especially well-suited for portable applications. Furthermore, LTC4065 is specifically designed to work within USB power specifications.

The  $\overline{\text{CHRG}}$  pin indicates when charge current has dropped to ten percent of its programmed value (C/10). An internal timer terminates charging according to battery manufacturer specifications.

No external sense resistor or blocking diode is required due to the internal MOSFET architecture. Thermal feedback regulates charge current to limit the die temperature during high power operation or high ambient temperature conditions.

When the input supply (wall adapter or USB supply) is removed, the LTC4065 automatically enters a low current state, dropping battery drain current to less than 1 $\mu$ A. With power applied, LTC4065 can be put into shutdown mode, reducing the supply current to less than 20 $\mu$ A.

The full-featured LTC4065 also includes automatic recharge, low-battery charge conditioning (trickle charging), soft-start (to limit inrush current) and an open-drain status pin to indicate the presence of an adequate input voltage (LTC4065A only).

The LTC4065 is available in a tiny 6-lead, low profile (0.75mm) 2mm × 2mm DFN package.

## TYPICAL APPLICATION

Standalone Li-Ion Battery Charger

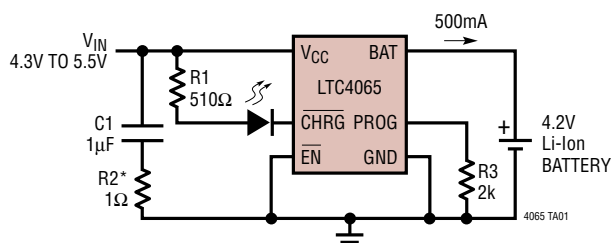

\*SERIES 1 $\Omega$  RESISTOR ONLY NEEDED FOR INDUCTIVE INPUT SUPPLIES



4065fb

## ABSOLUTE MAXIMUM RATINGS

(Note 1)

$V_{CC}$	$t < 1\text{ms}$ and Duty Cycle $< 1\%$ .....	-0.3V to 7V
	Steady State .....	-0.3V to 6V
BAT, CHRG	.....	-0.3V to 6V
EN (LTC4065), ACPR (LTC4065A) ..		-0.3V to $V_{CC} + 0.3\text{V}$
PROG .....		-0.3V to $V_{CC} + 0.3\text{V}$
BAT Short-Circuit Duration .....		Continuous
BAT Pin Current .....		800mA
PROG Pin Current .....		800 $\mu\text{A}$
Junction Temperature (Note 6) .....		125°C
Operating Temperature Range (Note 2) ..		-40°C to 85°C
Storage Temperature Range .....		-65°C to 125°C

## PACKAGE/ORDER INFORMATION

TOP VIEW

DC PACKAGE  
6-LEAD (2mm x 2mm) PLASTIC DFN  
 $T_{JMAX} = 125^\circ\text{C}$ ,  $\theta_{JA} = 60^\circ\text{C/W}$  (NOTE 3)  
EXPOSED PAD (PIN 7) IS GND, MUST BE SOLDERED TO PCB  
\*EN PIN 5 ON LTC4065EDC, ACPR PIN 5 ON LTC4065AEDC

ORDER PART NUMBER	DC PART MARKING
LTC4065EDC	LBPB
LTC4065AEDC	LBVJ

**Order Options** Tape and Reel: Add #TR  
Lead Free: Add #PBF Lead Free Tape and Reel: Add #TRPBF  
Lead Free Part Marking: <http://www.linear.com/leadfree/>

Consult LTC Marketing for parts specified with wider operating temperature ranges.

## ELECTRICAL CHARACTERISTICS

The ● denotes specifications which apply over the full operating temperature range, otherwise specifications are  $T_A = 25^\circ\text{C}$ .  
 $V_{CC} = 5\text{V}$ ,  $V_{BAT} = 3.8\text{V}$ ,  $V_{EN} = 0\text{V}$  (LTC4065 only) unless otherwise specified. (Note 2)

SYMBOL	PARAMETER	CONDITIONS	MIN	TYP	MAX	UNITS	
$V_{CC}$	$V_{CC}$ Supply Voltage	(Note 4)	● 3.75		5.5	V	
$I_{CC}$	Quiescent $V_{CC}$ Supply Current	$V_{BAT} = 4.5\text{V}$ (Forces $I_{BAT}$ and $I_{PROG} = 0$ )	●	120	250	$\mu\text{A}$	
$I_{CCMS}$	$V_{CC}$ Supply Current in Shutdown	$V_{EN} = 5\text{V}$ (LTC4065) or Float PROG (LTC4065A)	●	20	40	$\mu\text{A}$	
$I_{CCUV}$	$V_{CC}$ Supply Current in Undervoltage Lockout	$V_{CC} < V_{BAT}$ , $V_{CC} = 3.5\text{V}$ , $V_{BAT} = 4\text{V}$	●	6	11	$\mu\text{A}$	
$V_{FLOAT}$	$V_{BAT}$ Regulated Output Voltage	$I_{BAT} = 2\text{mA}$ $I_{BAT} = 2\text{mA}$ , $0^\circ\text{C} < T_A < 85^\circ\text{C}$		4.175 4.158	4.2 4.242	V V	
$I_{BAT}$	BAT Pin Current	$R_{PROG} = 10\text{k}$ (0.1%), Current Mode	● 88	100	112	mA	
		$R_{PROG} = 2\text{k}$ (0.1%), Current Mode	● 475	500	525	mA	
$I_{BMS}$	Battery Drain Current in Shutdown Mode	$V_{EN} = V_{CC}$ (LTC4065), $V_{PROG} > V_{MS,PROG}$ (LTC4065A)	● -1	0	1	$\mu\text{A}$	
$I_{BUV}$	Battery Drain Current in Undervoltage Lockout	$V_{CC} = 3.5\text{V}$ , $V_{BAT} = 4\text{V}$	● 0	1	4	$\mu\text{A}$	
$V_{UVLO}$	$V_{CC}$ Undervoltage Lockout Voltage	$V_{CC}$ Rising	● 3.4	3.6	3.8	V	
		$V_{CC}$ Falling	● 2.8	3.0	3.2	V	
$V_{PROG}$	PROG Pin Voltage	$R_{PROG} = 2\text{k}$ , $I_{PROG} = 500\mu\text{A}$	● 0.98	1	1.02	V	
		$R_{PROG} = 10\text{k}$ , $I_{PROG} = 100\mu\text{A}$	● 0.98	1	1.02	V	
$V_{ASD}$	Automatic Shutdown Threshold Voltage	$(V_{CC} - V_{BAT})$ , $V_{CC}$ Low to High		60	82	100	mV
		$(V_{CC} - V_{BAT})$ , $V_{CC}$ High to Low		15	32	45	mV
$V_{MSH}$	Manual Shutdown High Voltage (LTC4065)	$V_{EN}$ Rising			1	V	
$V_{MSL}$	Manual Shutdown Low Voltage (LTC4065)	$V_{EN}$ Falling		0.6		V	
$R_{EN}$	EN Pin Input Resistance		● 0.95	1.5	3.3	$\text{M}\Omega$	

4065fb

## ELECTRICAL CHARACTERISTICS

The ● denotes specifications which apply over the full operating temperature range, otherwise specifications are  $T_A = 25^\circ\text{C}$ .  
 $V_{CC} = 5\text{V}$ ,  $V_{BAT} = 3.8\text{V}$ ,  $V_{EN} = 0\text{V}$  (LTC4065 only) unless otherwise specified. (Note 2)

SYMBOL	PARAMETER	CONDITIONS	MIN	TYP	MAX	UNITS	
$I_{PROG}$	PROG Pin Pull-Up Current (LTC4065A)	$V_{PROG} > 1\text{V}$		3		$\mu\text{A}$	
$V_{MS,PROG}$	PROG Shutdown Threshold Voltage (LTC4065A Only)	$V_{PROG}$ Rising	● 3.7	4	4.3	V	
$t_{SS}$	Soft-Start Time			180		$\mu\text{s}$	
$I_{TRKL}$	Trickle Charge Current	$V_{BAT} = 2\text{V}$ , $R_{PROG} = 2\text{k}$ (0.1%)		35	50	65	mA
$V_{TRKL}$	Trickle Charge Threshold Voltage	$V_{BAT}$ Rising	● 2.7	2.9	3.05	V	
$V_{TRHYS}$	Trickle Charge Hysteresis Voltage			90		mV	
$\Delta V_{RECHRG}$	Recharge Battery Threshold Voltage	$V_{FLOAT} - V_{RECHRG}$ , $0^\circ\text{C} < T_A < 85^\circ\text{C}$		70	100	130	mV
$\Delta V_{UVCL1}$	$(V_{CC} - V_{BAT})$ Undervoltage Current Limit	$I_{BAT} = 90\%$ Programmed Charge Current		180	220	330	mV
$\Delta V_{UVCL2}$		$I_{BAT} = 10\%$ Programmed Charge Current		90	125	150	mV
$t_{TIMER}$	Termination Timer		● 3	4.5	6	Hrs	
	Recharge Time		● 1.5	2.25	3	Hrs	
	Low-Battery Trickle Charge Time	$V_{BAT} = 2.5\text{V}$	● 0.75	1.125	1.5	Hrs	
$V_{ACPR}$	ACPR Pin Output Low Voltage (LTC4065A)	$I_{ACPR} = 5\text{mA}$	●	60	105	mV	
$I_{ACPR}$	ACPR Pin Input Current (LTC4065A)	$V_{CC} = 4\text{V}$ , $V_{ACPR} = 4\text{V}$ , $V_{BAT} = 4.5\text{V}$	●	0	1	$\mu\text{A}$	
$V_{CHRG}$	CHRG Pin Output Low Voltage	$I_{CHRG} = 5\text{mA}$	●	60	105	mV	
$I_{CHRG}$	CHRG Pin Input Current	$V_{BAT} = 4.5\text{V}$ , $V_{CHRG} = 5\text{V}$	●	0	1	$\mu\text{A}$	
$I_{C/10}$	End of Charge Indication Current Level	$R_{PROG} = 2\text{k}$ (Note 5)	● 0.085	0.1	0.115	mA/mA	
$T_{LIM}$	Junction Temperature in Constant Temperature Mode			115		$^\circ\text{C}$	
$R_{ON}$	Power FET "ON" Resistance (Between $V_{CC}$ and BAT)	$I_{BAT} = 200\text{mA}$		450		$\text{m}\Omega$	
$f_{BADBAT}$	Defective Battery Detection CHRG Pulse Frequency			2		Hz	
$D_{BADBAT}$	Defective Battery Detection CHRG Pulse Frequency Duty Ratio			75		%	

**Note 1:** Stresses beyond those listed under Absolute Maximum Ratings may cause permanent damage to the device. Exposure to any Absolute Maximum Rating condition for extended periods may affect device reliability and lifetime.

**Note 2:** The LTC4065/LTC4065A are guaranteed to meet performance specifications from  $0^\circ\text{C}$  to  $70^\circ\text{C}$ . Specifications over the  $-40^\circ\text{C}$  to  $85^\circ\text{C}$  operating temperature range are assured by design, characterization and correlation with statistical process controls.

**Note 3:** Failure to solder the exposed backside of the package to the PC board ground plane will result in a thermal resistance much higher than rated.

**Note 4:** Although the LTC4065 functions properly at  $3.75\text{V}$ , full charge current requires an input voltage greater than the desired final battery voltage per the  $\Delta V_{UVCL1}$  specification.

**Note 5:**  $I_{C/10}$  is expressed as a fraction of measured full charge current with indicated PROG resistor.

**Note 6:** This IC includes overtemperature protection that is intended to protect the device during momentary overload conditions. Junction temperature will exceed  $125^\circ\text{C}$  when overtemperature protection is active. Continuous operation above the specified maximum operating junction temperature may impair device reliability.

## TYPICAL PERFORMANCE CHARACTERISTICS

**Battery Regulation (Float) Voltage vs Battery Charge Current**

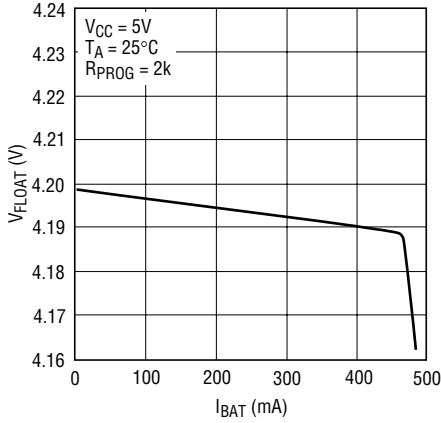

**Battery Regulation (Float) Voltage vs Temperature**

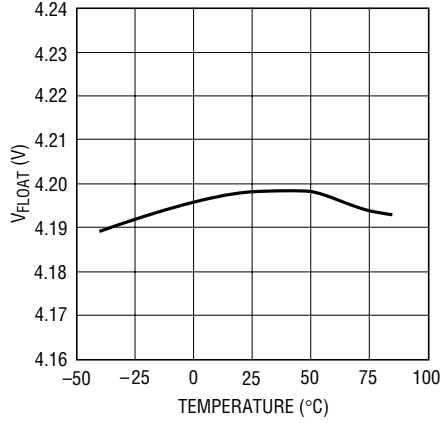

**Regulated Output (Float) Voltage vs Supply Voltage**

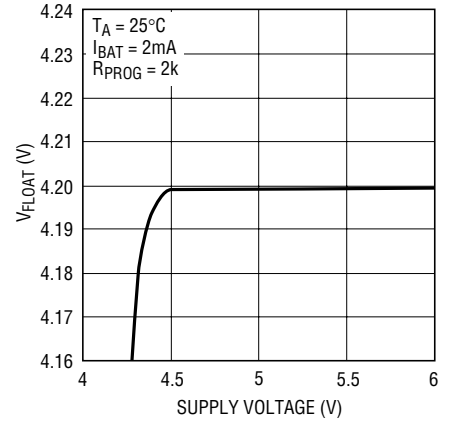

**Charge Current vs Supply Voltage (Constant Current Mode)**

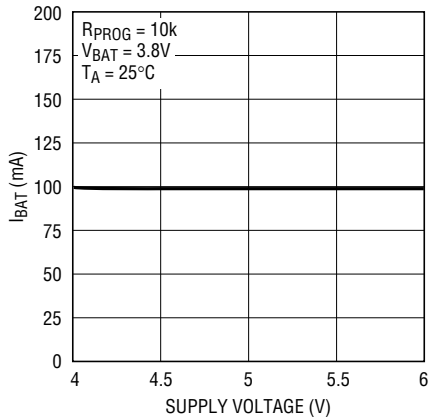

**Charge Current vs Battery Voltage**

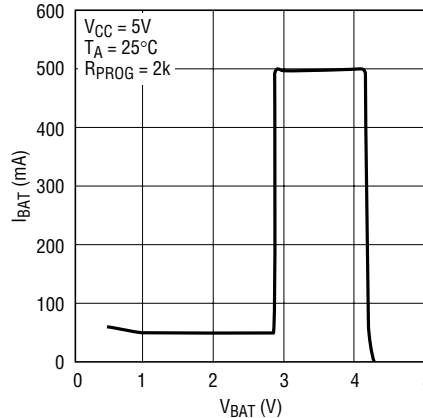

**Charge Current vs Temperature with Thermal Regulation (Constant Current Mode)**

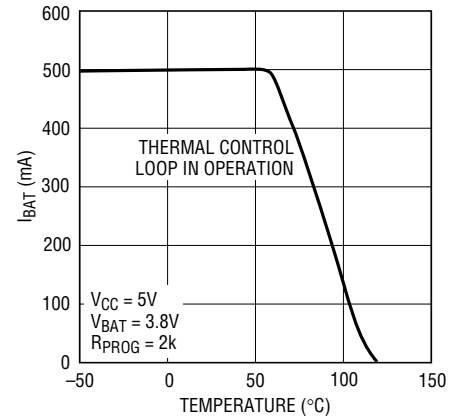

**PROG Pin Voltage vs Temperature (Constant Current Mode)**

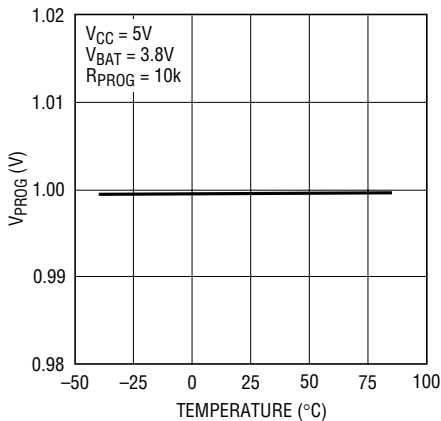

**PROG Pin Voltage vs Charge Current**

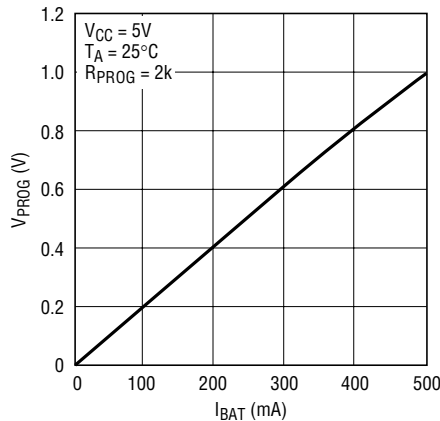

**Power FET On Resistance vs Temperature**

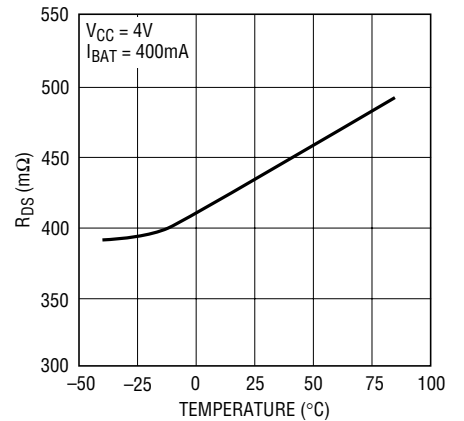

# TYPICAL PERFORMANCE CHARACTERISTICS

**Undervoltage Lockout Threshold Voltage vs Temperature**

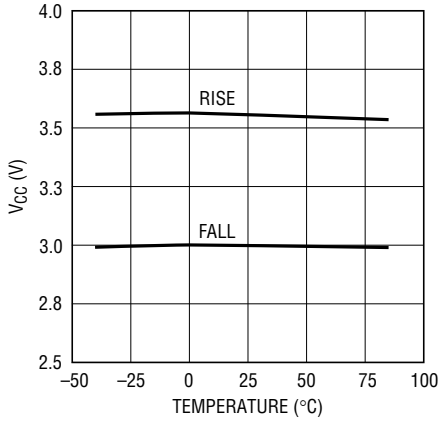

4065 G16

**Manual Shutdown Threshold Voltage vs Temperature (LTC4065)**

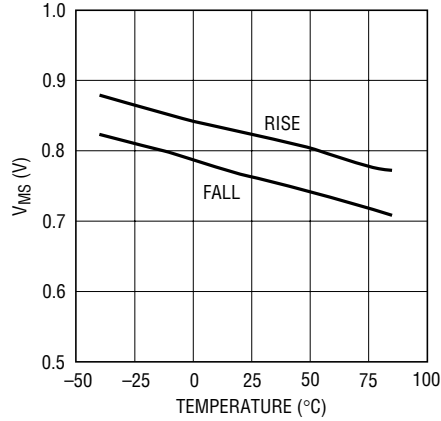

4065 G11

**Manual Shutdown Supply Current vs Temperature**

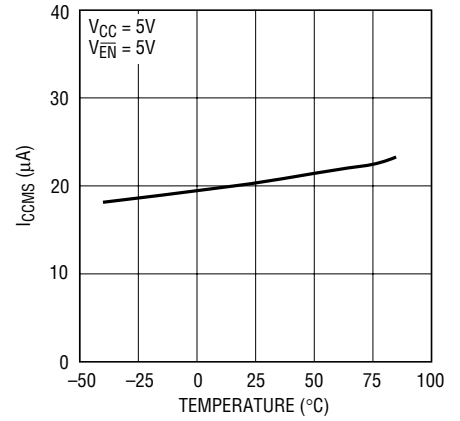

4065 G12

**EN Pin Current (LTC4065)**

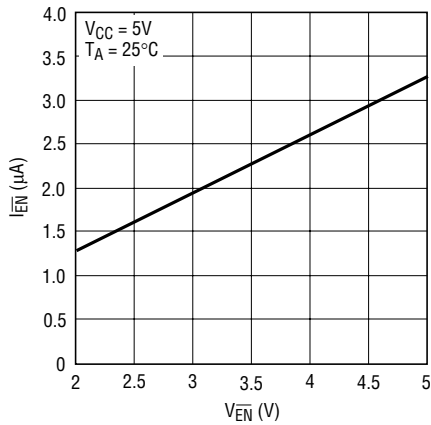

4065 G13

**Trickle Charge Current vs Supply Voltage**

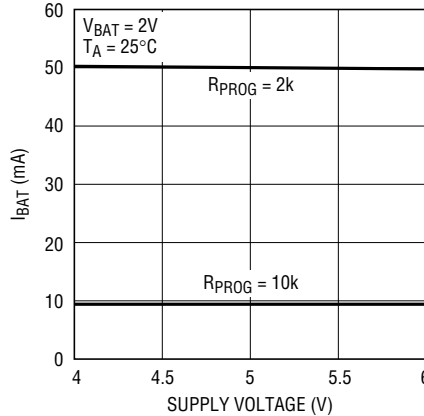

4065 G14

**Trickle Charge Current vs Temperature**

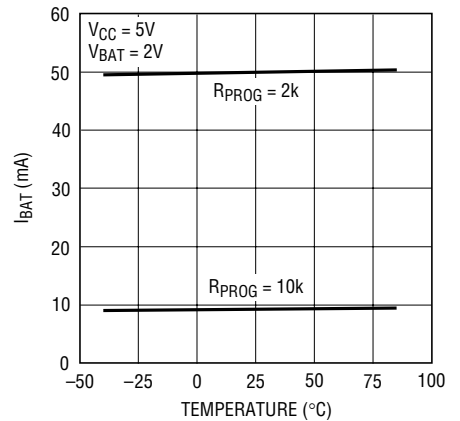

4065 G15

**CHRG Pin Output Low Voltage vs Temperature**

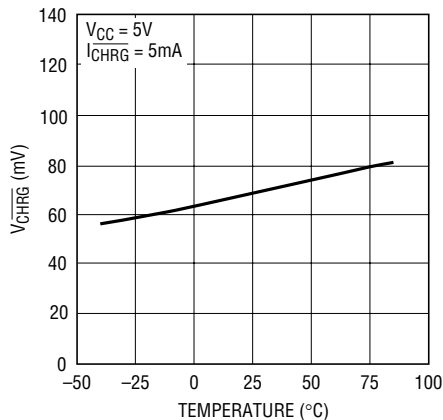

4065 G10

**ACPR Pin Output Low Voltage vs Temperature (LTC4065A Only)**

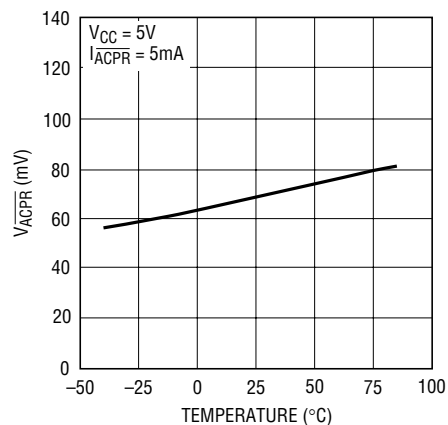

4065 G17

**TYPICAL PERFORMANCE CHARACTERISTICS**

**Timer Accuracy vs Temperature**

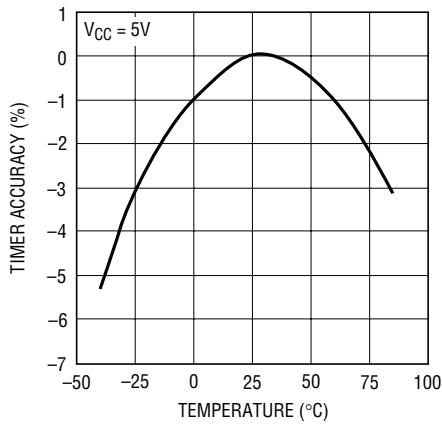

4065 G18

**Timer Accuracy vs Supply Voltage**

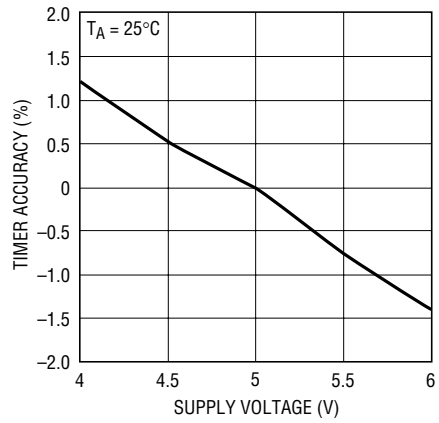

4065 G19

**PROG Pin Shutdown Threshold vs Temperature (LTC4065A Only)**

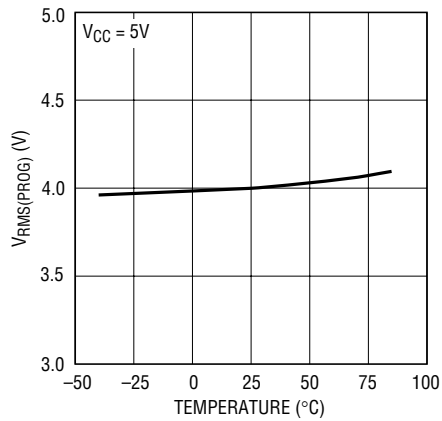

4065 G20

**PROG Pin Shutdown Voltage vs Supply Voltage (LTC4065A Only)**

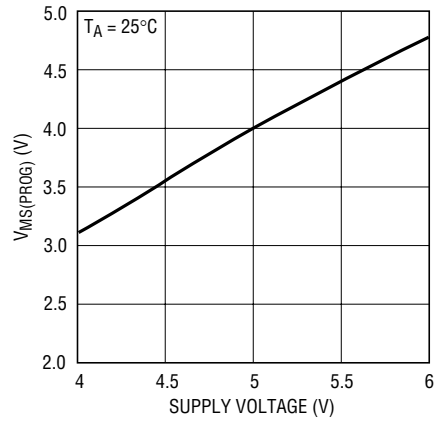

4065 G21

## PIN FUNCTIONS

**GND (Pin 1):** Ground.

**CHRG (Pin 2):** Open-Drain Charge Status Output. The charge status indicator pin has three states: pull-down, pulse at 2Hz and high impedance state. This output can be used as a logic interface or as an LED driver. When the battery is being charged, the  $\overline{\text{CHRG}}$  pin is pulled low by an internal N-channel MOSFET. When the charge current drops to 10% of the full-scale current, the  $\overline{\text{CHRG}}$  pin is forced to a high impedance state. If the battery voltage remains below 2.9V for one quarter of the charge time, the battery is considered defective and the  $\overline{\text{CHRG}}$  pin pulses at a frequency of 2Hz.

**BAT (Pin 3):** Charge Current Output. Provides charge current to the battery and regulates the final float voltage to 4.2V. An internal precision resistor divider on this pin sets the float voltage and is disconnected in shutdown mode.

**V<sub>CC</sub> (Pin 4):** Positive Input Supply Voltage. This pin provides power to the charger.  $V_{\text{CC}}$  can range from 3.75V to 5.5V. This pin should be bypassed with at least a 1 $\mu\text{F}$  capacitor. When  $V_{\text{CC}}$  is within 32mV of the BAT pin voltage, the LTC4065 enters shutdown mode, dropping  $I_{\text{BAT}}$  to about 1 $\mu\text{A}$ .

**$\overline{\text{EN}}$  (Pin 5, LTC4065 Only):** Enable Input Pin. Pulling this pin above the manual shutdown threshold ( $V_{\text{MS}}$  is typically 0.82V) puts the LTC4065 in shutdown mode. In shutdown mode, the LTC4065 has less than 20 $\mu\text{A}$  supply current and less than 1 $\mu\text{A}$  battery drain current. Enable is the default state, but the pin should be tied to GND if unused.

**$\overline{\text{ACPR}}$  (Pin 5, LTC4065A Only):** Open-Drain Power Supply Status Output. When  $V_{\text{CC}}$  is greater than the undervoltage lockout threshold (3.6V) and  $V_{\text{BAT}} + 80\text{mV}$  (if  $V_{\text{BAT}} > 3.6\text{V}$ ), the  $\overline{\text{ACPR}}$  pin will be pulled down to ground; otherwise the pin is high impedance.

**PROG (Pin 6):** Charge Current Program and Charge Current Monitor Pin. Connecting a 1% resistor,  $R_{\text{PROG}}$ , to ground programs the charge current. When charging in constant-current mode, this pin servos to 1V. In all modes, the voltage on this pin can be used to measure the charge current using the following formula:

$$I_{\text{BAT}} = \frac{V_{\text{PROG}}}{R_{\text{PROG}}} \cdot 1000$$

Floating the PROG pin sets the charge current to zero (LTC4065) or puts the part in shutdown mode (LTC4065A). In shutdown mode, the LTC4065A has less than 20 $\mu\text{A}$  supply current and about 1 $\mu\text{A}$  battery drain current.

**Exposed Pad (Pin 7):** Ground. The Exposed Pad must be soldered to the PCB ground to provide both electrical contact and rated thermal performance.

**SIMPLIFIED BLOCK DIAGRAMS**

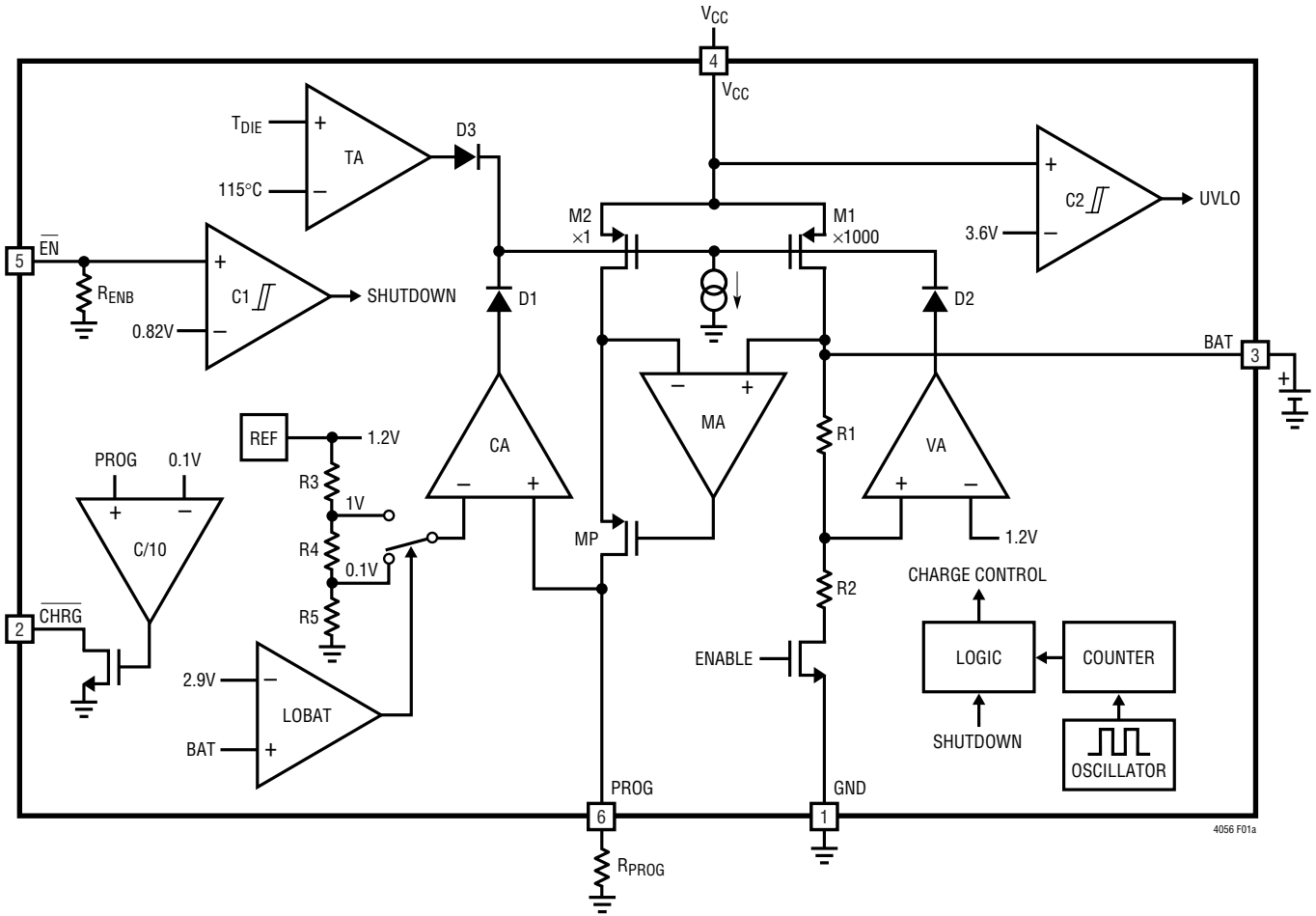

Figure 1a. LTC4065 Block Diagram



## SIMPLIFIED BLOCK DIAGRAMS

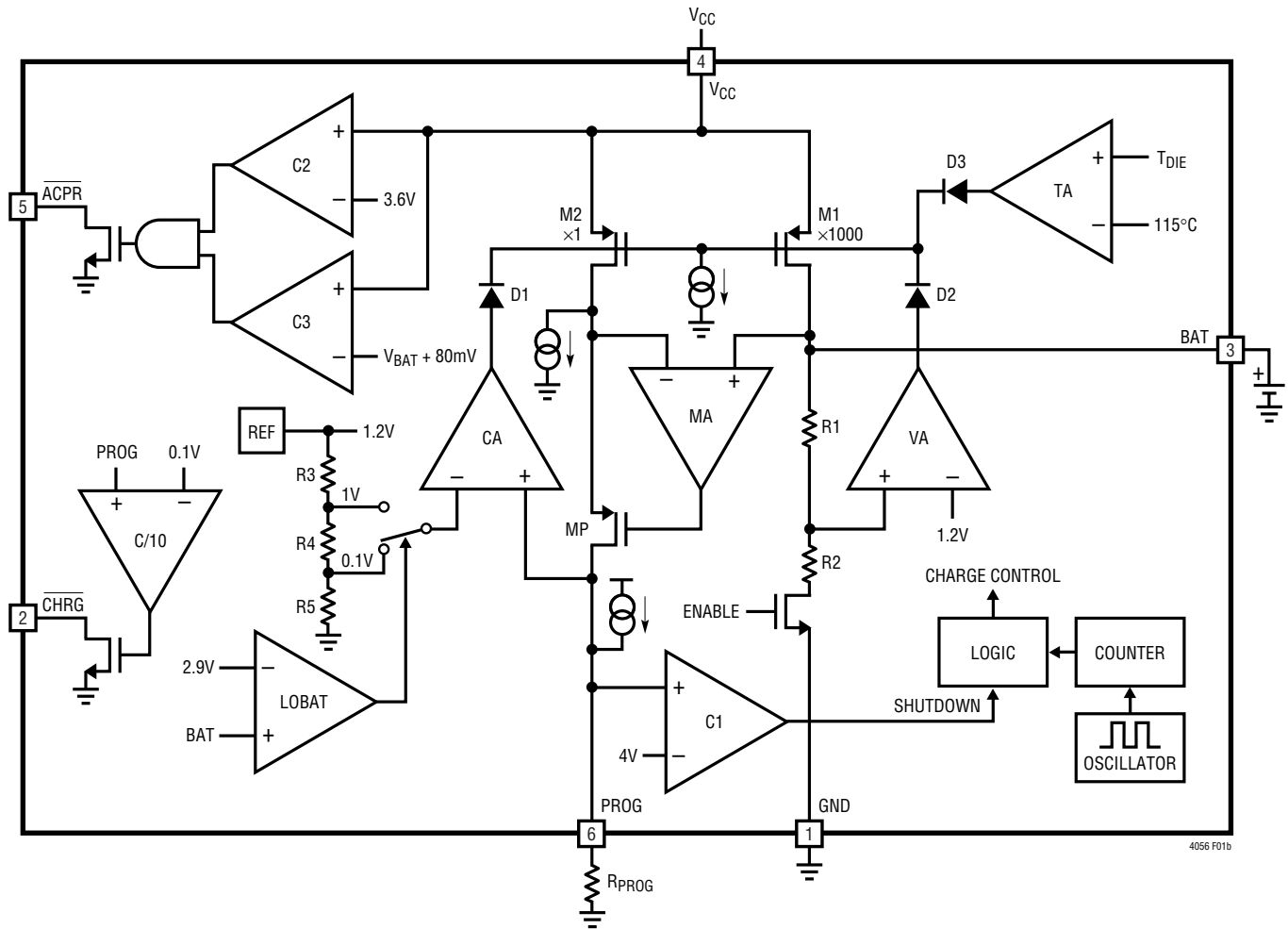

Figure 1b. LTC4065A Block Diagram

## OPERATION

The LTC4065 is a linear battery charger designed primarily for charging single cell lithium-ion batteries. Featuring an internal P-channel power MOSFET, the charger uses a constant-current/constant-voltage charge algorithm with programmable current. Charge current can be programmed up to 750mA with a final float voltage accuracy of  $\pm 0.6\%$ . The CHRG open-drain status output indicates if C/10 has been reached. No blocking diode or external sense resistor is required; thus, the basic charger circuit requires only two external components. The ACPR pin (LTC4065A) monitors the status of the input voltage with an open-drain output. An internal termination timer and trickle charge

low-battery conditioning adhere to battery manufacturer safety guidelines. Furthermore, the LTC4065 is capable of operating from a USB power source.

An internal thermal limit reduces the programmed charge current if the die temperature attempts to rise above a preset value of approximately 115°C. This feature protects the LTC4065 from excessive temperature and allows the user to push the limits of the power handling capability of a given circuit board without risk of damaging the LTC4065 or external components. Another benefit of the LTC4065 thermal limit is that charge current can be set according to

## OPERATION

typical, not worst-case, ambient temperatures for a given application with the assurance that the charger will automatically reduce the current in worst-case conditions.

The charge cycle begins when the following conditions are met: the voltage at the  $V_{CC}$  pin exceeds 3.6V and approximately 80mV above the BAT pin voltage, a program resistor is present from the PROG pin to ground and the  $\overline{EN}$  pin (LTC4065 only) is pulled below the shutdown threshold (typically 0.82V).

If the BAT pin voltage is below 2.9V, the charger goes into trickle charge mode, charging the battery at one-tenth the programmed charge current to bring the cell voltage up to a safe level for charging. If the BAT pin voltage is above 4.1V, the charger will not charge the battery as the cell is near full capacity. Otherwise, the charger goes into the fast charge constant-current mode.

When the BAT pin approaches the final float voltage (4.2V), the LTC4065 enters constant-voltage mode and the charge current begins to decrease. When the current drops to 10% of the full-scale charge current, an internal comparator turns off the N-channel MOSFET on the  $\overline{CHRG}$  pin and the pin assumes a high impedance state.

An internal timer sets the total charge time,  $t_{TIMER}$  (typically 4.5 hours). When this time elapses, the charge cycle terminates and the  $\overline{CHRG}$  pin assumes a high impedance state. To restart the charge cycle, remove the input voltage and reapply it, momentarily force the  $\overline{EN}$  pin above  $V_{MS}$  (typically 0.82V) for LTC4065, or momentarily float the PROG pin and reconnect it (LTC4065A). The charge cycle will automatically restart if the BAT pin voltage falls below  $V_{RECHRG}$  (typically 4.1V).

When the input voltage is not present, the battery drain current is reduced to less than 4 $\mu$ A. The LTC4065 can also be shut down by pulling the  $\overline{EN}$  pin above the shutdown threshold voltage. To put LTC4065A in shutdown mode, float the PROG pin. This reduces input quiescent current to less than 20 $\mu$ A and battery drain current to less than 1 $\mu$ A.

### Programming Charge Current

The charge current is programmed using a single resistor from the PROG pin to ground. The battery charge current is 1000 times the current out of the PROG pin. The

program resistor and the charge current are calculated using the following equations:

$$R_{PROG} = 1000 \cdot \frac{1V}{I_{CHG}}, I_{CHG} = \frac{1000V}{R_{PROG}}$$

The charge current out of the BAT pin can be determined at any time by monitoring the PROG pin voltage and using the following equation:

$$I_{BAT} = \frac{V_{PROG}}{R_{PROG}} \cdot 1000$$

### Undervoltage Lockout (UVLO)

An internal undervoltage lockout circuit monitors the input voltage and keeps the charger in undervoltage lockout until  $V_{CC}$  rises above 3.6V and approximately 80mV above the BAT pin voltage. The 3.6V UVLO circuit has a built-in hysteresis of approximately 0.6V and the automatic shutdown threshold has a built-in hysteresis of approximately 50mV. During undervoltage lockout conditions, maximum battery drain current is 4 $\mu$ A and maximum supply current is 11 $\mu$ A.

### Shutdown Mode

The LTC4065 can be disabled by pulling the  $\overline{EN}$  pin above the shutdown threshold (approximately 0.82V). The LTC4065A can be disabled by floating the PROG pin. In shutdown mode, the battery drain current is reduced to less than 1 $\mu$ A and the supply current to about 20 $\mu$ A.

### Timer and Recharge

The LTC4065 has an internal termination timer that starts when an input voltage greater than the undervoltage lockout threshold is applied to  $V_{CC}$ , or when leaving shutdown the battery voltage is less than the recharge threshold.

At power-up or when exiting shutdown, if the battery voltage is less than the recharge threshold, the charge time is set to 4.5 hours. If the battery voltage is greater than the recharge threshold at power-up or when exiting shutdown, the timer will not start and charging is prevented since the battery is at or near full capacity.

## OPERATION

Once the charge cycle terminates, the LTC4065 continuously monitors the BAT pin voltage using a comparator with a 2ms filter time. When the average battery voltage falls below 4.1V (which corresponds to 80% to 90% battery capacity), a new charge cycle is initiated and a 2.25 hour timer begins. This ensures that the battery is kept at, or near, a fully charged condition and eliminates the need for periodic charge cycle initiations. The  $\overline{\text{CHRG}}$  output assumes a strong pull-down state during recharge cycles until C/10 is reached when it transitions to a high impedance state.

### Trickle Charge and Defective Battery Detection

At the beginning of a charge cycle, if the battery voltage is low (below 2.9V), the charger goes into trickle charge, reducing the charge current to 10% of the full-scale current. If the low-battery voltage persists for one quarter of the total time (1.125 hour), the battery is assumed to be defective, the charge cycle is terminated and the  $\overline{\text{CHRG}}$  pin output pulses at a frequency of 2Hz with a 75% duty cycle. If for any reason the battery voltage rises above 2.9V, the charge cycle will be restarted. To restart the charge cycle (i.e., when the defective battery is replaced with a discharged battery), simply remove the input voltage and reapply it, temporarily pull the  $\overline{\text{EN}}$  pin above the shutdown threshold (LTC4065), or momentarily float the PROG pin and reconnect it (LTC4065A).

### $\overline{\text{CHRG}}$ Status Output Pin

The charge status indicator pin has three states: pull-down, pulse at 2Hz (see Trickle Charge and Defective Battery Detection) and high impedance. The pull-down state indicates that the LTC4065 is in a charge cycle. A high impedance state indicates that the charge current has dropped below 10% of the full-scale current or the LTC4065 is disabled. Figure 2 shows the  $\overline{\text{CHRG}}$  status under various conditions.

### Power Supply Status Indicator ( $\overline{\text{ACPR}}$ , LTC4065A Only)

The power supply status output has two states: pull-down and high impedance. The pull-down state indicates that  $V_{\text{CC}}$  is above the undervoltage lockout threshold (see Undervoltage Lockout). When this condition is not met,

the  $\overline{\text{ACPR}}$  pin is high impedance indicating that the LTC4065A is unable to charge the battery.

### Charge Current Soft-Start and Soft-Stop

The LTC4065 includes a soft-start circuit to minimize the inrush current at the start of a charge cycle. When a charge cycle is initiated, the charge current ramps from zero to the full-scale current over a period of approximately 180 $\mu\text{s}$ . Likewise, internal circuitry slowly ramps the charge current from full-scale to zero when the charger is shut off or self terminates. This has the effect of minimizing the transient current load on the power supply during start-up and charge termination.

### Constant-Current/Constant-Voltage/ Constant-Temperature

The LTC4065/LTC4065A use a unique architecture to charge a battery in a constant-current, constant-voltage and constant-temperature fashion. Figures 1a and 1b show simplified block diagrams of the LTC4065 and LTC4065A, respectively. Three of the amplifier feedback loops shown control the constant-current, CA, constant-voltage, VA, and constant-temperature, TA modes. A fourth amplifier feedback loop, MA, is used to increase the output impedance of the current source pair; M1 and M2 (note that M1 is the internal P-channel power MOSFET). It ensures that the drain current of M1 is exactly 1000 times greater than the drain current of M2.

Amplifiers CA and VA are used in separate feedback loops to force the charger into constant-current or constant-voltage mode, respectively. Diodes D1 and D2 provide priority to either the constant-current or constant-voltage loop; whichever is trying to reduce the charge current the most. The output of the other amplifier saturates low which effectively removes its loop from the system. When in constant-current mode, CA servos the voltage at the PROG pin to be precisely 1V. VA servos its inverting input to an internal reference voltage when in constant-voltage mode and the internal resistor divider, made up of R1 and R2, ensures that the battery voltage is maintained at 4.2V. The PROG pin voltage gives an indication of the charge current during constant-voltage mode as discussed in "Programming Charge Current".

## OPERATION

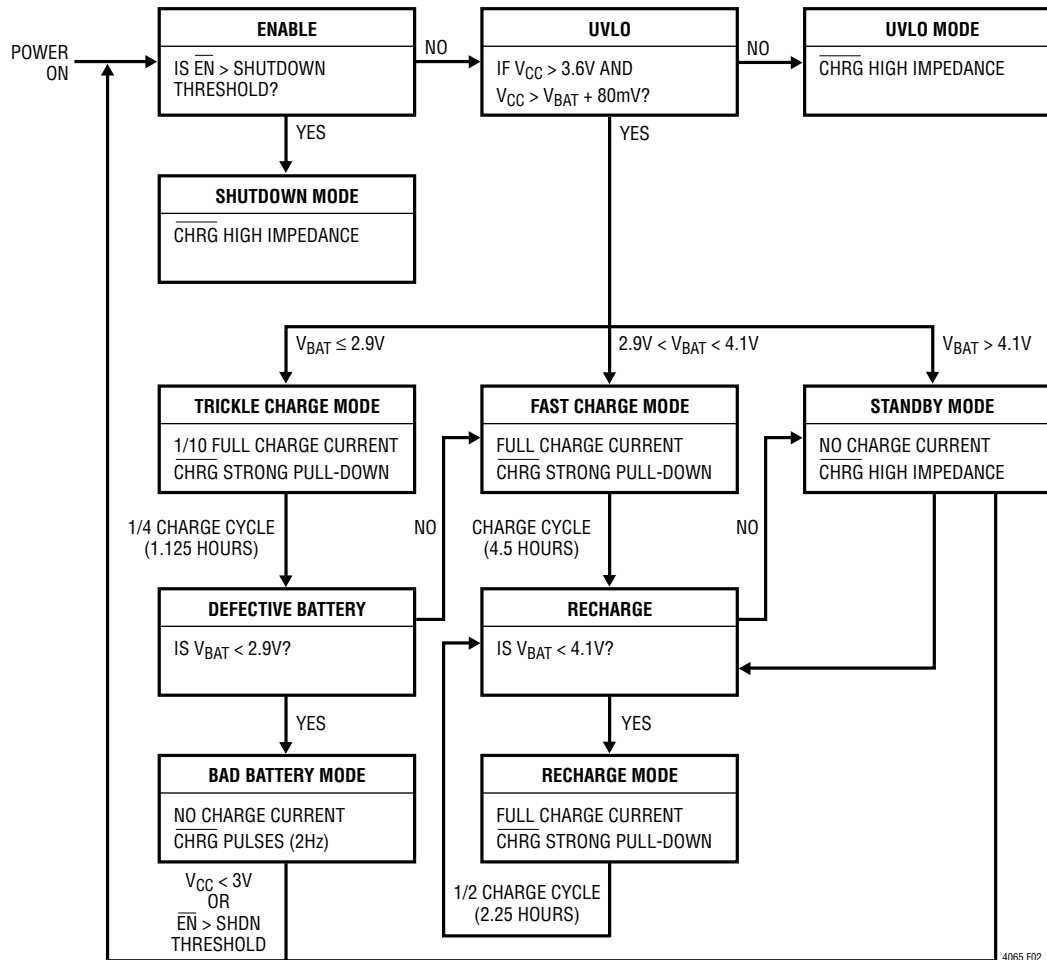

Figure 2. State Diagram of LTC4065 Operation

Transconductance amplifier, TA, limits the die temperature to approximately 115°C when in constant-temperature mode. Diode D3 ensures that TA does not affect the charge current when the die temperature is below approximately 115°C. The PROG pin voltage continues to give an indication of the charge current.

In typical operation, the charge cycle begins in constant-current mode with the current delivered to the battery equal to  $1000V/R_{PROG}$ . If the power dissipation of the

LTC4065/LTC4065A results in the junction temperature approaching 115°C, the amplifier (TA) will begin decreasing the charge current to limit the die temperature to approximately 115°C. As the battery voltage rises, the LTC4065/LTC4065A either return to constant-current mode or enter constant-voltage mode straight from constant-temperature mode. Regardless of mode, the voltage at the PROG pin is proportional to the current delivered to the battery.

## APPLICATIONS INFORMATION

### Undervoltage Charge Current Limiting (UVCL)

The LTC4065/LTC4065A includes undervoltage charge ( $\Delta V_{UVCL1}$ ) current limiting that prevents full charge current until the input supply voltage reaches approximately 200mV above the battery voltage. This feature is particularly useful if the LTC4065 is powered from a supply with long leads (or any relatively high output impedance).

For example, USB-powered systems tend to have highly variable source impedances (due primarily to cable quality and length). A transient load combined with such impedance can easily trip the UVLO threshold and turn the charger off unless undervoltage charge current limiting is implemented.

Consider a situation where the LTC4065 is operating under normal conditions and the input supply voltage begins to droop (e.g., an external load drags the input supply down). If the input voltage reaches  $V_{BAT} + \Delta V_{UVCL1}$  (approximately 220mV above the battery voltage), undervoltage charge current limiting will begin to reduce the charge current in an attempt to maintain  $\Delta V_{UVCL1}$  between the  $V_{CC}$  input and the BAT output of the IC. The LTC4065 will continue to operate at the reduced charge current until the input supply voltage is increased or voltage mode reduces the charge current further.

### Operation from Current Limited Wall Adapter

By using a current limited wall adapter as the input supply, the LTC4065 dissipates significantly less power when programmed for a current higher than the limit of the supply as compared to using a non-current limited supply at the same charge current.

Consider a situation where an application demands a 600mA charge current for an 800mAh Li-Ion battery. If a typical 5V (non-current limited) input supply is available then the peak power dissipation inside the part can exceed 1W.

Now consider the same scenario, but with a 5V input supply with a 600mA current limit. To take advantage of the supply, it is necessary to program the LTC4065 to charge at a current above 600mA. Assume that the LTC4065 is programmed for 650mA (i.e.,  $R_{PROG} = 1.54k$ ) to ensure that part tolerances maintain a programmed current higher

than 600mA. Since the LTC4065 will demand a charge current higher than the current limit of the voltage supply, the supply voltage will drop to the battery voltage plus 600mA times the “on” resistance of the internal PFET. The “on” resistance of the LTC4065 power device is approximately 450m $\Omega$  with a 5V supply. The actual “on” resistance will be slightly higher due to the fact that the input supply will drop to less than 5V. The power dissipated during this phase of charging is less than 240mW. That is a 76% improvement over the non-current limited supply power dissipation.

### USB and Wall Adapter Power

Although the LTC4065/LTC4065A allow charging from a USB port, a wall adapter can also be used to charge Li-Ion batteries. Figure 3 shows an example of how to combine wall adapter and USB power inputs. A P-channel MOSFET, MP1, is used to prevent back conducting into the USB port when a wall adapter is present and Schottky diode, D1, is used to prevent USB power loss through the 1k pull-down resistor.

Typically a wall adapter can supply significantly more current than the 500mA-limited USB port. Therefore, an N-channel MOSFET, MN1, and an extra program resistor are used to increase the charge current to 750mA when the wall adapter is present.

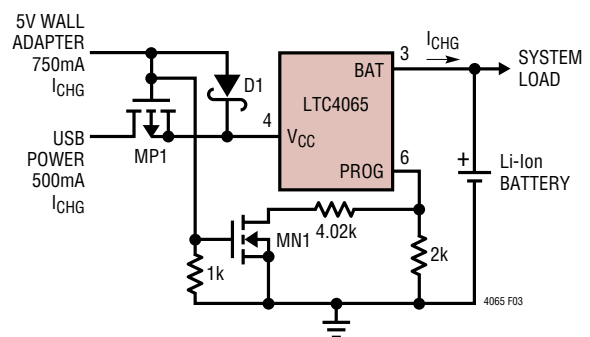

Figure 3. Combining Wall Adapter and USB Power

### Stability Considerations

The LTC4065/LTC4065A contain two control loops: constant-voltage and constant-current. The constant-voltage loop is stable without any compensation when a battery is connected with low impedance leads. Excessive lead

## APPLICATIONS INFORMATION

length, however, may add enough series inductance to require a bypass capacitor of at least  $1\mu\text{F}$  from BAT to GND. Furthermore, a  $4.7\mu\text{F}$  capacitor with a  $0.2\Omega$  to  $1\Omega$  series resistor from BAT to GND is required to keep ripple voltage low when the battery is disconnected.

High value capacitors with very low ESR (especially ceramic) may reduce the constant-voltage loop phase margin. Ceramic capacitors up to  $22\mu\text{F}$  may be used in parallel with a battery, but larger ceramics should be decoupled with  $0.2\Omega$  to  $1\Omega$  of series resistance.

In constant-current mode, the PROG pin is in the feedback loop, not the battery. Because of the additional pole created by the PROG pin capacitance, capacitance on this pin must be kept to a minimum. With no additional capacitance on the PROG pin, the charger is stable with program resistor values as high as  $25\text{k}$ . However, additional capacitance on this node reduces the maximum allowed program resistor. The pole frequency at the PROG pin should be kept above  $100\text{kHz}$ . Therefore, if the PROG pin is loaded with a capacitance,  $C_{\text{PROG}}$ , the following equation should be used to calculate the maximum resistance value for  $R_{\text{PROG}}$ :

$$R_{\text{PROG}} \leq \frac{1}{2\pi \cdot 10^5 \cdot C_{\text{PROG}}}$$

Average, rather than instantaneous, battery current may be of interest to the user. For example, if a switching power supply operating in low current mode is connected in parallel with the battery, the average current being pulled out of the BAT pin is typically of more interest than the instantaneous current pulses. In such a case, a simple RC filter can be used on the PROG pin to measure the average battery current as shown in Figure 4. A  $10\text{k}$  resistor has been added between the PROG pin and the filter capacitor to ensure stability.

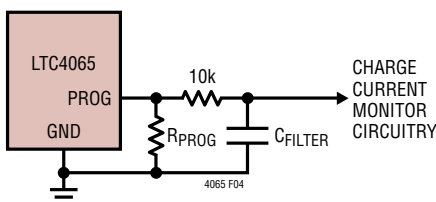

Figure 4. Isolating Capacitive Load on the PROG Pin and Filtering

### Power Dissipation

The conditions that cause the LTC4065/LTC4065A to reduce charge current through thermal feedback can be approximated by considering the power dissipated in the IC. For high charge currents, the LTC4065/LTC4065A power dissipation is approximately:

$$P_D = (V_{\text{CC}} - V_{\text{BAT}}) \cdot I_{\text{BAT}}$$

Where  $P_D$  is the power dissipated,  $V_{\text{CC}}$  is the input supply voltage,  $V_{\text{BAT}}$  is the battery voltage and  $I_{\text{BAT}}$  is the charge current. It is not necessary to perform any worst-case power dissipation scenarios because the LTC4065 will automatically reduce the charge current to maintain the die temperature at approximately  $115^\circ\text{C}$ . However, the approximate ambient temperature at which the thermal feedback begins to protect the IC is:

$$T_A = 115^\circ\text{C} - P_D \cdot \theta_{\text{JA}}$$

$$T_A = 115^\circ\text{C} - (V_{\text{CC}} - V_{\text{BAT}}) \cdot I_{\text{BAT}} \cdot \theta_{\text{JA}}$$

Example: Consider an LTC4065/LTC4065A operating from a  $5\text{V}$  wall adapter providing  $750\text{mA}$  to a  $3.6\text{V}$  Li-Ion battery. The ambient temperature above which the LTC4065/LTC4065A will begin to reduce the  $750\text{mA}$  charge current is approximately:

$$T_A = 115^\circ\text{C} - (5\text{V} - 3.6\text{V}) \cdot (750\text{mA}) \cdot 60^\circ\text{C/W}$$

$$T_A = 115^\circ\text{C} - 1.05\text{W} \cdot 60^\circ\text{C/W} = 115^\circ\text{C} - 63^\circ\text{C}$$

$$T_A = 52^\circ\text{C}$$

The LTC4065/LTC4065A can be used above  $70^\circ\text{C}$ , but the charge current will be reduced from  $750\text{mA}$ . The approximate current at a given ambient temperature can be calculated:

$$I_{\text{BAT}} = \frac{115^\circ\text{C} - T_A}{(V_{\text{CC}} - V_{\text{BAT}}) \cdot \theta_{\text{JA}}}$$

Using the previous example with an ambient temperature of  $73^\circ\text{C}$ , the charge current will be reduced to approximately:

$$I_{\text{BAT}} = \frac{115^\circ\text{C} - 73^\circ\text{C}}{(5\text{V} - 3.6\text{V}) \cdot 60^\circ\text{C/W}} = \frac{42^\circ\text{C}}{84^\circ\text{C/A}} = 500\text{mA}$$

## APPLICATIONS INFORMATION

Furthermore, the voltage at the PROG pin will change proportionally with the charge current as discussed in the Programming Charge Current section.

It is important to remember that LTC4065/LTC4065A applications do not need to be designed for worst-case thermal conditions since the IC will automatically reduce power dissipation when the junction temperature reaches approximately 115°C.

### Board Layout Considerations

In order to deliver maximum charge current under all conditions, it is critical that the exposed metal pad on the backside of the LTC4065/LTC4065A package is soldered to the PC board ground. Correctly soldered to a 2500mm<sup>2</sup> double-sided 1 oz. copper board the LTC4065/LTC4065A has a thermal resistance of approximately 60°C/W. Failure to make thermal contact between the Exposed Pad on the

backside of the package and the copper board will result in thermal resistances far greater than 60°C/W. As an example, a correctly soldered LTC4065/LTC4065A can deliver over 750mA to a battery from a 5V supply at room temperature. Without a backside thermal connection, this number could drop to less than 500mA.

### V<sub>CC</sub> Bypass Capacitor

Many types of capacitors can be used for input bypassing; however, caution must be exercised when using multi-layer ceramic capacitors. Because of the self-resonant and high Q characteristics of some types of ceramic capacitors, high voltage transients can be generated under some start-up conditions, such as connecting the charger input to a live power source. For more information, refer to Application Note 88.

## PACKAGE DESCRIPTION

**DC Package**  
**6-Lead Plastic DFN (2mm × 2mm)**  
 (Reference LTC DWG # 05-08-1703)

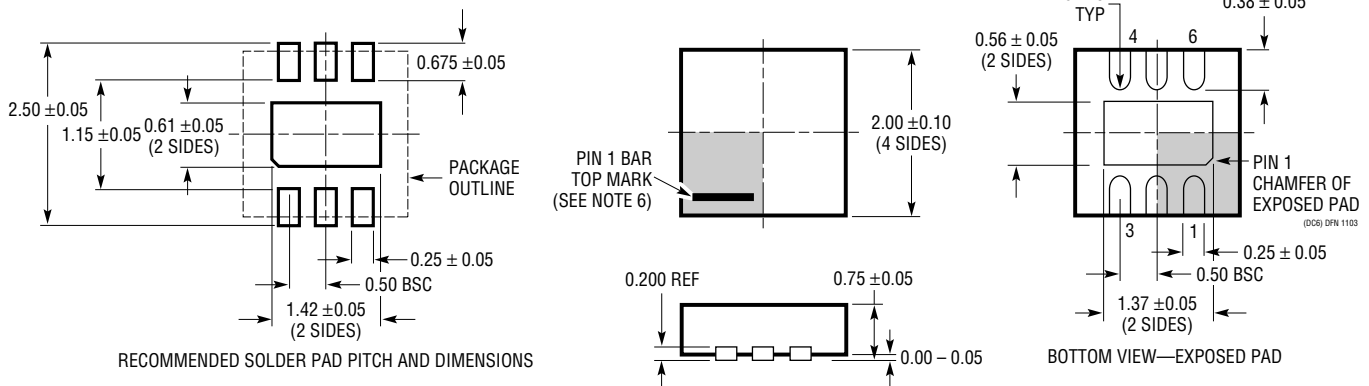

**NOTE:**

1. DRAWING TO BE MADE A JEDEC PACKAGE OUTLINE M0-229 VARIATION OF (WCCD-2)
2. DRAWING NOT TO SCALE
3. ALL DIMENSIONS ARE IN MILLIMETERS
4. DIMENSIONS OF EXPOSED PAD ON BOTTOM OF PACKAGE DO NOT INCLUDE MOLD FLASH. MOLD FLASH, IF PRESENT, SHALL NOT EXCEED 0.15mm ON ANY SIDE
5. EXPOSED PAD SHALL BE SOLDER PLATED
6. SHADED AREA IS ONLY A REFERENCE FOR PIN 1 LOCATION ON THE TOP AND BOTTOM OF PACKAGE

**RELATED PARTS**

PART NUMBER	DESCRIPTION	COMMENTS
<b>Battery Chargers</b>		
LTC1734	Lithium-Ion Linear Battery Charger in ThinSOT™	Simple ThinSOT Charger, No Blocking Diode, No Sense Resistor Needed
LTC1734L	Lithium-Ion Linear Battery Charger in ThinSOT	Low Current Version of LTC1734, $50\text{mA} \leq I_{\text{CHRG}} \leq 180\text{mA}$
LTC4002	Switch Mode Lithium-Ion Battery Charger	Standalone, $4.7\text{V} \leq V_{\text{IN}} \leq 24\text{V}$ , 500kHz Frequency, 3 Hour Charge Termination
LTC4050	Lithium-Ion Linear Battery Charger Controller	Features Preset Voltages, C/10 Charger Detection and Programmable Timer, Input Power Good Indication, Thermistor Interface
LTC4052	Monolithic Lithium-Ion Battery Pulse Charger	No Blocking Diode or External Power FET Required, $\leq 1.5\text{A}$ Charge Current
LTC4053	USB Compatible Monolithic Li-Ion Battery Charger	Standalone Charger with Programmable Timer, Up to 1.25A Charge Current
LTC4054	Standalone Linear Li-Ion Battery Charger with Integrated Pass Transistor in ThinSOT	Thermal Regulation Prevents Overheating, C/10 Termination, C/10 Indicator, Up to 800mA Charge Current
LTC4057	Lithium-Ion Linear Battery Charger	Up to 800mA Charge Current, Thermal Regulation, ThinSOT Package
LTC4058	Standalone 950mA Lithium-Ion Charger in DFN	C/10 Charge Termination, Battery Kelvin Sensing, $\pm 7\%$ Charge Accuracy
LTC4059	900mA Linear Lithium-Ion Battery Charger	2mm $\times$ 2mm DFN Package, Thermal Regulation, Charge Current Monitor Output
LTC4059A	900mA Linear Lithium-Ion Battery Charger	2mm $\times$ 2mm DFN Package, Thermal Regulation, Charge Current Monitor Output, ACPR Function
LTC4061	Standalone Li-Ion Charger with Thermistor Interface	4.2V, $\pm 0.35\%$ Float Voltage, Up to 1A Charge Current, 3mm $\times$ 3mm DFN
LTC4061-4.4	Standalone Li-Ion Charger with Thermistor Interface	4.4V (Max), $\pm 0.4\%$ Float Voltage, Up to 1A Charge Current, 3mm $\times$ 3mm DFN
LTC4062	Standalone Linear Li-Ion Battery Charger with Micropower Comparator	4.2V, $\pm 0.35\%$ Float Voltage, Up to 1A Charge Current, 3mm $\times$ 3mm DFN
LTC4063	Li-Ion Charger with Linear Regulator	Up to 1A Charge Current, 100mA, 125mV LDO, 3mm $\times$ 3mm DFN
LTC4411/LTC4412	Low Loss PowerPath™ Controller in ThinSOT	Automatic Switching Between DC Sources, Load Sharing, Replaces ORing Diodes
<b>Power Management</b>		
LTC3405/LTC3405A	300mA ( $I_{\text{OUT}}$ ), 1.5MHz, Synchronous Step-Down DC/DC Converter	95% Efficiency, $V_{\text{IN}}$ : 2.7V to 6V, $V_{\text{OUT}} = 0.8\text{V}$ , $I_{\text{Q}} = 20\mu\text{A}$ , $I_{\text{SD}} < 1\mu\text{A}$ , ThinSOT Package
LTC3406/LTC3406A	600mA ( $I_{\text{OUT}}$ ), 1.5MHz, Synchronous Step-Down DC/DC Converter	95% Efficiency, $V_{\text{IN}}$ : 2.5V to 5.5V, $V_{\text{OUT}} = 0.6\text{V}$ , $I_{\text{Q}} = 20\mu\text{A}$ , $I_{\text{SD}} < 1\mu\text{A}$ , ThinSOT Package
LTC3411	1.25A ( $I_{\text{OUT}}$ ), 4MHz, Synchronous Step-Down DC/DC Converter	95% Efficiency, $V_{\text{IN}}$ : 2.5V to 5.5V, $V_{\text{OUT}} = 0.8\text{V}$ , $I_{\text{Q}} = 60\mu\text{A}$ , $I_{\text{SD}} < 1\mu\text{A}$ , MS Package
LTC3440	600mA ( $I_{\text{OUT}}$ ), 2MHz, Synchronous Buck-Boost DC/DC Converter	95% Efficiency, $V_{\text{IN}}$ : 2.5V to 5.5V, $V_{\text{OUT}} = 2.5\text{V}$ , $I_{\text{Q}} = 25\mu\text{A}$ , $I_{\text{SD}} < 1\mu\text{A}$ , MS Package
LTC4413	Dual Ideal Diode in DFN	2-Channel Ideal Diode ORing, Low Forward ON Resistance, Low Regulated Forward Voltage, $2.5\text{V} \leq V_{\text{IN}} \leq 5.5\text{V}$

ThinSOT and PowerPath are trademarks of Linear Technology Corporation.





Компания «ЭлектроПласт» предлагает заключение долгосрочных отношений при поставках импортных электронных компонентов на взаимовыгодных условиях!

Наши преимущества:

- Оперативные поставки широкого спектра электронных компонентов отечественного и импортного производства напрямую от производителей и с крупнейших мировых складов;
- Поставка более 17-ти миллионов наименований электронных компонентов;
- Поставка сложных, дефицитных, либо снятых с производства позиций;
- Оперативные сроки поставки под заказ (от 5 рабочих дней);
- Экспресс доставка в любую точку России;
- Техническая поддержка проекта, помощь в подборе аналогов, поставка прототипов;
- Система менеджмента качества сертифицирована по Международному стандарту ISO 9001;
- Лицензия ФСБ на осуществление работ с использованием сведений, составляющих государственную тайну;
- Поставка специализированных компонентов (Xilinx, Altera, Analog Devices, Intersil, Interpoint, Microsemi, Aeroflex, Peregrine, Syfer, Eurofarad, Texas Instrument, Miteq, Cobham, E2V, MA-COM, Hittite, Mini-Circuits, General Dynamics и др.);

Помимо этого, одним из направлений компании «ЭлектроПласт» является направление «Источники питания». Мы предлагаем Вам помощь Конструкторского отдела:

- Подбор оптимального решения, техническое обоснование при выборе компонента;
- Подбор аналогов;
- Консультации по применению компонента;
- Поставка образцов и прототипов;
- Техническая поддержка проекта;
- Защита от снятия компонента с производства.



#### Как с нами связаться

**Телефон:** 8 (812) 309 58 32 (многоканальный)

**Факс:** 8 (812) 320-02-42

**Электронная почта:** [org@eplast1.ru](mailto:org@eplast1.ru)

**Адрес:** 198099, г. Санкт-Петербург, ул. Калинина, дом 2, корпус 4, литера А.