

E3HF/E3HS/E3HT/E3HC

CSM_E3HF_E3HS_E3HT_E3HC_DS_E_4_1

- Cylindrical models (E3HT and E3HC) are ideal for embedded installation.
- Square 7.5-mm model (E3HS) has a sensing distance of 1 m.
- Resin-filled models (E3HS and E3HC) offer excellent vibration resistance.
- Ultra-thin 7-mm model (E3HF) requires very little depth for installation, helping to save space.
- E3HT and E3HC comply with EN standards.













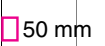

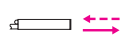
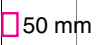
 Be sure to read *Safety Precautions* on page 6.

Ordering Information

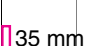
Sensors

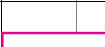
 Infrared light

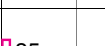
Sensing Method	Appearance	Sensing distance	Model	
			Light- ON	Dark-ON
Through-beam *		 700 mm	E3HF-1E1 Emitter E3HF-1L Receiver E3HF-1DE1	E3HF-1E2 Emitter E3HF-1L Receiver E3HF-1DE2
Diffuse-reflective		 50 mm	E3HF-DS5E1	E3HF-DS5E2
Through-beam *		 1 m	E3HS-1E1 Emitter E3HS-1L Receiver E3HS-1DE1	E3HS-1E2 Emitter E3HS-1L Receiver E3HS-1DE2
Diffuse-reflective		 50 mm	E3HS-DS5E1	E3HS-DS5E2
Through-beam *		 1 m	E3HT-1E1 Emitter E3HT-1L Receiver E3HT-1DE1	E3HT-1E2 Emitter E3HT-1L Receiver E3HT-1DE2
Diffuse-reflective		 35 mm	E3HT-DS3E1	E3HT-DS3E2
Through-beam *		 1 m	E3HC-1E1 Emitter E3HC-1L Receiver E3HC-1DE1	E3HC-1E2 Emitter E3HC-1L Receiver E3HC-1DE2
Diffuse-reflective		 35 mm	E3HC-DS3E1	E3HC-DS3E2



* Through-beam Sensors are normally sold in sets that include both the Emitter and Receiver. Orders for individual Emitters and Receivers are accepted.

Accessories

Slits

Slit width	Sensing distance	Minimum detectable object (typical)	Quantity	Remarks
0.5 mm × 4 mm	120 mm	0.5-mm dia.	1 slit each for the Emitter and Receiver (6 slits total)	Seal-type long slit Provided with the E3HF-1E□ Through-beam Sensor.
1 mm × 4 mm	200 mm	1-mm dia.		
2 mm × 4 mm	400 mm	2-mm dia.		

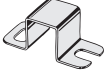
Mounting Brackets

Appearance	Model	Quantity	Remark
	E39-L101	1	Provided with the E3HS
	E39-L84	1	Provided with the E3HC

Note: When using through-beam models, order one bracket for the Receiver and one for the Emitter.

Ratings and Specifications

E3HF/E3HS

Sensing method Item	Through-beam		Diffuse-reflective	
	Model	E3HF-1E□	E3HF-DS5E□	E3HS-1E□
Sensing distance	700 mm	50 mm (White paper 30 × 30 mm)	1 m	50 mm (White paper 30 × 30 mm)
Standard sensing object	Opaque, 3.7-mm dia. min.	---	Opaque, 5.1-mm dia. min.	---
Differential travel	---	20% max. of sensing distance	---	20% max. of sensing distance
Directional angle	Emitter/Receiver: 3 to 20° each	---	Emitter/Receiver: 3 to 25° each	---
Light source (wavelength)	Infrared LED (950 nm)			
Power supply voltage	12 to 24 VDC ±10%, ripple (p-p): 10% max.			
Current consumption	Emitter/Receiver: 20 mA max.	30 mA max.	Emitter/Receiver: 20 mA max.	30 mA max.
Control output	Load power supply voltage: 24 VDC max., Load current: 80 mA (residual voltage: E3HF: 1 V max., E3HS: 1.2 V max.) NPN voltage output type Light-ON/Dark-ON (depends on model)			
Protection	Reverse polarity protection, Output short-circuit protection	Reverse polarity protection, Output short-circuit protection, Mutual interference prevention	Reverse polarity protection, Output short-circuit protection	Reverse polarity protection, Output short-circuit protection, Mutual interference prevention
Response time	Operate or reset: 5 ms max. each	Operate or reset: 3 ms max. each	Operate or reset: 5 ms max. each	Operate or reset: 3 ms max. each
Sensitivity adjustment	---	One-turn adjuster	---	One-turn adjuster
Ambient illuminance (Receiver side)	Incandescent lamp: 3,000 lx, Sunlight 10,000 lx			
Ambient temperature	Operating: -25 to 55°C, Storage: -30 to 70°C (with no icing or condensation)			
Ambient humidity	Operating: 35% to 85%, Storage: 35% to 95% (with no condensation)			
Insulation resistance	20 MΩ min. at 500 VDC			
Dielectric strength	500 VAC at 50/60 Hz for 1 minute			
Vibration resistance (destruction)	10 to 55 Hz, 1.5-mm double amplitude for 2 hours each in X, Y, and Z directions			
Shock resistance (destruction)	500 m/s ² for 3 times each in X, Y, and Z directions			
Degree of protection	IEC IP64		IEC IP65	
Connection method	Pre-wired models (standard length: 2 m)			
Weight (packed state)	Approx. 110 g	Approx. 70 g	Approx. 120 g	Approx. 80 g
Material	Case	ABS		Stainless steel (SUS304)
	Lens	Methacrylic resin		
	Mounting Brackets	---		Stainless steel (SUS304)
Accessories	Slit (0.5-mm, 1-mm, 2-mm widths), Instruction sheet	Screwdriver for adjustment, Instruction sheet	Mounting Bracket (with screws), Stoppers, Instruction sheet	Mounting Bracket (with screws), Screwdriver for adjustment, Stoppers, Instruction sheet

E3HT/E3HC

Sensing method Item	Through-beam		Diffuse-reflective		
	Model		Model		
	E3HT-1E□	E3HT-DS3E□	E3HC-1E□	E3HC-DS3E□	
Sensing distance	1 m	35 mm (White paper 30 × 30 mm)	1 m	35 mm (White paper 30 × 30 mm)	
Standard sensing object	Opaque, 6.25-mm dia. min.	---	Opaque, 6.25-mm dia. min.	---	
Differential travel	---	20% max. of sensing distance	---	20% max. of sensing distance	
Directional angle	Emitter/Receiver: 10 to 25° each	---	Emitter/Receiver: 10 to 25° each	---	
Light source (wavelength)	Infrared LED (950 nm)	Infrared LED (940 nm)	Infrared LED (950 nm)	Infrared LED (940 nm)	
Power supply voltage	12 to 24 VDC ±10%, ripple (p-p): 10% max.				
Current consumption	Emitter: 25 mA max. Receiver: 15 mA max.	30 mA max.	Emitter: 25 mA max. Receiver: 15 mA max.	30 mA max.	
Control output	Load power supply voltage: 24 VDC max., Load current: 80 mA (Residual voltage: 1 V max.) NPN open collector output type Light-ON/Dark-ON (depends on model)				
Protection	Reverse polarity protection, Output short-circuit protection	Reverse polarity protection, Output short-circuit protection, Mutual interference prevention	Reverse polarity protection, Output short-circuit protection	Reverse polarity protection, Output short-circuit protection, Mutual interference prevention	
Response time	Operate or reset: 5 ms max. each	Operate or reset: 3 ms max. each	Operate or reset: 5 ms max. each	Operate or reset: 3 ms max. each	
Ambient illuminance (Receiver side)	Incandescent lamp: 3,000 lx, Sunlight 10,000 lx				
Ambient temperature	Operating: -25 to 55°C, Storage: -30 to 70°C (with no icing or condensation)				
Ambient humidity	Operating: 35% to 85%, Storage: 35% to 95% (with no condensation)				
Insulation resistance	20 MΩ min. at 500 VDC				
Dielectric strength	500 VAC at 50/60 Hz for 1 minute				
Vibration resistance	Destruction: 10 to 55 Hz, 1.5-mm double amplitude for 2 hours each in X, Y, and Z directions				
Shock resistance	Destruction: 500 m/s ² for 3 times each in X, Y, and Z directions				
Degree of protection	IEC IP66				
Connection method	Pre-wired models (standard length: 2 m)				
Weight (packed state)	Approx. 130 g	Approx. 80 g	Approx. 110 g	Approx. 75 g	
Material	Case	Brass		Stainless steel (SUS304)	
	Lens	Methacrylic resin			
	Mounting Brackets	---		Stainless steel (SUS304)	
Accessories	Instruction sheet		Mounting bracket (with screws), Instruction sheet		

Engineering Data (Typical)

Parallel Operating Range

Through-beam

E3HF-1E□

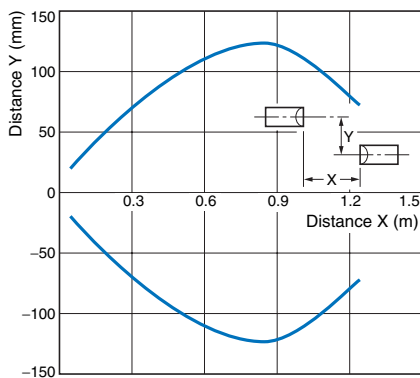

Through-beam

E3HF-1E□

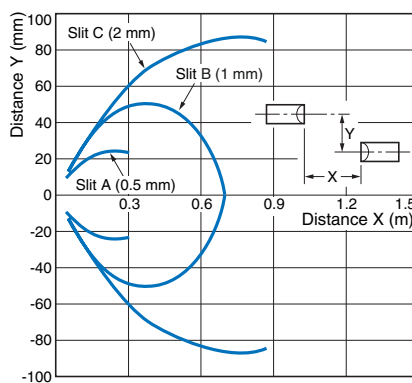

Through-beam

E3HS-1E□

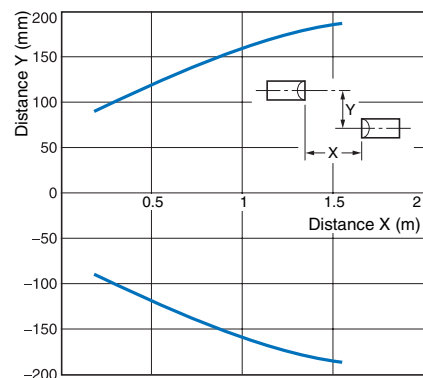

Through-beam E3HT-1E□, E3HC-1E□

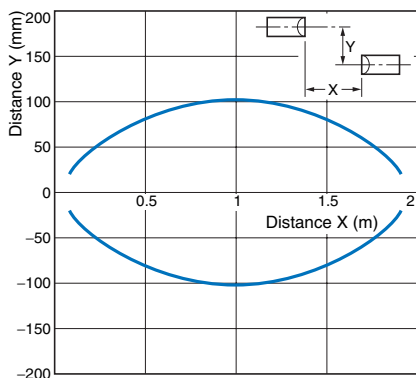

Operating Range Diffuse-reflective E3HF-DS5E□

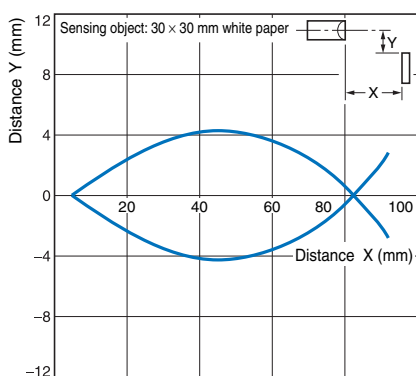

Diffuse-reflective E3HS-DS5E□

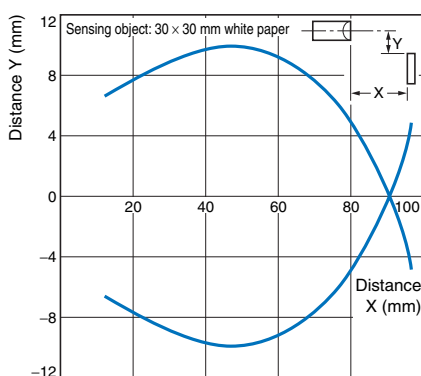

Diffuse-reflective E3HT-DS3E□, E3HC-DS3E□

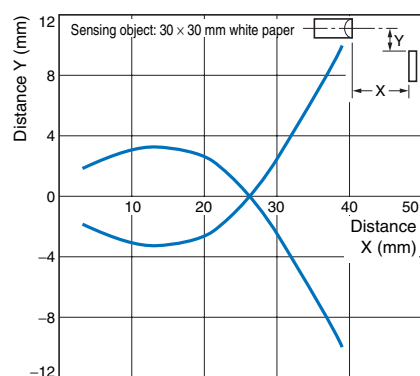

Excess Gain vs. Set Distance Through-beam E3HF-1E□

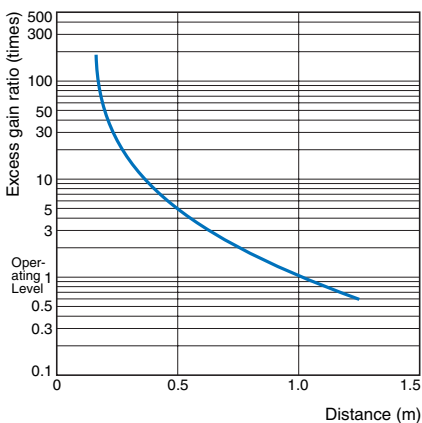

Through-beam E3HS-1E□

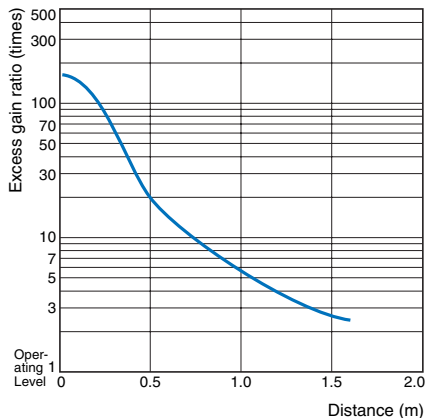

Through-beam E3HT-1E□, E3HC-1E□

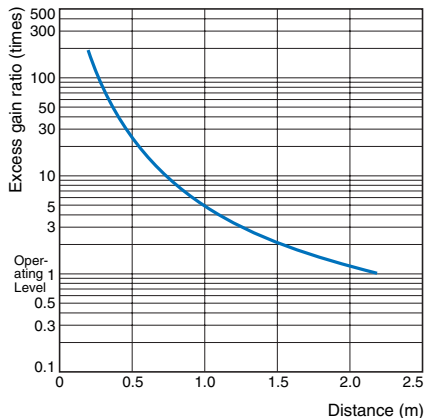

Diffuse-reflective E3HF-DS5E□

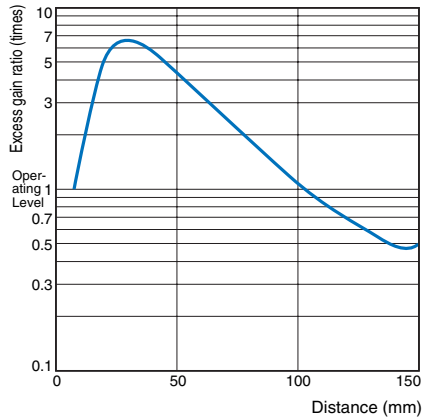

Diffuse-reflective E3HS-DS5E□

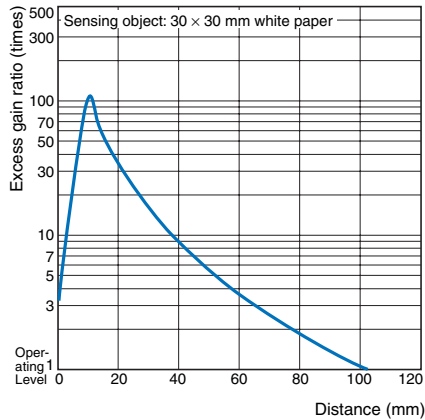

Diffuse-reflective E3HT-DS3E□, E3HC-DS3E□

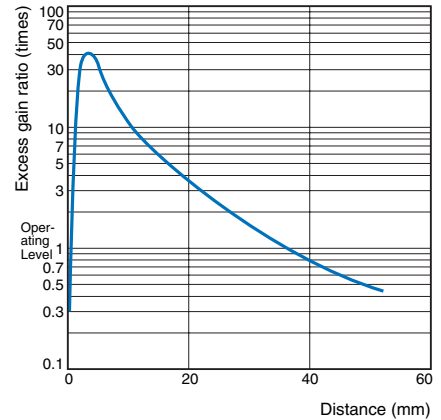

I/O Circuit Diagrams

NPN Output

Model	Operation mode	Timing charts	Output circuit
E3HF-1E1 * E3HF-DS5E1 E3HS-1E1 * E3HS-DS5E1 E3HT-1E1 * E3HT-DS3E1 E3HC-1E1 * E3HC-DS3E1	Light-ON	<p>Incident light: ON (green bar), OFF (no bar)</p> <p>No incident light: OFF (no bar)</p> <p>Light indicator (red): ON (green bar), OFF (no bar)</p> <p>Output transistor: ON (green bar), OFF (no bar)</p> <p>Load (e.g., relay): Operate (green bar), Reset (no bar)</p> <p>Output voltage (e.g., logic): H (green bar), L (no bar)</p> <p><small>(Between brown and black)</small></p> <p><small>(Between blue and black)</small></p>	<p>Through-beam Receivers, Reflective Sensors</p>
E3HF-1E2 * E3HF-DS5E2 E3HS-1E2 * E3HS-DS5E2 E3HT-1E2 * E3HT-DS3E2 E3HC-1E2 * E3HC-DS3E2	Dark-ON	<p>Incident light: ON (green bar), OFF (no bar)</p> <p>No incident light: OFF (no bar)</p> <p>Light indicator (red): ON (green bar), OFF (no bar)</p> <p>Output transistor: ON (green bar), OFF (no bar)</p> <p>Load (e.g., relay): Operate (green bar), Reset (no bar)</p> <p>Output voltage (e.g., logic): H (green bar), L (no bar)</p> <p><small>(Between brown and black)</small></p> <p><small>(Between blue and black)</small></p>	

Through-beam Model Emitters

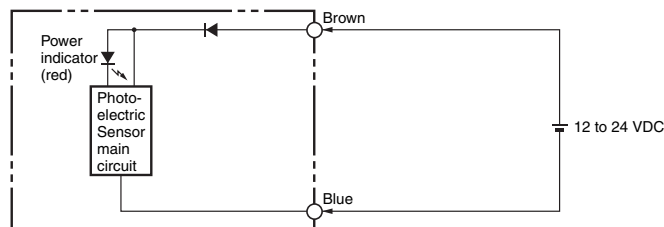

* Models numbers for Through-beam Sensors (E3H□-1E□) are for sets that include both the Emitter and Receiver. Emitter model numbers are in the form E3H□-1L (e.g., E3HF-1L). Receiver model numbers are in the form E3H□-1DE□ (e.g., E3HF-1DE1). Refer to *Ordering Information* to confirm model numbers for Emitter and Receivers.

Safety Precautions

⚠️ WARNINGS

This product is not designed or rated for ensuring safety of persons. Do not use it for such purpose.



Precautions for Correct Use

Do not use the product in atmospheres or environments that exceed product ratings.

● Mounting

Mounting

E3HF

- Use flat washers and spring washers on the M3 screws, and tighten the screws to a torque of 0.29 N·m max.

E3HC

Tightening torque: 0.2 N·m max.

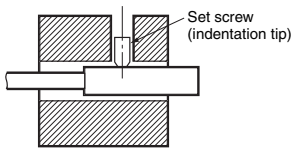

E3HT

- Do not tighten to a torque that exceeds the following values.

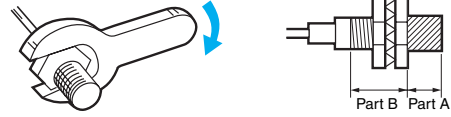

Note: The allowable torque depends on the distance from the tip of the head. Refer to the following table for the tightening torque for parts A and B. (Part A is the range between the tip of the head and the value given in the table. Part B includes the nut on the head, as shown in the figure above. If the edge of the nut enters the area of part A even slightly, apply the torque for part A.)

Model	Torque	Part A		Part B
	Dimension (mm)	Torque	Torque	Torque
E3HT-□□□	12	2 N·m	2.9 N·m	2.9 N·m

● Adjusting

Slit Adjustment

E3HF

- Slits with widths of 0.5, 1.0, and 2.0 mm are provided. Use these slits for adjustment when the diameter of the sensing object is 3.7 mm or less, and when it is necessary to correct for mutual interference.

(Unit: mm)

Dimensions

Unless otherwise specified, the tolerance class IT16 is used for dimensions in this data sheet.

Sensors

E3HF-1E□

Emitter

Receiver

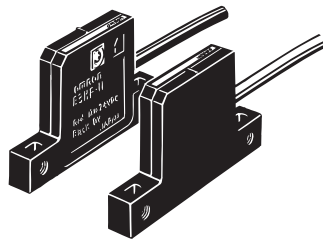

Emitter: E3HF-1L
Receiver: E3HF-1DE□

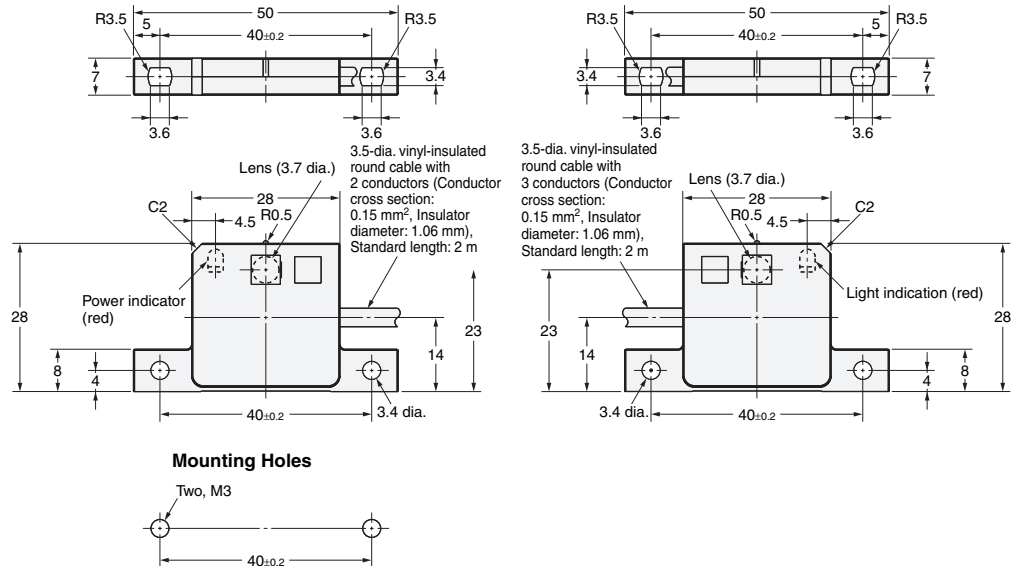

Note: Model numbers for Through-beam Sensors (E3HF-1E□) are for sets that include both the Emitter and Receiver.

The Emitter model number is E3HF-1L. Receiver model numbers are in the form E3HF-1DE□ (e.g., E3HF-1DE1). Refer to *Ordering Information* to confirm model numbers for Emitter and Receivers.

E3HF-DS5E□

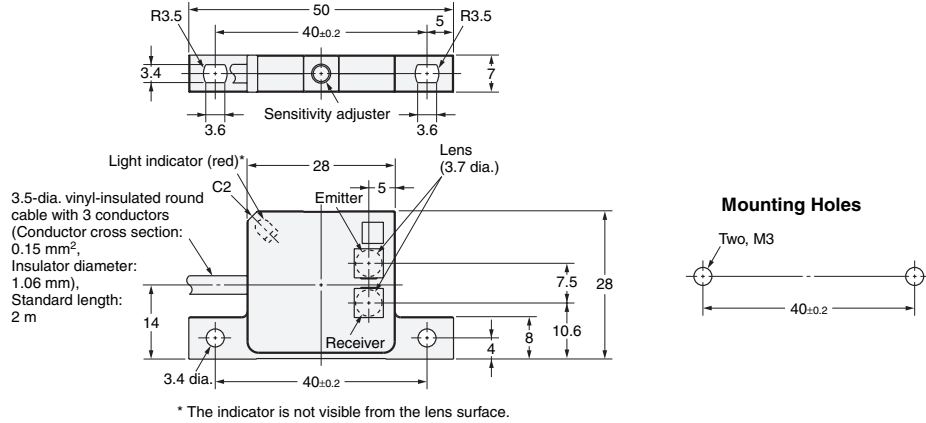
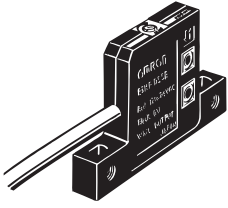

E3HS-1E□

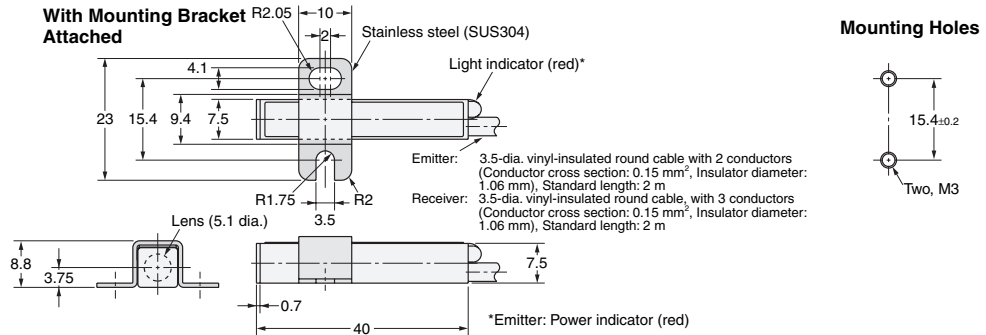
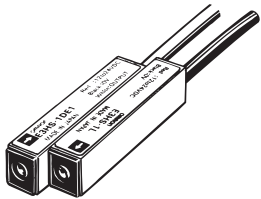

E3HS-DS5E□

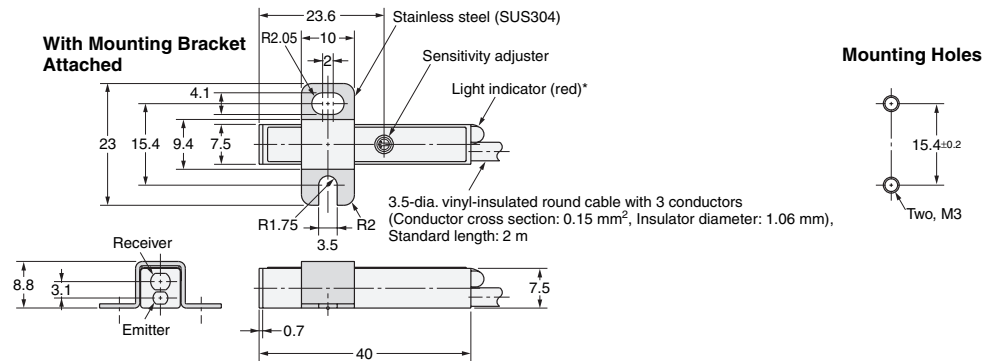
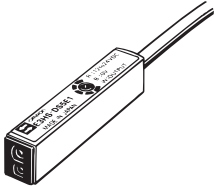

E3HT-1E□

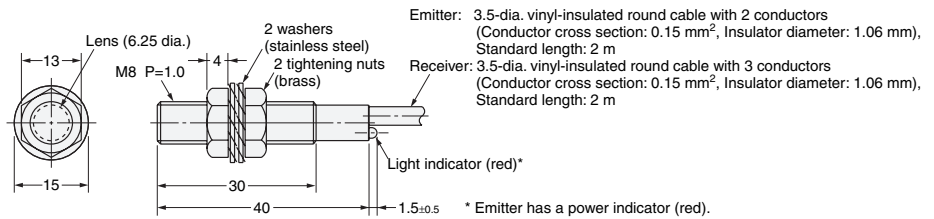
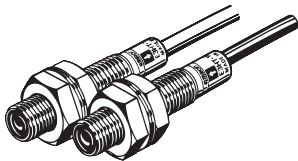

E3HT-DS3E□

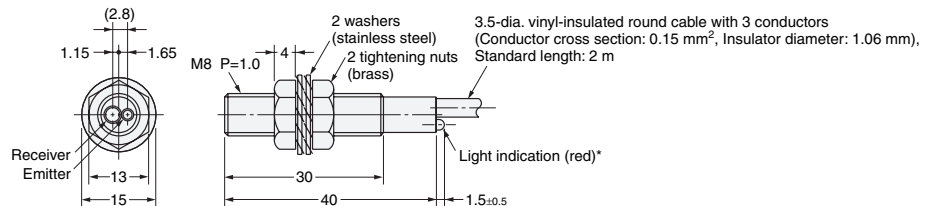
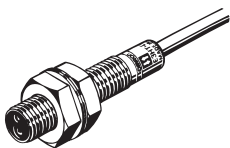

Note: Models numbers for Through-beam Sensors (E3H□-1E□) are for sets that include both the Emitter and Receiver. Emitter model numbers are in the form E3H□-1L (e.g., E3HS-1L). Receiver model numbers are in the form E3H□-1DE□ (e.g., E3HS-1DE1). Refer to *Ordering Information* to confirm model numbers for Emitter and Receivers.

E3HC-1E□

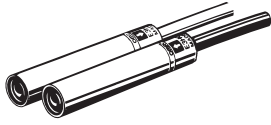

With Mounting Bracket Attached

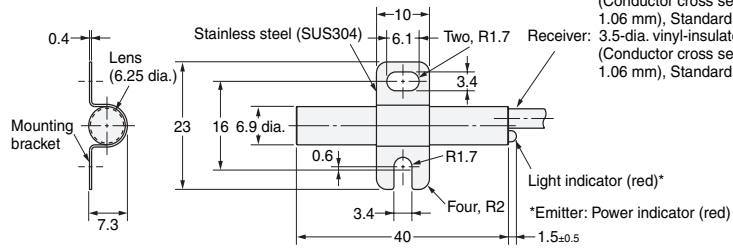

Mounting Holes

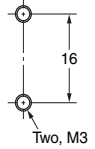

E3HC-DS3E□



With Mounting Bracket Attached

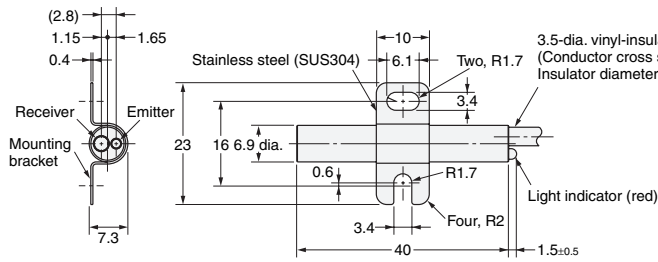

Mounting Holes

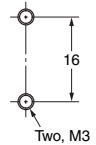

Note: Models numbers for Through-beam Sensors (E3HC-1E□) are for sets that include both the Emitter and Receiver.

The Emitter model number is E3HC-1L. Receiver model numbers are in the form E3HC-1DE□ (e.g., E3HC-1DE1). Refer to *Ordering Information* to confirm model numbers for Emitter and Receivers.

Accessories (Order Separately)

Seal-type Long Slit

(For E3HF-1E□)

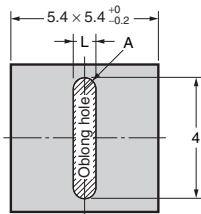

Name	L (mm)	A (mm)
Slit (A)	0.5	0.25
Slit (B)	1	0.5
Slit (C)	2	1

Note: Slits are adhesive and pressure-sensitive.
Peel off the seal, and attach the slit to the lens surface.

Material: Polyester film

*Provided with the Through-beam E3HF-1E□

Mounting Brackets

In the interest of product improvement, specifications are subject to change without notice.

Read and Understand This Catalog

Please read and understand this catalog before purchasing the products. Please consult your OMRON representative if you have any questions or comments.

Warranty and Limitations of Liability

WARRANTY

OMRON's exclusive warranty is that the products are free from defects in materials and workmanship for a period of one year (or other period if specified) from date of sale by OMRON.

OMRON MAKES NO WARRANTY OR REPRESENTATION, EXPRESS OR IMPLIED, REGARDING NON-INFRINGEMENT, MERCHANTABILITY, OR FITNESS FOR PARTICULAR PURPOSE OF THE PRODUCTS. ANY BUYER OR USER ACKNOWLEDGES THAT THE BUYER OR USER ALONE HAS DETERMINED THAT THE PRODUCTS WILL SUITABLY MEET THE REQUIREMENTS OF THEIR INTENDED USE. OMRON DISCLAIMS ALL OTHER WARRANTIES, EXPRESS OR IMPLIED.

LIMITATIONS OF LIABILITY

OMRON SHALL NOT BE RESPONSIBLE FOR SPECIAL, INDIRECT, OR CONSEQUENTIAL DAMAGES, LOSS OF PROFITS OR COMMERCIAL LOSS IN ANY WAY CONNECTED WITH THE PRODUCTS, WHETHER SUCH CLAIM IS BASED ON CONTRACT, WARRANTY, NEGLIGENCE, OR STRICT LIABILITY.

In no event shall the responsibility of OMRON for any act exceed the individual price of the product on which liability is asserted.

IN NO EVENT SHALL OMRON BE RESPONSIBLE FOR WARRANTY, REPAIR, OR OTHER CLAIMS REGARDING THE PRODUCTS UNLESS OMRON'S ANALYSIS CONFIRMS THAT THE PRODUCTS WERE PROPERLY HANDLED, STORED, INSTALLED, AND MAINTAINED AND NOT SUBJECT TO CONTAMINATION, ABUSE, MISUSE, OR INAPPROPRIATE MODIFICATION OR REPAIR.

Application Considerations

SUITABILITY FOR USE

OMRON shall not be responsible for conformity with any standards, codes, or regulations that apply to the combination of products in the customer's application or use of the products.

At the customer's request, OMRON will provide applicable third party certification documents identifying ratings and limitations of use that apply to the products. This information by itself is not sufficient for a complete determination of the suitability of the products in combination with the end product, machine, system, or other application or use.

The following are some examples of applications for which particular attention must be given. This is not intended to be an exhaustive list of all possible uses of the products, nor is it intended to imply that the uses listed may be suitable for the products:

- Outdoor use, uses involving potential chemical contamination or electrical interference, or conditions or uses not described in this catalog.
- Nuclear energy control systems, combustion systems, railroad systems, aviation systems, medical equipment, amusement machines, vehicles, safety equipment, and installations subject to separate industry or government regulations.
- Systems, machines, and equipment that could present a risk to life or property.

Please know and observe all prohibitions of use applicable to the products.

NEVER USE THE PRODUCTS FOR AN APPLICATION INVOLVING SERIOUS RISK TO LIFE OR PROPERTY WITHOUT ENSURING THAT THE SYSTEM AS A WHOLE HAS BEEN DESIGNED TO ADDRESS THE RISKS, AND THAT THE OMRON PRODUCTS ARE PROPERLY RATED AND INSTALLED FOR THE INTENDED USE WITHIN THE OVERALL EQUIPMENT OR SYSTEM.

PROGRAMMABLE PRODUCTS

OMRON shall not be responsible for the user's programming of a programmable product, or any consequence thereof.

Disclaimers

CHANGE IN SPECIFICATIONS

Product specifications and accessories may be changed at any time based on improvements and other reasons.

It is our practice to change model numbers when published ratings or features are changed, or when significant construction changes are made. However, some specifications of the products may be changed without any notice. When in doubt, special model numbers may be assigned to fix or establish key specifications for your application on your request. Please consult with your OMRON representative at any time to confirm actual specifications of purchased products.

DIMENSIONS AND WEIGHTS

Dimensions and weights are nominal and are not to be used for manufacturing purposes, even when tolerances are shown.

PERFORMANCE DATA

Performance data given in this catalog is provided as a guide for the user in determining suitability and does not constitute a warranty. It may represent the result of OMRON's test conditions, and the users must correlate it to actual application requirements. Actual performance is subject to the OMRON Warranty and Limitations of Liability.

ERRORS AND OMISSIONS

The information in this document has been carefully checked and is believed to be accurate; however, no responsibility is assumed for clerical, typographical, or proofreading errors, or omissions.

2010.9

In the interest of product improvement, specifications are subject to change without notice.

OMRON Corporation
Industrial Automation Company

<http://www.ia.omron.com/>

(c)Copyright OMRON Corporation 2010 All Right Reserved.



Компания «ЭлектроПласт» предлагает заключение долгосрочных отношений при поставках импортных электронных компонентов на взаимовыгодных условиях!

Наши преимущества:

- Оперативные поставки широкого спектра электронных компонентов отечественного и импортного производства напрямую от производителей и с крупнейших мировых складов;
- Поставка более 17-ти миллионов наименований электронных компонентов;
- Поставка сложных, дефицитных, либо снятых с производства позиций;
- Оперативные сроки поставки под заказ (от 5 рабочих дней);
- Экспресс доставка в любую точку России;
- Техническая поддержка проекта, помощь в подборе аналогов, поставка прототипов;
- Система менеджмента качества сертифицирована по Международному стандарту ISO 9001;
- Лицензия ФСБ на осуществление работ с использованием сведений, составляющих государственную тайну;
- Поставка специализированных компонентов (Xilinx, Altera, Analog Devices, Intersil, Interpoint, Microsemi, Aeroflex, Peregrine, Syfer, Eurofarad, Texas Instrument, Miteq, Cobham, E2V, MA-COM, Hittite, Mini-Circuits, General Dynamics и др.);

Помимо этого, одним из направлений компании «ЭлектроПласт» является направление «Источники питания». Мы предлагаем Вам помощь Конструкторского отдела:

- Подбор оптимального решения, техническое обоснование при выборе компонента;
- Подбор аналогов;
- Консультации по применению компонента;
- Поставка образцов и прототипов;
- Техническая поддержка проекта;
- Защита от снятия компонента с производства.



Как с нами связаться

Телефон: 8 (812) 309 58 32 (многоканальный)

Факс: 8 (812) 320-02-42

Электронная почта: org@eplast1.ru

Адрес: 198099, г. Санкт-Петербург, ул. Калинина, дом 2, корпус 4, литера А.