

Digital Timer H5CN

CSM_H5CN_DS_E_2_1

Miniature DIN-sized (48 x 48 mm) Quartz Timer with Abundant Series Versions

- Series version cover a wide range of rated times; 9.999 s, 99.99 s, 999.9 s, 99 min 59 s, and 99 hrs 59 min.
- Selection of elapsed time indication, remaining time indication, contact output, and solid-state output types to suit requirements.
- Power supply freely selectable within a range of 100 to 240 VAC, as well as 12 to 48 VDC.
- Certified for UL and CSA safety standards.



⚠ Refer to *Safety Precautions for All Timers*.
Refer to *Safety Precautions* on page 13

Model Number Structure

■ Model Number Legend

Note: This model number legend includes combinations that are not available. Before ordering, please check the *List of Models* on page 2 for availability.

H5CN- □□N□□
1 2 3 4 5

1. Display

- X: UP display (increments from 0 to the set time)
- Y: DOWN display (decrements from the set time to 0)

2. Rated time

- Z: 0.001 to 9.999 s
- A: 0.001 to 99.99 s
- B: 0.1 to 999.9 s
- C: 1 s to 99 min 59 s
- D: 1 min to 99 h 59 min

3. Output mode

- N: N mode (Power ON-delay)

4. Backup power supply function for memory protection

- None: Not provided
- M: Provided

5. Output type

- None: Contact output (SPDT)
- S: Solid-state output

Ordering Information

■ List of Models

Display type	UP display timer (increments from 0 to the set time)	DOWN display timer (decrements from the set time to 0)	UP display timer (increments from 0 to the set time)		
Output type	Contact output (SPDT)		Solid-state output		
Pin type	11-pin	8-pin			
Backup power supply function for memory protection	Uses external battery (lithium). (See notes 2 and 3.)	Not provided			
Supply voltage	100 to 240 VAC	100 to 240 VAC, 12 to 48 VDC	12 to 48 VDC		
Rated time	0.001 to 9.999 s	---	---	H5CN-XZNS	
	0.001 to 99.99 s	H5CN-XANM	H5CN-XAN	H5CN-YAN	H5CN-XANS
	0.1 to 999.9 s	H5CN-XBNM	H5CN-XBN	H5CN-YBN	---
	1 s to 99 min 59 s	H5CN-XCNM	H5CN-XCN	H5CN-YCN	---
	1 min to 99 h 59 min	H5CN-XDNM	H5CN-XDN	H5CN-YDN	---

Note: 1. Specify both the model number and supply voltage when ordering.

Example: H5CN-XAN 12 to 48 VDC

Supply voltage

2. The Y92S-20 Backup Battery (sold separately) provides power backup for memory protection during power failures for approximately 5 years (at 20°C). Always connect a battery to the H5CN-X□NM. For details on connection methods, refer to page 5.

3. The H5CN-X□NM does not support power resetting.

■ Accessories (Order Separately)

Name		Models
Flush Mounting Adapter		Y92F-30
Backup Battery		Y92S-20
Track Mounting/Front Connecting Socket	8-pin	P2CF-08
	11-pin	P2CF-11
Back Connecting Socket	8-pin	P3G-08
	11-pin	P3GA-11
Protective Cover	Hard Cover	Y92A-48B
	Soft Cover	Y92A-48D
Mounting Track	50 cm (l) × 7.3 mm (t)	PFP-50N
	1 m (l) × 7.3 mm (t)	PFP-100N
	1 m (l) × 16 mm (t)	PFP-100N2
End Plate		PFP-M
Spacer		PFP-S

Specifications

■ Ratings

Item	Contact output	Solid-state output
Rated supply voltage	100 to 240 VAC (50/60 Hz), 12 to 48 VDC (permissible ripple: 20% max.) (See note 1.)	12 to 48 VDC (permissible ripple: 20% max.)
Operating voltage range	85% to 110% of rated supply voltage	
Power consumption	Approx. 12 VA at 240 VAC, 50 Hz Approx. 2.5 W at 48 VDC	Approx. 2.5 W at 48 VDC
Mounting method	Surface mounting or flush mounting	
Display	7-segment LEDs (8-mm-high characters), UP indicator	
Input method	Contact open and short-circuit input	Open-collector transistor ON/OFF input
Resetting system and gate input	Reset by power-OFF (See note 2.): min. power OFF time: 0.5 s External reset or gate (common to contact and solid-state inputs): min. reset input signal width: 0.02 s; residual voltage: 2 V max.	
Output mode	N mode (Power ON-delay)	
Control outputs	SPDT: 3 A at 250 VAC, resistive load ($\cos\phi = 1$)	Open collector: 100 mA max. at 30 VDC max.
Ambient temperature	Operating: -10°C to 55°C (with no icing or condensation) Storage: -25°C to 65°C (with no icing or condensation)	
Ambient humidity	Operating: 35% to 85%	
Case color	Light gray (Munsell 5Y7/1)	

Note: 1. Models with memory backup function are available only for AC power.

2. The H5CN-X□NM cannot be reset by turning OFF the power.

■ Characteristics

Accuracy of operating time	±0.01% ±0.05 s max. (see note 1), ±0.005% ±0.03 s max. (see note 2) (see note 3)
Setting error	
Influence of voltage	
Influence of temperature	
Insulation resistance	100 MΩ min. (at 500 VDC) (between current-carrying terminal and exposed non-current carrying metal parts, between power supply circuit and control output circuit)
Dielectric strength	2,000 VAC, 50/60 Hz for 1 min (between current-carrying terminal and exposed non-current-carrying metal parts, between power supply circuit and control output circuit)
Impulse withstand voltage	6 kV (between power supply terminal) 6 kV (between current-carrying terminal and exposed non-current carrying metal parts)
Noise immunity	Square-wave noise by noise simulator AC: ±2 kV (between power supply terminals) DC: ±480 V (between power supply terminals), ±500 V (between input terminals)
Static immunity	Malfunction: 8 kV
Vibration resistance	Destruction: 10 to 55 Hz with 0.75-mm single amplitude each in 3 directions for 2 hours each Malfunction: 10 to 55 Hz with 0.5-mm single amplitude each in 3 directions for 10 minutes each
Shock resistance	Destruction: 300 m/s ² 3 times each in 6 directions Malfunction: 100 m/s ² 3 times each in 6 directions
Life expectancy	Mechanical: 10,000,000 operations min. Electrical: 100,000 operations min. (3 A at 250 VAC, resistive load)
Approved standards	UL508, CSA C22.2 No. 14
Weight	Approx. 200 g

Note: 1. When timer operation is started by power application.

2. When timer operation is started after a reset input has been applied.

3. These values represent the total accuracy of the timer including the repeat accuracy, setting error, and variation due to voltage and temperature changes. Note that they also comprise errors due to the rise time of the power source and the operating times of the internal and output circuits.

Life-test Curve (Reference Values)

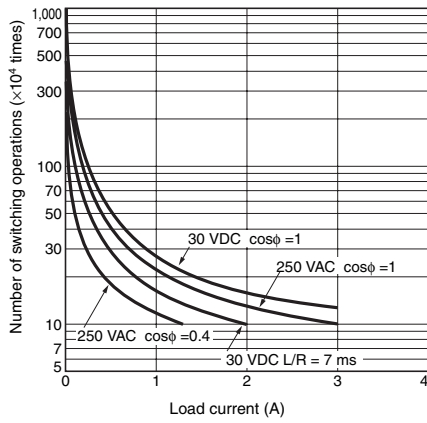

A maximum current of 0.15A can be switched at 125 VDC ($\cos\phi = 1$)

Maximum current of 0.1 A can be switched if L/R is 7 ms. In both cases, a life of 100,000 operations can be expected. The minimum applicable load is 10 mA at 5 VDC (failure level: P reference value).

Connections

■ Block Diagram

H5CN-□□N (without Backup Power for Memory Protection)

Using an AC Power Supply (Contact Outputs)

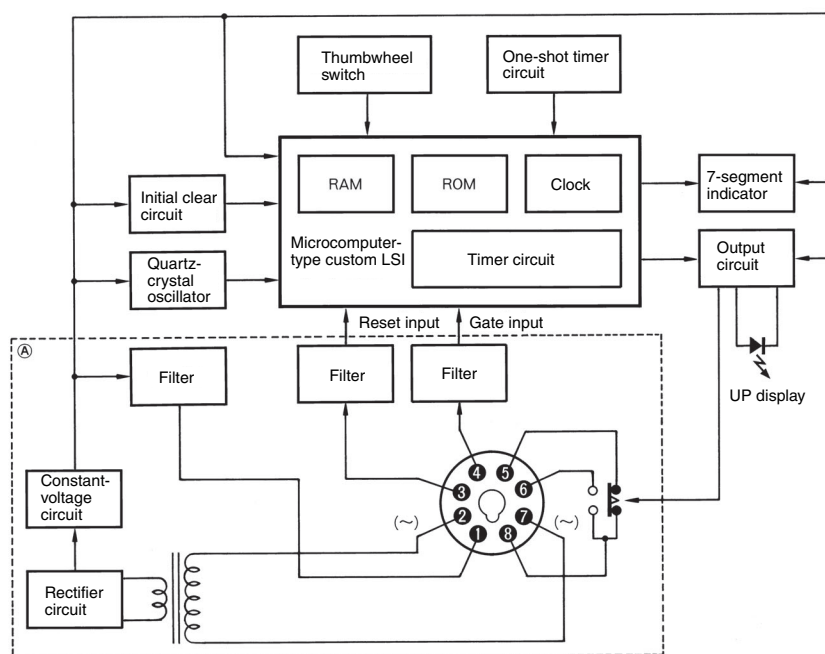

- Note:**
1. If the reset input is short-circuited (between terminals ① and ③), immediately the count circuit is reset to 0 and the control output relay is reset to OFF. The timer starts as soon as the reset input is opened (between terminals ① and ③).
 2. If the gate input is short-circuited (between terminals ① and ④), the count circuit stops immediately. The timer then restarts as soon as the gate input is opened (between terminals ① and ④).

Using a DC Power Supply (Solid-state Outputs)

Note: The following block diagram shows the differences for the equivalent section indicated by "A" in the above block diagram.

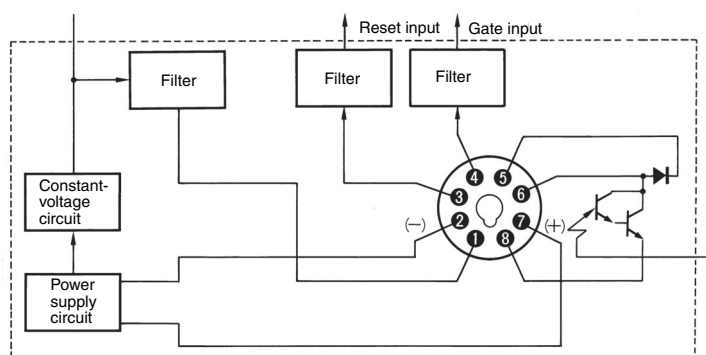

Note: Terminals ① and ② are internally short-circuited.

H5CN-X□NM (with Backup Power for Memory Protection)

Note: Be sure to install a Backup Battery (sold separately).

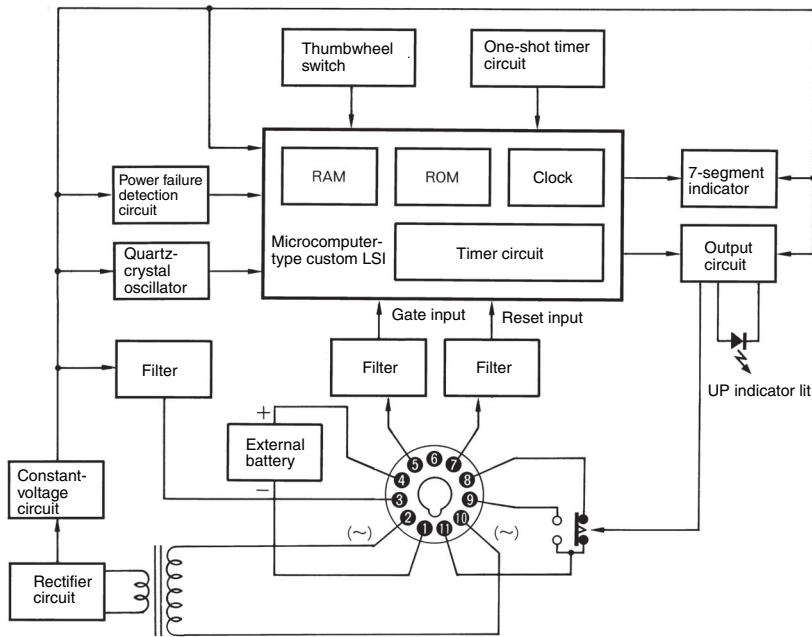

- Note:**
1. If the reset input is short-circuited (between terminals ③ and ⑦), immediately the count circuit is initialized and the control output relay is reset to OFF. The timer starts as soon as the reset input is opened (between terminals ③ and ⑦).
 2. If the gate input is short-circuited (between terminals ③ and ⑤), the count circuit stops immediately. The timer then restarts as soon as the gate input is opened (between terminals ③ and ⑤).

Installation

■ Connections

1. Battery Connection (H5CN-X□NM Only)

Model with Backup Power for Memory Protection

Connect the Y92S-20 Backup Battery between terminals ① and ④, making sure the polarities are correct.

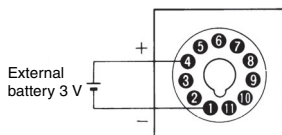

2. Power Supply Connection

Model without Backup Power for Memory Protection

Connect the timer so that the required supply voltage can be applied across terminals ② and ⑦. (Make sure that the polarity of the DC power supply is correct.)

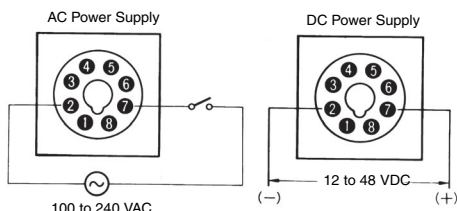

Model with Backup Power for Memory Protection (H5CN-X□NM)

Connect the timer so that the required supply voltage can be applied across terminals ② and ⑩.

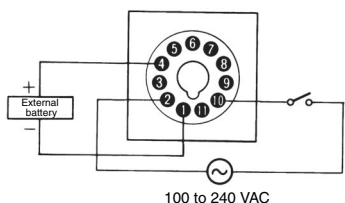

3. Connection of Load Circuit (Control Output)

Model without Backup Power for Memory Protection

Contact Output Type

Internal Circuit of Control Output Contacts

Terminals ⑤, ⑥, and ⑧ are for control output contacts.

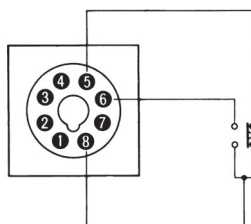

Connecting of Load Circuit

Load 1 connected in series with NO contact (between terminals ⑥ and ⑧) is normally open, and the load circuit voltage will be applied after the lapse of the set time. The load circuit voltage is normally applied to load 2 connected in series with NC contact (between terminals ⑤ and ⑧), which will be open after the lapse of the set time.

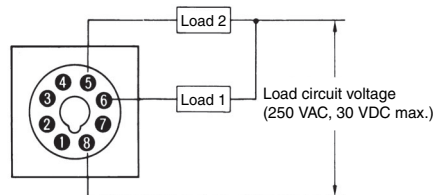

Note: The maximum load current is 3 A (resistive load).

Solid-state Output Type

Internal Circuit of Control Output

Terminals ⑥ and ⑧ are an open collector output. A diode is internally connected between terminals ⑤ and ⑥ to absorb counterelectromotive force that occurs when an inductive load is connected.

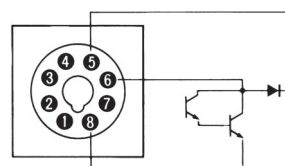

Connection of Load Circuit

Voltage is applied to the load after the set time has lapsed.

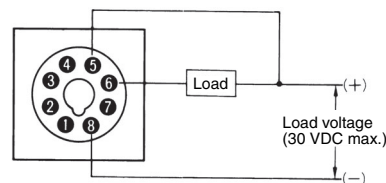

Note: The maximum load current is 100 mA.

Model with Backup Power for Memory Protection (H5CN-X□NM)

Contact Output Type

Internal Circuit of Control Output Contacts

Terminal ⑧, ⑨, and ⑩ are for control output contacts.

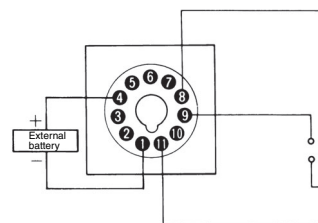

Connection of Load Circuit

Load 1 connected in series with NO contact (between terminals ⑨ and ⑩) is normally open, and the load circuit voltage will be applied to it after the lapse of the set time. The load circuit voltage is normally applied to load 2 connected in series with NC contact (between terminals ⑧ and ⑩), which will be open after the lapse of the set time.

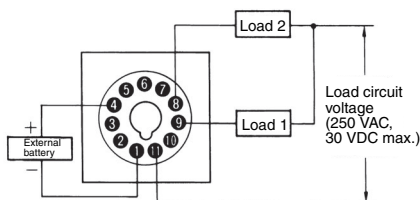

Note: The maximum load current is 3 A (resistive load).

4. Connection of Reset Input

Connection of the reset input contact or an open collector transistor between terminals ① and ③ (between terminals ③ and ⑦ for models with backup power for memory protection) permits the timer to reset when contact is made or the transistor turns ON. Use of a high-reliability gold-plated contact is recommended for the reset input. For the reset input transistor, select the one satisfying the following electrical ratings:

$V_{CEO} = 20\text{ V min.}$

$IC = 50\text{ mA min.}$

I_{CEO} (leakage current) = 0.5 $\mu\text{A max.}$

$V_{CE(sat)}$ (residual voltage) = 2 V max.

Model without Backup Power for Memory Protection

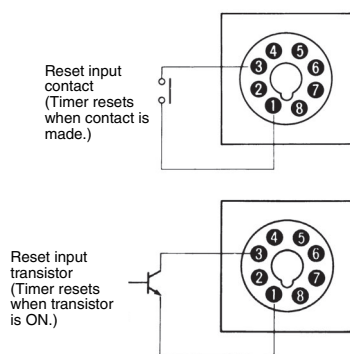

Model with Backup Power for Memory Protection (H5CN-X□NM)

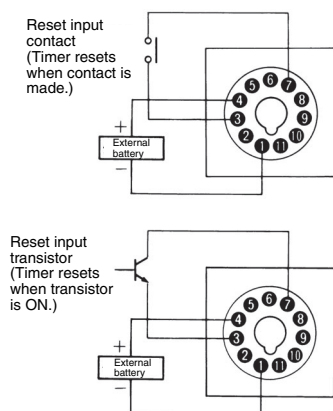

5. Connection of Gate Input

Connection of the gate input contact or an open collector transistor between terminals ① and ④ (between terminals ③ and ⑤ for models with backup power for memory protection) permits the timer to stop operation while contact is made or the transistor turns ON. Use of a high-reliability gold-plated contact is recommended for the gate input. For the gate input transistor, select the one satisfying the following electrical ratings:

$V_{CEO} = 20\text{ V min.}$

$IC = 50\text{ mA min.}$

I_{CEO} (leakage current) = 0.1 mA max.

$V_{CE(sat)}$ (residual voltage) = 2 V max.

Use a gate input contact with a short bounce time because the contact bounce time causes an error in the operate time of the timer for a period equalling the bounce time.

Model without Backup Power for Memory Protection

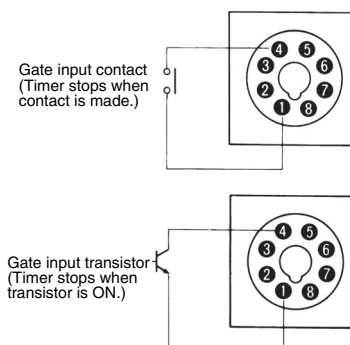

Model with Backup Power for Memory Protection (H5CN-X□NM)

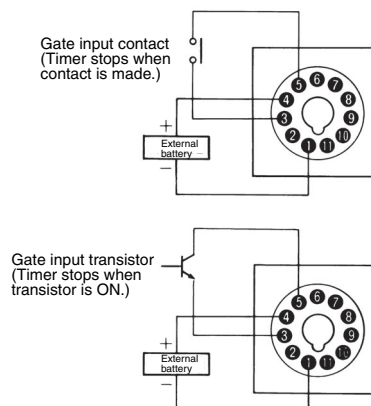

6. Battery Connections when Using Backup Power for Memory Protection

Always connect a battery when using models with backup power for memory protection (H5CN-X□NM). Any 3-V battery can be used, but the backup time will depend on the capacity of the battery.

When using the Unit for the first time after purchase, apply power and reset the Unit once before using it. When power is turned ON for the first time, outputs may be produced at the same time, so do not connect the output terminals.

When connecting the battery using a Socket (P2CF-11 or P3GA-11), check the terminal numbers on the Socket and connect the positive side of the battery to terminal ④ and the negative side to terminal ①.

Operation

■ Timing Chart

Digital Display

UP Display

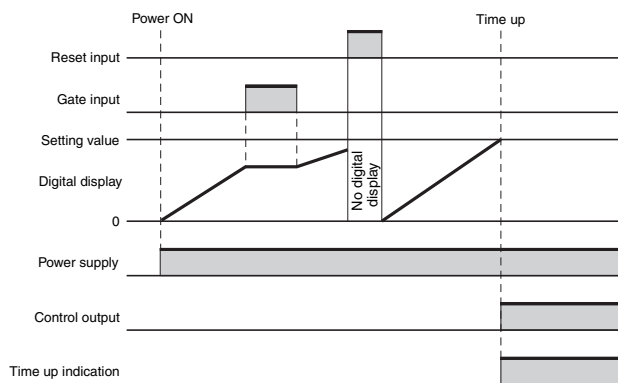

DOWN Display

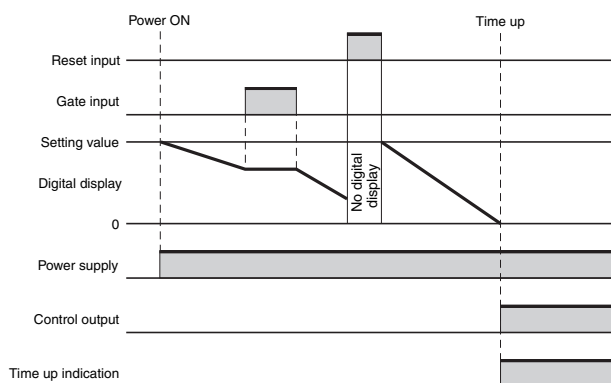

Dimensions

Note: All units are in millimeters unless otherwise indicated.

■ Dimensions without Flush Mounting Adapter

H5CN-X□N/Y□N/X□NS (Flush Mounting/Surface Mounting Models)

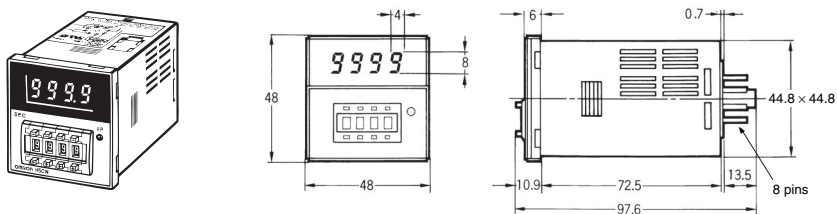

H5CN-X□NM (Flush Mounting/Surface Mounting Models)

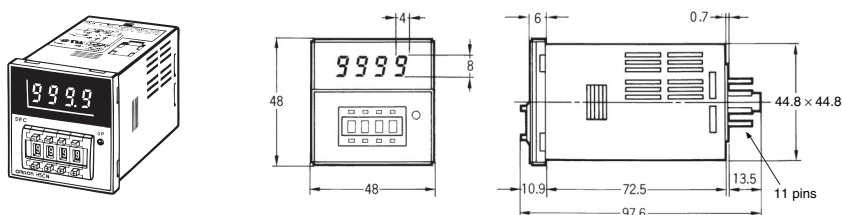

■ Dimensions with Flush Mounting Adapter

H5CN-X□N/Y□N/X□NS (Adapter Ordered Separately)

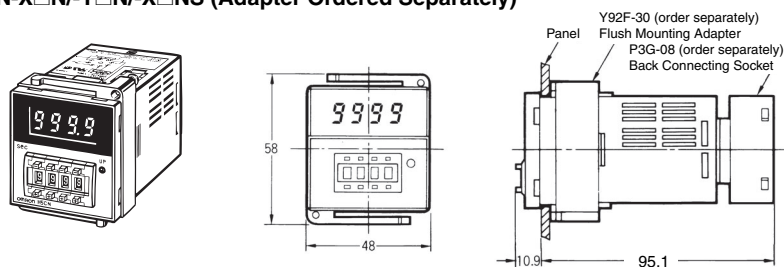

Panel Cutout

The standard panel cutout is as below.
(Panel cutout conforms to DIN 43700.)

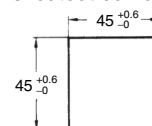

Gang-mounting of more than 2 units (horizontally)

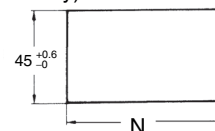

H5CN-X□NM (Adapter Ordered Separately)

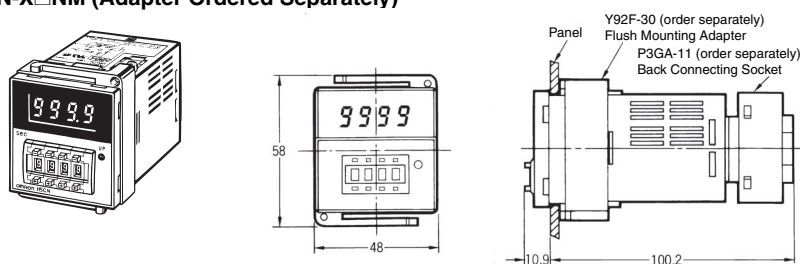

- Note:**
1. Panel thickness: 1 to 5 mm
 2. When gang-mounting the Unit, the orientation of the Adapter must be changed depending on whether Units are mounted horizontally or vertically.
 3. No cover:
 $N = (48n - 2.5)^{+1/-0}$
 With hard cover:
 $N = \{48n - 2.5 + (n - 1) \times 3\}^{+1/-0}$

■ Dimensions with Front Connecting Socket

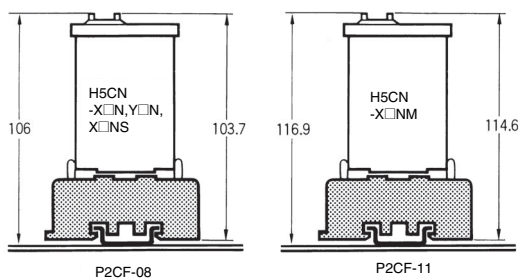

Flush Mounting

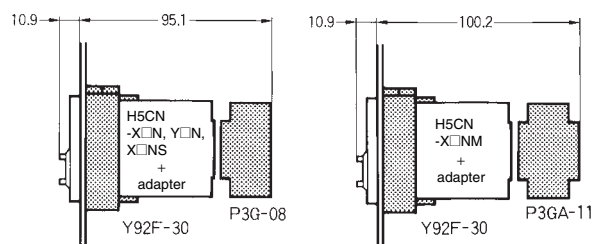

Note: These dimensions vary with the kind of DIN track (reference value).

■ Accessories (Order Separately)

Note: All units are in millimeters unless otherwise indicated.

Track Mounting/Front Connecting Socket

P2CF-08

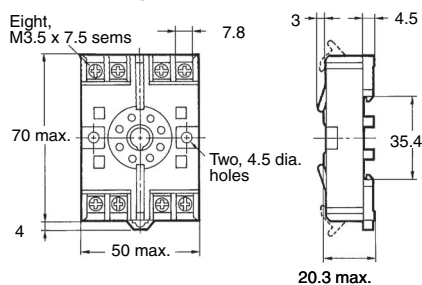
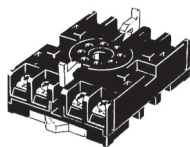

Terminal Arrangement/ Internal Connections (Top View)

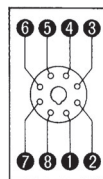

Surface Mounting Holes

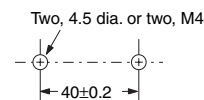

Track Mounting/Front Connecting Socket

P2CF-11

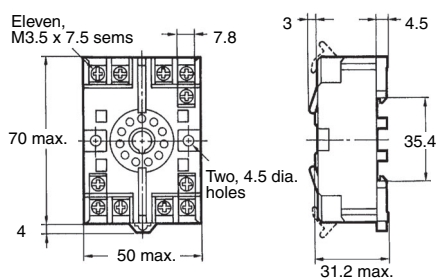
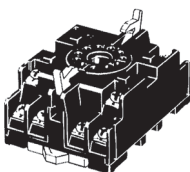

Terminal Arrangement/ Internal Connections (Top View)

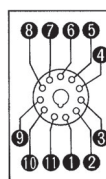

Surface Mounting Holes

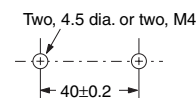

Back Connecting Socket

P3G-08

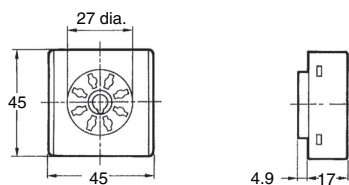
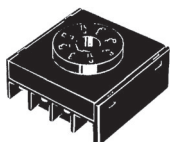

Terminal Arrangement/ Internal Connections (Bottom View)

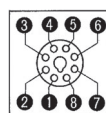

P3GA-11

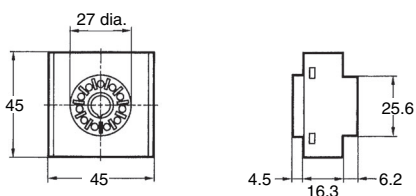
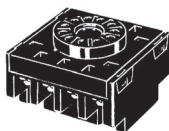

Terminal Arrangement/ Internal Connections (Bottom View)

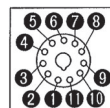

Backup Battery Y92S-20

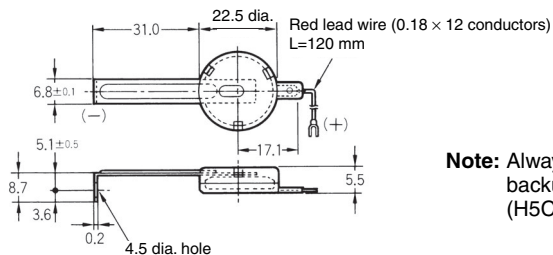
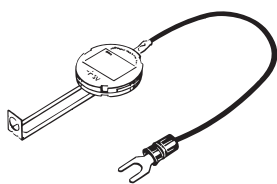

Note: Always connect a battery to models with backup power for memory protection (H5CN-□M).

Soft Cover Y92A-48D (See note 1.)

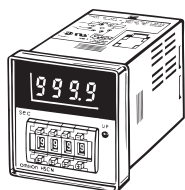

Hard Cover Y92A-48B (See note 2.)

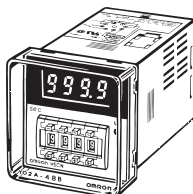

- Note:**
1. The soft protective cover allows the set value to be set by depressing the thumbwheel switches through it. It may be, however, difficult to make setting changes of the Timer with the Y92A-48D Protective Cover attached, which must be taken into consideration before using the Y92A-48D Protective Cover.
 2. The hard protective cover prevents the set value from being altered due to accidental contact with the push type thumbwheel switch.

Flush Mounting Adapter Y92F-30

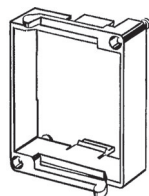

Mounting Track PFP-100N, PFP-50N

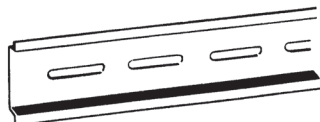

PFP-100N2

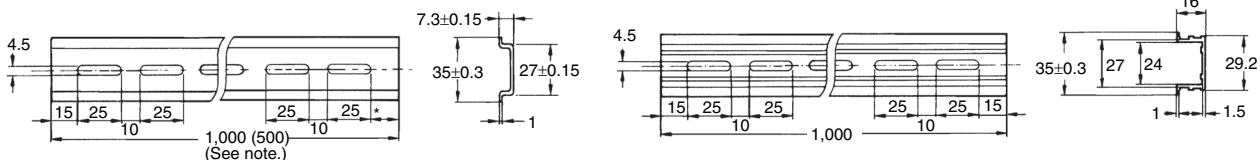
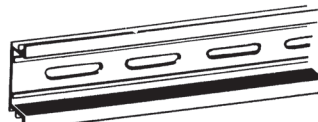

Note: The values shown in parentheses are for the PFP-50N.

End Plate PFP-M

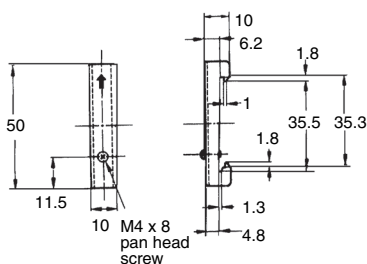
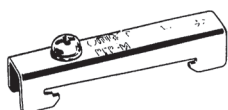

Spacer PFP-S

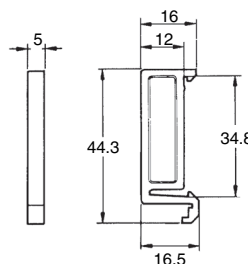
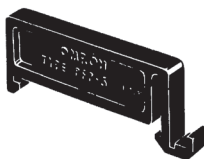

Safety Precautions

Refer to *Safety Precautions for All Timers*.

⚠ WARNING

The Y92S-20 Backup Battery used for the H5CN-X□NM is a lithium battery (non-explosion-proof). Do not short-circuit the positive and negative sides of the battery, recharge or disassemble the battery, deform the battery under pressure, or dispose of the battery in fire. Doing so may occasionally cause the battery to burst, ignite, or leak. Use only the specified battery. Otherwise, the battery may leak or burst, occasionally causing damage to the equipment or minor injury.

■ Precautions for Correct Use

Battery Connections when Using Backup Power for Memory Protection

Always connect a battery when using models with backup power for memory protection. Any 3-V battery can be used, but the backup time will depend on the capacity of the battery. When using the Unit for the first time after purchase, apply power and reset the Unit once before using it. When power is turned ON for the first time, outputs may be produced at the same time, so do not connect the output terminals.

If a power interruption continues for 10 minutes or more when a battery is not connected, the count value and displays may be meaningless, and outputs may be produced unpredictably even if the power supply recovers. If this happens, apply power to the reset input once before using the Unit further. (The Unit can be used after turning ON the reset input, regardless of whether a battery is connected or not.)

Regular battery replacement (every 4 to 5 years) is recommended. The life of the battery depends on the frequency of power failures.

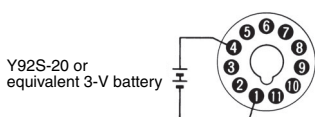

Connection Methods

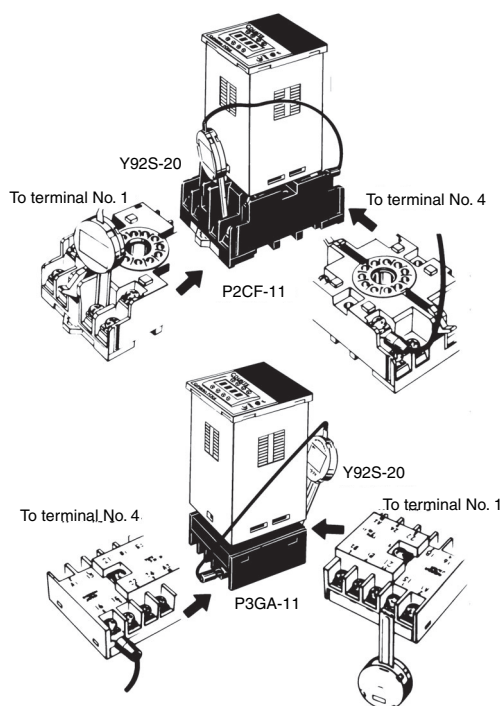

Setting of Operating Time

Time Setting Range

Setting range	Models
0.001 to 9.999 s	H5CN-□Z□
0.01 to 99.99 s	H5CN-□A□
0.1 to 999.9 s	H5CN-□B□
1 s to 99 min 59 s	H5CN-□C□
1 min to 99 h 59 min	H5CN-□D□

- The H5CN Timer is capable of reading the input data at any time during normal operation. This means that the set time can be changed during power application. This feature sets back the output from the timer by temporarily setting the longer time or quickens the output by setting the shorter time. During normal operation, the set time may be accidentally changed by touching a thumbwheel switch. To prevent this possibility, use the optional Y92A-48□ Protective Cover.
- When the set time is all zeroes (e.g., 000.0 s or 00 h 00 min), there will be a momentary control output upon power application, which can be used to check normal output. When changing the set time during normal operation, pay special attention not to alter the set value to this all zeroes.
- When changing the set time while power is being supplied, an inadequate push of the thumbwheel switches will display two numbers in one digital display window, causing the operating time to drift widely. Therefore, press the thumb-wheel switches surely. Take particular care when the other three digits are all zeroes, because the improper setting of the fourth switch to create four zeroes will cause an instantaneous output.

Undesirable Setting

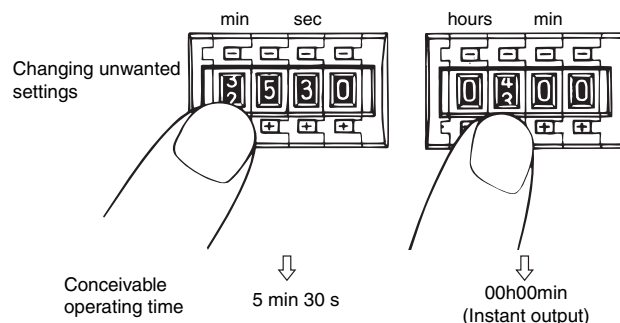

- Take particular care with the H5CN-□Z□, which is capable of setting in 1/1000th of a second because there is an error of between 0.03 to 0.05 ms. (Repeat accuracy is 1 to 2 ms.)

Operation Examples

- During Incremental Operation**
If the set value is changed to a value higher than the currently displayed present value, the timer will time out for the new set value.
- During Decremental Operation**
When the set value changes, the difference between the new set value and old set value will be added or subtracted from the present value.

Example:

Old set value		New set value
200 s	->	100 s
Present value (before changing setting)		Present set value (after changing setting)
160 s	->	60 s

Power Supply

Leave the power supply OFF for at least 0.5 s before turning it back ON (power supply reset).

Inputs and Outputs

- Do not apply voltage externally to input terminals ①, ③, and ④.
- When using contacts for the reset input and gate input, use gold-plated contacts with good contact reliability. Use gate input contacts with short contact bounce (chattering).

Operation during Power Failures

- When Units without backup power for memory protection are used, the timer status during momentary power failures is as shown in the following diagrams.

A. Power Failure of 0.01 s Max.

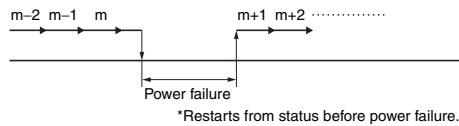

B. Power Failure of 0.5 s Min.

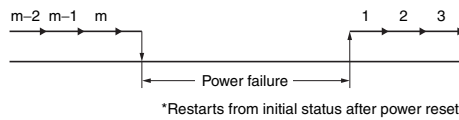

C. Power Failure of 0.01 to 0.5 s Max.

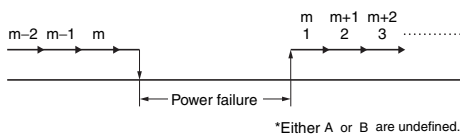

- Units with backup power for memory protection will restart from the status before the power failure as shown in example A, regardless of the length of time of the power failure.

ALL DIMENSIONS SHOWN ARE IN MILLIMETERS.

To convert millimeters into inches, multiply by 0.03937. To convert grams into ounces, multiply by 0.03527.

In the interest of product improvement, specifications are subject to change without notice.

Read and Understand This Catalog

Please read and understand this catalog before purchasing the products. Please consult your OMRON representative if you have any questions or comments.

Warranty and Limitations of Liability

WARRANTY

OMRON's exclusive warranty is that the products are free from defects in materials and workmanship for a period of one year (or other period if specified) from date of sale by OMRON.

OMRON MAKES NO WARRANTY OR REPRESENTATION, EXPRESS OR IMPLIED, REGARDING NON-INFRINGEMENT, MERCHANTABILITY, OR FITNESS FOR PARTICULAR PURPOSE OF THE PRODUCTS. ANY BUYER OR USER ACKNOWLEDGES THAT THE BUYER OR USER ALONE HAS DETERMINED THAT THE PRODUCTS WILL SUITABLY MEET THE REQUIREMENTS OF THEIR INTENDED USE. OMRON DISCLAIMS ALL OTHER WARRANTIES, EXPRESS OR IMPLIED.

LIMITATIONS OF LIABILITY

OMRON SHALL NOT BE RESPONSIBLE FOR SPECIAL, INDIRECT, OR CONSEQUENTIAL DAMAGES, LOSS OF PROFITS OR COMMERCIAL LOSS IN ANY WAY CONNECTED WITH THE PRODUCTS, WHETHER SUCH CLAIM IS BASED ON CONTRACT, WARRANTY, NEGLIGENCE, OR STRICT LIABILITY.

In no event shall the responsibility of OMRON for any act exceed the individual price of the product on which liability is asserted.

IN NO EVENT SHALL OMRON BE RESPONSIBLE FOR WARRANTY, REPAIR, OR OTHER CLAIMS REGARDING THE PRODUCTS UNLESS OMRON'S ANALYSIS CONFIRMS THAT THE PRODUCTS WERE PROPERLY HANDLED, STORED, INSTALLED, AND MAINTAINED AND NOT SUBJECT TO CONTAMINATION, ABUSE, MISUSE, OR INAPPROPRIATE MODIFICATION OR REPAIR.

Application Considerations

SUITABILITY FOR USE

OMRON shall not be responsible for conformity with any standards, codes, or regulations that apply to the combination of products in the customer's application or use of the products.

At the customer's request, OMRON will provide applicable third party certification documents identifying ratings and limitations of use that apply to the products. This information by itself is not sufficient for a complete determination of the suitability of the products in combination with the end product, machine, system, or other application or use.

The following are some examples of applications for which particular attention must be given. This is not intended to be an exhaustive list of all possible uses of the products, nor is it intended to imply that the uses listed may be suitable for the products:

- Outdoor use, uses involving potential chemical contamination or electrical interference, or conditions or uses not described in this catalog.
- Nuclear energy control systems, combustion systems, railroad systems, aviation systems, medical equipment, amusement machines, vehicles, safety equipment, and installations subject to separate industry or government regulations.
- Systems, machines, and equipment that could present a risk to life or property.

Please know and observe all prohibitions of use applicable to the products.

NEVER USE THE PRODUCTS FOR AN APPLICATION INVOLVING SERIOUS RISK TO LIFE OR PROPERTY WITHOUT ENSURING THAT THE SYSTEM AS A WHOLE HAS BEEN DESIGNED TO ADDRESS THE RISKS, AND THAT THE OMRON PRODUCTS ARE PROPERLY RATED AND INSTALLED FOR THE INTENDED USE WITHIN THE OVERALL EQUIPMENT OR SYSTEM.

PROGRAMMABLE PRODUCTS

OMRON shall not be responsible for the user's programming of a programmable product, or any consequence thereof.

Disclaimers

CHANGE IN SPECIFICATIONS

Product specifications and accessories may be changed at any time based on improvements and other reasons.

It is our practice to change model numbers when published ratings or features are changed, or when significant construction changes are made. However, some specifications of the products may be changed without any notice. When in doubt, special model numbers may be assigned to fix or establish key specifications for your application on your request. Please consult with your OMRON representative at any time to confirm actual specifications of purchased products.

DIMENSIONS AND WEIGHTS

Dimensions and weights are nominal and are not to be used for manufacturing purposes, even when tolerances are shown.

PERFORMANCE DATA

Performance data given in this catalog is provided as a guide for the user in determining suitability and does not constitute a warranty. It may represent the result of OMRON's test conditions, and the users must correlate it to actual application requirements. Actual performance is subject to the OMRON Warranty and Limitations of Liability.

ERRORS AND OMISSIONS

The information in this document has been carefully checked and is believed to be accurate; however, no responsibility is assumed for clerical, typographical, or proofreading errors, or omissions.

2008.11

In the interest of product improvement, specifications are subject to change without notice.

OMRON Corporation
Industrial Automation Company

<http://www.ia.omron.com/>

(c)Copyright OMRON Corporation 2008 All Right Reserved.

Mouser Electronics

Authorized Distributor

Click to View Pricing, Inventory, Delivery & Lifecycle Information:

Omron:

[H5CN-XBN AC100-240](#) [H5CN-XDN AC100-240](#) [Y92S-20](#) [H5CN-XAN AC100-240](#) [H5CN-XAN DC12-48](#) [H5CN-XBN DC12-48](#) [H5CN-XCN AC100-240](#) [H5CN-XCN DC12-48](#) [H5CN-XCNM DC24](#) [H5CN-XDNM AC100-240](#) [H5CN-XZNS AC100-240](#) [H5CN-YAN AC100-240](#) [H5CN-YBN AC100-240](#) [H5CN-YDN AC100-240](#) [H5CN-YDN DC12-48](#)



Компания «ЭлектроПласт» предлагает заключение долгосрочных отношений при поставках импортных электронных компонентов на взаимовыгодных условиях!

Наши преимущества:

- Оперативные поставки широкого спектра электронных компонентов отечественного и импортного производства напрямую от производителей и с крупнейших мировых складов;
- Поставка более 17-ти миллионов наименований электронных компонентов;
- Поставка сложных, дефицитных, либо снятых с производства позиций;
- Оперативные сроки поставки под заказ (от 5 рабочих дней);
- Экспресс доставка в любую точку России;
- Техническая поддержка проекта, помощь в подборе аналогов, поставка прототипов;
- Система менеджмента качества сертифицирована по Международному стандарту ISO 9001;
- Лицензия ФСБ на осуществление работ с использованием сведений, составляющих государственную тайну;
- Поставка специализированных компонентов (Xilinx, Altera, Analog Devices, Intersil, Interpoint, Microsemi, Aeroflex, Peregrine, Syfer, Eurofarad, Texas Instrument, Miteq, Cobham, E2V, MA-COM, Hittite, Mini-Circuits, General Dynamics и др.);

Помимо этого, одним из направлений компании «ЭлектроПласт» является направление «Источники питания». Мы предлагаем Вам помощь Конструкторского отдела:

- Подбор оптимального решения, техническое обоснование при выборе компонента;
- Подбор аналогов;
- Консультации по применению компонента;
- Поставка образцов и прототипов;
- Техническая поддержка проекта;
- Защита от снятия компонента с производства.



Как с нами связаться

Телефон: 8 (812) 309 58 32 (многоканальный)

Факс: 8 (812) 320-02-42

Электронная почта: org@eplast1.ru

Адрес: 198099, г. Санкт-Петербург, ул. Калинина, дом 2, корпус 4, литера А.