

# DS Series Interlock Pushbutton Switches

## Features/Benefits

- Snap-in mounting
- Reliable snap action mechanism
- Latch or momentary
- RoHS compliant
- Halogen free material

## Typical Applications

- Interlock switch
- Detection switch
- Circuit interrupt



## Specifications

FUNCTION: Single pole double throw / Double pole double throw  
MOUNTING TYPE: Snap in style

## Electrical

ELECTRICAL LIFE: see ratings chart below  
DIELECTRIC STRENGTH: 1500 V (50-60 Hz @ sea level)  
INSULATION RESISTANCE: 100 M  $\Omega$  min.  
INITIAL CONTACT RESISTANCE: 30 milli-ohms

## Materials

HOUSING, COVER, ACTUATOR, KNOB: PA 66/6 halogen free, UL94V-0  
NO & NC FIXED TERMINALS: Copper alloy  
COMMON TERMINALS: Copper alloy, silver plate  
CONTACTS: Silver alloy / F5 rating gold plated over silver alloy  
RETURN SPRINGS: Stainless steel

## Operating Environment

OPERATING TEMPERATURE: -40°C to +85°C

**NOTE:** Specifications and materials listed above are for switches with standard options. For information on specific and custom switches, please contact Customer Service.

## Build-A-Switch

To order, simply select desired option from each category and place in the appropriate box.

<p><b>Designation</b></p> <p><b>DS</b> DS Series</p> <p><b>Number of Poles</b></p> <p><b>1</b> SPDT <b>2</b> DPDT</p> <p><b>Rating</b></p> <p><b>F5</b> 0.1 (0.5)A @ 125/250 V AC 50/60 Hz 50E3 0.1A G.P. @ 125/250 V AC 50/60 Hz 50E3</p> <p><b>F7</b> 0.1 (0.5)A @ 125/250 V AC 50/60 Hz 10E4 0.1A G.P. @ 125/250 V AC 50/60 Hz 10E4</p> <p><b>D6</b> 10 (4)A @125/250 V AC 50/60 Hz 50E3 10A G.P. @ 125 / 250 V AC 1/3HP @ 125/250 V AC 50/60 Hz 10E3</p> <p><b>D7*</b> 16A G.P. @125/250 V AC 3/4HP 125/250 V AC 50/60 Hz 10E3 16 (6) A @125/250 V AC 50/60 Hz 10E3 * Note - 16A version has Q3 terminals only</p>	<p><b>Actuator Style</b></p> <p><b>A</b> Momentary, Short button <b>B</b> Momentary, Long button <b>C</b> Momentary/Pulled out button (not available on D7 rating)</p>	<p><b>Terminals</b></p> <p><b>Q1</b> 4.8 x 0.5 <b>Q2</b> 4.8 x 0.8 <b>Q3</b> 6.3 x 0.8</p>	<p><b>Housing Color</b></p> <p><b>NONE</b> White <b>B</b> Black</p>
--	--	--	---

### International Rating Symbols

10E3	Cycles 10,000
10E4	Cycles 100,000
50E3	Cycles 50,000
10(4)	Current rating: First number represents resistive rating. Second number represents inductive (motor) rating
GP	General purpose rating UL1054



Snap-acting

# DS Series Interlock Pushbutton Switches

## NUMBER OF POLES

1 SPDT

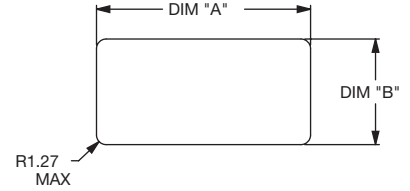
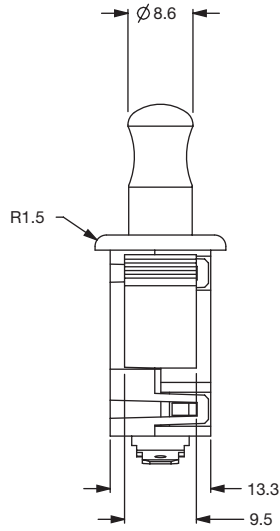

PANEL MOUNTING		
PANEL THICKNESS	DIM "A" mm	DIM "B" mm
1.14	28.32	13.97
2.54	28.58	13.97

2 DPDT

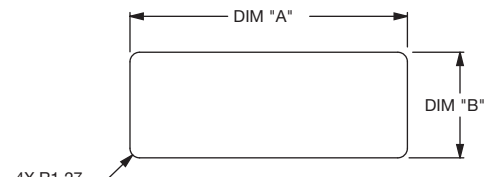
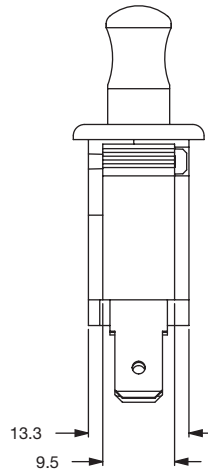
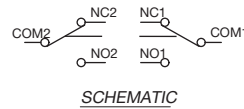
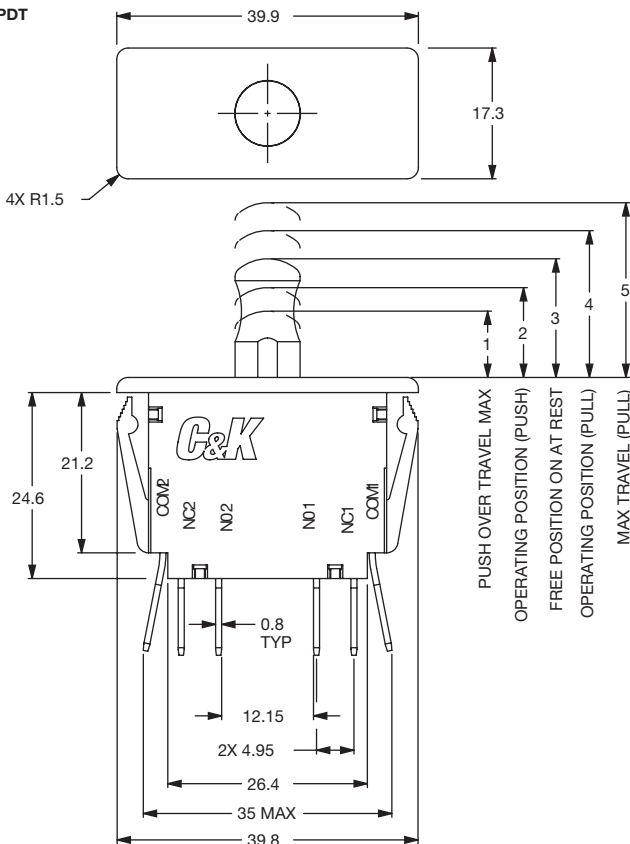

PANEL MOUNTING		
PANEL THICKNESS	DIM "A" mm	DIM "B" mm
1.14	36.70	13.97
2.54	36.96	13.97

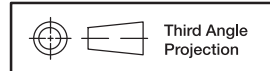

Dimensions are shown: mm  
Specifications and dimensions subject to change

Snap-acting



# DS Series Interlock Pushbutton Switches

## ACTUATOR STYLE / SPECIFICATIONS

**A** SHORT BUTTON

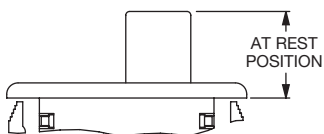

SHORT BUTTON

**B** LONG BUTTON

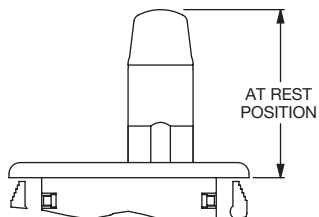

LONG BUTTON

**C** MOMENTARY/PULLED OUT

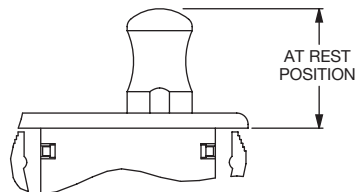

FREE POSITION

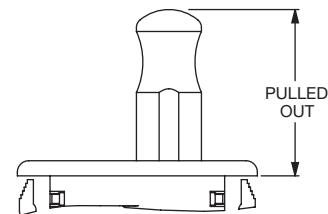

PULLED OUT POSITION

### SPDT Specification

BUTTON STYLE	OVER TRAVEL POSITION PUSH MAX	OVER TRAVEL POSITION PULL MAX	OPERATING POSITION PUSH	OPERATING POSITION PULL	FREE POSITION AT REST	OPERATING FORCE	
A	3.20	NA	8.90 ± 1.25	NA	11.45 ± 0.75	425 gf	
B	10.15	NA	19.55 ± 1.25	NA	22.25 ± 0.75	425 gf	
C	13.20	24.90	16.75 ± 1.25	21.60 ± 1.25	19.30 ± 0.75	PUSH 385gf	PULL 475gf

### DPDT Specification

BUTTON STYLE	OVER TRAVEL POSITION PUSH MAX	OVER TRAVEL POSITION PULL MAX	OPERATING POSITION PUSH	OPERATING POSITION PULL	FREE POSITION AT REST	OPERATING FORCE	
A	3.20	NA	8.90 ± 1.25	NA	11.45 ± 0.75	680 gf	
B	10.15	NA	19.55 ± 1.25	NA	22.25 ± 0.75	680gf	
C	13.20	24.90	16.75 ± 1.25	21.60 ± 1.25	19.30 ± 0.75	PUSH 560gf	PULL 750gf

## TERMINALS

**Q1** 4.8 x 0.5  
**Q2** 4.8 x 0.8

**Q3** 6.3 x 0.8

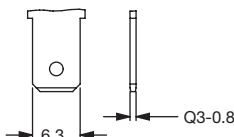
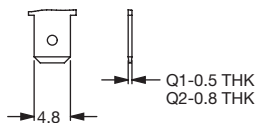

Third Angle Projection

Dimensions are shown: mm  
Specifications and dimensions subject to change



Snap-acting



Компания «ЭлектроПласт» предлагает заключение долгосрочных отношений при поставках импортных электронных компонентов на взаимовыгодных условиях!

Наши преимущества:

- Оперативные поставки широкого спектра электронных компонентов отечественного и импортного производства напрямую от производителей и с крупнейших мировых складов;
- Поставка более 17-ти миллионов наименований электронных компонентов;
- Поставка сложных, дефицитных, либо снятых с производства позиций;
- Оперативные сроки поставки под заказ (от 5 рабочих дней);
- Экспресс доставка в любую точку России;
- Техническая поддержка проекта, помощь в подборе аналогов, поставка прототипов;
- Система менеджмента качества сертифицирована по Международному стандарту ISO 9001;
- Лицензия ФСБ на осуществление работ с использованием сведений, составляющих государственную тайну;
- Поставка специализированных компонентов (Xilinx, Altera, Analog Devices, Intersil, Interpoint, Microsemi, Aeroflex, Peregrine, Syfer, Eurofarad, Texas Instrument, Miteq, Cobham, E2V, MA-COM, Hittite, Mini-Circuits, General Dynamics и др.);

Помимо этого, одним из направлений компании «ЭлектроПласт» является направление «Источники питания». Мы предлагаем Вам помощь Конструкторского отдела:

- Подбор оптимального решения, техническое обоснование при выборе компонента;
- Подбор аналогов;
- Консультации по применению компонента;
- Поставка образцов и прототипов;
- Техническая поддержка проекта;
- Защита от снятия компонента с производства.



#### Как с нами связаться

**Телефон:** 8 (812) 309 58 32 (многоканальный)

**Факс:** 8 (812) 320-02-42

**Электронная почта:** [org@eplast1.ru](mailto:org@eplast1.ru)

**Адрес:** 198099, г. Санкт-Петербург, ул. Калинина, дом 2, корпус 4, литера А.