

# DATA SHEET

**CURRENT SENSOR - LOW TCR**

AUTOMOTIVE GRADE

PE\_L series

5%, 1%, 0.5%

sizes

0201/0402/ 0603/ 0805/ 1206/ 2010/ 2512

RoHS compliant & Halogen free



**SCOPE**

This specification describes PE series current sensor - low TCR with lead-free terminations made by metal foil with ceramic substrate.

**APPLICATIONS**

- Consumer goods
- Computer
- Telecom / Datacom
- Industrial / Power supply
- Automotive
- Alternative Energy

**FEATURES**

- AEC-Q200 qualified
- Halogen-free Epoxy
- RoHS compliant
- Reduce environmentally hazardous wastes
- High component and equipment reliability
- None forbidden-materials used in products/production
- Low resistances applied to current sensing

**ORDERING INFORMATION - GLOBAL PART NUMBER**

Global part numbers are identified by the series, size, tolerance, packing type, temperature coefficient, taping reel and resistance value.

**GLOBAL PART NUMBER**

**PE   XXXX   X   X   X   XX   XXXX   L**  
 (1)   (2) (3) (4) (5)   (6)   (7)

**(1) SIZE**

0201/ 0402/ 0603/ 0805/ 1206/ 2010/ 2512

**(2) TOLERANCE**

D = ±0.5% (≥10mΩ)    F = ±1%    J = ±5%

**(3) PACKAGING TYPE**

R = Paper/ PE taping reel  
 K = Embossed taping reel

**(4) TEMPERATURE COEFFICIENT OF RESISTANCE**

E = ±50 ppm/°C  
 M = ±75 ppm/°C  
 F = ±100 ppm/°C  
 J = ±350 ppm/°C

**(5) TAPING REEL**

07 / 7W / 7T / 47 / 57= 7 inch dia. Reel and specific rated power.  
 Detailed power rating are shown in the Table 2.

**(6) RESISTANCE VALUE**

5 mΩ to 910 mΩ  
 There are 3~5 digits indicated the resistance value. Letter R is decimal point.  
 Detailed coding rules of resistance are shown in the table of "Resistance rule of global part number".

**(7) DEFAULT CODE**

Letter L is the system default code for ordering only. (Note)

Resistance rule of global part number	
Resistance code rule	Example
0RXXX	0R001 = 1 mΩ
(1 to 910 mΩ)	0R1 = 100 mΩ
	0R91 = 910 mΩ

**ORDERING EXAMPLE**

The ordering code of a PE2512 1W chip resistor, value 0.006 Ω with ±1% tolerance, supplied in 7-inch tape reel is:  
**PE2512FKM070R006L**

**NOTE**

I. All our RSMD products are RoHS compliant. "LFP" of the internal 2D reel label mentions "Lead-Free Process"

**MARKING**

PE0201 / PE0402

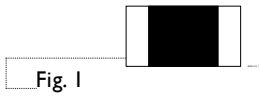

No marking

PE0603

$5\text{m}\Omega \leq R \leq 50\text{m}\Omega$

$51\text{m}\Omega \leq R \leq 910\text{m}\Omega$

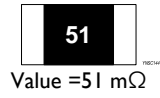
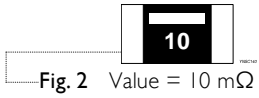

2 digits

PE0805

$5\text{m}\Omega \leq R \leq 50\text{m}\Omega$

$51\text{m}\Omega \leq R \leq 910\text{m}\Omega$

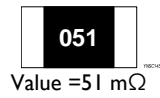
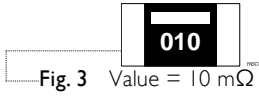

3 digits

PE1206

$5\text{m}\Omega \leq R \leq 50\text{m}\Omega$

$51\text{m}\Omega \leq R \leq 910\text{m}\Omega$

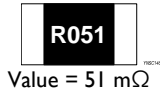
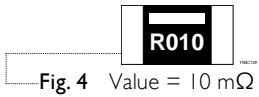

4 digits

The "R" is used as a decimal point; the other 3 digits are significant.

PE2010 / PE2512

$5\text{m}\Omega \leq R \leq 100\text{m}\Omega$

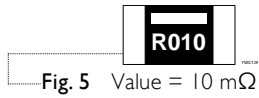

4 digits

The "R" is used as a decimal point; the other 3 digits are significant.

**Outlines**

For dimensions, please refer to Table I

$5\text{m}\Omega \leq R \leq 50\text{m}\Omega$

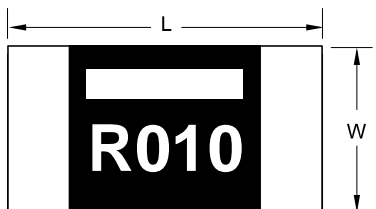

$51\text{m}\Omega \leq R \leq 910\text{m}\Omega$

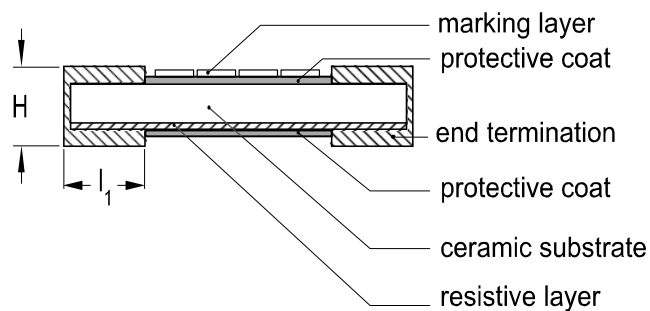

YNSC14E

Fig. 5 Chip resistor outlines

**DIMENSION**
**Table 1** For outlines, please refer to Fig. 4

TYPE	RESISTANCE RANGE	L (mm)	W (mm)	H (mm)	l <sub>1</sub> (mm)
PE0201	50 mΩ ≤ R ≤ 200 mΩ	0.60±0.03	0.31±0.04	0.27±0.04	0.14±0.06
PE0402	10 mΩ ≤ R ≤ 910 mΩ	1.00+0.10/-0.15	0.50+0.10/-0.15	0.35±0.15	0.25±0.10
PE0603	5 mΩ, 10 mΩ, 15mΩ, 20 mΩ ≤ R ≤ 50 mΩ	1.60±0.20	0.76±0.25	0.35±0.25	0.38±0.25
	51 mΩ ≤ R ≤ 910 mΩ	1.52±0.25	0.76±0.25	0.45±0.10	0.38±0.25
PE0805	5 mΩ, 10 mΩ, 15mΩ, 20 mΩ ≤ R ≤ 50 mΩ	2.03±0.25	1.27±0.25	0.35±0.25	0.38±0.25
	51 mΩ ≤ R ≤ 910 mΩ	2.03±0.25	1.27±0.25	0.55±0.10	0.35±0.20
PE1206	5 mΩ	3.20±0.25	1.60±0.25	0.64±0.25	0.64±0.25
	6 mΩ ≤ R ≤ 910 mΩ	3.20±0.25	1.60±0.25	0.64±0.25	0.51±0.25
PE2010	5 mΩ ≤ R ≤ 6 mΩ	5.08±0.25	2.54±0.25	0.64±0.25	1.47±0.25
	7 mΩ ≤ R ≤ 100 mΩ	5.08±0.25	2.54±0.25	0.64±0.25	0.51±0.25
PE2512	6 mΩ ≤ R ≤ 100 mΩ	6.35±0.25	3.18±0.25	0.64±0.25	0.76±0.25

**Note:**

1. For relevant physical dimensions, please refer to construction outlines.
2. Please contact with sales offices, distributors and representatives in your region before ordering.

**ELECTRICAL CHARACTERISTICS**

Table 2

SERIES	SIZE	POWER RATING (1)					TOLERANCE	RESISTANCE RANGE	TEMPERATURE COEFFICIENT OF RESISTANCE
		07	7W	7T	47	57			
PE	0201	1/20W	1/10W	---	---	---	±0.5% (≥10 mΩ)	50 mΩ ≤ R ≤ 200mΩ	20mΩ ≤ R ≤ 70mΩ ±350ppm/°C 70mΩ < R ≤ 200mΩ ±100ppm/°C
	0402	1/16W	1/8W	1/6W	1/4W	---	±1%	10 mΩ ≤ R ≤ 910 mΩ	±100 ppm/°C
	0603	1/10W	1/5W	1/3W	2/5W	1/2W	±5%	5mΩ, 10mΩ, 15mΩ	±75 ppm/°C
	0805	1/8W	1/4W	1/3W	1/2W	---	±1%	20 mΩ ≤ R ≤ 910 mΩ	±100 ppm/°C
	1206	1/4W	1/2W	---	1W	---	±5%	5 mΩ ≤ R ≤ 910 mΩ	±100 ppm/°C
	2010	1/2W	1W	---	---	---		5mΩ ≤ R ≤ 100mΩ	±50 ppm/°C
	2512	1W	2W	---	---	---		6mΩ ≤ R ≤ 100mΩ	±75 ppm/°C ±100 ppm/°C

- Note: 1. Global part number (code 10 - 11)  
2. Please contact with sales offices, distributors and representatives in your region before ordering.

**FUNCTIONAL DESCRIPTION**

**OPERATING TEMPERATURE RANGE**

PE0201 to PE0402 Range: -55°C to +125°C (Fig. 6-1)

PE0603 to PE2512 Range: -55°C to +170°C (Fig. 6-2)

**POWER RATING**

Standard rated power at 70°C:

- PE0201 = 1/20W
- PE0402 = 1/16W
- PE0603 = 1/10W
- PE0805 = 1/8W
- PE1206 = 1/4W
- PE2010 = 1/2W
- PE2512 = 1W

For detail power value, please refer to Table 2.

**RATED VOLTAGE**

The DC or AC (rms) continuous working voltage corresponding to the rated power is determined by the following formula:

$$V = \sqrt{P \times R}$$

Where

V = Continuous rated DC or AC (rms) working voltage (V)

P = Rated power (W)

R = Resistance value (Ω)

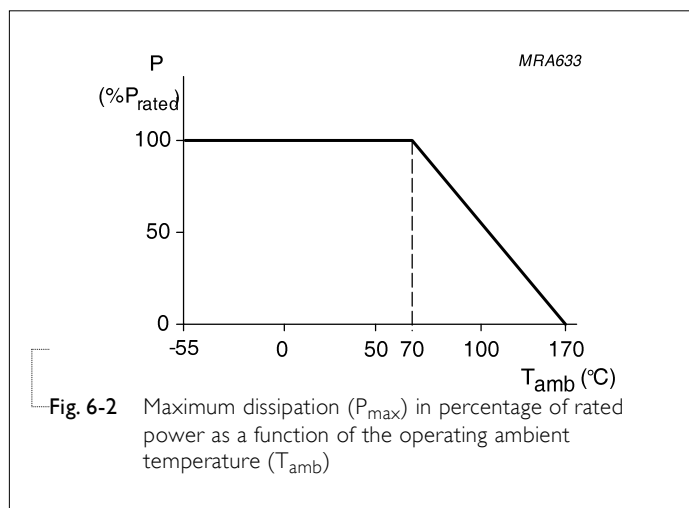
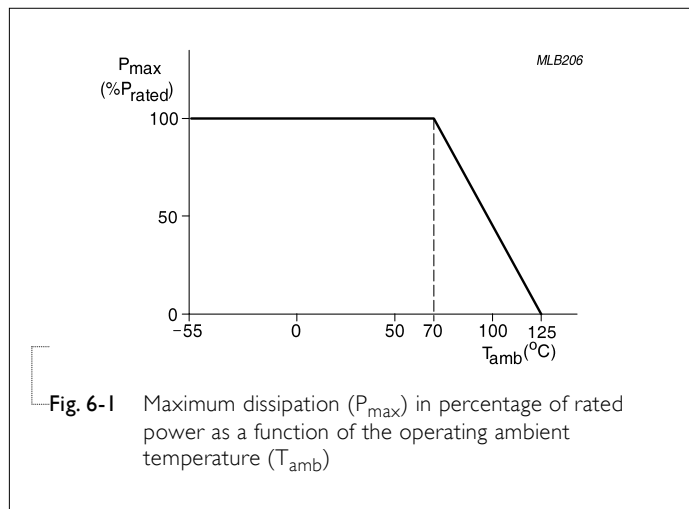

**PACKING STYLE AND PACKAGING QUANTITY**

Table 3 Packing style and packaging quantity

PACKING STYLE	REEL DIMENSION	PE0201	PE0402	PE0603	PE0805	PE1206	PE2010	PE2512
Paper taping reel (R)	7" (178 mm)	10,000	10,000	5,000	5,000	4,000	---	---
Embossed taping reel (K)	7" (178 mm)	---	---	---	---	---	4,000	4,000

**PAPER TAPE**

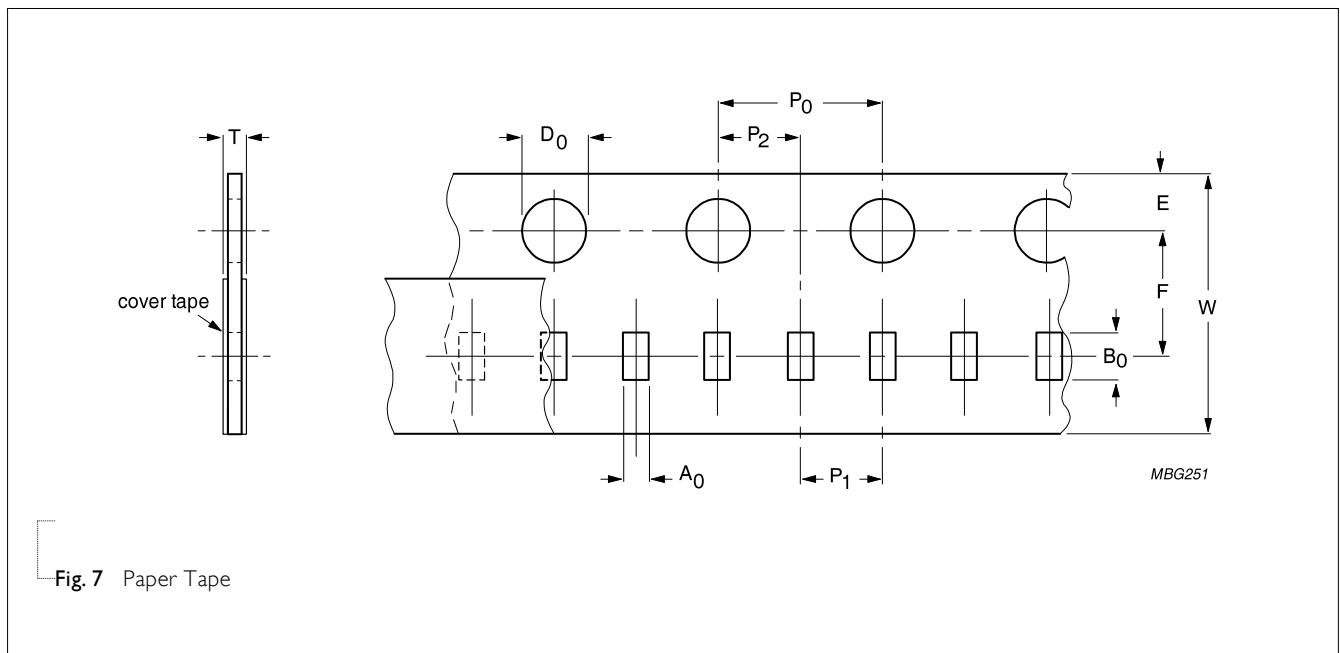

Fig. 7 Paper Tape

Table 4 Dimensions of paper tape for relevant chip resistors size

SIZE	SYMBOL										Unit: mm
	A <sub>0</sub>	B <sub>0</sub>	W	E	F	P <sub>0</sub>	P <sub>1</sub>	P <sub>2</sub>	ØD <sub>0</sub>	T	
PE0201	0.35±0.10	1.65±0.10	8.00±0.30	1.75±0.10	3.50±0.10	4.00±0.10	2.00±0.05	2.00±0.05	1.50±0.10	0.53±0.10	
PE0402	0.65±0.10	1.15±0.10	8.00±0.30	1.75±0.10	3.50±0.10	4.00±0.10	2.00±0.05	2.00±0.05	1.50±0.10	0.53±0.10	
PE0603	1.20±0.15	1.90±0.15	8.00±0.30	1.75±0.10	3.50±0.10	4.00±0.10	4.00±0.10	2.00±0.10	1.50±0.10	0.55±0.15	
PE0805	1.60±0.15	2.30±0.15	8.00±0.30	1.75±0.10	3.50±0.10	4.00±0.10	4.00±0.10	2.00±0.10	1.50±0.10	0.85±0.15	
PE1206	1.90±0.10	3.50±0.10	8.00±0.30	1.75±0.10	3.50±0.10	4.00±0.10	4.00±0.10	2.00±0.10	1.50±0.10	1.50±0.10	

**EMBOSSED TAPE**

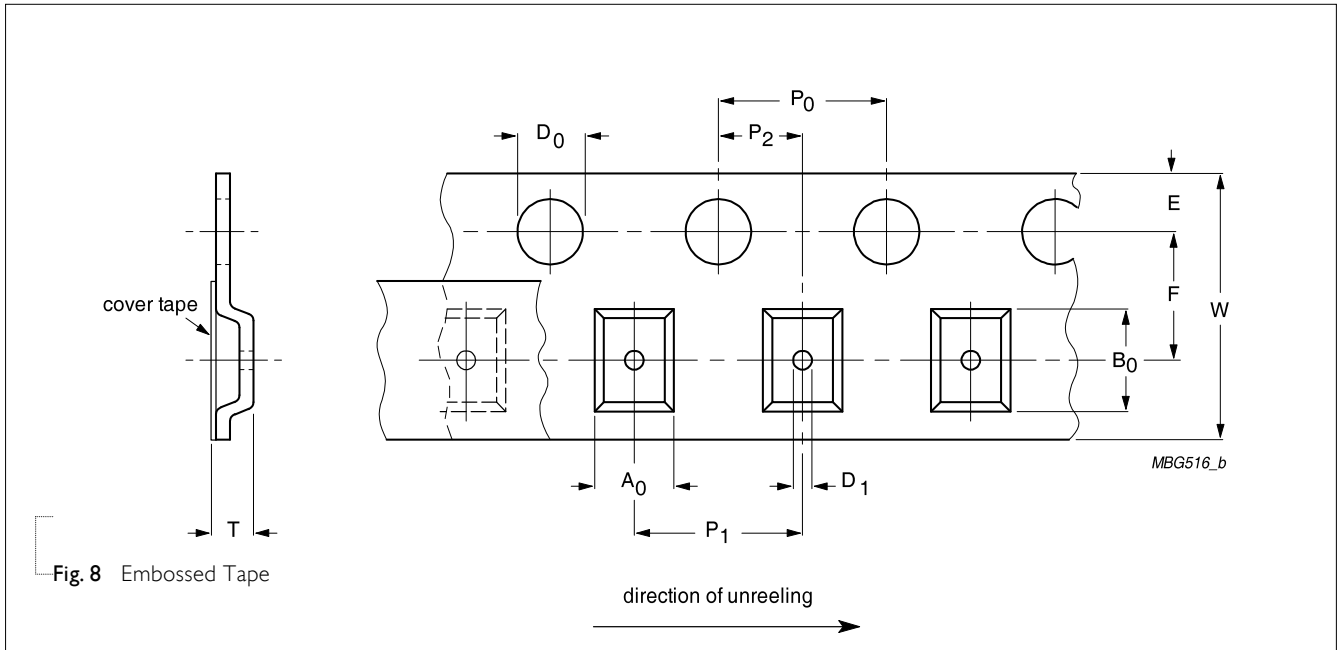

Fig. 8 Embossed Tape

Table 5 Dimensions of embossed tape for relevant chip resistors size

SIZE	SYMBOL											Unit: mm
	A <sub>0</sub>	B <sub>0</sub>	W	E	F	P <sub>0</sub>	P <sub>1</sub>	P <sub>2</sub>	ØD <sub>0</sub>	ØD <sub>1</sub>	T	
PE2010	3.00±0.15	5.60±0.15	12.10±0.30	1.75±0.10	5.50±0.10	4.00±0.10	4.00±0.10	2.00±0.10	1.50±0.10	1.50±0.10	0.80±0.15	
PE2512	3.40±0.15	6.70±0.15	12.10±0.30	1.75±0.10	5.50±0.10	4.00±0.10	4.00±0.10	2.00±0.10	1.50±0.10	1.50±0.10	0.80±0.15	

**REEL SPECIFICATION**

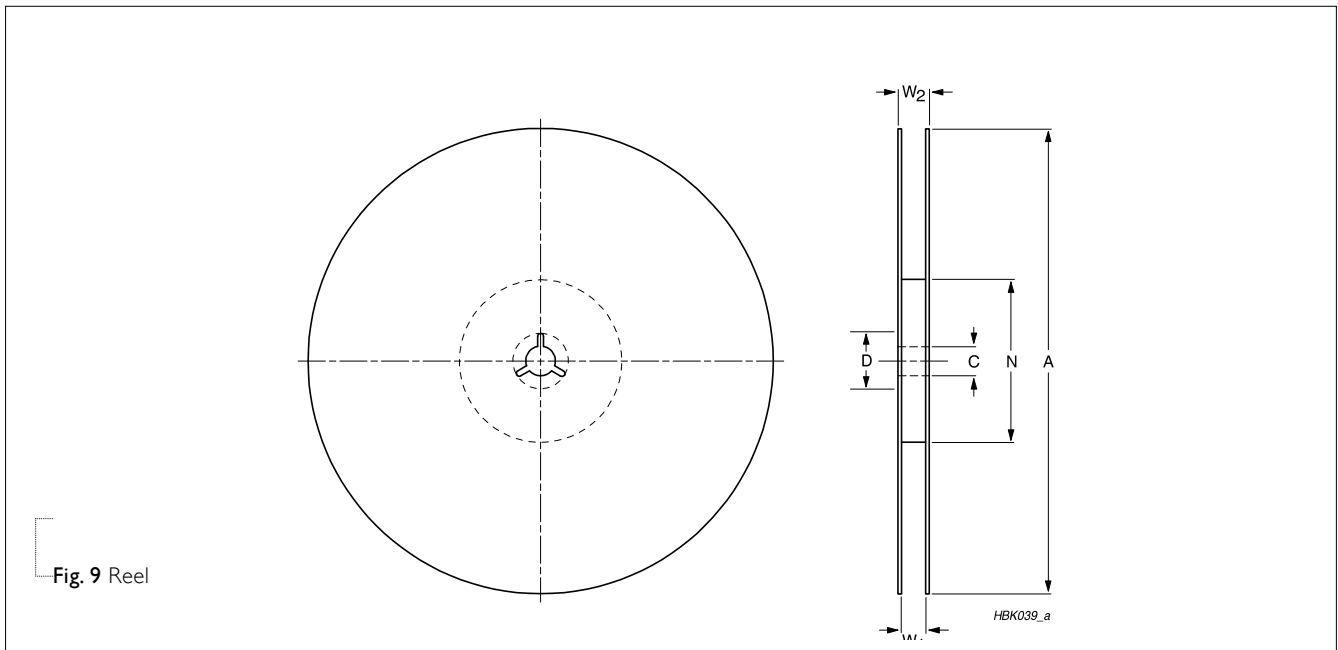

Fig. 9 Reel

Table 6 Dimensions of reel specification for relevant chip resistors size

SIZE	QUANTITY PER REEL	REEL SIZE			SYMBOL		Unit: mm				
		8 mm TAPE WIDE	12 mm TAPE WIDE	24 mm TAPE WIDE	A	N	C	D	$W_1$	$W_2$ MAX.	
PE0201	10,000	7" ( $\varnothing 178$ mm)	---	---	180.0+0/-3	60.0+1/-0	13.0±0.2	21.0±0.8	9.0±0.30	12.4	
PE0402	10,000	7" ( $\varnothing 178$ mm)	---	---	180.0+0/-3	60.0+1/-0	13.0±0.2	21.0±0.8	9.0±0.30	12.4	
PE0603	5000	7" ( $\varnothing 178$ mm)	--	--	180.0+0/-3	60.0+1/-0	13.0±0.2	21.0±0.8	8.4 +1/-0	12.4	
PE0805	5000	7" ( $\varnothing 178$ mm)	--	--	180.0+0/-3	60.0+1/-0	13.0±0.2	21.0±0.8	8.4 +1/-0	12.4	
PE1206	4000	7" ( $\varnothing 178$ mm)	--	--	180.0+0/-3	60.0+1/-0	13.0±0.2	21.0±0.8	8.4 +1/-0	12.4	
PE2010	4000	--	7" ( $\varnothing 178$ mm)	--	180.0+0/-3	60.0+1/-0	13.0±0.2	21.0±0.8	12.3 +1/-0	18.4	
PE2512	4000	--	7" ( $\varnothing 178$ mm)	--	180.0+0/-3	60.0+1/-0	13.0±0.2	21.0±0.8	12.3 +1/-0	18.4	

**LEADER/TRAILER TAPE SPECIFICATION**

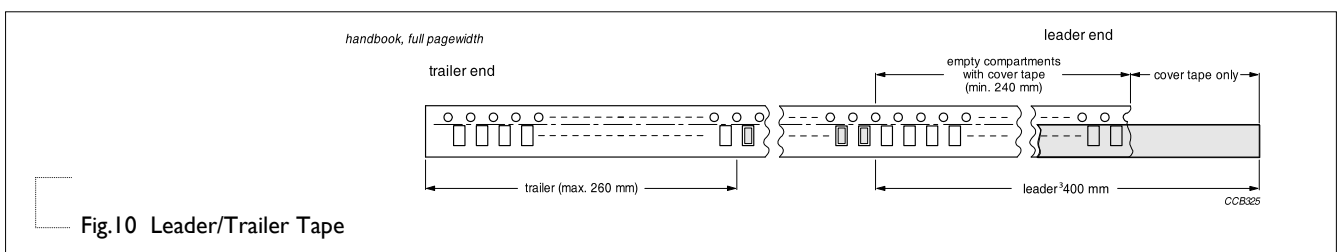

Fig.10 Leader/Trailer Tape



**FOOTPRINT AND SOLDERING PROFILES**

For recommended soldering profiles, please refer to data sheet “Chip resistors mounting”.

**FOOTPRINT**

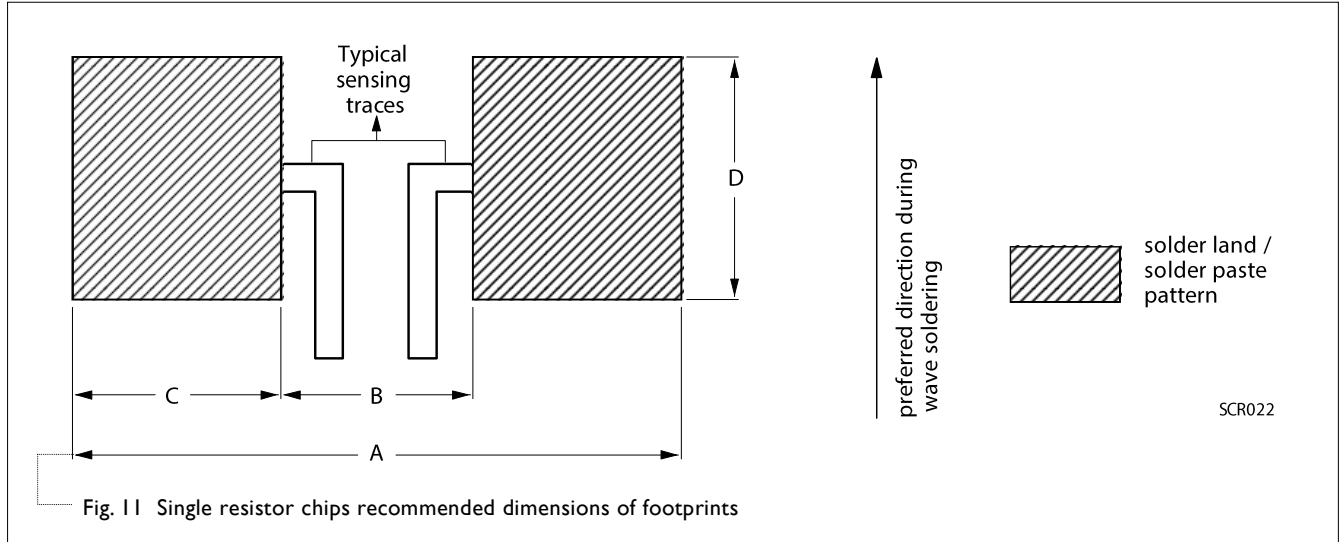

Table 7 Footprint dimensions

SIZE	RESISTANCE RANGE	Unit: mm			
		A	B	C	D
PE0201	50 mΩ ≤ R ≤ 200 mΩ	1.00	0.30	0.35	0.40
PE0402	10 mΩ ≤ R ≤ 910 mΩ	1.45	0.35	0.55	0.55
PE0603	5 mΩ, 10 mΩ, 15 mΩ, 20mΩ ≤ R ≤ 910 mΩ	2.52	0.50	1.01	1.01
PE0805	5 mΩ, 10 mΩ, 15 mΩ, 20mΩ ≤ R ≤ 910 mΩ	2.54	0.50	1.02	1.27
PE1206	5 mΩ ≤ R ≤ 910 mΩ	3.90	0.76	1.57	1.78
PE2010	5 mΩ ≤ R ≤ 6 mΩ	6.12	1.40	2.36	3.05
	7 mΩ ≤ R ≤ 100 mΩ	6.10	3.30	1.40	3.05
PE2512	6 mΩ	7.40	3.18	2.11	3.68
	7 mΩ ≤ R ≤ 100 mΩ	7.36	4.06	1.65	3.68

**TESTS AND REQUIREMENTS**
**Table 8 Test condition, procedure and requirements**

TEST	TEST METHOD	PROCEDURE	REQUIREMENTS
Life/ Operational Life/ Endurance	MIL-STD-202G-method 108 IEC 60115-1 4.25.1	1,000 hours at 70±2 °C applied RCWV 1.5 hours on, 0.5 hour off, still air required	±(1%+0.0005 Ω)
High Temperature Exposure/ Endurance at Upper Category Temperature	MIL-STD-202G-method 108 IEC 60115-1 4.25.3	1,000 hours at maximum operating temperature depending on specification, unpowered No direct impingement of forced air to the parts Tolerances: 0201/0402 155±3°C 0603 and above 170±3°C	±(1%+0.0005 Ω)
Moisture Resistance	MIL-STD-202G-method 106	Each temperature / humidity cycle is defined at 8 hours (method 106F), 3 cycles / 24 hours for 10d with 25 °C / 65 °C 95% R.H, without steps 7a & 7b, unpowered Parts mounted on test-boards, without condensation on parts Measurement at 24±2 hours after test conclusion	±(0.5%+0.0005 Ω)
Thermal Shock	MIL-STD-202G-method 107	-55/+125 °C Note: Number of cycles required is 300. Devices mounted Maximum transfer time is 20 seconds. Dwell time is 15 minutes. Air – Air	±(1%+0.0005 Ω)
Short Time Overload	IEC60115-1 4.13	5 times of rated power for 5 seconds at room temperature	±(1%+0.0005 Ω) No visible damage
Board Flex/ Bending	IEC60115-1 4.33	Device mounted on PCB test board as described, only 1 board bending required Bending for 0201: 3mm 0402 and above: 2mm Holding time: minimum 60 seconds	±(1%+0.0005 Ω) No visible damage
Biased Humidity	MIL-STD-202 Method 103	1,000 hours at 85°C/85%R.H. 10% of operating power, no condensation on the devices, circulating air.	± (1.0 % + 0.0005Ω)

TEST	TEST METHOD	PROCEDURE	REQUIREMENTS
Solderability - Wetting	IPC/JEDEC	Electrical Test not required	Well tinned (≥95% covered)
	J-STD-002B test B	Magnification 50X SMD conditions: 1 <sup>st</sup> step: method B, aging 4 hours at 155 °C dry heat 2 <sup>nd</sup> step: leadfree solder bath at 245±3 °C Dipping time: 3±0.5 seconds	No visible damage
- Leaching	IPC/JEDEC J-STD-002B test D	Leadfree solder, 260 °C, 30 seconds immersion time	No visible damage
- Resistance to Soldering Heat	MIL-STD-202G-method 210F	Condition B, no pre-heat of samples	±(0.5%+0.0005 Ω)
	IEC 60115-1 4.18	Leadfree solder, 260 °C, 10 seconds immersion time Procedure 2 for SMD: devices fluxed and cleaned with isopropanol	No visible damage

**REVISION HISTORY**

REVISION	DATE	CHANGE NOTIFICATION	DESCRIPTION
Version 5	Nov 23,2016	-	- Extend resistor value for 0.5%
Version 4	Dec. 21, 2015	-	- Update resistance value
Version 3	Aug. 06, 2015	-	- Update 0603 to 1206 TCR
Version 2	Apr. 20, 2015	-	- Extend resistor value
Version 1	Mar. 04, 2015	-	- Update TCR and operating temperature
Version 0	Feb. 10, 2015	-	- New datasheet for current sensor - low TCR PE series sizes of 0201/0402/0603/0805/1206/2010/2512, 0.5%, 1%, and 5%

*“Yageo reserves all the rights for revising the content of this datasheet without further notification, as long as the products itself are unchanged. Any product change will be announced by PCN.”*

# Mouser Electronics

Authorized Distributor

Click to View Pricing, Inventory, Delivery & Lifecycle Information:

## Yageo:

[PE2512FKE7W0R025L](#) [PE2512FKE7W0R02L](#) [PE2512FKE7W0R033L](#) [PE2512FKE7W0R03L](#)  
[PE2512FKE7W0R04L](#) [PE2512FKE7W0R06L](#) [PE0805FRF470R01L](#) [PE2512FKE070R006L](#) [PE2512FKE070R007L](#)  
[PE2512FKE070R008L](#) [PE2512FKE070R009L](#) [PE2512FKE070R015L](#) [PE2512FKE070R01L](#) [PE2512FKE070R02L](#)  
[PE2512FKE070R033L](#) [PE2512FKE070R03L](#) [PE2512FKE070R04L](#) [PE2512FKE070R05L](#) [PE2512FKE070R07L](#)  
[PE2512FKE070R08L](#) [PE2512FKE070R1L](#) [PE2512FKE7W0R006L](#) [PE2512FKE7W0R007L](#) [PE2512FKE7W0R008L](#)  
[PE2512FKE7W0R009L](#) [PE2512FKE7W0R012L](#) [PE2512FKE7W0R015L](#) [PE2512FKE7W0R018L](#)  
[PE2512FKE7W0R01L](#) [PE2512FKE7W0R022L](#) [PE0805FRF470R05L](#) [PE0805FRM7W0R033L](#) [PE0603FRF070R015L](#)  
[PE0603FRF070R025L](#) [PE0603FRF070R02L](#) [PE0603FRF070R04L](#) [PE0603FRF070R05L](#) [PE0603FRF070R1L](#)  
[PE0603FRF470R1L](#) [PE0603FRF7W0R04L](#) [PE0603FRF7W0R1L](#) [PE0603FRM570R01L](#) [PE0805FRF070R015L](#)  
[PE0805FRF070R01L](#) [PE0805FRF070R025L](#) [PE0805FRF070R02L](#) [PE0805FRF070R033L](#) [PE0805FRF070R03L](#)  
[PE0805FRF070R047L](#) [PE0805FRF070R04L](#) [PE0805FRF070R05L](#) [PE0805FRF070R15L](#) [PE0805FRF070R1L](#)  
[PE0805FRF470R017L](#) [PE0805FRF470R025L](#) [PE0805FRF7W0R005L](#) [PE0805FRF7W0R01L](#) [PE0805FRF7W0R02L](#)  
[PE0805FRF7W0R033L](#) [PE0805FRF7W0R03L](#) [PE0805FRF7W0R04L](#) [PE0805FRF7W0R15L](#) [PE0805FRF7W0R1L](#)  
[PE0805FRF7W0R2L](#) [PE0805FRM470R02L](#) [PE1206FRF070R005L](#) [PE1206FRF070R006L](#) [PE1206FRF070R008L](#)  
[PE1206FRF070R012L](#) [PE1206FRF070R015L](#) [PE1206FRF070R01L](#) [PE1206FRF070R022L](#) [PE1206FRF070R025L](#)  
[PE1206FRF070R02L](#) [PE1206FRF070R033L](#) [PE1206FRF070R039L](#) [PE1206FRF070R03L](#) [PE1206FRF070R047L](#)  
[PE1206FRF070R04L](#) [PE1206FRF070R056L](#) [PE1206FRF070R05L](#) [PE1206FRF070R068L](#) [PE1206FRF070R06L](#)  
[PE1206FRF070R075L](#) [PE1206FRF070R15L](#) [PE1206FRF070R18L](#) [PE1206FRF470R005L](#) [PE1206FRF470R01L](#)  
[PE1206FRF470R022L](#) [PE1206FRF470R02L](#) [PE1206FRF470R033L](#) [PE1206FRF470R03L](#) [PE1206FRF470R05L](#)  
[PE1206FRF7W0R015L](#) [PE1206FRF7W0R01L](#) [PE1206FRF7W0R025L](#) [PE1206FRF7W0R02L](#)  
[PE1206FRF7W0R033L](#) [PE1206FRF7W0R03L](#) [PE1206FRF7W0R04L](#)



Компания «ЭлектроПласт» предлагает заключение долгосрочных отношений при поставках импортных электронных компонентов на взаимовыгодных условиях!

Наши преимущества:

- Оперативные поставки широкого спектра электронных компонентов отечественного и импортного производства напрямую от производителей и с крупнейших мировых складов;
- Поставка более 17-ти миллионов наименований электронных компонентов;
- Поставка сложных, дефицитных, либо снятых с производства позиций;
- Оперативные сроки поставки под заказ (от 5 рабочих дней);
- Экспресс доставка в любую точку России;
- Техническая поддержка проекта, помощь в подборе аналогов, поставка прототипов;
- Система менеджмента качества сертифицирована по Международному стандарту ISO 9001;
- Лицензия ФСБ на осуществление работ с использованием сведений, составляющих государственную тайну;
- Поставка специализированных компонентов (Xilinx, Altera, Analog Devices, Intersil, Interpoint, Microsemi, Aeroflex, Peregrine, Syfer, Eurofarad, Texas Instrument, Miteq, Cobham, E2V, MA-COM, Hittite, Mini-Circuits, General Dynamics и др.);

Помимо этого, одним из направлений компании «ЭлектроПласт» является направление «Источники питания». Мы предлагаем Вам помощь Конструкторского отдела:

- Подбор оптимального решения, техническое обоснование при выборе компонента;
- Подбор аналогов;
- Консультации по применению компонента;
- Поставка образцов и прототипов;
- Техническая поддержка проекта;
- Защита от снятия компонента с производства.



#### Как с нами связаться

**Телефон:** 8 (812) 309 58 32 (многоканальный)

**Факс:** 8 (812) 320-02-42

**Электронная почта:** [org@eplast1.ru](mailto:org@eplast1.ru)

**Адрес:** 198099, г. Санкт-Петербург, ул. Калинина, дом 2, корпус 4, литера А.