

DATA SHEET

CURRENT SENSOR - LOW TCR

AUTOMOTIVE GRADE

PE_L series

5%, 1%, 0.5%

sizes

0201/0402/ 0603/ 0805/ 1206/ 2010/ 2512

RoHS compliant & Halogen free



SCOPE

This specification describes PE series current sensor - low TCR with lead-free terminations made by metal foil with ceramic substrate.

APPLICATIONS

- Consumer goods
- Computer
- Telecom / Datacom
- Industrial / Power supply
- Automotive
- Alternative Energy

FEATURES

- AEC-Q200 qualified
- Halogen-free Epoxy
- RoHS compliant
- Reduce environmentally hazardous wastes
- High component and equipment reliability
- None forbidden-materials used in products/production
- Low resistances applied to current sensing

ORDERING INFORMATION - GLOBAL PART NUMBER

Global part numbers are identified by the series, size, tolerance, packing type, temperature coefficient, taping reel and resistance value.

GLOBAL PART NUMBER

PE XXXX X X X XX XXXX L
 (1) (2) (3) (4) (5) (6) (7)

(1) SIZE

0201/ 0402/ 0603/ 0805/ 1206/ 2010/ 2512

(2) TOLERANCE

D = ±0.5% (≥10mΩ) F = ±1% J = ±5%

(3) PACKAGING TYPE

R = Paper/ PE taping reel
 K = Embossed taping reel

(4) TEMPERATURE COEFFICIENT OF RESISTANCE

E = ±50 ppm/°C
 M = ±75 ppm/°C
 F = ±100 ppm/°C
 J = ±350 ppm/°C

(5) TAPING REEL

07 / 7W / 7T / 47 / 57= 7 inch dia. Reel and specific rated power.
 Detailed power rating are shown in the Table 2.

(6) RESISTANCE VALUE

5 mΩ to 910 mΩ
 There are 3~5 digits indicated the resistance value. Letter R is decimal point.
 Detailed coding rules of resistance are shown in the table of "Resistance rule of global part number".

(7) DEFAULT CODE

Letter L is the system default code for ordering only. (Note)

| Resistance rule of global part number | |
|---------------------------------------|---------------|
| Resistance code rule | Example |
| 0RXXX | 0R001 = 1 mΩ |
| (1 to 910 mΩ) | 0R1 = 100 mΩ |
| | 0R91 = 910 mΩ |

ORDERING EXAMPLE

The ordering code of a PE2512 1W chip resistor, value 0.006 Ω with ±1% tolerance, supplied in 7-inch tape reel is:
PE2512FKM070R006L

NOTE

I. All our RSMD products are RoHS compliant. "LFP" of the internal 2D reel label mentions "Lead-Free Process"

MARKING

PE0201 / PE0402

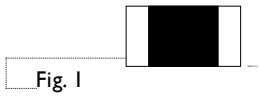

No marking

PE0603

$5\text{m}\Omega \leq R \leq 50\text{m}\Omega$

$51\text{m}\Omega \leq R \leq 910\text{m}\Omega$

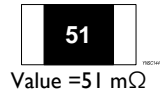
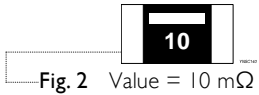

2 digits

PE0805

$5\text{m}\Omega \leq R \leq 50\text{m}\Omega$

$51\text{m}\Omega \leq R \leq 910\text{m}\Omega$

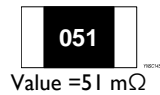
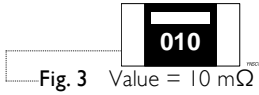

3 digits

PE1206

$5\text{m}\Omega \leq R \leq 50\text{m}\Omega$

$51\text{m}\Omega \leq R \leq 910\text{m}\Omega$

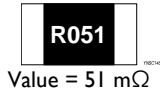
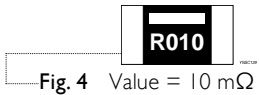

4 digits

The "R" is used as a decimal point; the other 3 digits are significant.

PE2010 / PE2512

$5\text{m}\Omega \leq R \leq 100\text{m}\Omega$

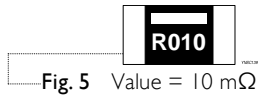

4 digits

The "R" is used as a decimal point; the other 3 digits are significant.

Outlines

For dimensions, please refer to Table I

$5\text{m}\Omega \leq R \leq 50\text{m}\Omega$

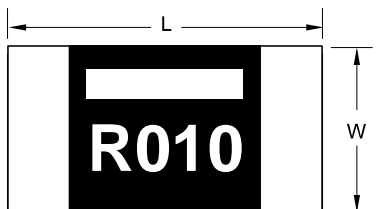

$51\text{m}\Omega \leq R \leq 910\text{m}\Omega$

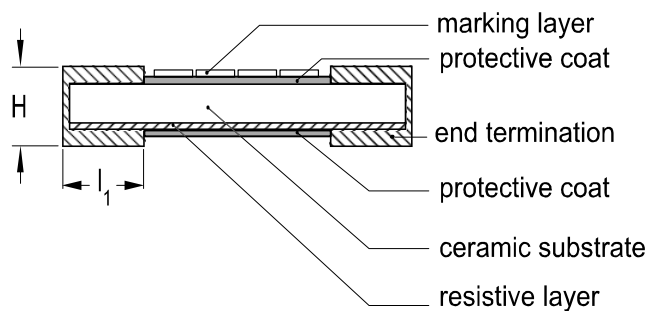

YNSC14E

Fig. 5 Chip resistor outlines

DIMENSION
Table 1 For outlines, please refer to Fig. 4

| TYPE | RESISTANCE RANGE | L (mm) | W (mm) | H (mm) | l ₁ (mm) |
|--------|--------------------------------------|-----------------|-----------------|-----------|---------------------|
| PE0201 | 50 mΩ ≤ R ≤ 200 mΩ | 0.60±0.03 | 0.31±0.04 | 0.27±0.04 | 0.14±0.06 |
| PE0402 | 10 mΩ ≤ R ≤ 910 mΩ | 1.00+0.10/-0.15 | 0.50+0.10/-0.15 | 0.35±0.15 | 0.25±0.10 |
| PE0603 | 5 mΩ, 10 mΩ, 15mΩ, 20 mΩ ≤ R ≤ 50 mΩ | 1.60±0.20 | 0.76±0.25 | 0.35±0.25 | 0.38±0.25 |
| | 51 mΩ ≤ R ≤ 910 mΩ | 1.52±0.25 | 0.76±0.25 | 0.45±0.10 | 0.38±0.25 |
| PE0805 | 5 mΩ, 10 mΩ, 15mΩ, 20 mΩ ≤ R ≤ 50 mΩ | 2.03±0.25 | 1.27±0.25 | 0.35±0.25 | 0.38±0.25 |
| | 51 mΩ ≤ R ≤ 910 mΩ | 2.03±0.25 | 1.27±0.25 | 0.55±0.10 | 0.35±0.20 |
| PE1206 | 5 mΩ | 3.20±0.25 | 1.60±0.25 | 0.64±0.25 | 0.64±0.25 |
| | 6 mΩ ≤ R ≤ 910 mΩ | 3.20±0.25 | 1.60±0.25 | 0.64±0.25 | 0.51±0.25 |
| PE2010 | 5 mΩ ≤ R ≤ 6 mΩ | 5.08±0.25 | 2.54±0.25 | 0.64±0.25 | 1.47±0.25 |
| | 7 mΩ ≤ R ≤ 100 mΩ | 5.08±0.25 | 2.54±0.25 | 0.64±0.25 | 0.51±0.25 |
| PE2512 | 6 mΩ ≤ R ≤ 100 mΩ | 6.35±0.25 | 3.18±0.25 | 0.64±0.25 | 0.76±0.25 |

Note:

1. For relevant physical dimensions, please refer to construction outlines.
2. Please contact with sales offices, distributors and representatives in your region before ordering.

ELECTRICAL CHARACTERISTICS

Table 2

| SERIES | SIZE | POWER RATING (1) | | | | | TOLERANCE | RESISTANCE RANGE | TEMPERATURE COEFFICIENT OF RESISTANCE |
|--------|------|------------------|-------|------|------|------|----------------|--------------------|---|
| | | 07 | 7W | 7T | 47 | 57 | | | |
| PE | 0201 | 1/20W | 1/10W | --- | --- | --- | ±0.5% (≥10 mΩ) | 50 mΩ ≤ R ≤ 200mΩ | 20mΩ ≤ R ≤ 70mΩ ±350ppm/°C 70mΩ < R ≤ 200mΩ ±100ppm/°C |
| | 0402 | 1/16W | 1/8W | 1/6W | 1/4W | --- | ±1% | 10 mΩ ≤ R ≤ 910 mΩ | ±100 ppm/°C |
| | 0603 | 1/10W | 1/5W | 1/3W | 2/5W | 1/2W | ±5% | 5mΩ, 10mΩ, 15mΩ | ±75 ppm/°C |
| | 0805 | 1/8W | 1/4W | 1/3W | 1/2W | --- | ±1% | 20 mΩ ≤ R ≤ 910 mΩ | ±100 ppm/°C |
| | 1206 | 1/4W | 1/2W | --- | 1W | --- | ±5% | 5 mΩ ≤ R ≤ 910 mΩ | ±100 ppm/°C |
| | 2010 | 1/2W | 1W | --- | --- | --- | ±5% | 5mΩ ≤ R ≤ 100mΩ | ±50 ppm/°C |
| | 2512 | 1W | 2W | --- | --- | --- | ±5% | 6mΩ ≤ R ≤ 100mΩ | ±75 ppm/°C ±100 ppm/°C |

- Note: 1. Global part number (code 10 - 11)
2. Please contact with sales offices, distributors and representatives in your region before ordering.

FUNCTIONAL DESCRIPTION

OPERATING TEMPERATURE RANGE

PE0201 to PE0402 Range: -55°C to +125°C (Fig. 6-1)

PE0603 to PE2512 Range: -55°C to +170°C (Fig. 6-2)

POWER RATING

Standard rated power at 70°C:

- PE0201 = 1/20W
- PE0402 = 1/16W
- PE0603 = 1/10W
- PE0805 = 1/8W
- PE1206 = 1/4W
- PE2010 = 1/2W
- PE2512 = 1W

For detail power value, please refer to Table 2.

RATED VOLTAGE

The DC or AC (rms) continuous working voltage corresponding to the rated power is determined by the following formula:

$$V = \sqrt{P \times R}$$

Where

V = Continuous rated DC or AC (rms) working voltage (V)

P = Rated power (W)

R = Resistance value (Ω)

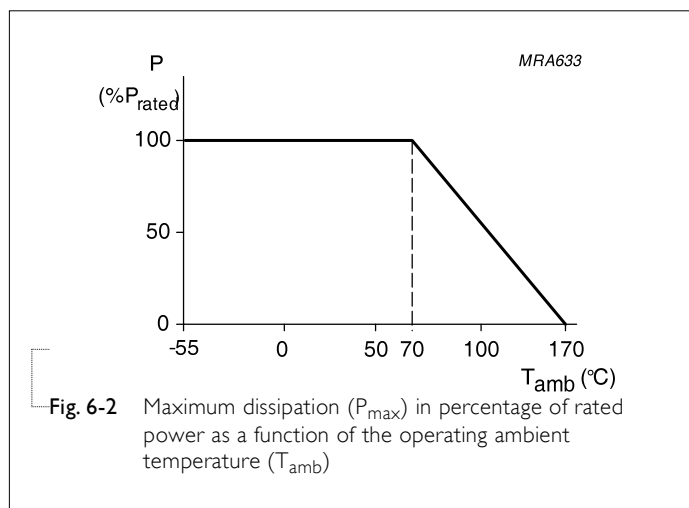
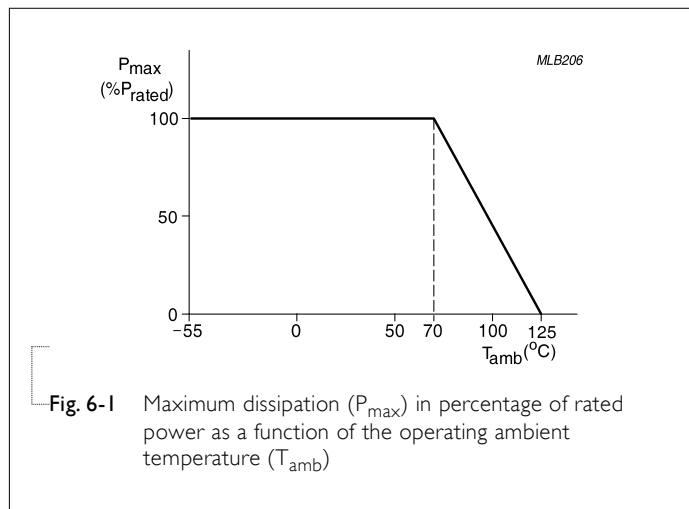

PACKING STYLE AND PACKAGING QUANTITY

Table 3 Packing style and packaging quantity

| PACKING STYLE | REEL DIMENSION | PE0201 | PE0402 | PE0603 | PE0805 | PE1206 | PE2010 | PE2512 |
|--------------------------|----------------|--------|--------|--------|--------|--------|--------|--------|
| Paper taping reel (R) | 7" (178 mm) | 10,000 | 10,000 | 5,000 | 5,000 | 4,000 | --- | --- |
| Embossed taping reel (K) | 7" (178 mm) | --- | --- | --- | --- | --- | 4,000 | 4,000 |

PAPER TAPE

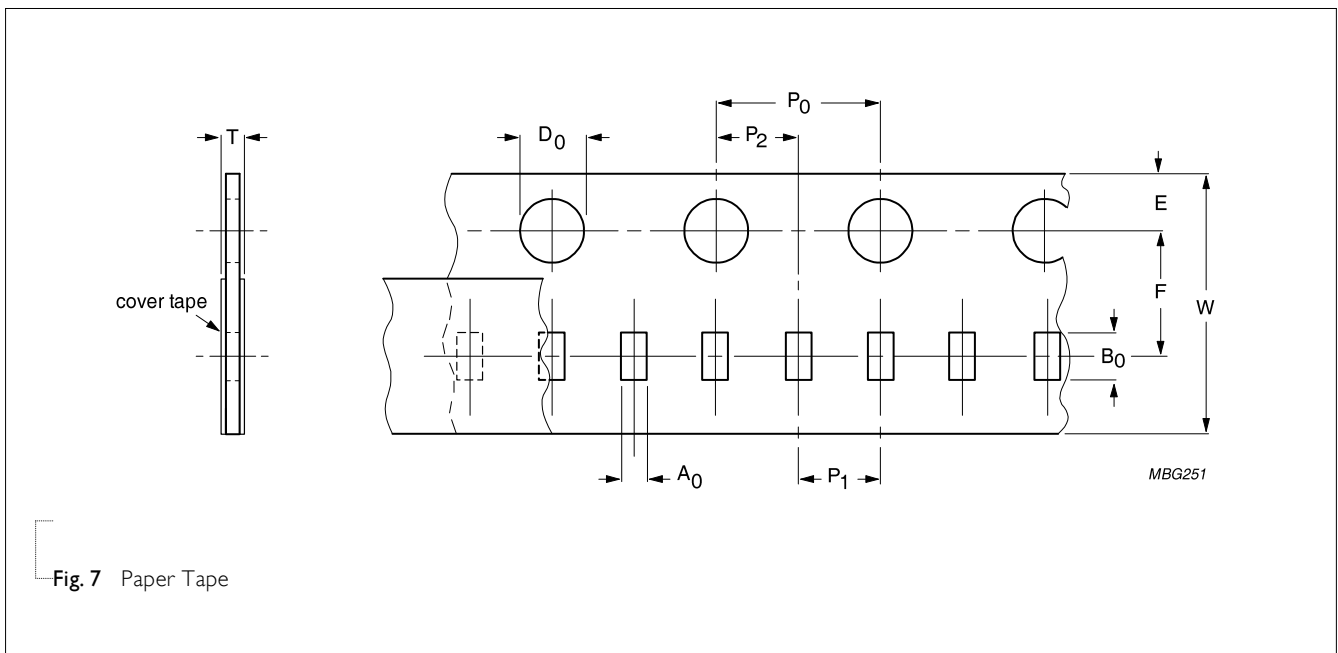

Fig. 7 Paper Tape

Table 4 Dimensions of paper tape for relevant chip resistors size

| SIZE | SYMBOL | | | | | | | | | | Unit: mm |
|--------|----------------|----------------|-----------|-----------|-----------|----------------|----------------|----------------|-----------------|-----------|----------|
| | A ₀ | B ₀ | W | E | F | P ₀ | P ₁ | P ₂ | ØD ₀ | T | |
| PE0201 | 0.35±0.10 | 1.65±0.10 | 8.00±0.30 | 1.75±0.10 | 3.50±0.10 | 4.00±0.10 | 2.00±0.05 | 2.00±0.05 | 1.50±0.10 | 0.53±0.10 | |
| PE0402 | 0.65±0.10 | 1.15±0.10 | 8.00±0.30 | 1.75±0.10 | 3.50±0.10 | 4.00±0.10 | 2.00±0.05 | 2.00±0.05 | 1.50±0.10 | 0.53±0.10 | |
| PE0603 | 1.20±0.15 | 1.90±0.15 | 8.00±0.30 | 1.75±0.10 | 3.50±0.10 | 4.00±0.10 | 4.00±0.10 | 2.00±0.10 | 1.50±0.10 | 0.55±0.15 | |
| PE0805 | 1.60±0.15 | 2.30±0.15 | 8.00±0.30 | 1.75±0.10 | 3.50±0.10 | 4.00±0.10 | 4.00±0.10 | 2.00±0.10 | 1.50±0.10 | 0.85±0.15 | |
| PE1206 | 1.90±0.10 | 3.50±0.10 | 8.00±0.30 | 1.75±0.10 | 3.50±0.10 | 4.00±0.10 | 4.00±0.10 | 2.00±0.10 | 1.50±0.10 | 1.50±0.10 | |

EMBOSSED TAPE

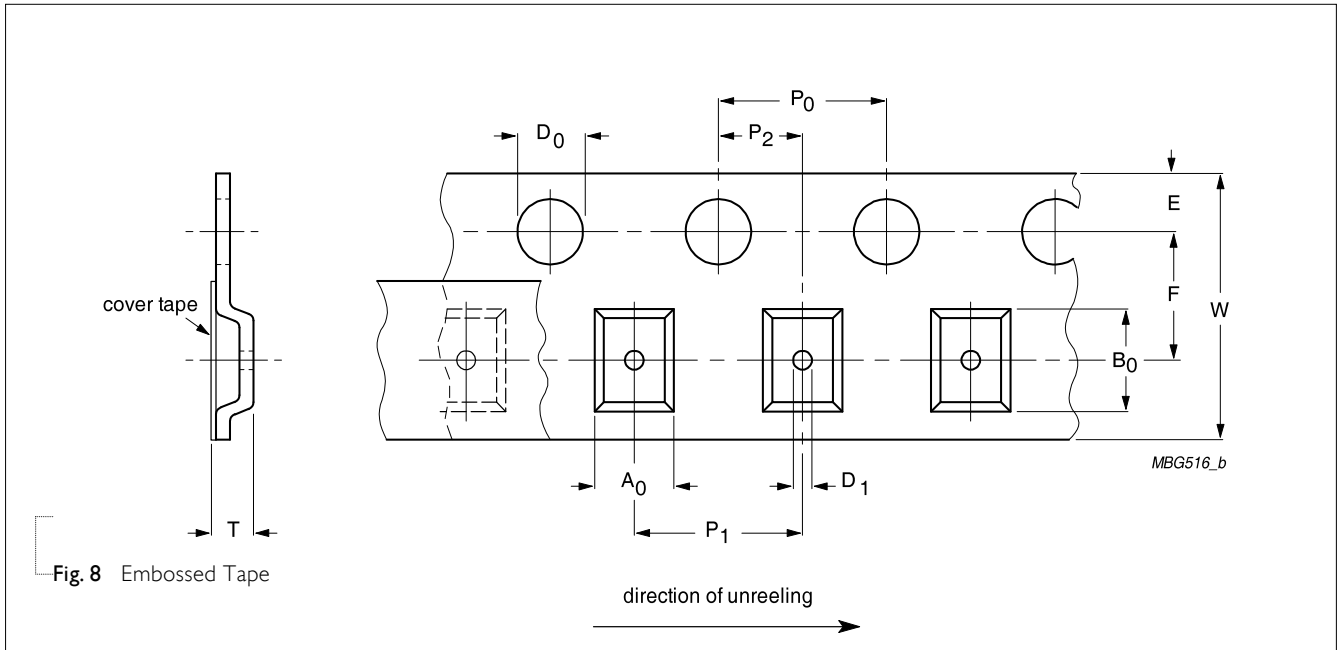

Fig. 8 Embossed Tape

Table 5 Dimensions of embossed tape for relevant chip resistors size

| SIZE | SYMBOL | | | | | | | | | | | Unit: mm |
|--------|-----------------|-----------------|------------------|-----------------|-----------------|-----------------|-----------------|-----------------|-------------------|-------------------|-----------------|----------|
| | A_0 | B_0 | W | E | F | P_0 | P_1 | P_2 | $\varnothing D_0$ | $\varnothing D_1$ | T | |
| PE2010 | 3.00 ± 0.15 | 5.60 ± 0.15 | 12.10 ± 0.30 | 1.75 ± 0.10 | 5.50 ± 0.10 | 4.00 ± 0.10 | 4.00 ± 0.10 | 2.00 ± 0.10 | 1.50 ± 0.10 | 1.50 ± 0.10 | 0.80 ± 0.15 | |
| PE2512 | 3.40 ± 0.15 | 6.70 ± 0.15 | 12.10 ± 0.30 | 1.75 ± 0.10 | 5.50 ± 0.10 | 4.00 ± 0.10 | 4.00 ± 0.10 | 2.00 ± 0.10 | 1.50 ± 0.10 | 1.50 ± 0.10 | 0.80 ± 0.15 | |

REEL SPECIFICATION

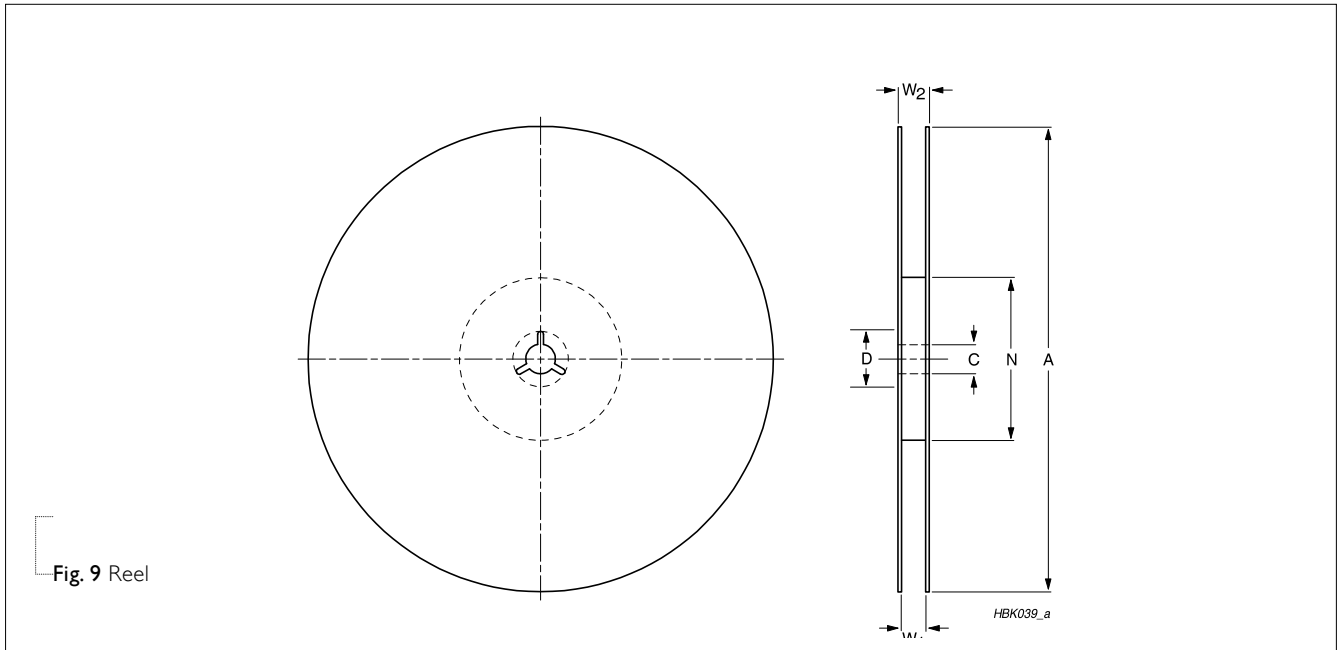

Fig. 9 Reel

Table 6 Dimensions of reel specification for relevant chip resistors size

| SIZE | QUANTITY PER REEL | REEL SIZE | | | SYMBOL | | Unit: mm | | | | |
|--------|-------------------|----------------|-----------------|-----------------|------------|-----------|----------|----------|------------|------------|--|
| | | 8 mm TAPE WIDE | 12 mm TAPE WIDE | 24 mm TAPE WIDE | A | N | C | D | W_1 | W_2 MAX. | |
| PE0201 | 10,000 | 7" (Ø178 mm) | --- | --- | 180.0+0/-3 | 60.0+1/-0 | 13.0±0.2 | 21.0±0.8 | 9.0±0.30 | 12.4 | |
| PE0402 | 10,000 | 7" (Ø178 mm) | --- | --- | 180.0+0/-3 | 60.0+1/-0 | 13.0±0.2 | 21.0±0.8 | 9.0±0.30 | 12.4 | |
| PE0603 | 5000 | 7" (Ø178 mm) | -- | -- | 180.0+0/-3 | 60.0+1/-0 | 13.0±0.2 | 21.0±0.8 | 8.4 +1/-0 | 12.4 | |
| PE0805 | 5000 | 7" (Ø178 mm) | -- | -- | 180.0+0/-3 | 60.0+1/-0 | 13.0±0.2 | 21.0±0.8 | 8.4 +1/-0 | 12.4 | |
| PE1206 | 4000 | 7" (Ø178 mm) | -- | -- | 180.0+0/-3 | 60.0+1/-0 | 13.0±0.2 | 21.0±0.8 | 8.4 +1/-0 | 12.4 | |
| PE2010 | 4000 | -- (Ø178 mm) | 7" | -- | 180.0+0/-3 | 60.0+1/-0 | 13.0±0.2 | 21.0±0.8 | 12.3 +1/-0 | 18.4 | |
| PE2512 | 4000 | -- (Ø178 mm) | 7" | -- | 180.0+0/-3 | 60.0+1/-0 | 13.0±0.2 | 21.0±0.8 | 12.3 +1/-0 | 18.4 | |

LEADER/TRAILER TAPE SPECIFICATION

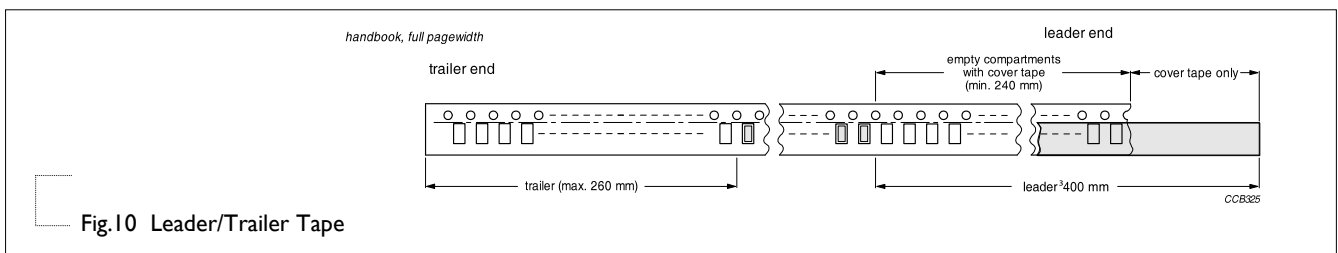

Fig.10 Leader/Trailer Tape

FOOTPRINT AND SOLDERING PROFILES

For recommended soldering profiles, please refer to data sheet “Chip resistors mounting”.

FOOTPRINT

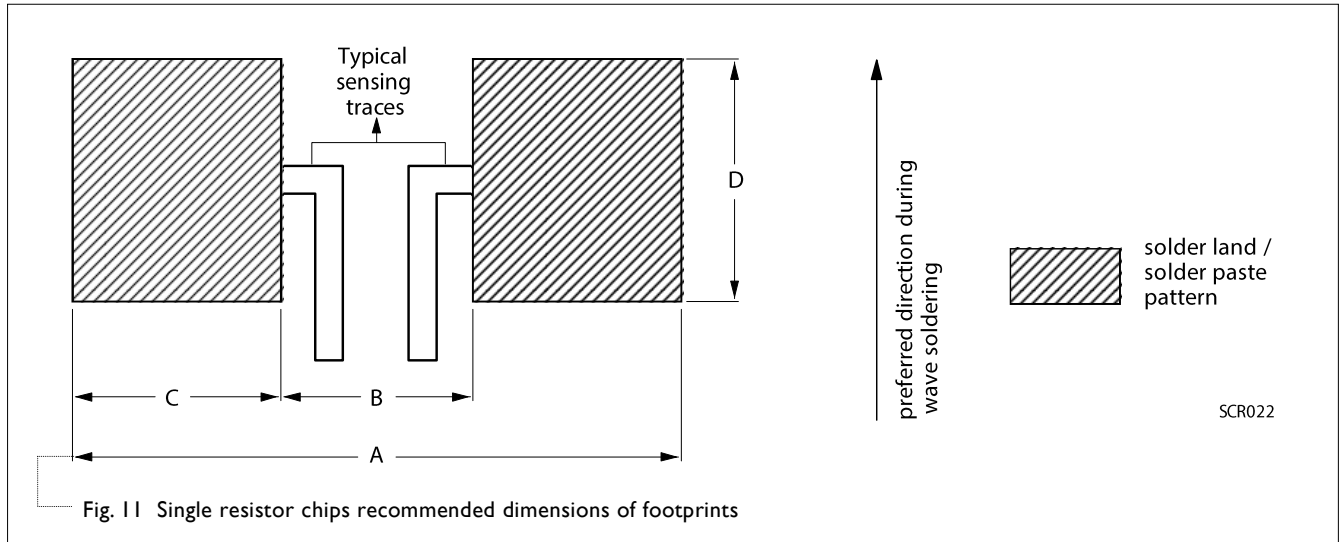

Table 7 Footprint dimensions

| SIZE | RESISTANCE RANGE | Unit: mm | | | |
|--------|---------------------------------------|----------|------|------|------|
| | | A | B | C | D |
| PE0201 | 50 mΩ ≤ R ≤ 200 mΩ | 1.00 | 0.30 | 0.35 | 0.40 |
| PE0402 | 10 mΩ ≤ R ≤ 910 mΩ | 1.45 | 0.35 | 0.55 | 0.55 |
| PE0603 | 5 mΩ, 10 mΩ, 15 mΩ, 20mΩ ≤ R ≤ 910 mΩ | 2.52 | 0.50 | 1.01 | 1.01 |
| PE0805 | 5 mΩ, 10 mΩ, 15 mΩ, 20mΩ ≤ R ≤ 910 mΩ | 2.54 | 0.50 | 1.02 | 1.27 |
| PE1206 | 5 mΩ ≤ R ≤ 910 mΩ | 3.90 | 0.76 | 1.57 | 1.78 |
| PE2010 | 5 mΩ ≤ R ≤ 6 mΩ | 6.12 | 1.40 | 2.36 | 3.05 |
| | 7 mΩ ≤ R ≤ 100 mΩ | 6.10 | 3.30 | 1.40 | 3.05 |
| PE2512 | 6 mΩ | 7.40 | 3.18 | 2.11 | 3.68 |
| | 7 mΩ ≤ R ≤ 100 mΩ | 7.36 | 4.06 | 1.65 | 3.68 |

TESTS AND REQUIREMENTS
Table 8 Test condition, procedure and requirements

| TEST | TEST METHOD | PROCEDURE | REQUIREMENTS |
|---|---|--|-------------------------------------|
| Life/ Operational Life/ Endurance | MIL-STD-202G-method 108 IEC 60115-1 4.25.1 | 1,000 hours at 70±2 °C applied RCWV 1.5 hours on, 0.5 hour off, still air required | ±(1%+0.0005 Ω) |
| High Temperature Exposure/ Endurance at Upper Category Temperature | MIL-STD-202G-method 108 IEC 60115-1 4.25.3 | 1,000 hours at maximum operating temperature depending on specification, unpowered No direct impingement of forced air to the parts Tolerances: 0201/0402 155±3°C 0603 and above 170±3°C | ±(1%+0.0005 Ω) |
| Moisture Resistance | MIL-STD-202G-method 106 | Each temperature / humidity cycle is defined at 8 hours (method 106F), 3 cycles / 24 hours for 10d with 25 °C / 65 °C 95% R.H, without steps 7a & 7b, unpowered Parts mounted on test-boards, without condensation on parts Measurement at 24±2 hours after test conclusion | ±(0.5%+0.0005 Ω) |
| Thermal Shock | MIL-STD-202G-method 107 | -55/+125 °C Note: Number of cycles required is 300. Devices mounted Maximum transfer time is 20 seconds. Dwell time is 15 minutes. Air – Air | ±(1%+0.0005 Ω) |
| Short Time Overload | IEC60115-1 4.13 | 5 times of rated power for 5 seconds at room temperature | ±(1%+0.0005 Ω) No visible damage |
| Board Flex/ Bending | IEC60115-1 4.33 | Device mounted on PCB test board as described, only 1 board bending required Bending for 0201: 3mm 0402 and above: 2mm Holding time: minimum 60 seconds | ±(1%+0.0005 Ω) No visible damage |
| Biased Humidity | MIL-STD-202 Method 103 | 1,000 hours at 85°C/85%R.H. 10% of operating power, no condensation on the devices, circulating air. | ± (1.0 % + 0.0005Ω) |

| TEST | TEST METHOD | PROCEDURE | REQUIREMENTS |
|-----------------------------------|--------------------------------|--|----------------------------|
| Solderability - Wetting | IPC/JEDEC | Electrical Test not required | Well tinned (≥95% covered) |
| | J-STD-002B test B | Magnification 50X SMD conditions: 1 st step: method B, aging 4 hours at 155 °C dry heat 2 nd step: leadfree solder bath at 245±3 °C Dipping time: 3±0.5 seconds | No visible damage |
| - Leaching | IPC/JEDEC J-STD-002B test D | Leadfree solder, 260 °C, 30 seconds immersion time | No visible damage |
| - Resistance to Soldering Heat | MIL-STD-202G-method 210F | Condition B, no pre-heat of samples | ±(0.5%+0.0005 Ω) |
| | IEC 60115-1 4.18 | Leadfree solder, 260 °C, 10 seconds immersion time Procedure 2 for SMD: devices fluxed and cleaned with isopropanol | No visible damage |

REVISION HISTORY

| REVISION | DATE | CHANGE NOTIFICATION | DESCRIPTION |
|-----------|---------------|---------------------|--|
| Version 5 | Nov 23,2016 | - | - Extend resistor value for 0.5% |
| Version 4 | Dec. 21, 2015 | - | - Update resistance value |
| Version 3 | Aug. 06, 2015 | - | - Update 0603 to 1206 TCR |
| Version 2 | Apr. 20, 2015 | - | - Extend resistor value |
| Version 1 | Mar. 04, 2015 | - | - Update TCR and operating temperature |
| Version 0 | Feb. 10, 2015 | - | - New datasheet for current sensor - low TCR PE series sizes of 0201/0402/0603/0805/1206/2010/2512, 0.5%, 1%, and 5% |

“Yageo reserves all the rights for revising the content of this datasheet without further notification, as long as the products itself are unchanged. Any product change will be announced by PCN.”

Mouser Electronics

Authorized Distributor

Click to View Pricing, Inventory, Delivery & Lifecycle Information:

Yageo:

[PE2512FKE7W0R025L](#) [PE2512FKE7W0R02L](#) [PE2512FKE7W0R033L](#) [PE2512FKE7W0R03L](#)
[PE2512FKE7W0R04L](#) [PE2512FKE7W0R06L](#) [PE0805FRF470R01L](#) [PE2512FKE070R006L](#) [PE2512FKE070R007L](#)
[PE2512FKE070R008L](#) [PE2512FKE070R009L](#) [PE2512FKE070R015L](#) [PE2512FKE070R01L](#) [PE2512FKE070R02L](#)
[PE2512FKE070R033L](#) [PE2512FKE070R03L](#) [PE2512FKE070R04L](#) [PE2512FKE070R05L](#) [PE2512FKE070R07L](#)
[PE2512FKE070R08L](#) [PE2512FKE070R1L](#) [PE2512FKE7W0R006L](#) [PE2512FKE7W0R007L](#) [PE2512FKE7W0R008L](#)
[PE2512FKE7W0R009L](#) [PE2512FKE7W0R012L](#) [PE2512FKE7W0R015L](#) [PE2512FKE7W0R018L](#)
[PE2512FKE7W0R01L](#) [PE2512FKE7W0R022L](#) [PE0805FRF470R05L](#) [PE0805FRM7W0R033L](#) [PE0603FRF070R015L](#)
[PE0603FRF070R025L](#) [PE0603FRF070R02L](#) [PE0603FRF070R04L](#) [PE0603FRF070R05L](#) [PE0603FRF070R1L](#)
[PE0603FRF470R1L](#) [PE0603FRF7W0R04L](#) [PE0603FRF7W0R1L](#) [PE0603FRM570R01L](#) [PE0805FRF070R015L](#)
[PE0805FRF070R01L](#) [PE0805FRF070R025L](#) [PE0805FRF070R02L](#) [PE0805FRF070R033L](#) [PE0805FRF070R03L](#)
[PE0805FRF070R047L](#) [PE0805FRF070R04L](#) [PE0805FRF070R05L](#) [PE0805FRF070R15L](#) [PE0805FRF070R1L](#)
[PE0805FRF470R017L](#) [PE0805FRF470R025L](#) [PE0805FRF7W0R005L](#) [PE0805FRF7W0R01L](#) [PE0805FRF7W0R02L](#)
[PE0805FRF7W0R033L](#) [PE0805FRF7W0R03L](#) [PE0805FRF7W0R04L](#) [PE0805FRF7W0R15L](#) [PE0805FRF7W0R1L](#)
[PE0805FRF7W0R2L](#) [PE0805FRM470R02L](#) [PE1206FRF070R005L](#) [PE1206FRF070R006L](#) [PE1206FRF070R008L](#)
[PE1206FRF070R012L](#) [PE1206FRF070R015L](#) [PE1206FRF070R01L](#) [PE1206FRF070R022L](#) [PE1206FRF070R025L](#)
[PE1206FRF070R02L](#) [PE1206FRF070R033L](#) [PE1206FRF070R039L](#) [PE1206FRF070R03L](#) [PE1206FRF070R047L](#)
[PE1206FRF070R04L](#) [PE1206FRF070R056L](#) [PE1206FRF070R05L](#) [PE1206FRF070R068L](#) [PE1206FRF070R06L](#)
[PE1206FRF070R075L](#) [PE1206FRF070R15L](#) [PE1206FRF070R18L](#) [PE1206FRF470R005L](#) [PE1206FRF470R01L](#)
[PE1206FRF470R022L](#) [PE1206FRF470R02L](#) [PE1206FRF470R033L](#) [PE1206FRF470R03L](#) [PE1206FRF470R05L](#)
[PE1206FRF7W0R015L](#) [PE1206FRF7W0R01L](#) [PE1206FRF7W0R025L](#) [PE1206FRF7W0R02L](#)
[PE1206FRF7W0R033L](#) [PE1206FRF7W0R03L](#) [PE1206FRF7W0R04L](#)



Компания «ЭлектроПласт» предлагает заключение долгосрочных отношений при поставках импортных электронных компонентов на взаимовыгодных условиях!

Наши преимущества:

- Оперативные поставки широкого спектра электронных компонентов отечественного и импортного производства напрямую от производителей и с крупнейших мировых складов;
- Поставка более 17-ти миллионов наименований электронных компонентов;
- Поставка сложных, дефицитных, либо снятых с производства позиций;
- Оперативные сроки поставки под заказ (от 5 рабочих дней);
- Экспресс доставка в любую точку России;
- Техническая поддержка проекта, помощь в подборе аналогов, поставка прототипов;
- Система менеджмента качества сертифицирована по Международному стандарту ISO 9001;
- Лицензия ФСБ на осуществление работ с использованием сведений, составляющих государственную тайну;
- Поставка специализированных компонентов (Xilinx, Altera, Analog Devices, Intersil, Interpoint, Microsemi, Aeroflex, Peregrine, Syfer, Eurofarad, Texas Instrument, Miteq, Cobham, E2V, MA-COM, Hittite, Mini-Circuits, General Dynamics и др.);

Помимо этого, одним из направлений компании «ЭлектроПласт» является направление «Источники питания». Мы предлагаем Вам помощь Конструкторского отдела:

- Подбор оптимального решения, техническое обоснование при выборе компонента;
- Подбор аналогов;
- Консультации по применению компонента;
- Поставка образцов и прототипов;
- Техническая поддержка проекта;
- Защита от снятия компонента с производства.



Как с нами связаться

Телефон: 8 (812) 309 58 32 (многоканальный)

Факс: 8 (812) 320-02-42

Электронная почта: org@eplast1.ru

Адрес: 198099, г. Санкт-Петербург, ул. Калинина, дом 2, корпус 4, литера А.