

### FEATURES

- Low offset voltage:** 60  $\mu\text{V}$  maximum at 25°C (8-lead and 14-lead SOIC)
- Low offset voltage drift:** 1  $\mu\text{V}/^\circ\text{C}$  maximum (8-lead and 14-lead SOIC)
- Low input bias current:** 1 nA maximum at 25°C
- Low voltage noise density:** 8 nV/ $\sqrt{\text{Hz}}$  typical at 1 kHz
- Large signal voltage gain ( $A_{\text{VO}}$ ):** 100 dB minimum over full supply voltage and operating temperature
- Input overvoltage protection to 32 V above and below the supply voltage rail**
- Integrated EMI filter**
  - 70 dB typical rejection at 1000 MHz
  - 90 dB typical rejection at 2400 MHz
- Rail-to-rail output swing**
- Low supply current:** 500  $\mu\text{A}$  typical per amplifier
- Wide bandwidth**
  - Gain bandwidth product ( $A_{\text{V}} = +100$ ): 3.5 MHz typical
  - Unity-gain crossover ( $A_{\text{V}} = +1$ ): 3.5 MHz typical
  - 3 dB bandwidth ( $A_{\text{V}} = +1$ ): 6 MHz typical
- Dual-supply operation**
  - Specified at  $\pm 5\text{ V}$  to  $\pm 15\text{ V}$ , operates over  $\pm 2.5\text{ V}$  to  $\pm 18\text{ V}$
- Unity-gain stable**
- No phase reversal**

### APPLICATIONS

- Wireless base station control circuits
- Optical network control circuits
- Instrumentation
- Sensors and controls
  - Thermocouples, resistor thermal detectors (RTDs), strain gages, shunt current measurements
- Precision filters

### GENERAL DESCRIPTION

The ADA4177-1 single channel, ADA4177-2 dual channel, and ADA4177-4 quad channel amplifiers feature low offset voltage (2  $\mu\text{V}$  typical) and drift (1  $\mu\text{V}/^\circ\text{C}$  maximum), low input bias current, low noise, and low current consumption (500  $\mu\text{A}$  typical). Outputs are stable with capacitive loads of more than 1000 pF with no external compensation.

The inputs of the ADA4177-1, ADA4177-2, and ADA4177-4 set a new standard in precision amplifier robustness, providing input protection against signal excursions 32 V beyond either supply, as well as 70 dB of rejection for electromagnetic interference (EMI) at 1000 MHz.

### PIN CONNECTION DIAGRAM

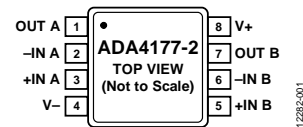

Figure 1. ADA4177-2

Applications for this amplifier include sensor signal conditioning (such as thermocouples, RTDs, and strain gages), process control front-end amplifiers, and precision diode power measurement in optical and wireless transmission systems.

The ADA4177-2 and ADA4177-4 operate over the  $-40^\circ\text{C}$  to  $+125^\circ\text{C}$  industrial temperature range. The ADA4177-1 and the ADA4177-2 are available in an 8-lead SOIC package and an 8-lead MSOP package. The ADA4177-4 is available in a 14-lead TSSOP and a 14-lead SOIC package.

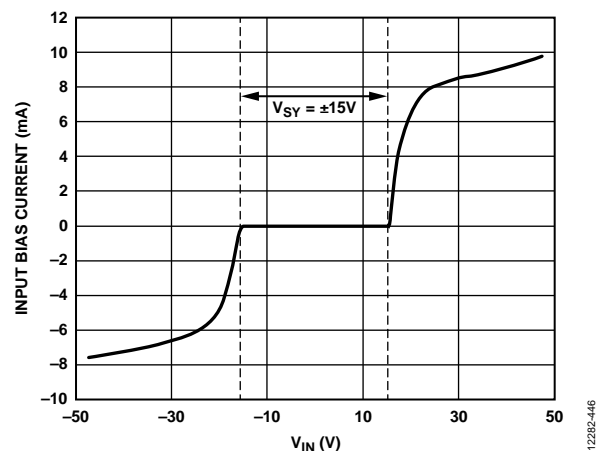

Figure 2. Overvoltage Current Limiting, Voltage Follower Configuration

 Table 1. Evolution of Protected Input Op Amps by Generation<sup>1</sup>

Gen. 1, OVP (10 V)	Gen. 2, OVP (25 V)	Gen. 3, OVP (32 V)	Gen. 4 EMI Filters	Gen. 5, OVP (32 V) + EMI
OP191	ADA4091-2	ADA4096-2	AD8657	ADA4177-1
OP291	ADA4091-4	ADA4096-4	AD8659	ADA4177-2
OP491	ADA4092-4		AD8546 AD8548 ADA4661-2 ADA4666-2	ADA4177-4

<sup>1</sup> Gen. stands for Generation.

**TABLE OF CONTENTS**

Features ..... 1  
 Applications..... 1  
 General Description ..... 1  
 Pin Connection Diagram ..... 1  
 Revision History ..... 2  
 Specifications..... 3  
     Electrical Characteristics,  $\pm 5$  V ..... 3  
     Electrical Characteristics,  $\pm 15$  V ..... 5  
     Absolute Maximum Ratings ..... 7  
     Maximum Power Dissipation ..... 7  
     Thermal Resistance ..... 7  
     ESD Caution..... 7  
 Pin Configurations and Function Descriptions ..... 8  
 Typical Performance Characteristics ..... 11

Theory of Operation ..... 24  
 Applications Information ..... 25  
     Active Overvoltage Protection ..... 25  
     Limiting Overvoltage Current Out of the Positive Supply Pin.. 26  
     EMI Protection ..... 27  
     Self Heating ..... 27  
     Using the ADA4177-1/ADA4177-2/ADA4177-4 as a  
     Comparator ..... 27  
     Output Phase Reversal..... 28  
     Proper Printed Circuit Board (PCB) Layout ..... 28  
 Outline Dimensions ..... 29  
     Ordering Guide ..... 31

**REVISION HISTORY**

**4/15—Rev. B to Rev. C**

Added ADA4177-1 ..... Universal  
 Deleted Figure 2; Renumbered Sequentially..... 1  
 Change to Table 1 ..... 1  
 Added Figure 5, Figure 6, and Table 7; Renumbered  
 Sequentially ..... 9  
 Changes to Figure 16, Figure 17, Figure 19, and Figure 20 ..... 12  
 Changes to Figure 26..... 14  
 Changes to Figure 34, Figure 35, Figure 37, and Figure 39 ..... 16  
 Changes to Figure 46, Figure 47, Figure 49, and Figure 50 ..... 17  
 Changes to Figure 59 and Figure 62..... 19  
 Changes to Figure 63, Figure 65, Figure 66, and Figure 68 ..... 20  
 Changes to Figure 69 and Figure 72..... 21  
 Changes to Figure 75 and Figure 78..... 22  
 Added Figure 77 and Figure 80 ..... 22  
 Added Figure 81 to Figure 83 ..... 23  
 Changes to Theory of Operation Section..... 24  
 Changes to Input Protection Circuit Section and Limiting  
 Overvoltage Current Out of the Positive Supply Pin Section... 26  
 Changes to Using the ADA4177-1/ADA4177-2/ADA4177-4 as  
 a Comparator Section ..... 27  
 Changes to Ordering Guide ..... 31

Added Figure 2; Renumbered Sequentially .....1  
 Changes to Features and General Description Section .....1  
 Changes to Table 2.....3  
 Changes to Table 3.....5  
 Changes to Table 5.....7  
 Added Figure 6, Figure 7, and Table 7; Renumbered  
 Sequentially ..... 9  
 Added Figure 10 and Figure 13.....10  
 Replaced Figure 15 and Figure 18.....11  
 Added Figure 14, Figure 16, Figure 17,and Figure 19.....11  
 Changes to Figure 20, Figure 21, Figure 23, and Figure 24.....12  
 Changes to Figure 32 and Figure 33.....14  
 Changes to Figure 38 and Figure 41 .....15  
 Changes to Figure 58 and Figure 61 .....18  
 Changes to Figure 62, Figure 65, and Figure 66.....19  
 Changes to Figure 69 and Figure 72.....20  
 Change to Figure 87 Caption ..... 25  
 Updated Outline Dimensions ..... 27  
 Added Figure 93 and Figure 94 ..... 28  
 Changes to Ordering Guide ..... 29

**10/14—Rev. 0 to Rev. A**

Changes to Large Signal Voltage Gain Parameter, Test  
 Conditions/Comments Column, Table 3 .....5

**10/14—Revision 0: Initial Version**

**1/15—Rev. A to Rev. B**

Added ADA4177-4 ..... Universal  
 Reorganized Layout..... Universal

## SPECIFICATIONS

ELECTRICAL CHARACTERISTICS,  $\pm 5$  V

$V_{SY} = \pm 5.0$  V,  $V_{CM} = 0$  V,  $T_A = 25^\circ\text{C}$ , unless otherwise noted.

Table 2.

Parameter	Symbol	Test Conditions/Comments	Min	Typ	Max	Unit				
INPUT CHARACTERISTICS										
Offset Voltage	$V_{OS}$	$-40^\circ\text{C} < T_A < +125^\circ\text{C}$		2	60	$\mu\text{V}$				
8-Lead SOIC and 14-Lead SOIC					120	$\mu\text{V}$				
8-Lead MSOP					120	$\mu\text{V}$				
14-Lead TSSOP					200	$\mu\text{V}$				
				3	150	$\mu\text{V}$				
				3	300	$\mu\text{V}$				
Offset Voltage Matching					40	$\mu\text{V}$				
8-Lead SOIC					110	$\mu\text{V}$				
8-Lead MSOP										
Offset Voltage Drift	$\Delta V_{OS}/\Delta T$	$-40^\circ\text{C} < T_A < +125^\circ\text{C}$			1	$\mu\text{V}/^\circ\text{C}$				
8-Lead SOIC and 14-Lead SOIC					1.6	$\mu\text{V}/^\circ\text{C}$				
8-Lead MSOP and 14-Lead TSSOP										
Input Bias Current	$I_B$	$-40^\circ\text{C} < T_A < +125^\circ\text{C}$		-1	-0.4	+1	nA			
					-2	+2	nA			
Input Offset Current	$I_{OS}$	$-40^\circ\text{C} < T_A < +125^\circ\text{C}$		-0.75	0.1	+0.75	nA			
					-1.5	+1.5	nA			
					-3.5	+3.5	V			
Input Voltage Range	IVR									
Overvoltage Current Limit <sup>1</sup>	$I_{OVP}$	$5\text{ V} < V_{CM} < 37\text{ V}$ $-37\text{ V} < V_{CM} < -5\text{ V}$			12		mA			
					10		mA			
Common-Mode Rejection Ratio	CMRR	$V_{CM} = -3.5\text{ V to } +3.5\text{ V}$ $-40^\circ\text{C} < T_A < +125^\circ\text{C}$			122	130	dB			
					120		dB			
Large Signal Voltage Gain	$A_{VO}$	$R_L = 2\text{ k}\Omega, V_{OUT} = -4.5\text{ V to } +4.5\text{ V}$ $-40^\circ\text{C} < T_A < +125^\circ\text{C}$			108	110	dB			
					100		dB			
					115	120	dB			
					110		dB			
Input Capacitance	$C_{INDM}$	Differential mode		1		pF				
	$C_{INCM}$	Common mode		1		pF				
	Input Resistance	$R_{DIFF}$	Differential mode		4		M $\Omega$			
$R_{CM}$		Common mode		100		G $\Omega$				
OUTPUT CHARACTERISTICS										
Output Voltage	$V_{OH}$	$I_{LOAD} = 1\text{ mA}$ $-40^\circ\text{C} < T_A < +125^\circ\text{C}$			4.95		V			
High					4.90		V			
					4.80		V			
					4.75		V			
Low					$V_{OL}$	$I_{LOAD} = 1\text{ mA}$ $-40^\circ\text{C} < T_A < +125^\circ\text{C}$			-4.95	V
						$I_{LOAD} = 7\text{ mA}$ $-40^\circ\text{C} < T_A < +125^\circ\text{C}$			-4.90	V
		$I_{LOAD} = 7\text{ mA}$ $-40^\circ\text{C} < T_A < +125^\circ\text{C}$			-4.80	V				
		$I_{LOAD} = 7\text{ mA}$ $-40^\circ\text{C} < T_A < +125^\circ\text{C}$			-4.75	V				
Output Current	$I_{OUT}$	$V_{DROPOUT} < 1\text{ V}$		25		mA				
Short-Circuit Current	$I_{SC}$	$T_A = 25^\circ\text{C}$								
Sourcing					36		mA			
Sinking					48		mA			
Closed-Loop Output Impedance	$Z_{OUT}$	$f = 1\text{ kHz}, A_V = +1$		0.11		$\Omega$				

Parameter	Symbol	Test Conditions/Comments	Min	Typ	Max	Unit
<b>POWER SUPPLY</b>						
Power Supply Rejection Ratio	PSRR	$V_S = \pm 2.5\text{ V to } \pm 18\text{ V}$ $-40^\circ\text{C} < T_A < +125^\circ\text{C}$	125	145		dB
Supply Current per Amplifier	$I_{SY}$	$V_{OUT} = 0\text{ V}$ $-40^\circ\text{C} < T_A < +125^\circ\text{C}$	120	500	560	$\mu\text{A}$
					600	$\mu\text{A}$
<b>DYNAMIC PERFORMANCE</b>						
Slew Rate	SR	$R_L = 2\text{ k}\Omega$		1.5		$\text{V}/\mu\text{s}$
Settling Time	$t_s$					
To 0.1%		$V_{IN} = 1\text{ V step, } R_L = 2\text{ k}\Omega, A_V = -1$		1.8		$\mu\text{s}$
To 0.01%		$V_{IN} = 1\text{ V step, } R_L = 2\text{ k}\Omega, A_V = -1$		3.5		$\mu\text{s}$
Gain Bandwidth Product	GBP	$V_{IN} = 10\text{ mV p-p, } R_L = 2\text{ k}\Omega, A_V = +100$		3.5		MHz
Unity-Gain Crossover	UGC	$V_{IN} = 10\text{ mV p-p, } R_L = 2\text{ k}\Omega, A_V = +1$		3.5		MHz
-3 dB Closed-Loop Bandwidth	$f_{-3\text{dB}}$	$V_{IN} = 10\text{ mV p-p, } R_L = 2\text{ k}\Omega, A_V = +1$		6		MHz
Total Harmonic Distortion Plus Noise	THD + N	$V_{IN} = 1\text{ V rms, } R_L = 2\text{ k}\Omega, A_V = +1, f = 1\text{ kHz}$		0.003		%
EMI Rejection of +IN x	EMIRR	$V_{IN} = 200\text{ mV p-p}$				
f = 1000 MHz				70		dB
f = 2400 MHz				90		dB
<b>NOISE PERFORMANCE</b>						
Voltage Noise	$e_{n\text{ p-p}}$	0.1 Hz to 10 Hz		175		nV p-p
Voltage Noise Density	$e_n$	f = 10 Hz		10		$\text{nV}/\sqrt{\text{Hz}}$
		f = 1 kHz		8		$\text{nV}/\sqrt{\text{Hz}}$
Current Noise Density	$i_n$	f = 1 kHz		0.2		$\text{pA}/\sqrt{\text{Hz}}$

<sup>1</sup> All inputs are stressed to 32 V beyond supplies for 500 ms. See Figure 71 for the typical input bias current vs. the input voltage over the overvoltage protected input range.

**ELECTRICAL CHARACTERISTICS,  $\pm 15$  V**

$V_{SY} = \pm 15$  V,  $V_{CM} = 0$  V,  $T_A = 25^\circ\text{C}$ , unless otherwise noted.

**Table 3.**

Parameter	Symbol	Test Conditions/Comments	Min	Typ	Max	Unit			
<b>INPUT CHARACTERISTICS</b>									
Offset Voltage	$V_{OS}$	$-40^\circ\text{C} < T_A < +125^\circ\text{C}$		2	60	$\mu\text{V}$			
8-Lead SOIC and 14-Lead SOIC					120	$\mu\text{V}$			
8-Lead MSOP					3	120	$\mu\text{V}$		
14-Lead TSSOP					200	$\mu\text{V}$			
					3	150	$\mu\text{V}$		
					300	$\mu\text{V}$			
Offset Voltage Matching	$\Delta V_{OS}/\Delta T$	$-40^\circ\text{C} < T_A < +125^\circ\text{C}$			40	$\mu\text{V}$			
8-Lead SOIC					110	$\mu\text{V}$			
8-Lead MSOP									
Offset Voltage Drift	$\Delta V_{OS}/\Delta T$	$-40^\circ\text{C} < T_A < +125^\circ\text{C}$			1	$\mu\text{V}/^\circ\text{C}$			
8-Lead SOIC and 14-Lead SOIC					1.6	$\mu\text{V}/^\circ\text{C}$			
8-Lead MSOP and 14-Lead TSSOP									
Input Bias Current	$I_B$	$-40^\circ\text{C} < T_A < +125^\circ\text{C}$		-1	-0.3	+1	nA		
					-2	+2	nA		
Input Offset Current	$I_{OS}$	$-40^\circ\text{C} < T_A < +125^\circ\text{C}$		-0.75	0.1	+0.75	nA		
					-1.5	+1.5	nA		
Input Voltage Range	IVR					+13.5	V		
Overvoltage Current Limit <sup>1</sup>	$I_{OVP}$	$15\text{ V} < V_{CM} < 47\text{ V}$			12		mA		
		$-47\text{ V} < V_{CM} < -15\text{ V}$			10		mA		
Common-Mode Rejection Ratio	CMRR	$V_{CM} = -13.5\text{ V to } +13.5\text{ V}$	128	130			dB		
		$-40^\circ\text{C} < T_A < +125^\circ\text{C}$	125				dB		
Large Signal Voltage Gain	$A_{VO}$	$R_L = 2\text{ k}\Omega, V_{OUT} = -14.2\text{ V to } +14.2\text{ V}$	$-40^\circ\text{C} < T_A < +125^\circ\text{C}$		110	114	dB		
							103	dB	
							118	120	dB
									110
Input Capacitance	$C_{INDM}$	Differential mode		1		pF			
	$C_{INCM}$	Common mode		1		pF			
Input Resistance	$R_{DIFF}$	Differential mode		4		M $\Omega$			
	$R_{CM}$	Common mode		130		G $\Omega$			
<b>OUTPUT CHARACTERISTICS</b>									
Output Voltage	$V_{OH}$	$I_{LOAD} = 1\text{ mA}$	$-40^\circ\text{C} < T_A < +125^\circ\text{C}$		14.95		V		
High					14.90		V		
					14.80		V		
					14.75		V		
Low	$V_{OL}$	$I_{LOAD} = 1\text{ mA}$	$-40^\circ\text{C} < T_A < +125^\circ\text{C}$			-14.95	V		
						-14.90	V		
						-14.80	V		
						-14.75	V		
Output Current	$I_{OUT}$	$V_{DROPOUT} < 1\text{ V}$			25		mA		
Short-Circuit Current	$I_{SC}$	$T_A = 25^\circ\text{C}$							
Sourcing							53	mA	
Sinking							65	mA	
Closed-Loop Output Impedance	$Z_{OUT}$	$f = 1\text{ kHz}, A_V = +1$			0.08		$\Omega$		

Parameter	Symbol	Test Conditions/Comments	Min	Typ	Max	Unit
<b>POWER SUPPLY</b>						
Power Supply Rejection Ratio	PSRR	$V_S = \pm 2.5\text{ V to } \pm 18\text{ V}$ $-40^\circ\text{C} < T_A < +125^\circ\text{C}$	125	145		dB
Supply Current per Amplifier	$I_{SY}$	$V_{OUT} = 0\text{ V}$ $-40^\circ\text{C} < T_A < +125^\circ\text{C}$	120	500	580 620	$\mu\text{A}$ $\mu\text{A}$
<b>DYNAMIC PERFORMANCE</b>						
Slew Rate	SR	$R_L = 2\text{ k}\Omega$		1.5		$\text{V}/\mu\text{s}$
Settling Time	$t_s$					
To 0.1%		$V_{IN} = 10\text{ V p-p}, R_L = 2\text{ k}\Omega, A_V = -1$		5.5		$\mu\text{s}$
To 0.01%		$V_{IN} = 10\text{ V p-p}, R_L = 2\text{ k}\Omega, A_V = -1$		7.5		$\mu\text{s}$
Gain Bandwidth Product	GBP	$V_{IN} = 10\text{ mV p-p}, R_L = 2\text{ k}\Omega, A_V = +100$		3.5		MHz
Unity-Gain Crossover	UGC	$V_{IN} = 10\text{ mV p-p}, R_L = 2\text{ k}\Omega, A_V = +1$		3.5		MHz
-3 dB Closed-Loop Bandwidth	$f_{-3\text{ dB}}$	$V_{IN} = 10\text{ mV p-p}, R_L = 2\text{ k}\Omega, A_V = +1$		6		MHz
Total Harmonic Distortion Plus Noise	THD + N	$V_{IN} = 1\text{ V rms}, A_V = +1, R_L = 2\text{ k}\Omega, f = 1\text{ kHz}$		0.002		%
EMI Rejection of +IN x	EMIRR	$V_{IN} = 200\text{ mV p-p}$				
f = 1000 MHz				70		dB
f = 2400 MHz				90		dB
<b>NOISE PERFORMANCE</b>						
Voltage Noise	$e_{n\text{ p-p}}$	0.1 Hz to 10 Hz		175		nV p-p
Voltage Noise Density	$e_n$	f = 10 Hz		10		$\text{nV}/\sqrt{\text{Hz}}$
		f = 1 kHz		8		$\text{nV}/\sqrt{\text{Hz}}$
Current Noise Density	$i_n$	f = 1 kHz		0.2		$\text{pA}/\sqrt{\text{Hz}}$
MULTIPLE AMPLIFIERS CHANNEL SEPARATION	$C_S$	f = 1 kHz		127		dB

<sup>1</sup> All inputs are stressed to 32 V beyond supplies for 500 ms. See Figure 74 for the typical input bias current vs. the input voltage over the overvoltage protected input range.

**ABSOLUTE MAXIMUM RATINGS**

Table 4.

Parameter	Rating
Supply Voltage	36 V
Input Voltage	$V_{SY} \pm 32$ V
Differential Input Voltage	$\pm V_{SY}$
Output Short-Circuit Duration to GND	See the Maximum Power Dissipation section
Storage Temperature Range	-65°C to +150°C
Operating Temperature Range	-40°C to +125°C
Junction Temperature Range	-65°C to +150°C
Lead Temperature, Soldering (10 sec) <sup>1</sup>	300°C
ESD	
Human Body Model (HBM) <sup>2</sup>	4 kV
Field Induced Charged Device Model (FICDM) <sup>3</sup>	1250 V
Machine Model (MM)	200 V

<sup>1</sup> IPC/JEDEC J-STS-020D applicable standard.

<sup>2</sup> ESDA/JEDEC JS-001-2011 applicable standard.

<sup>3</sup> JESD22-C101 (ESD FICDM standard of JEDEC) applicable standard.

Stresses at or above those listed under Absolute Maximum Ratings may cause permanent damage to the product. This is a stress rating only; functional operation of the product at these or any other conditions above those indicated in the operational section of this specification is not implied. Operation beyond the maximum operating conditions for extended periods may affect product reliability.

**MAXIMUM POWER DISSIPATION**

The ADA4177-1, ADA4177-2, and ADA4177-4 can drive a short-circuit output current of up to 65 mA. However, the usable output load current drive is limited by the maximum power dissipation allowed by the device package. The absolute maximum junction temperature is 150°C (see Table 4). The junction temperature can be estimated as follows:

$$T_j = P_D \times \theta_{JA} + T_A$$

where:

$T_j$  is the die junction temperature.

$P_D$  is the power dissipated in the package.

$\theta_{JA}$  is the thermal resistance of the package.

$T_A$  is the ambient temperature.

The power dissipated in the package ( $P_D$ ) is the sum of the quiescent power dissipation and the power dissipated by the output stage transistor. It is calculated as follows:

$$P_D = (V_{SY} \times I_{SY}) + (V_{SY} - V_{OUT}) \times I_{LOAD}$$

where:

$V_{SY}$  is the power supply rail.

$I_{SY}$  is the quiescent current.

$V_{OUT}$  is the output of the amplifier.

$I_{LOAD}$  is the output load.

Do not exceed the 150°C maximum junction temperature for the device. Exceeding the junction temperature limit can cause degradation in the parametric performance or even destroy the device. Refer to [Technical Article MS-2251, Data Sheet Intricacies—Absolute Maximum Ratings and Thermal Resistances](#), for more information.

**THERMAL RESISTANCE**

Thermal resistance between junction and ambient ( $\theta_{JA}$ ) is specified for the worst-case conditions, that is, a device soldered in a circuit board for surface-mount packages.

Table 5. Thermal Resistance

Package Type	$\theta_{JA}$	$\theta_{JC}$	Unit
8-Lead MSOP	190	44	°C/W
8-Lead SOIC	158	43	°C/W
14-Lead TSSOP	240	43	°C/W
14-Lead SOIC	115	36	°C/W

**ESD CAUTION**

**ESD (electrostatic discharge) sensitive device.** Charged devices and circuit boards can discharge without detection. Although this product features patented or proprietary protection circuitry, damage may occur on devices subjected to high energy ESD. Therefore, proper ESD precautions should be taken to avoid performance degradation or loss of functionality.

## PIN CONFIGURATIONS AND FUNCTION DESCRIPTIONS

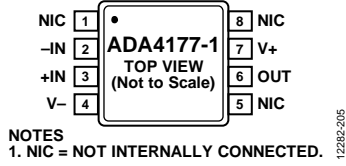

Figure 3. 8-Lead MSOP Pin Configuration, [ADA4177-1](#)

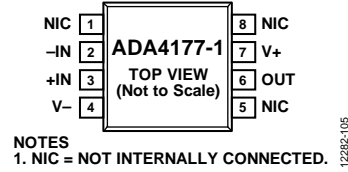

Figure 4. 8-Lead SOIC Pin Configuration, [ADA4177-1](#)

Table 6. [ADA4177-1](#) Pin Function Descriptions

Pin No.	Mnemonic	Description
1, 5, 8	NIC	Not Internally Connected.
2	-IN	Inverting Input Channel.
3	+IN	Noninverting Input Channel.
4	V-	Negative Supply Voltage.
6	OUT	Output Channel.
7	V+	Positive Supply Voltage.



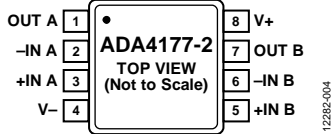

Figure 5. 8-Lead MSOP Pin Configuration, ADA4177-2

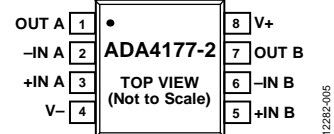

Figure 6. 8-Lead SOIC Pin Configuration, ADA4177-2

Table 7. ADA4177-2 Pin Function Descriptions

Pin No.	Mnemonic	Description
1	OUT A	Output Channel A.
2	-IN A	Inverting Input Channel A.
3	+IN A	Noninverting Input Channel A.
4	V-	Negative Supply Voltage.
5	+IN B	Noninverting Input Channel B.
6	-IN B	Inverting Input Channel B.
7	OUT B	Output Channel B.
8	V+	Positive Supply Voltage.

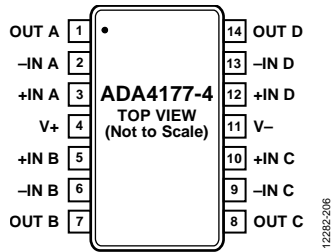

Figure 7. 14-Lead TSSOP Pin Configuration, ADA4177-4

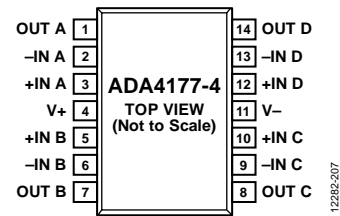

Figure 8. 14-Lead SOIC Pin Configuration, ADA4177-4

**Table 8. ADA4177-4 Pin Function Descriptions**

Pin No.	Mnemonic	Description
1	OUT A	Output Channel A.
2	-IN A	Inverting Input Channel A.
3	+IN A	Noninverting Input Channel A.
4	V+	Positive Supply Voltage.
5	+IN B	Noninverting Input Channel B.
6	-IN B	Inverting Input Channel B.
7	OUT B	Output Channel B.
8	OUT C	Output Channel C.
9	-IN C	Inverting Input Channel C.
10	+IN C	Noninverting Input Channel C.
11	V-	Negative Supply Voltage.
12	+IN D	Noninverting Input Channel D.
13	-IN D	Inverting Input Channel D.
14	OUT D	Output Channel D.

# TYPICAL PERFORMANCE CHARACTERISTICS

Ambient temperature ( $T_A$ ) = 25°C unless otherwise noted.

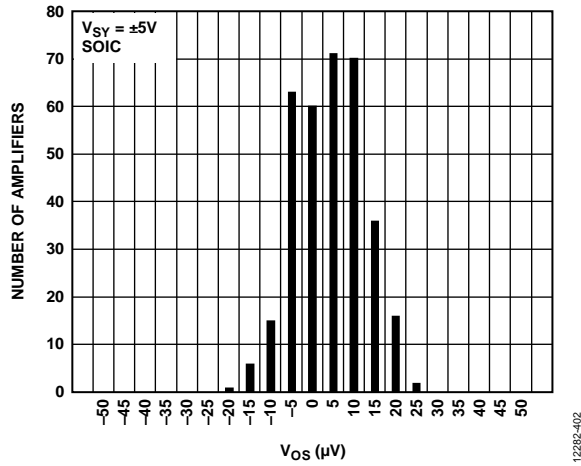

Figure 9. Input Offset Voltage ( $V_{OS}$ ) Distribution,  $V_{SY} = \pm 5V$ , 8-Lead SOIC

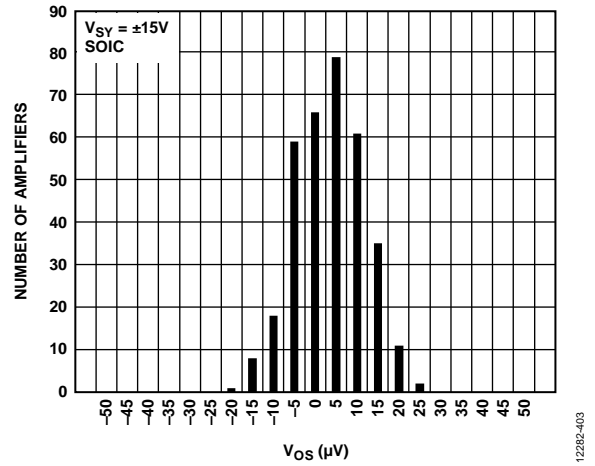

Figure 12. Input Offset Voltage ( $V_{OS}$ ) Distribution,  $V_{SY} = \pm 15V$ , 8-Lead SOIC

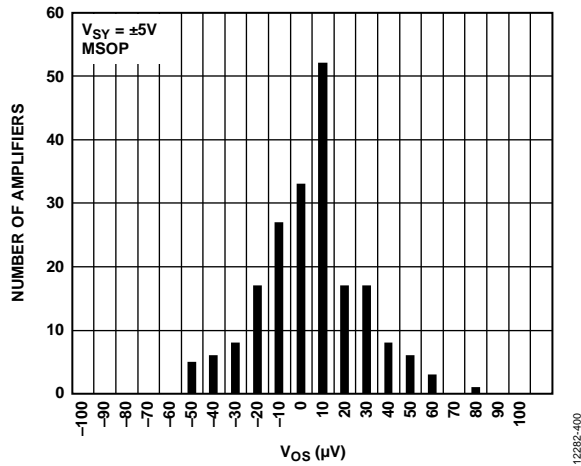

Figure 10. Input Offset Voltage ( $V_{OS}$ ) Distribution,  $V_{SY} = \pm 5V$ , 8-Lead MSOP

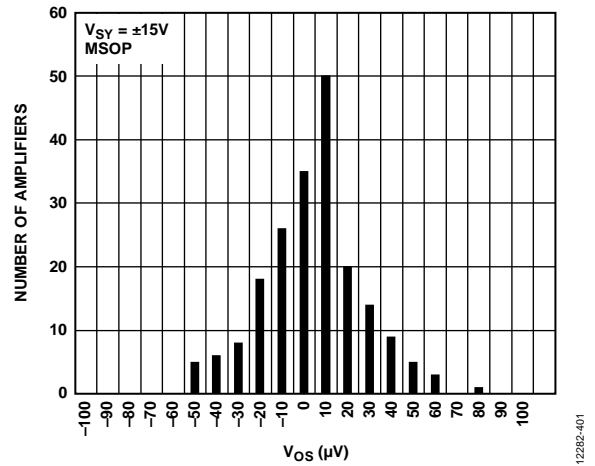

Figure 13. Input Offset Voltage ( $V_{OS}$ ) Distribution,  $V_{SY} = \pm 15V$ , 8-Lead MSOP

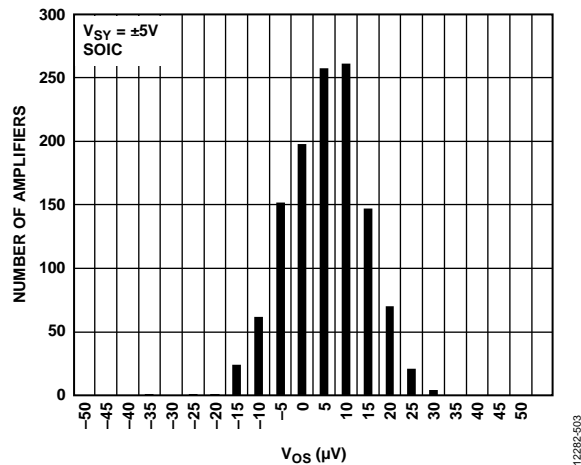

Figure 11. Input Offset Voltage ( $V_{OS}$ ) Distribution,  $V_{SY} = \pm 5V$ , 14-Lead SOIC

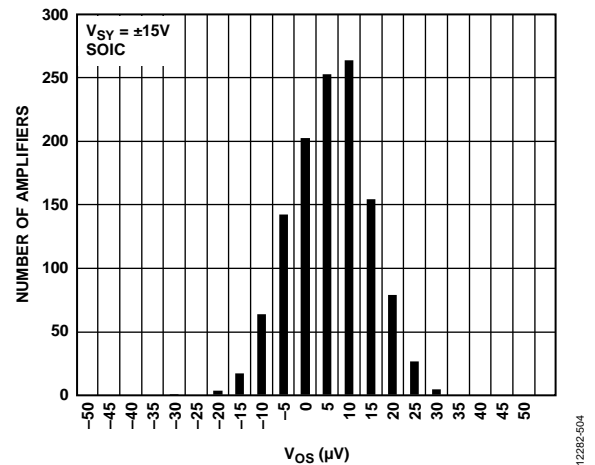
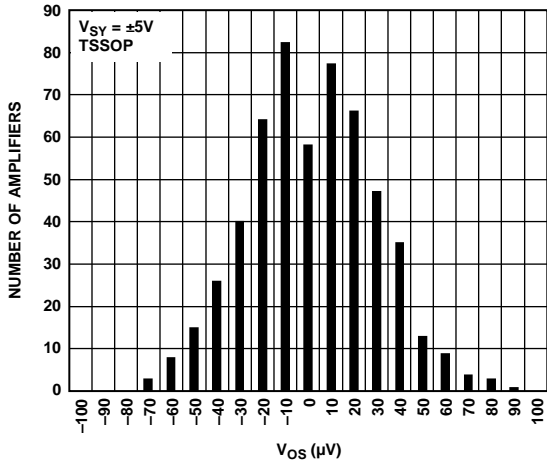
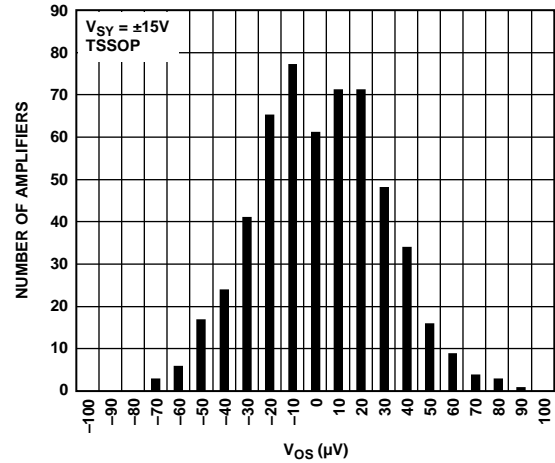

Figure 14. Input Offset Voltage ( $V_{OS}$ ) Distribution,  $V_{SY} = \pm 15V$ , 14-Lead SOIC



12282-501

Figure 15. Input Offset Voltage ( $V_{OS}$ ) Distribution,  $V_{SY} = \pm 5$  V, 14-Lead TSSOP



12282-502

Figure 18. Input Offset Voltage ( $V_{OS}$ ) Distribution,  $V_{SY} = \pm 15$  V, 14-Lead TSSOP

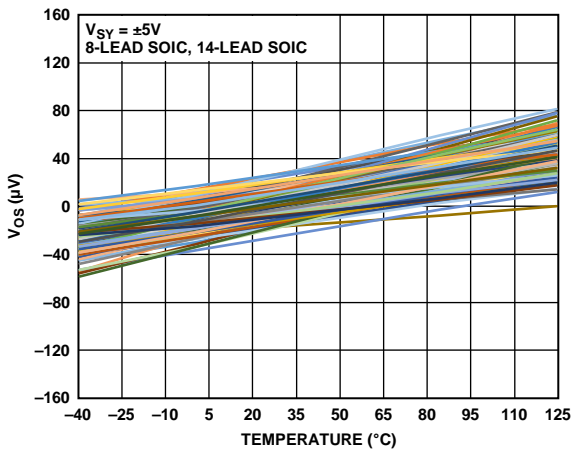

12282-508

Figure 16. Input Offset Voltage ( $V_{OS}$ ) vs. Temperature,  $V_{SY} = \pm 5$  V, 8-Lead SOIC and 14-Lead SOIC

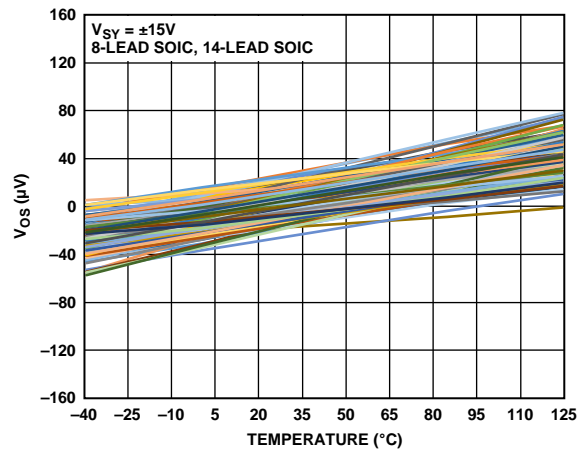

12282-511

Figure 19. Input Offset Voltage ( $V_{OS}$ ) vs. Temperature,  $V_{SY} = \pm 15$  V, 8-Lead SOIC and 14-Lead SOIC

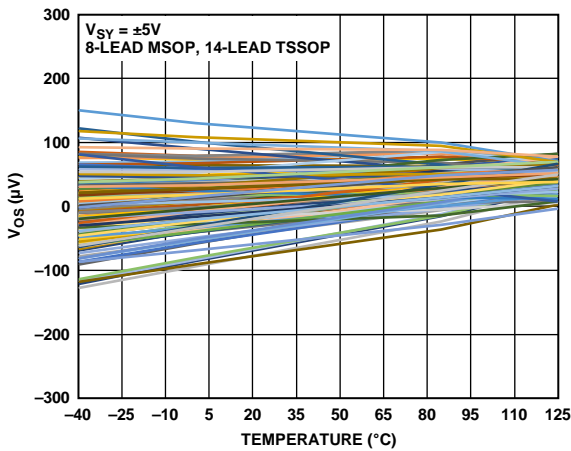

12282-512

Figure 17. Input Offset Voltage ( $V_{OS}$ ) vs. Temperature,  $V_{SY} = \pm 5$  V, 8-Lead MSOP and 14-Lead TSSOP

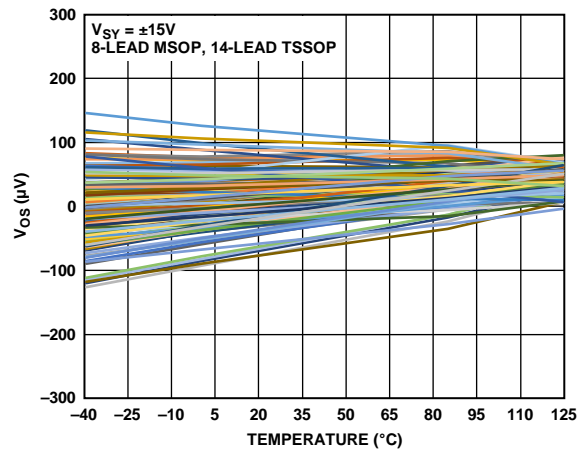

12282-515

Figure 20. Input Offset Voltage ( $V_{OS}$ ) vs. Temperature,  $V_{SY} = \pm 15$  V, 8-Lead MSOP and 14-Lead TSSOP

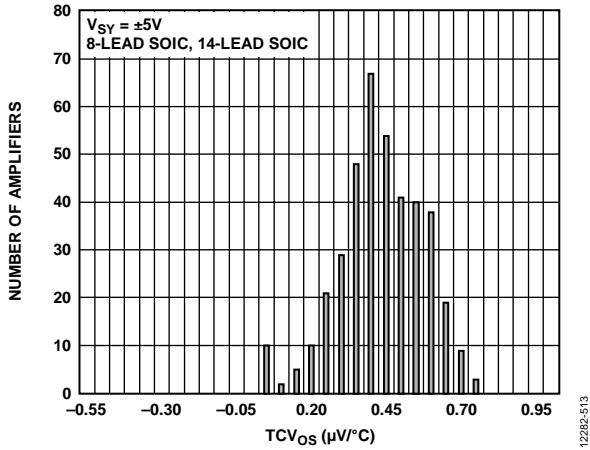

Figure 21. Temperature Coefficient of Offset Voltage ( $TCV_{OS}$ ),  $V_{SY} = \pm 5V$ , 8-Lead SOIC and 14-Lead SOIC

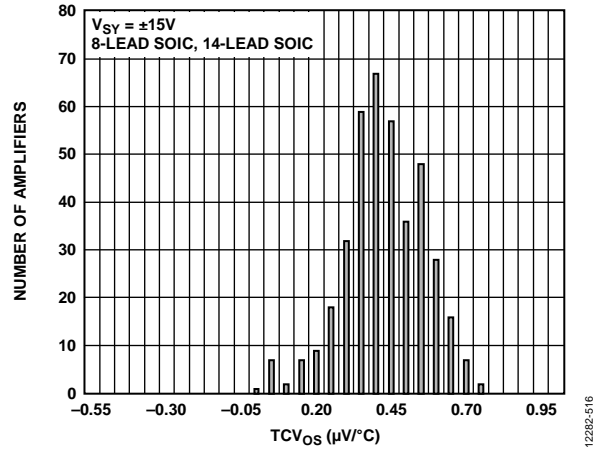

Figure 24. Temperature Coefficient of Offset Voltage ( $TCV_{OS}$ ),  $V_{SY} = \pm 15V$ , 8-Lead SOIC and 14-Lead SOIC

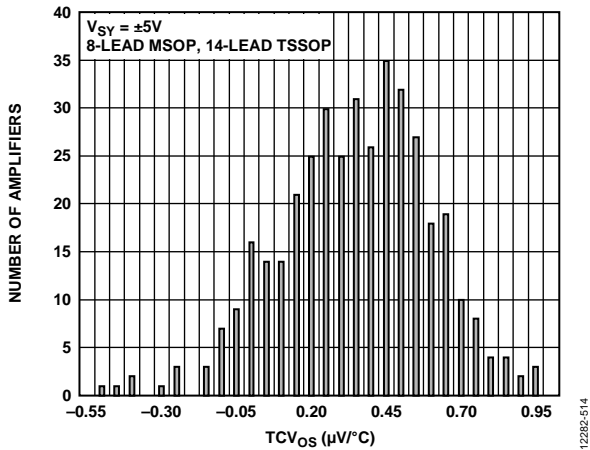

Figure 22. Temperature Coefficient of Offset Voltage ( $TCV_{OS}$ ),  $V_{SY} = \pm 5V$ , 8-Lead MSOP and 14-Lead TSSOP

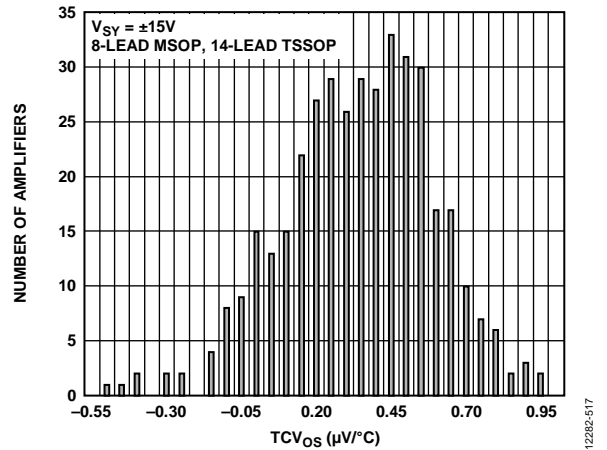

Figure 25. Temperature Coefficient of Offset Voltage ( $TCV_{OS}$ ),  $V_{SY} = \pm 15V$ , 8-Lead MSOP and 14-Lead TSSOP

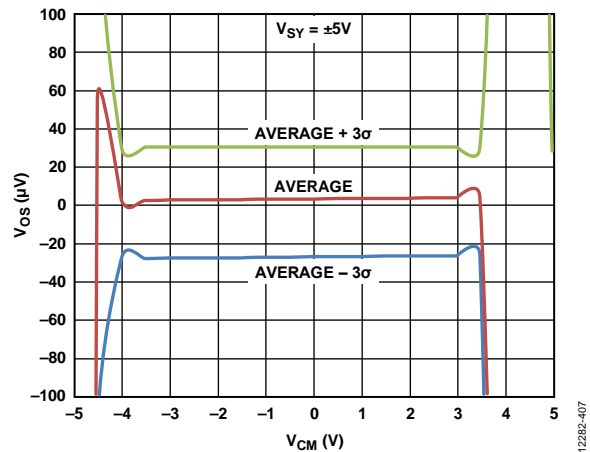

Figure 23. Input Offset Voltage ( $V_{OS}$ ) vs. Common-Mode Voltage ( $V_{CM}$ ),  $V_{SY} = \pm 5V$

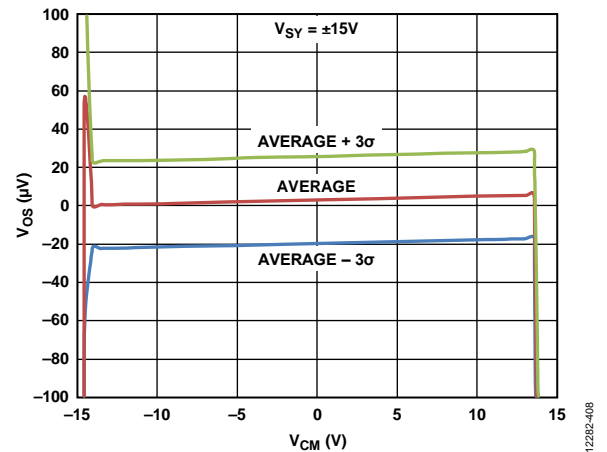

Figure 26. Input Offset Voltage ( $V_{OS}$ ) vs. Common-Mode Voltage ( $V_{CM}$ ),  $V_{S} = \pm 15V$

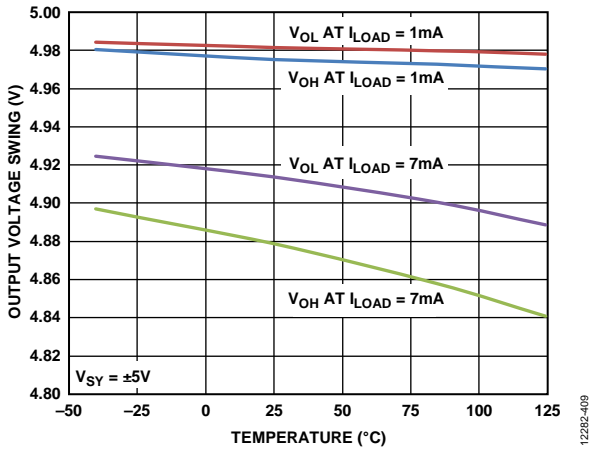

Figure 27. Output Voltage Swing vs. Temperature,  $V_{SY} = \pm 5V$

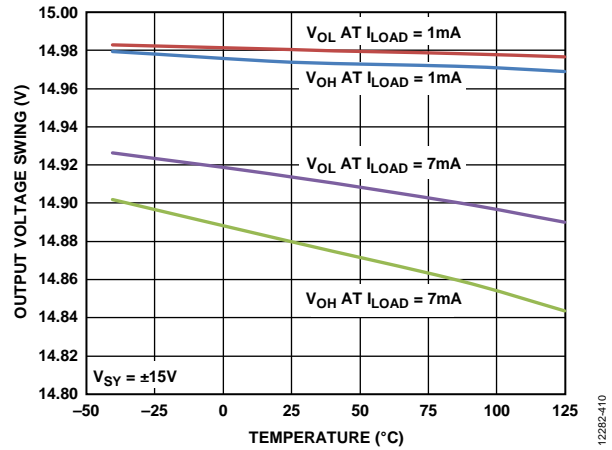

Figure 30. Output Voltage Swing vs. Temperature,  $V_{SY} = \pm 15V$

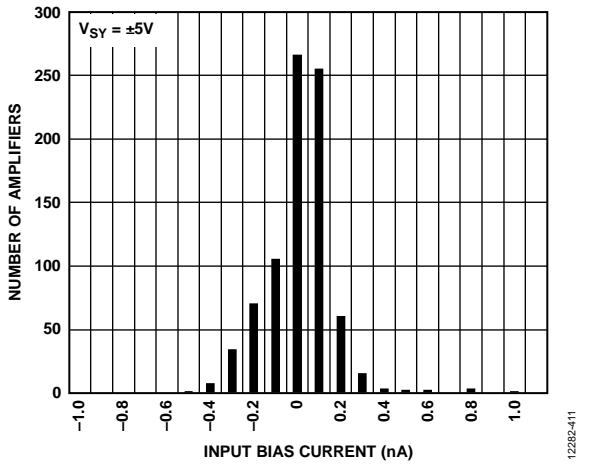

Figure 28. Input Bias Current Distribution,  $V_{SY} = \pm 5V$

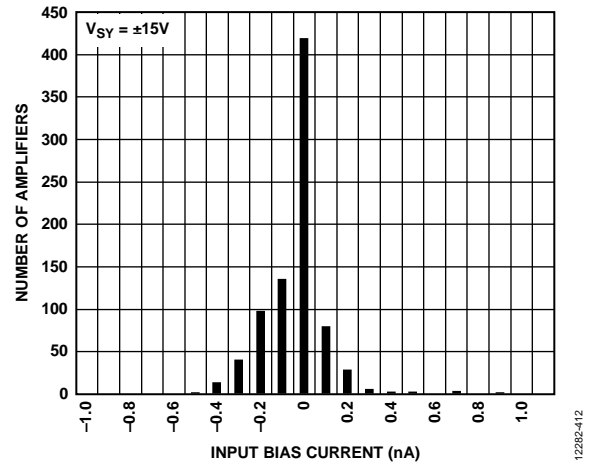

Figure 31. Input Bias Current Distribution,  $V_{SY} = \pm 15V$

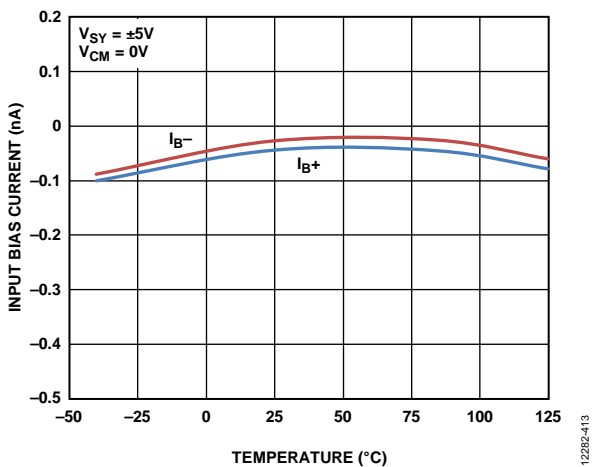

Figure 29. Input Bias Current ( $I_B$ ) vs. Temperature,  $V_{SY} = \pm 5V$

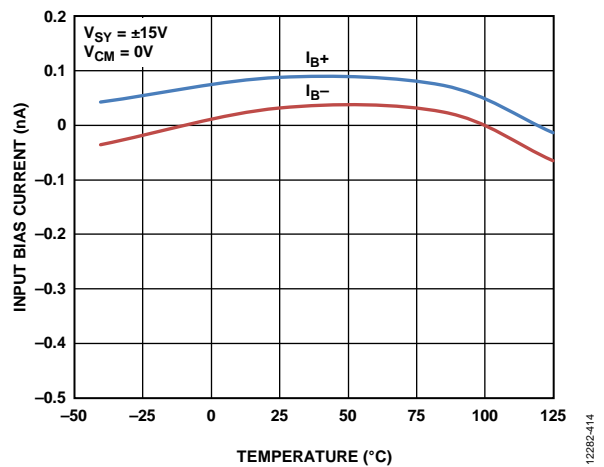

Figure 32. Input Bias Current ( $I_B$ ) vs. Temperature,  $V_{SY} = \pm 15V$

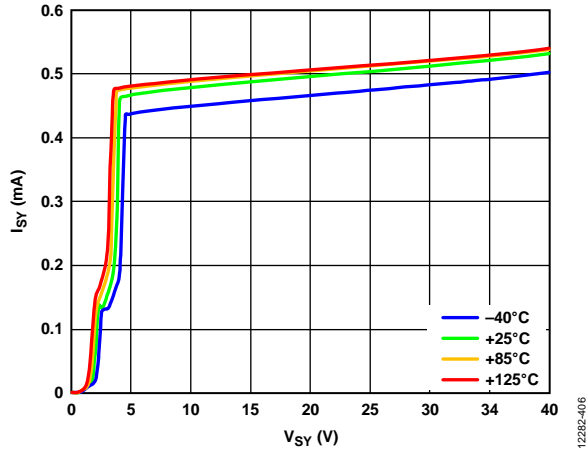

Figure 33. Supply Current per Amplifier ( $I_{SY}$ ) vs. Power Supply Voltage ( $V_{SY}$ )

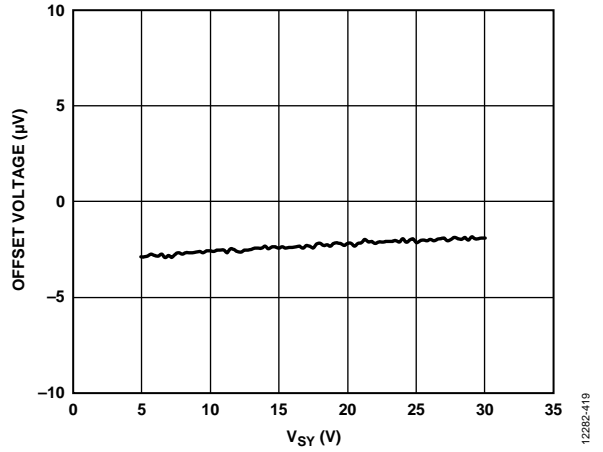

Figure 36. Offset Voltage ( $V_{OS}$ ) vs. Power Supply Voltage ( $V_{SY}$ )

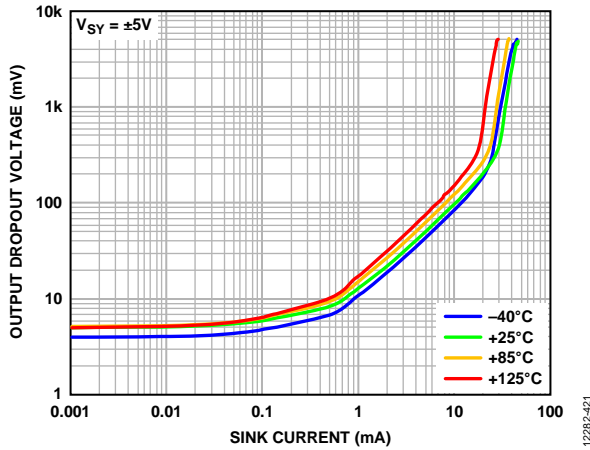

Figure 34. Output Dropout Voltage vs. Sink Current,  $V_{SY} = \pm 5V$

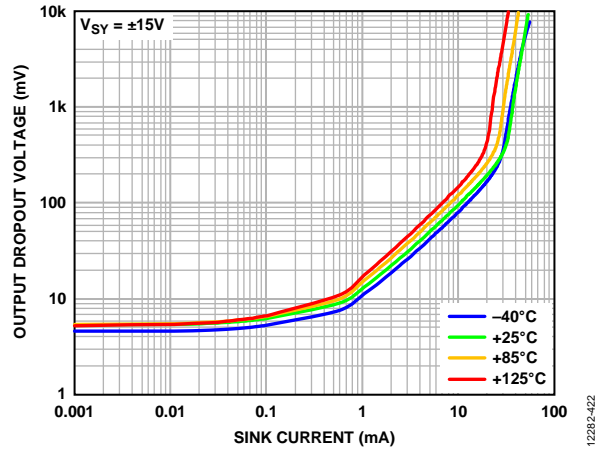

Figure 37. Output Dropout Voltage vs. Sink Current,  $V_{SY} = \pm 15V$

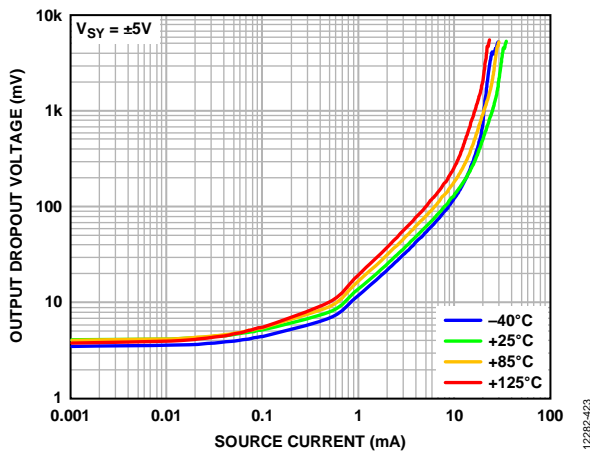

Figure 35. Output Dropout Voltage vs. Source Current,  $V_{SY} = \pm 5V$

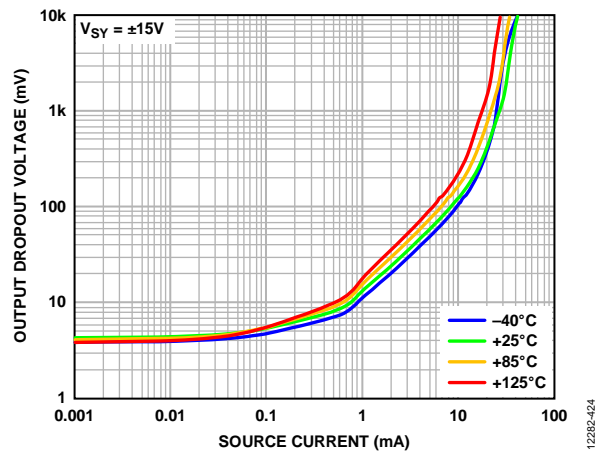

Figure 38. Output Dropout Voltage vs. Source Current,  $V_{SY} = \pm 15V$

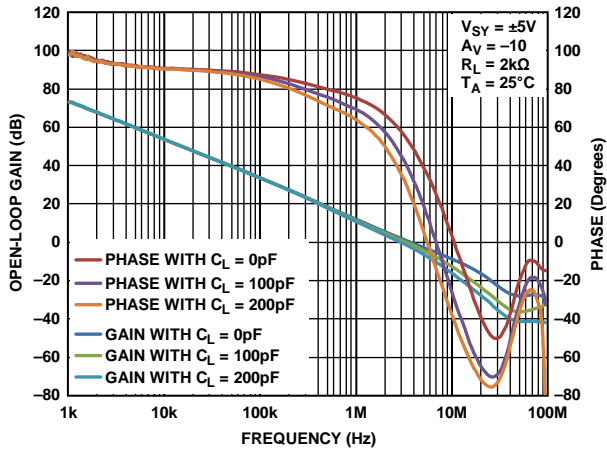

Figure 39. Open-Loop Gain and Phase vs. Frequency,  $V_{SY} = \pm 5 V$

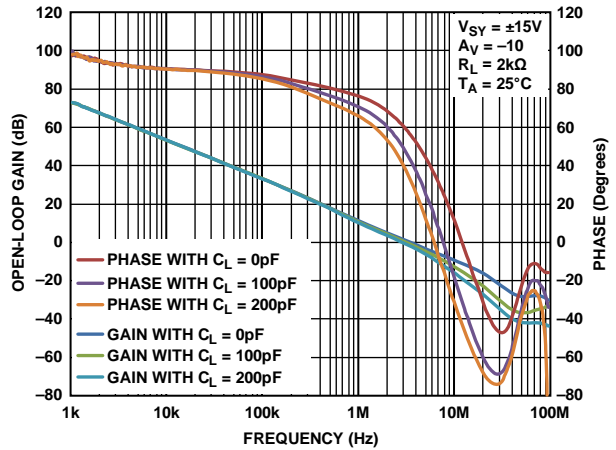

Figure 42. Open-Loop Gain and Phase vs. Frequency,  $V_{SY} = \pm 15 V$

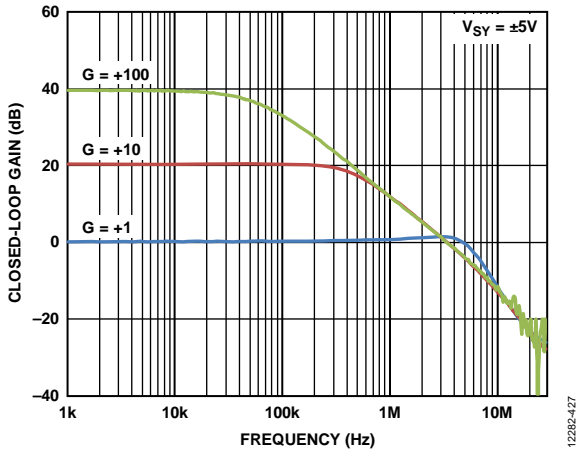

Figure 40. Closed-Loop Gain vs. Frequency,  $V_{SY} = \pm 5 V$

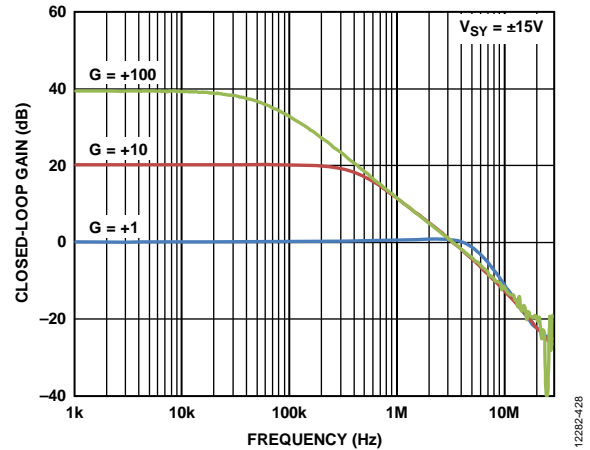

Figure 43. Closed-Loop Gain vs. Frequency,  $V_{SY} = \pm 15 V$

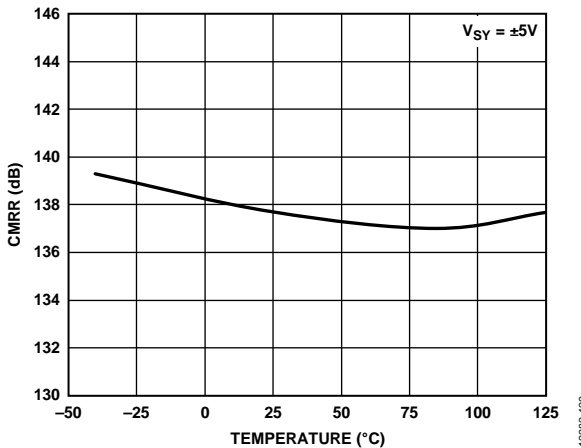

Figure 41. Common-Mode Rejection Ratio (CMRR) vs. Temperature,  $V_{SY} = \pm 5 V$

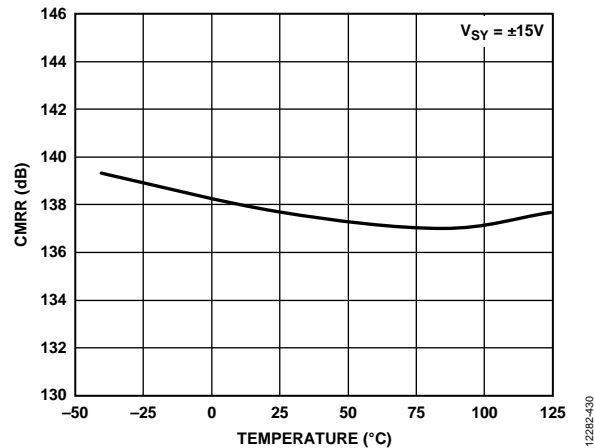

Figure 44. Common-Mode Rejection Ratio (CMRR) vs. Temperature,  $V_{SY} = \pm 15 V$



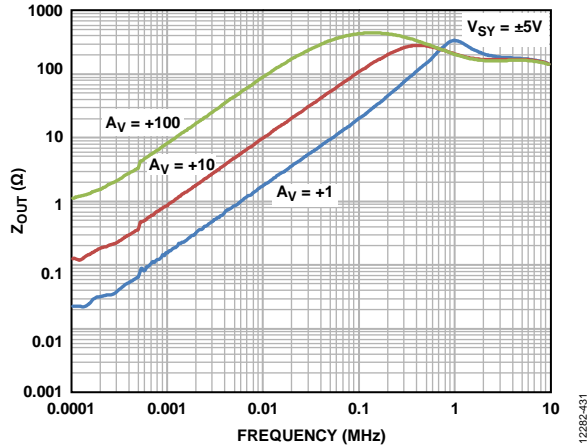

Figure 45. Output Impedance ( $Z_{OUT}$ ) vs. Frequency,  $V_{SY} = \pm 5V$

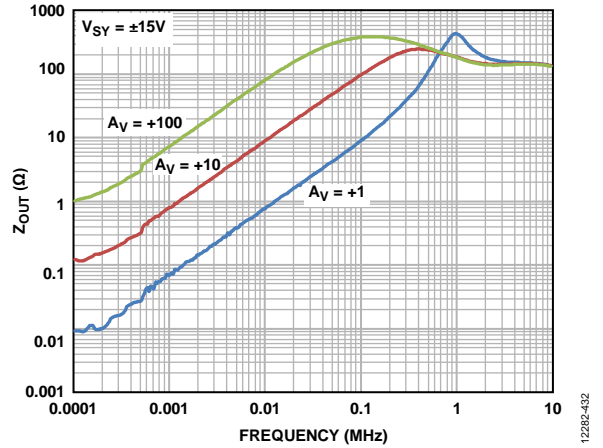

Figure 48. Output Impedance ( $Z_{OUT}$ ) vs. Frequency,  $V_{SY} = \pm 15V$

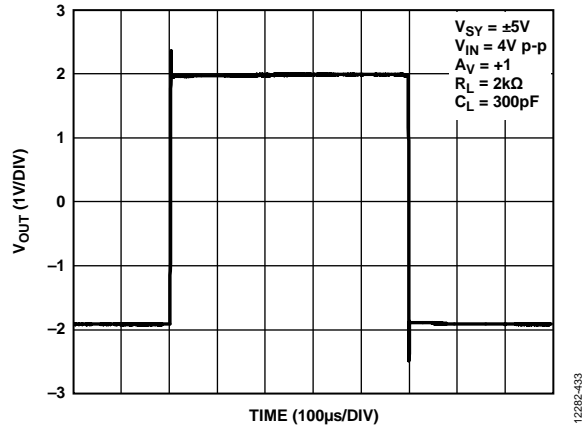

Figure 46. Large Signal Transient Response,  $V_{SY} = \pm 5V$

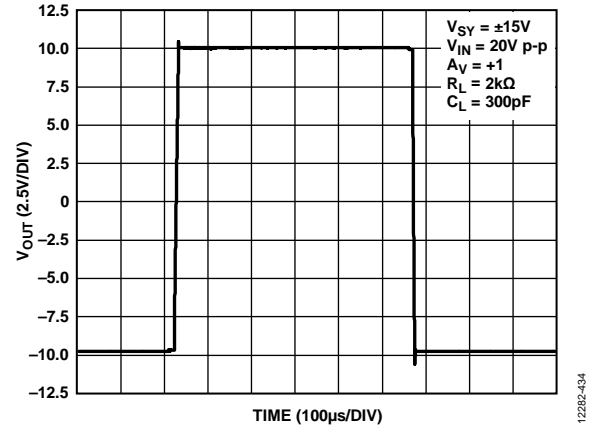

Figure 49. Large Signal Transient Response,  $V_{SY} = \pm 15V$

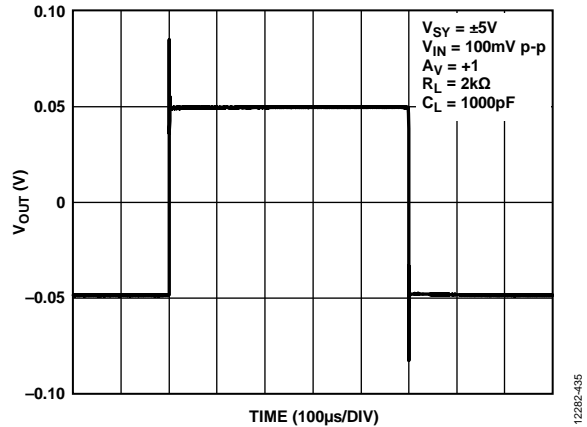

Figure 47. Small Signal Transient Response,  $V_{SY} = \pm 5V$

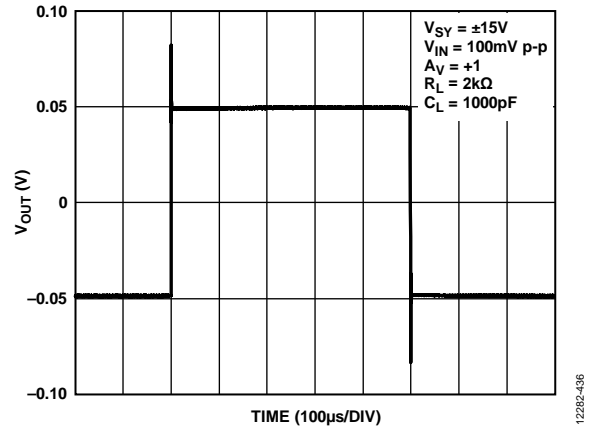

Figure 50. Small Signal Transient Response,  $V_{SY} = \pm 15V$

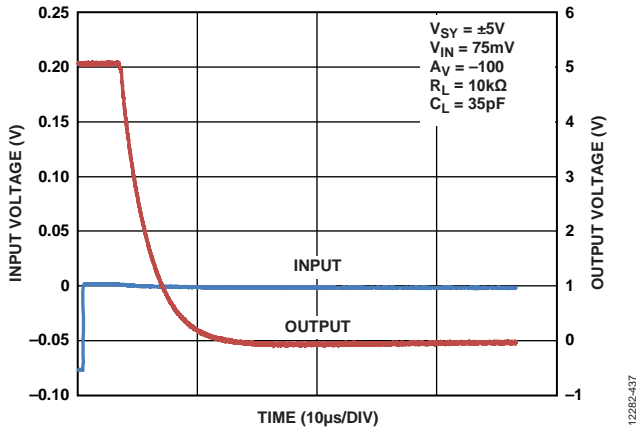

Figure 51. Positive Overload Recovery,  $V_{SY} = \pm 5 V$

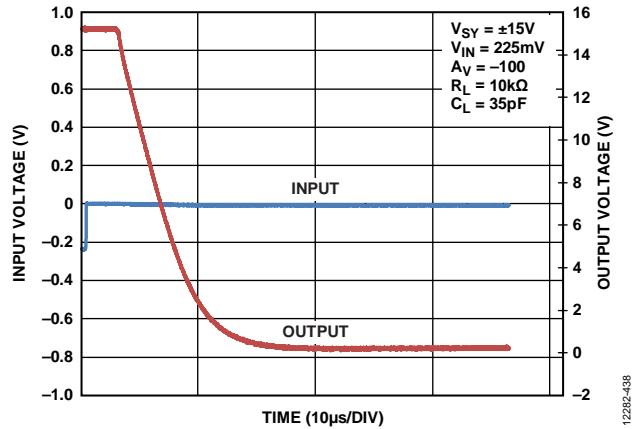

Figure 54. Positive Overload Recovery,  $V_{SY} = \pm 15 V$

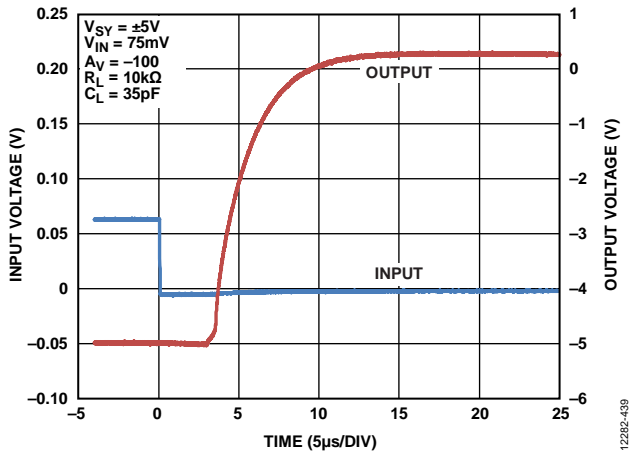

Figure 52. Negative Overload Recovery,  $V_{SY} = \pm 5 V$

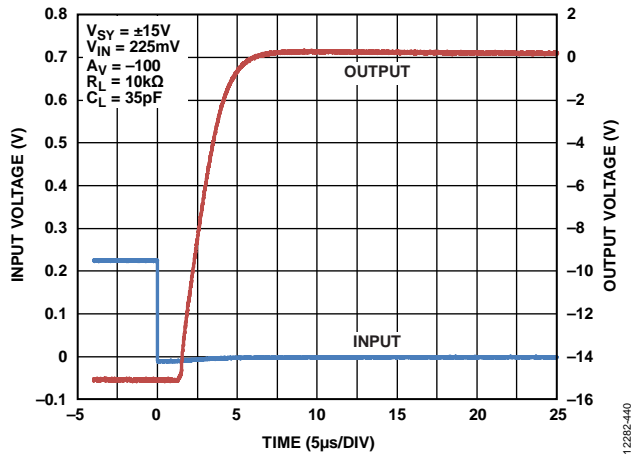

Figure 55. Negative Overload Recovery,  $V_{SY} = \pm 15 V$

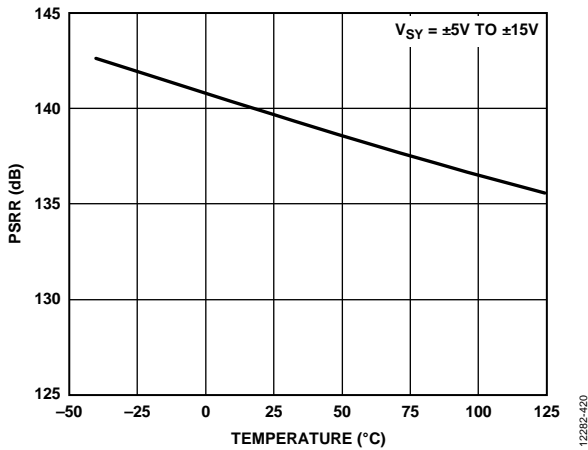

Figure 53. Power Supply Rejection Ratio (PSRR) vs. Temperature,  $V_{SY} = \pm 5 V$  to  $\pm 15 V$

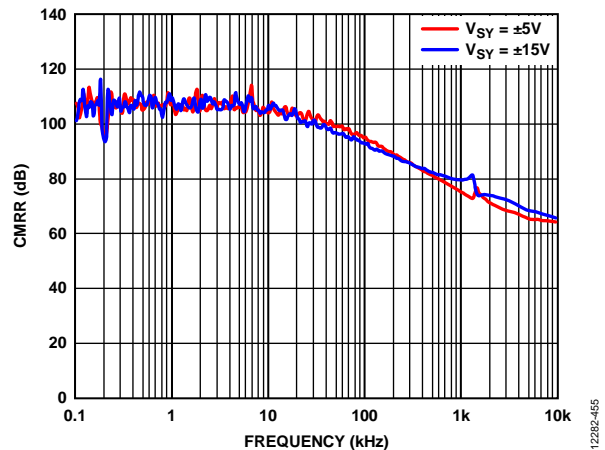

Figure 56. Common-Mode Rejection Ratio (CMRR) vs. Frequency,  $V_{SY} = \pm 5 V$  and  $V_{SY} = \pm 15 V$

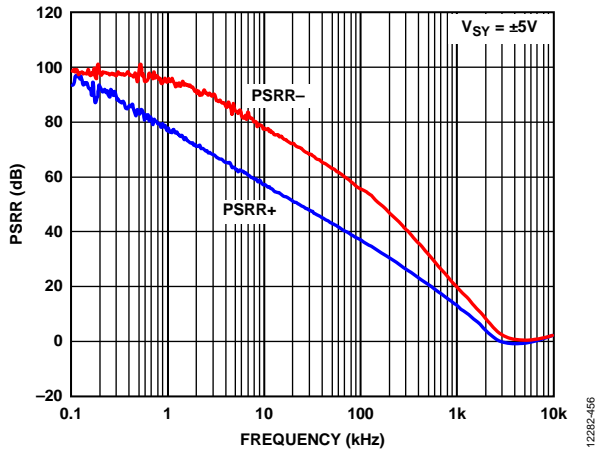

Figure 57. Power Supply Rejection Ratio (PSRR) vs. Frequency,  $V_{SY} = \pm 5V$

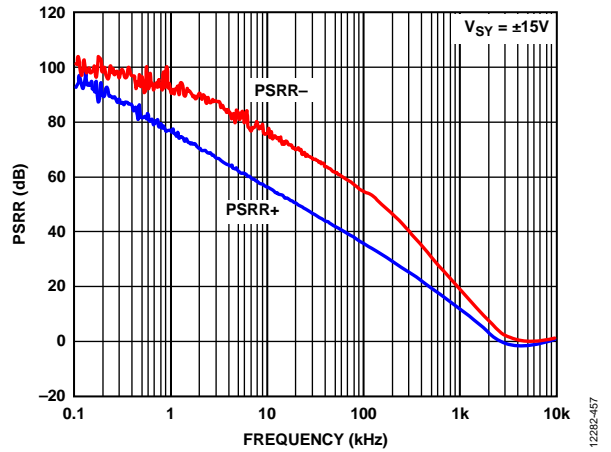

Figure 60. Power Supply Rejection Ratio (PSRR) vs. Frequency,  $V_{SY} = \pm 15V$

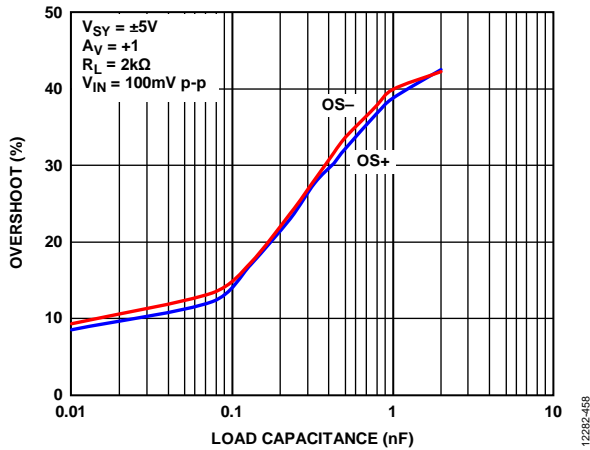

Figure 58. Small Signal Overshoot vs. Load Capacitance,  $V_{SY} = \pm 5V$

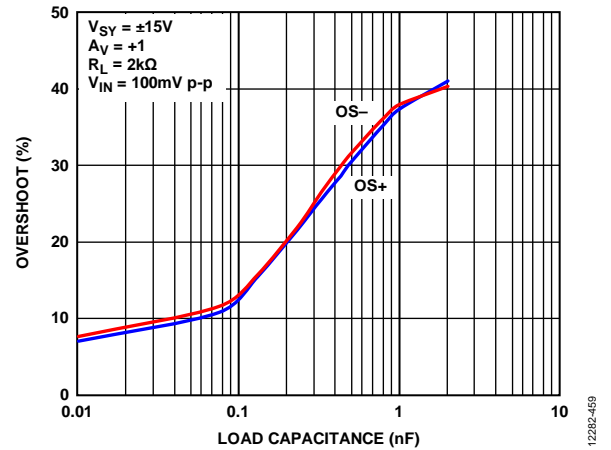

Figure 61. Small Signal Overshoot vs. Load Capacitance,  $V_{SY} = \pm 15V$

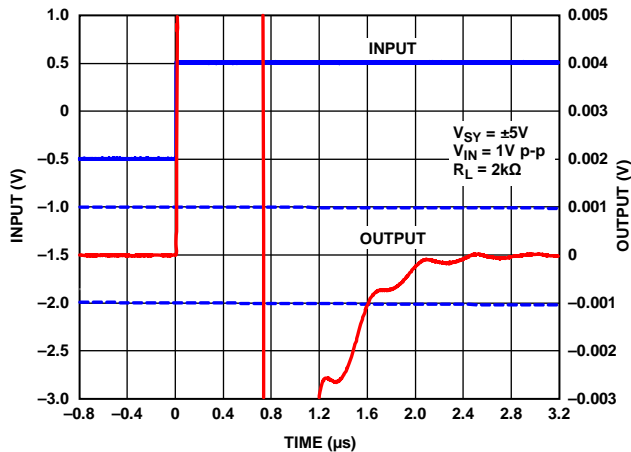

Figure 59. Positive Settling Time to 0.1%,  $V_{SY} = \pm 5V$

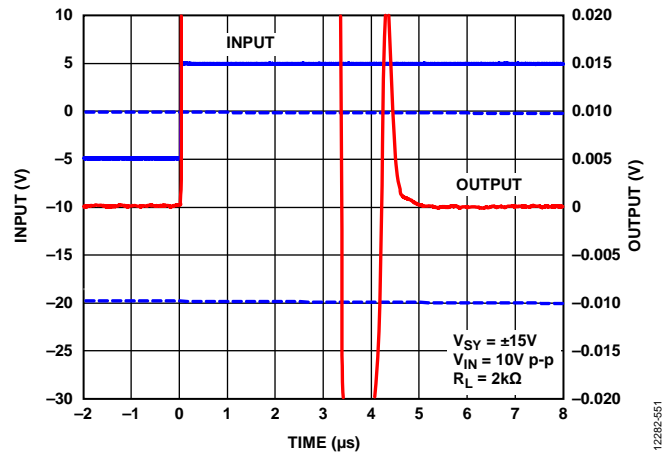

Figure 62. Positive Settling Time to 0.1%,  $V_{SY} = \pm 15V$

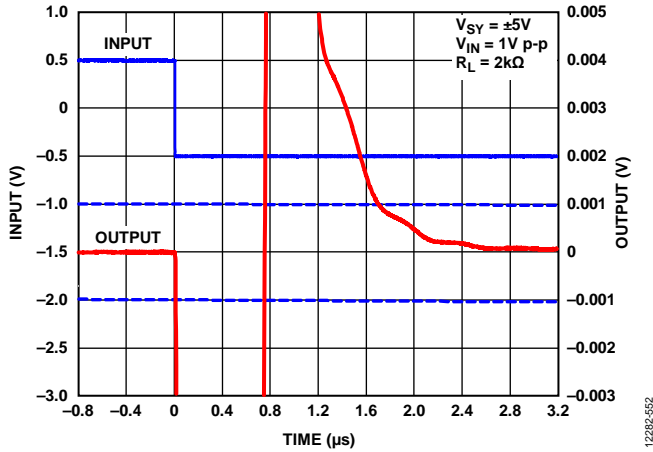

Figure 63. Negative Settling Time to 0.1%,  $V_{SY} = \pm 5V$

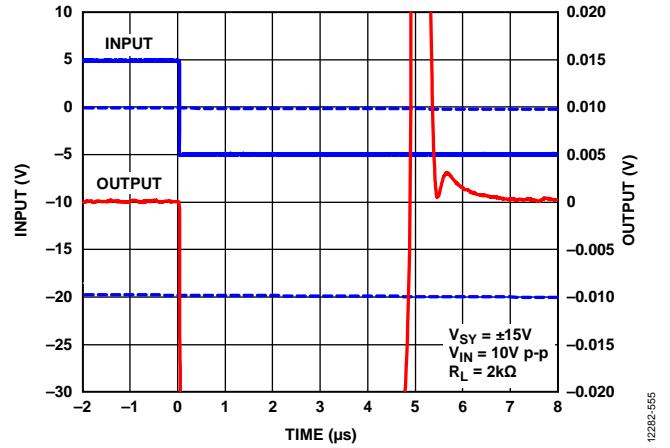

Figure 66. Negative Settling Time 0.1%,  $V_{SY} = \pm 15V$

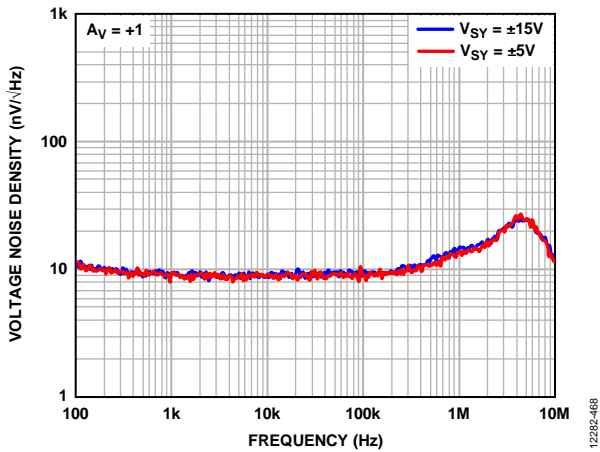

Figure 64. Voltage Noise Density vs. Frequency,  $V_{SY} = \pm 5V$  and  $V_{SY} = \pm 15V$

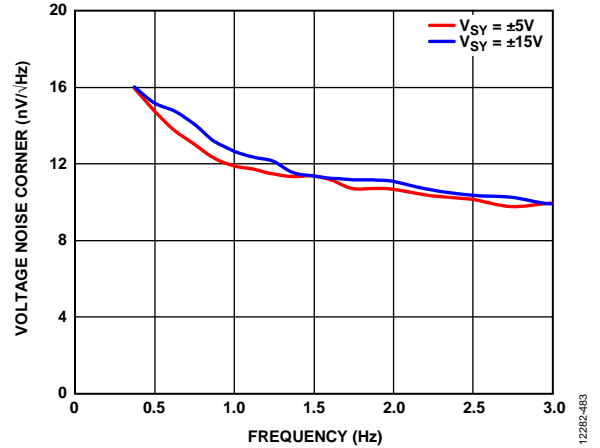

Figure 67. Voltage Noise Corner vs. Frequency,  $V_{SY} = \pm 5V$  and  $V_{SY} = \pm 15V$

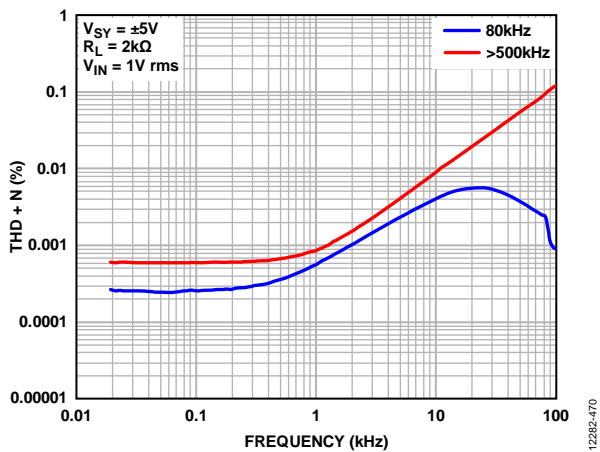

Figure 65. THD + N vs. Frequency,  $V_{SY} = \pm 5V$

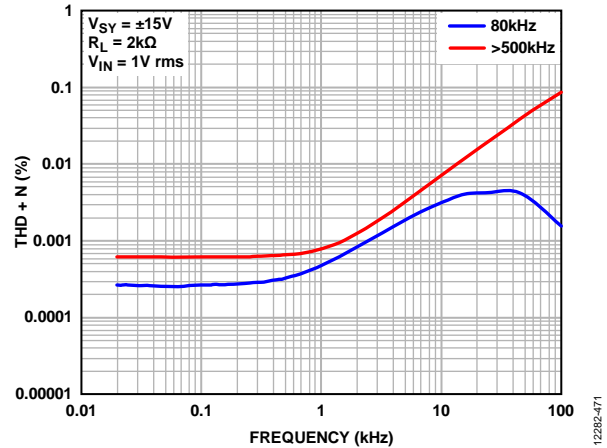

Figure 68. THD + N vs. Frequency,  $V_{SY} = \pm 15V$

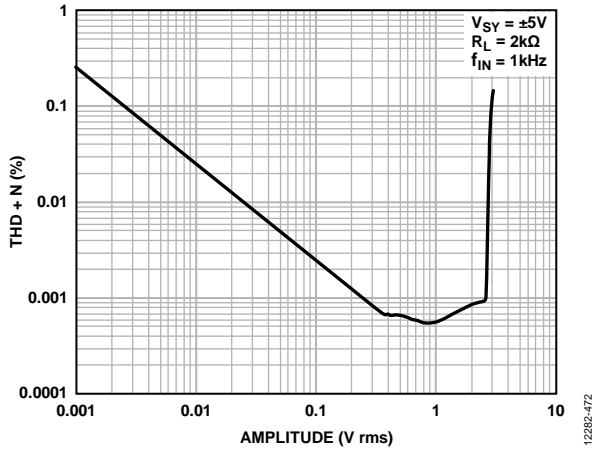

Figure 69. THD + N vs. Amplitude,  $V_{SY} = \pm 5 V$

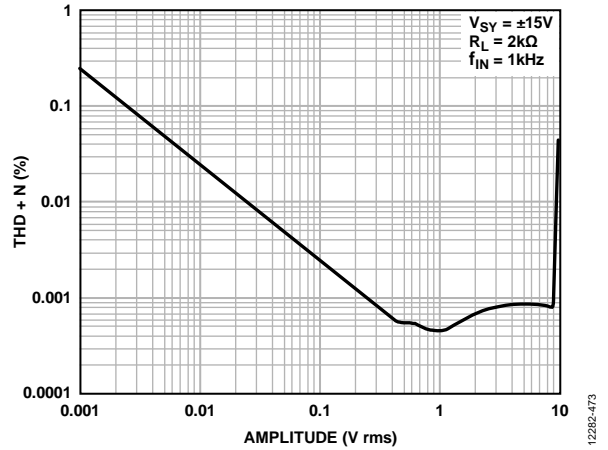

Figure 72. THD + N vs. Amplitude,  $V_{SY} = \pm 15 V$

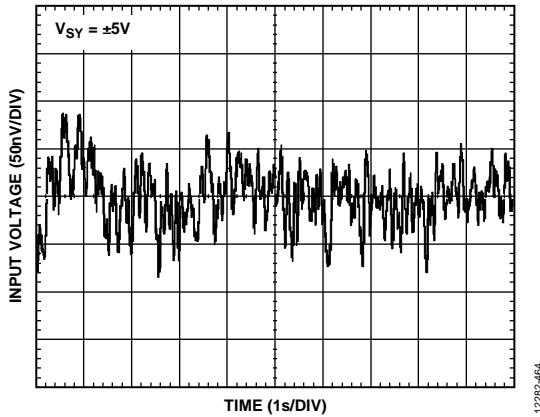

Figure 70. 0.1 Hz to 10 Hz Noise,  $V_{SY} = \pm 5 V$

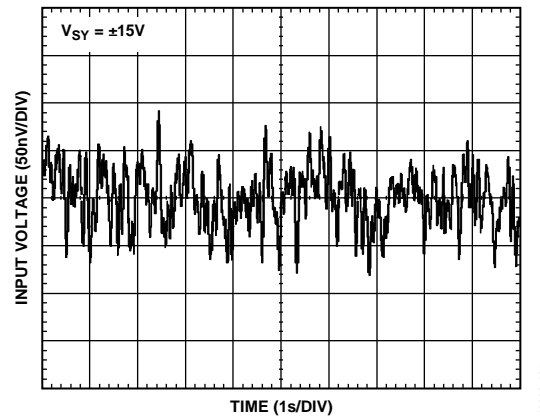

Figure 73. 0.1 Hz to 10 Hz Noise,  $V_{SY} = \pm 15 V$

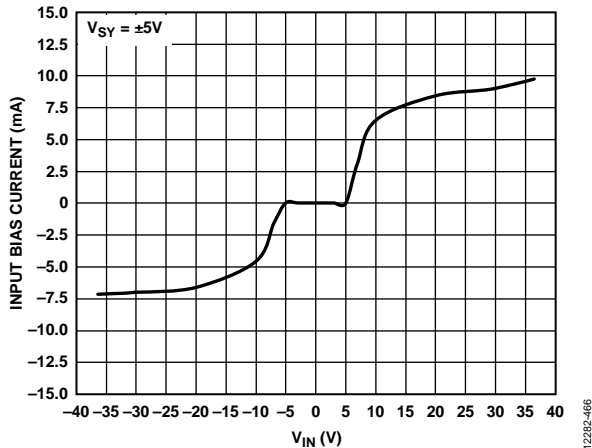

Figure 71. Input Bias Current vs. Input Voltage ( $V_{IN}$ ) Including Input Overvoltage Range (Beyond  $V_{SY} = \pm 5 V$ )

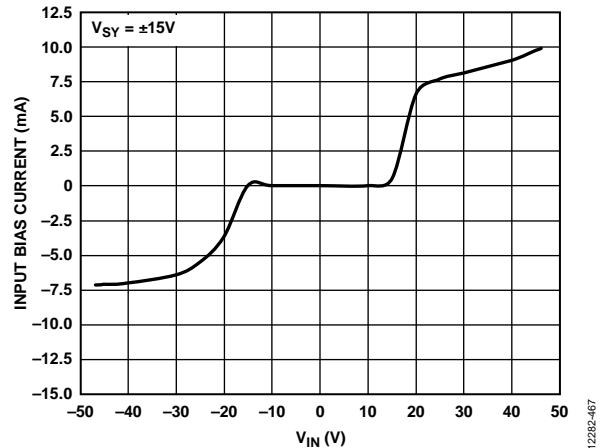

Figure 74. Input Bias Current vs. Input Voltage ( $V_{IN}$ ) Including Input Overvoltage Range (Beyond  $V_{SY} = \pm 15 V$ )

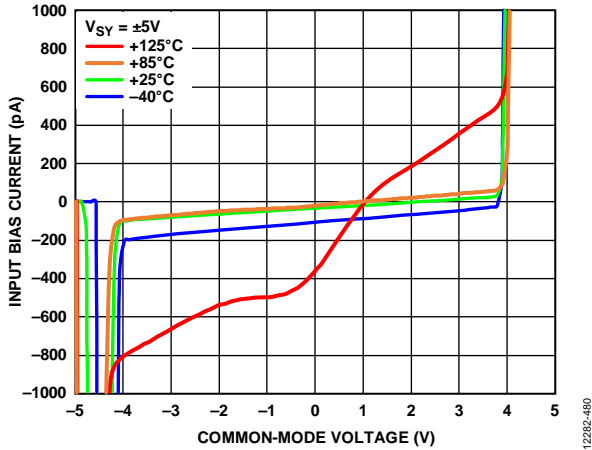

Figure 75. Input Bias Current vs. Common-Mode Voltage ( $V_{CM}$ ) and Temperature,  $V_{SY} = \pm 5 V$

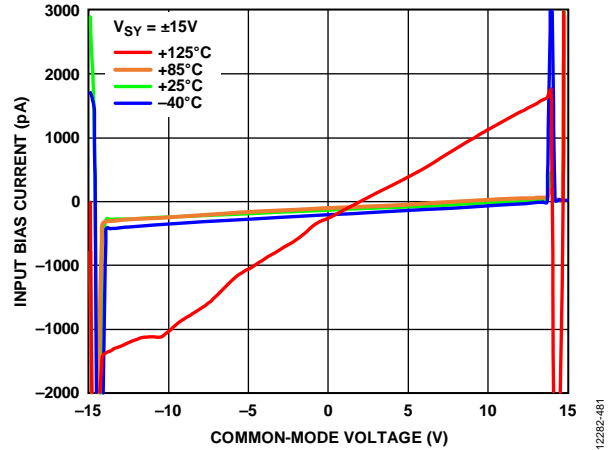

Figure 78. Input Bias Current vs. Common-Mode Voltage ( $V_{CM}$ ) and Temperature,  $V_{SY} = \pm 15 V$

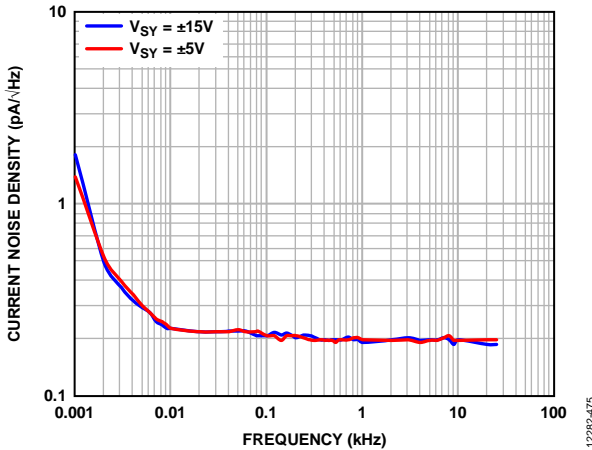

Figure 76. Current Noise Density vs. Frequency,  $V_{SY} = \pm 5 V$  and  $V_{SY} = \pm 15 V$

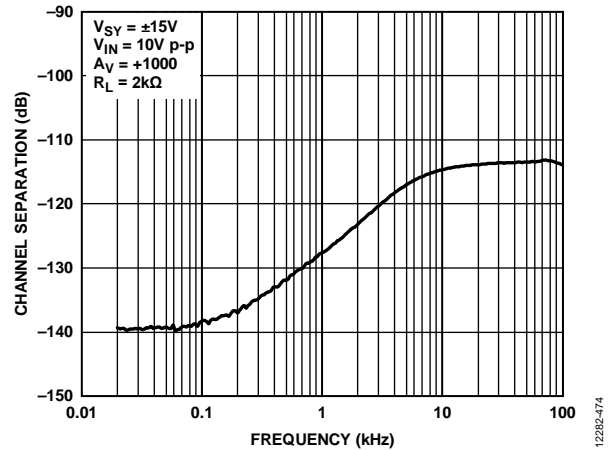

Figure 79. Channel Separation vs. Frequency,  $V_{SY} = \pm 15 V$

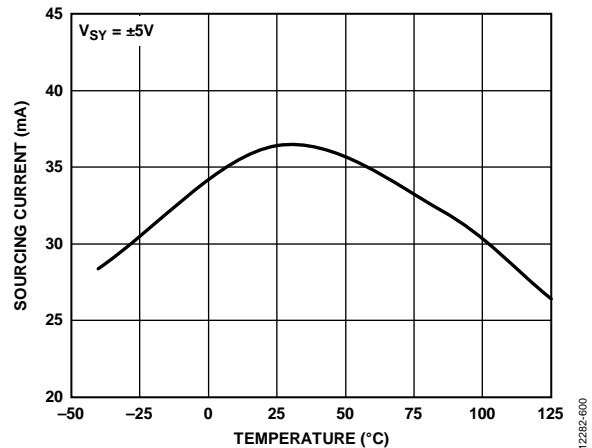

Figure 77. Output Short-Circuit Sourcing Current vs. Temperature,  $V_{SY} = \pm 5 V$

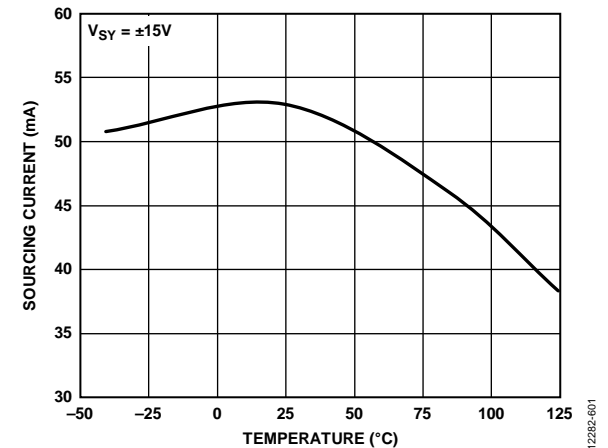

Figure 80. Output Short-Circuit Sourcing Current vs. Temperature,  $V_{SY} = \pm 15 V$

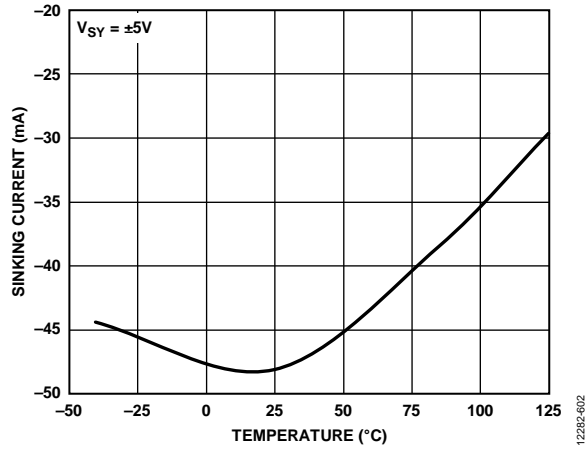

Figure 81. Output Short-Circuit Sinking Current vs. Temperature,  $V_{SY} = \pm 5V$

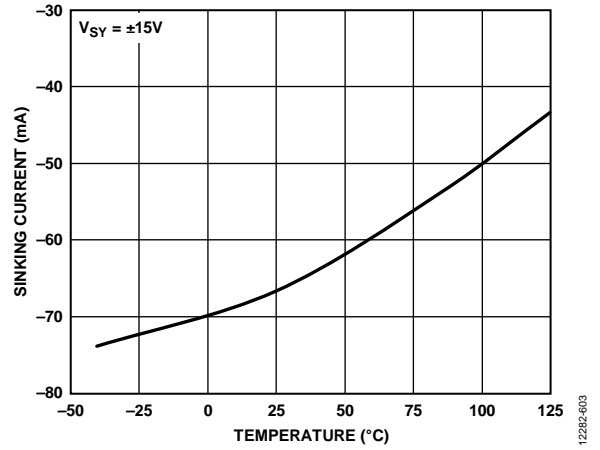

Figure 83. Output Short-Circuit Sinking Current vs. Temperature,  $V_{SY} = \pm 15V$

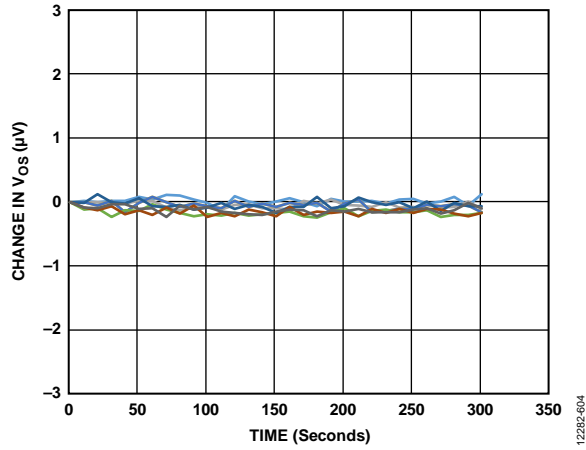

Figure 82. Offset Voltage Short-Term Drift

## THEORY OF OPERATION

The ADA4177-1, ADA4177-2, and ADA4177-4 are precision, bipolar op amps that integrate both input overvoltage protection (OVP) and input EMI filtering while maintaining a low 2 nA maximum bias current and a rail-to-rail output operation. Figure 84 shows a conceptual schematic of the main amplifier that uses super beta, bipolar input transistors and bias current cancellation to minimize the input bias current. The inputs are cascoded to protect the super beta input devices from damage during overvoltage conditions. The cascoded inputs feed into an active load that makes up the primary gain stage. A buffered transconductance ( $g_m$ ) stage converts a differential voltage to a differential current to drive the output stage. The rail-to-rail output can swing to 50 mV maximum (for example, the guaranteed room temperature limit for  $V_{OH}$  is 14.95 V when the positive supply is 15 V) with a 1 mA load at 25°C.

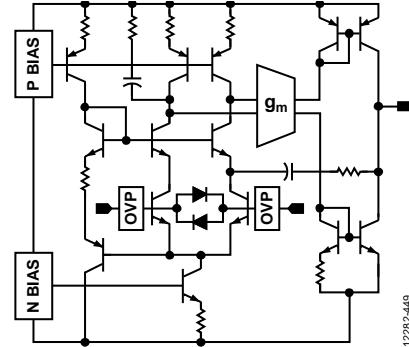

Figure 84. Conceptual Schematic



## APPLICATIONS INFORMATION

### ACTIVE OVERVOLTAGE PROTECTION

The ADA4177-1/ADA4177-2/ADA4177-4 use active overvoltage protection to protect the device from damage when the inputs are driven to a voltage up to 32 V above the positive supply voltage or 32 V below the negative supply voltage. The ADA4177-1/ADA4177-2/ADA4177-4 not only protect the input from damage, but they also reduce the input noise.

#### Common Protection Methods

##### Add an External Series Input Resistor

When an op amp does not have input overvoltage protection, moving the input voltage above or below the supply voltage can cause excessive input current, which can damage the op amp. To avoid this, add a series resistor at the input. To protect the op amp from a 30 V transient beyond either rail, limit the input current to 5 mA, and add a 6 kΩ series resistor to the input. However, a trade-off of adding the series resistor is that it adds thermal noise. The 6 kΩ series resistor exhibits 10 nV/√Hz of thermal noise, which adds quadrature thermal noise from the resistor with the op amp noise.

$$N_{TOTAL} = \sqrt{N_{OP\ AMP}^2 + N_{RESISTOR}^2}$$

where:

$N_{OP\ AMP}$  is the op amp noise.

$N_{RESISTOR}$  is the thermal noise generated by the resistor.

When the additional thermal noise from the series resistor is added to the thermal noise (8 nV/√Hz) of the ADA4177-1/ADA4177-2/ADA4177-4, the 6 kΩ series resistor brings the total thermal noise to 12 nV/√Hz, which is a 70% increase in thermal noise. Figure 85 shows how noise from the additional source resistance adds to the total noise at the amplifier input; the higher the source resistance, the higher the total noise. Because the ADA4177-1/ADA4177-2/ADA4177-4 have integrated input protection for overvoltage conditions, the noise trade-off is avoided.

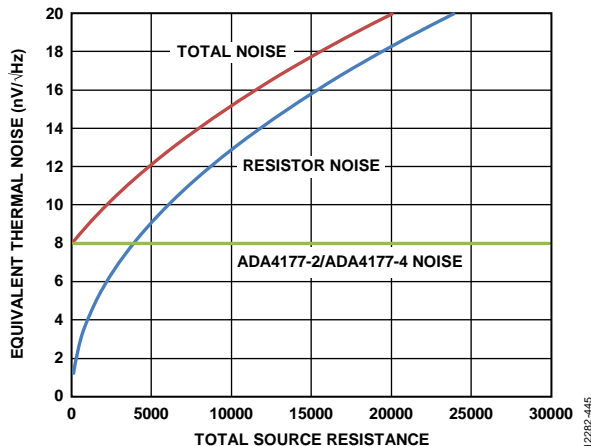

Figure 85. Equivalent Thermal Noise vs. Total Source Resistance

##### Add External Clamping Diodes

Precision op amps have a low offset voltage ( $V_{OS}$ ) and a high common-mode rejection ratio (CMRR). Both of these characteristics simplify system calibration and minimize dynamic error. To maintain these specifications in the presence of electrostatic discharge (ESD) events, bipolar op amps often have internal clamp diodes and small limiting resistors in series with their inputs; however, these do not address fault conditions where the inputs exceed the rails. In these cases, the system designer commonly adds clamping diodes (D1 and D2) along with a series resistor ( $R_{OVP}$ ), as shown in Figure 86.

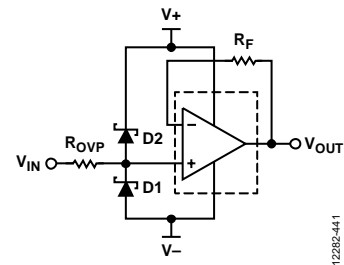

Figure 86. Common Scheme for Protecting Precision Amplifier Inputs from Overvoltage Conditions

If the signal source at  $V_{IN}$  is driven to one diode voltage beyond the op amp supplies, the fault current is limited by  $R_{OVP}$ . Schottky diodes have a low forward knee voltage of 200 mV less than a typical small signal diode. Therefore, all overvoltage currents are shunted through the external diodes (D1 and D2). The reverse leakage current for a typical Schottky diode is extremely variable with the reverse voltage level. Therefore, as the noninverting input of the op amp swings, the D1 and D2 leakage currents do not match, and the differences pass through  $R_{OVP}$ , creating a voltage drop. The voltage drop on  $R_{OVP}$  appears as a variation in  $V_{OS}$ , which can drastically reduce the CMRR performance. Because the ADA4177-1/ADA4177-2/ADA4177-4 have integrated input protection during overvoltage conditions, the degradation in performance is avoided.

##### Input Protection Circuit

The ADA4177-1/ADA4177-2/ADA4177-4 inputs provide overvoltage protection without the trade-offs encountered in the common design methods. The conceptual schematic of the input is shown in Figure 87.

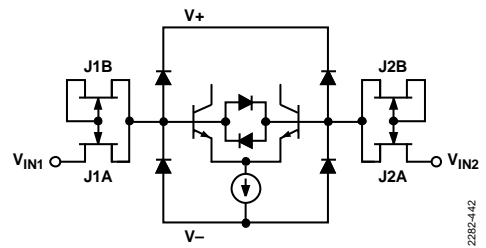

Figure 87. Conceptual Schematic of the Inputs of the ADA4177-1/ADA4177-2/ADA4177-4

J1A, J1B, J2A, and J2B are depletion mode junction field effect transistors (JFETs) that replace the series resistance in the conventional protection scheme. Under normal operation, the input bias current of the ADA4177-1/ADA4177-2/ADA4177-4 flows through the J1A and J2A transistors without pinching off the channel. To achieve excellent noise performance, J1A and J2A must have a low on resistance ( $R_{DSON}$ ) of approximately 300  $\Omega$ .

When either input exceeds the rail by more than a diode, large currents flow through either J1A or J2A, which causes the channels to pinch off and effectively raises their resistance. Figure 88 shows the positive overvoltage and negative overvoltage characteristics as the FET channel pinches.

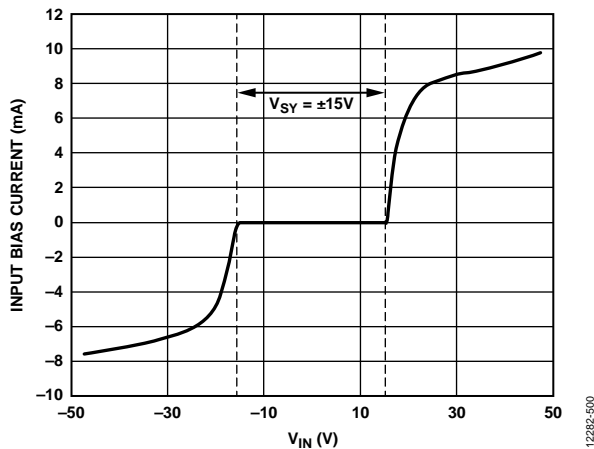

Figure 88. Input Bias Current During Positive and Negative Overvoltage,  $V_{SY} = \pm 15V$ , Voltage Follower Configuration

Figure 89 shows how the JFET effective resistance increases exponentially as shown by the measurements at 2 V, 20 V, and 40 V overvoltage. Note that as the overvoltage increases from 2 V to 40 V, the resistance increases from 300  $\Omega$  to 3.5 k $\Omega$  (a factor of 11).

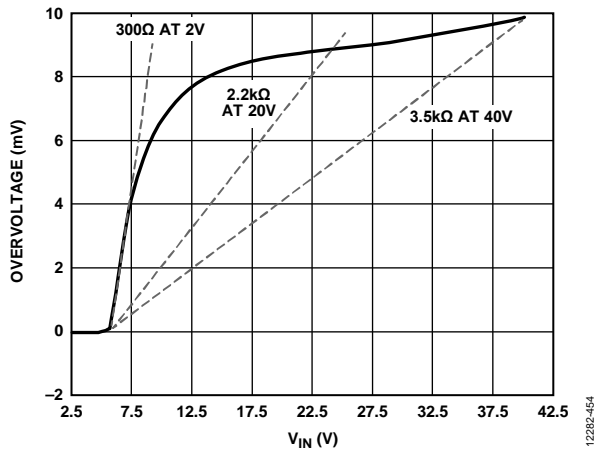

Figure 89. Overvoltage vs. Input Voltage ( $V_{IN}$ ), Voltage Follower Configuration

### LIMITING OVERVOLTAGE CURRENT OUT OF THE POSITIVE SUPPLY PIN

Because the positive power supply of the system may be incapable of sinking the large overvoltage current of 8 mA (see Figure 88), care was taken to divide down this current into the positive rail during an overvoltage event. As shown in Figure 90, Q1L is a lateral PNP transistor that serves two purposes. First, the emitter base acts as a clamping diode to route the overvoltage current away from the  $V+$  pin and to the  $V-$  pin. Second, it divides down this current via the beta of Q1L. At an emitter current of 8 mA, the beta of Q1L is approximately 8, which reduces the current injected into the positive supply by a factor of 8.

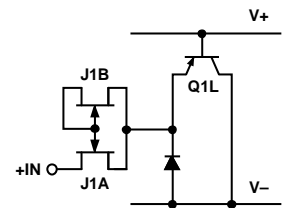

Figure 90. Overvoltage Protection Circuitry

Figure 91 shows the positive and negative supply currents when the input voltage exceeds the supply voltages (and overvoltage condition). The current at the  $V+$  terminal does not reverse direction during an overvoltage event because the current is directed to  $V-$  via the collector of Q1L.

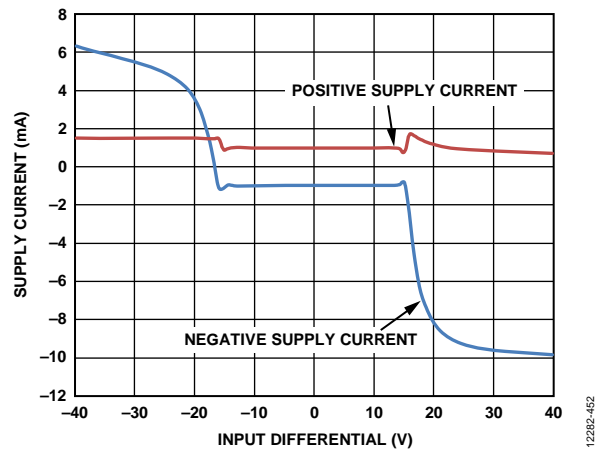

Figure 91. Supply Current vs. Input Differential, Circuit Configured at Unity Gain with  $V+ = +15V$  and  $V- = -15V$

If negative overvoltage transients are expected, ensure that the negative voltage source driving  $V-$  can handle sourcing current without forcing current into the device and causing the supply voltage to change.

**EMI PROTECTION**

The ADA4177-1/ADA4177-2/ADA4177-4 inputs are also protected from high frequency EMI. In an op amp with no EMI protection, signals not within the bandwidth of the op amp couple into sensitive amplifier inputs and become rectified as they travel through the amplifier, eventually appearing as ac feedthrough on top of a dc offset. When an input filter is not provided, these offsets can be quite large. These offsets are referred to as the electromagnetic interference rejection ratio (EMIRR). The amplifier EMIRR is defined as

$$EMIRR = 20 \times \log \left( \frac{100 \text{ mV}}{\Delta V_{OS}} \right)$$

where:

100 mV is generally the peak-to-peak input used for the test.  $\Delta V_{OS}$  is the change in the op amp offset as a result of the input signal.

Figure 92 shows the input EMI protection of the ADA4177-1/ADA4177-2/ADA4177-4.

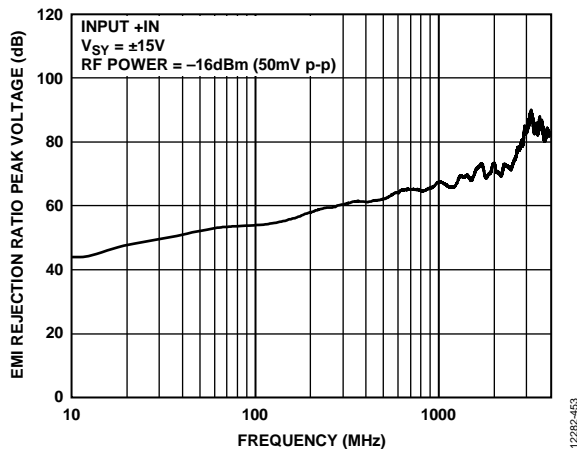

Figure 92. EMI Rejection Ratio Peak Voltage vs. Frequency

**SELF HEATING**

During an overvoltage condition, the ADA4177-1/ADA4177-2/ADA4177-4 dissipate heat according to the thermal resistance ( $\theta_{JA}$ ) of the package it is in, which, in turn, heats up the die. Ensure that the specified operating junction temperature does not exceed 150°C for device protection. Extended overtemperature exposure can cause some operating specifications to shift outside of their guaranteed limits.

As shown in Figure 88, the ADA4177-1/ADA4177-2/ADA4177-4 inputs sink by approximately 8 mA at 15 V overvoltage. In that condition, the ADA4177-1/ADA4177-2/ADA4177-4 dissipate 120 mW of power. If the package has a  $\theta_{JA}$  of 100°C/W, the junction temperature rises by approximately 12°C over the ambient temperature of the package and junction. In such a case, derate the ambient operating temperature by 12°C (125°C minus 12°C) for an absolute maximum operating temperature of 113°C. When the junction temperature exceeds the absolute maximum junction temperature of 125°C, add an additional series

resistance to the inputs to further decrease the overvoltage current. Figure 93 shows the maximum operating temperature vs. the continuous overvoltage at  $\theta_{JA} = 150^\circ\text{C/W}$ .

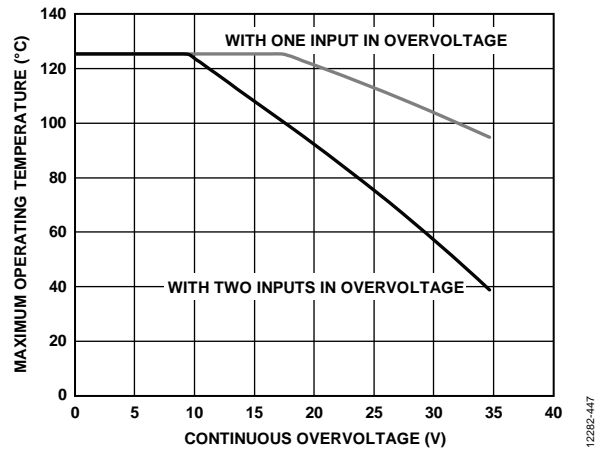

Figure 93. Maximum Operating Temperature vs. Continuous Overvoltage for One Input and Two Inputs ( $\theta_{JA} = 150^\circ\text{C/W}$ )

**USING THE ADA4177-1/ADA4177-2/ADA4177-4 AS A COMPARATOR**

The ADA4177-1, ADA4177-2, and ADA4177-4 can be used as a comparator as long as relatively small input impedance can be tolerated. That is, the input differential pair is diode clamped but the overvoltage protection circuitry limits the differential. Figure 94 shows the input current vs. the input differential voltage with  $\pm 15$  V supplies.

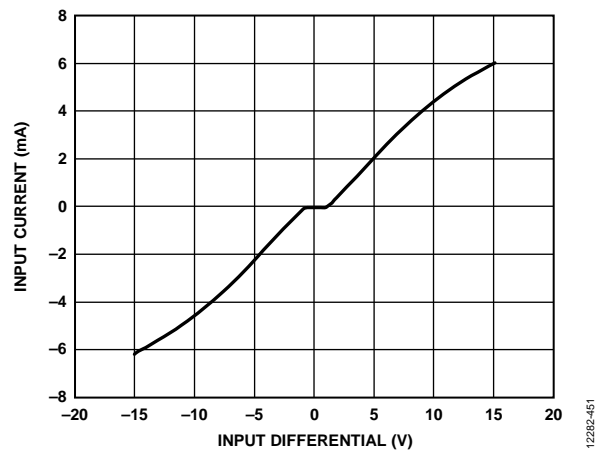

Figure 94. Input Current vs. Input Differential with  $\pm 15$  V Supplies

Figure 95 shows the input and output of a comparator circuit referenced to ground using the ADA4177-1, ADA4177-2, or ADA4177-4. The supply voltages are  $\pm 5$  V. The  $-INx$  input is grounded and a positive input is stepped to  $\pm 1$  V. Both the positive and negative recovery is approximately 4  $\mu\text{s}$ .

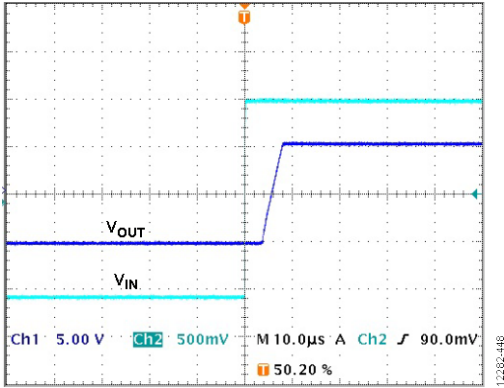

Figure 95. ADA4177-1/ADA4177-2/ADA4177-4 Used as a Comparator with  $\pm 5$  V Supplies and a  $\pm 1$  V Input Step, Voltage Follower Configuration

**OUTPUT PHASE REVERSAL**

Phase reversal is defined as a change in polarity in the amplifier transfer function. Many op amps exhibit phase reversal when the voltage applied to the input is greater than the maximum common-mode voltage. In some instances, this phase reversal can cause permanent damage to the amplifier. In feedback loops, it can result in system lockups or equipment damage. The ADA4177-1, ADA4177-2, and ADA4177-4 are immune to phase reversal problems even at input voltages beyond the power supply settings.

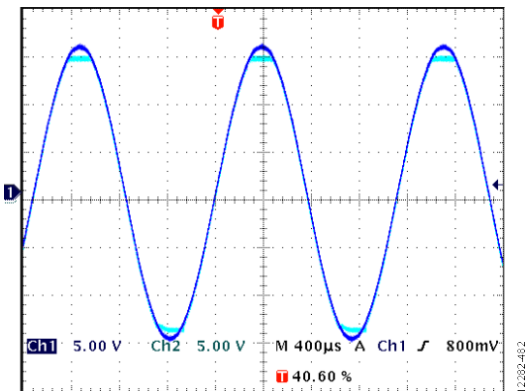

Figure 96. Output Showing No Phase Reversal in Overvoltage Condition

**PROPER PRINTED CIRCUIT BOARD (PCB) LAYOUT**

The ADA4177-1, ADA4177-2, and ADA4177-4 are high precision devices. To ensure optimum performance at the PCB level, take care in the design of the board layout.

To avoid leakage currents, maintain a clean and moisture free board surface. Coating the surface creates a barrier to moisture accumulation and reduces parasitic resistance on the board.

Keeping supply traces short and properly bypassing the power supplies minimizes the power supply disturbances caused by the output current variation, such as when driving an ac signal into a heavy load. Connect bypass capacitors as closely as possible to the device supply pins. Stray capacitances are a concern at the outputs and the inputs of the amplifier. Keep the signal traces at least 5 mm from supply lines to minimize coupling.

A variation in temperature across the PCB can cause a mismatch in the Seebeck voltages at solder joints and other points where dissimilar metals are in contact, resulting in thermal voltage errors. To minimize these thermocouple effects, orient resistors so that heat sources warm both ends equally. Ensure, where possible, that input signal paths contain matching numbers and types of components, to match the number and type of thermocouple junctions. For example, dummy components such as zero value resistors can be used to match real resistors in the opposite input path. Place matching components in close proximity to each other, and orient them in the same manner. Ensure that leads are of equal length so that thermal conduction is in equilibrium. Keep heat sources on the PCB as far away from amplifier input circuitry as is practical.

The use of a ground plane is highly recommended. A ground plane reduces EMI noise and maintains a constant temperature across the circuit board.

OUTLINE DIMENSIONS

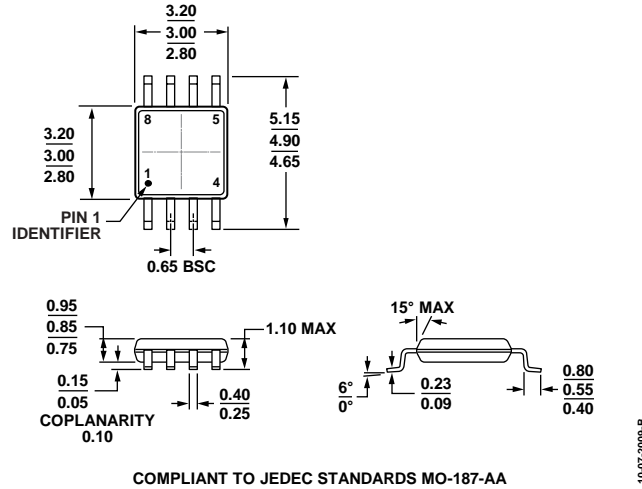

Figure 97. 8-Lead Mini Small Outline Package [MSOP] (RM-8)  
Dimensions shown in millimeters

10-07-2009-B

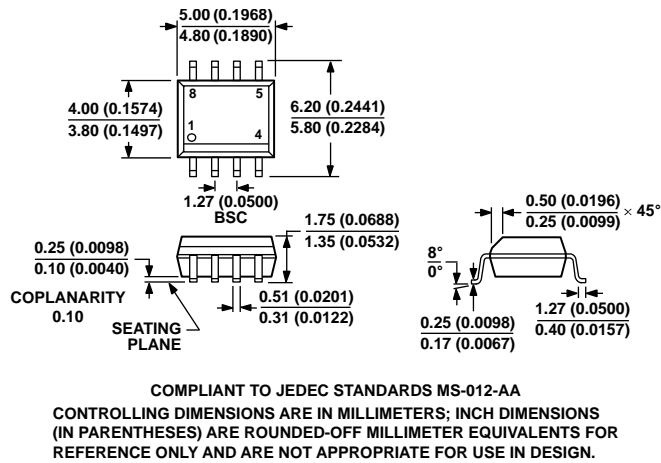
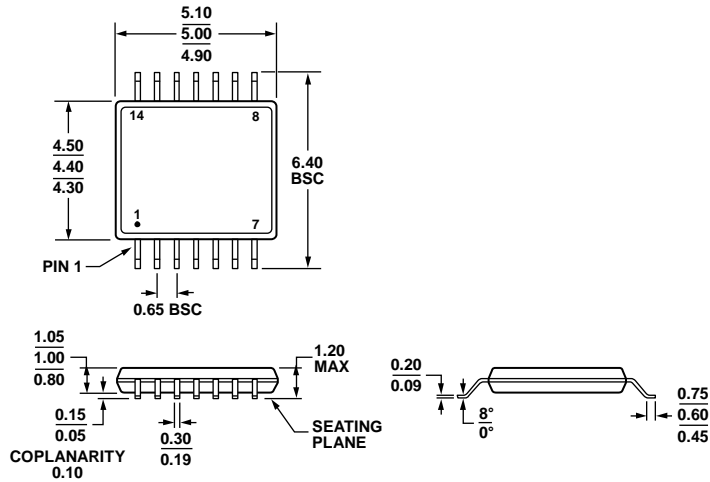

Figure 98. 8-Lead Standard Small Outline Package [SOIC\_N] Narrow Body (R-8)  
Dimensions shown in millimeters and (inches)

012407-A



COMPLIANT TO JEDEC STANDARDS MO-153-AB-1

Figure 99. 14-Lead Thin Shrink Small Outline Package [TSSOP] (RU-14)

Dimensions shown in millimeters

061908-A

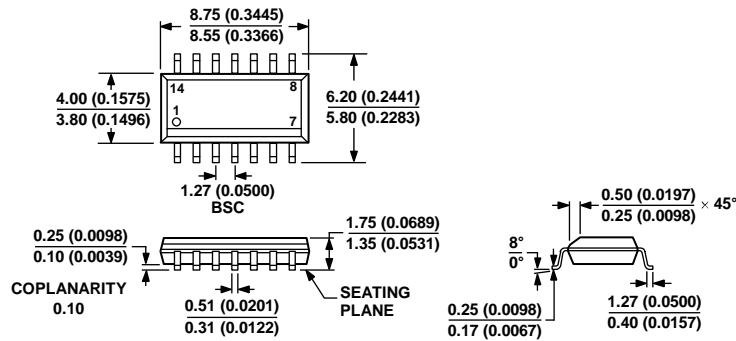

COMPLIANT TO JEDEC STANDARDS MS-012-AB  
CONTROLLING DIMENSIONS ARE IN MILLIMETERS; INCH DIMENSIONS (IN PARENTHESES) ARE ROUNDED-OFF MILLIMETER EQUIVALENTS FOR REFERENCE ONLY AND ARE NOT APPROPRIATE FOR USE IN DESIGN.

Figure 100. 14-Lead Standard Small Outline Package [SOIC\_N] Narrow Body (R-14)

Dimensions shown in millimeters and (inches)

060606-A

## ORDERING GUIDE

Model <sup>1</sup>	Temperature Range	Package Description	Package Option	Branding
ADA4177-1ARMZ	-40°C to +125°C	8-Lead Mini Small Outline Package [MSOP]	RM-8	A3E
ADA4177-1ARMZ-R7	-40°C to +125°C	8-Lead Mini Small Outline Package [MSOP]	RM-8	A3E
ADA4177-1ARMZ-RL	-40°C to +125°C	8-Lead Mini Small Outline Package [MSOP]	RM-8	A3E
ADA4177-1ARZ	-40°C to +125°C	8-Lead Standard Small Outline Package [SOIC_N]	R-8	
ADA4177-1ARZ-R7	-40°C to +125°C	8-Lead Standard Small Outline Package [SOIC_N]	R-8	
ADA4177-1ARZ-RL	-40°C to +125°C	8-Lead Standard Small Outline Package [SOIC_N]	R-8	
ADA4177-2ARMZ	-40°C to +125°C	8-Lead Mini Small Outline Package [MSOP]	RM-8	A36
ADA4177-2ARMZ-R7	-40°C to +125°C	8-Lead Mini Small Outline Package [MSOP]	RM-8	A36
ADA4177-2ARMZ-RL	-40°C to +125°C	8-Lead Mini Small Outline Package [MSOP]	RM-8	A36
ADA4177-2ARZ	-40°C to +125°C	8-Lead Standard Small Outline Package [SOIC_N]	R-8	
ADA4177-2ARZ-R7	-40°C to +125°C	8-Lead Standard Small Outline Package [SOIC_N]	R-8	
ADA4177-2ARZ-RL	-40°C to +125°C	8-Lead Standard Small Outline Package [SOIC_N]	R-8	
ADA4177-4ARUZ	-40°C to +125°C	14-Lead Thin Shrink Small Outline Package [TSSOP]	RU-14	
ADA4177-4ARUZ-R7	-40°C to +125°C	14-Lead Thin Shrink Small Outline Package [TSSOP]	RU-14	
ADA4177-4ARUZ-RL	-40°C to +125°C	14-Lead Thin Shrink Small Outline Package [TSSOP]	RU-14	
ADA4177-4ARZ	-40°C to +125°C	14-Lead Standard Small Outline Package [SOIC_N]	R-14	
ADA4177-4ARZ-R7	-40°C to +125°C	14-Lead Standard Small Outline Package [SOIC_N]	R-14	
ADA4177-4ARZ-RL	-40°C to +125°C	14-Lead Standard Small Outline Package [SOIC_N]	R-14	

<sup>1</sup> Z = RoHS Compliant Part.



Компания «ЭлектроПласт» предлагает заключение долгосрочных отношений при поставках импортных электронных компонентов на взаимовыгодных условиях!

Наши преимущества:

- Оперативные поставки широкого спектра электронных компонентов отечественного и импортного производства напрямую от производителей и с крупнейших мировых складов;
- Поставка более 17-ти миллионов наименований электронных компонентов;
- Поставка сложных, дефицитных, либо снятых с производства позиций;
- Оперативные сроки поставки под заказ (от 5 рабочих дней);
- Экспресс доставка в любую точку России;
- Техническая поддержка проекта, помощь в подборе аналогов, поставка прототипов;
- Система менеджмента качества сертифицирована по Международному стандарту ISO 9001;
- Лицензия ФСБ на осуществление работ с использованием сведений, составляющих государственную тайну;
- Поставка специализированных компонентов (Xilinx, Altera, Analog Devices, Intersil, Interpoint, Microsemi, Aeroflex, Peregrine, Syfer, Eurofarad, Texas Instrument, Miteq, Cobham, E2V, MA-COM, Hittite, Mini-Circuits, General Dynamics и др.);

Помимо этого, одним из направлений компании «ЭлектроПласт» является направление «Источники питания». Мы предлагаем Вам помощь Конструкторского отдела:

- Подбор оптимального решения, техническое обоснование при выборе компонента;
- Подбор аналогов;
- Консультации по применению компонента;
- Поставка образцов и прототипов;
- Техническая поддержка проекта;
- Защита от снятия компонента с производства.



#### Как с нами связаться

**Телефон:** 8 (812) 309 58 32 (многоканальный)

**Факс:** 8 (812) 320-02-42

**Электронная почта:** [org@eplast1.ru](mailto:org@eplast1.ru)

**Адрес:** 198099, г. Санкт-Петербург, ул. Калинина, дом 2, корпус 4, литера А.