

GaAs pHEMT MMIC 2 WATT POWER AMPLIFIER, DC - 22 GHz

Typical Applications

The HMC998A is ideal for:

- Test Instrumentation
- Microwave Radio & VSAT
- Military & Space
- Telecom Infrastructure
- Fiber Optics

Features

- High P1dB Output Power: +32.5 dBm
- High Psat Output Power: +33.5 dBm
- High Gain: 14.5 dB
- High Output IP3: 43 dBm
- Supply Voltage: +15 V @ 500 mA
- 50 Ohm Matched Input/Output
- Die Size: 2.98 x 1.78 x 0.1 mm

Functional Diagram

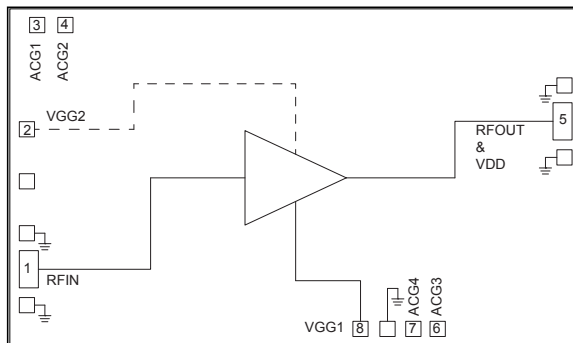

General Description

The HMC998A is a GaAs MMIC pHEMT Distributed Power Amplifier die which operates between DC and 22 GHz. The amplifier provides 14.5 dB of gain, 43 dBm output IP3 and +32.5 dBm of output power at 1 dB gain compression while requiring 500 mA quiescent current from a +15 V supply. The HMC998A exhibits a slightly positive gain slope, making it ideal for EW, ECM, Radar and test equipment applications. The HMC998A amplifier I/Os are internally matched to 50 Ohms facilitating integration into Multi-Chip-Modules (MCMs). All data is taken with the chip connected via two 0.025 mm (1 mil) wire bonds of minimal length 0.31 mm (12 mils).

Electrical Specifications, $T_A = +25^\circ\text{C}$, $V_{dd} = +15\text{V}$, $I_{dd} = 500\text{mA}^*$

Parameter	Min.	Typ.	Max.	Min.	Typ.	Max.	Min.	Typ.	Max.	Units
Frequency Range	DC - 2			2 - 18			18 - 22			GHz
Gain	13	15		12.5	14.5		12	14		dB
Gain Flatness		± 0.15			± 0.15			± 0.15		dB
Gain Variation Over Temperature		.006			.004			.009		dB/°C
Input Return Loss		14			18			15		dB
Output Return Loss		13			16			17		dB
Output Power for 1 dB Compression (P1dB)		29.5		30.5	32.5		29.5	31.5		dBm
Saturated Output Power (Psat)		34			33.5			33		dBm
Output Third Order Intercept (IP3)		41			43			41.5		dBm
Noise Figure		8			2.5			3		dB
Supply Current (Idd) (Vdd= 10V, Vgg1= -0.6V Typ.)		500			500			500		mA
Supply Voltage	11	15	15	11	15	15	11	15	15	V

* Adjust Vgg1 between -2 to 0 V to achieve Idd = 500 mA typical.

Product covered by one or more US and Foreign Patents: US Pat. Nos. 8,786,368; 9,425,752; Patents Pending.

Information furnished by Analog Devices is believed to be accurate and reliable. However, no responsibility is assumed by Analog Devices for its use, nor for any infringements of patents or other rights of third parties that may result from its use. Specifications subject to change without notice. No license is granted by implication or otherwise under any patent or patent rights of Analog Devices. Trademarks and registered trademarks are the property of their respective owners.

For price, delivery, and to place orders: Analog Devices, Inc., One Technology Way, P.O. Box 9106, Norwood, MA 02062-9106
Phone: 781-329-4700 • Order online at www.analog.com
Application Support: Phone: 1-800-ANALOG-D

**GaAs pHEMT MMIC
2 WATT POWER AMPLIFIER, DC - 22 GHz**

Gain & Return Loss

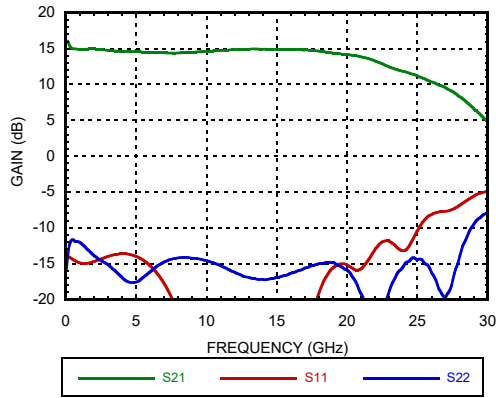

Low Frequency Gain & Return Loss

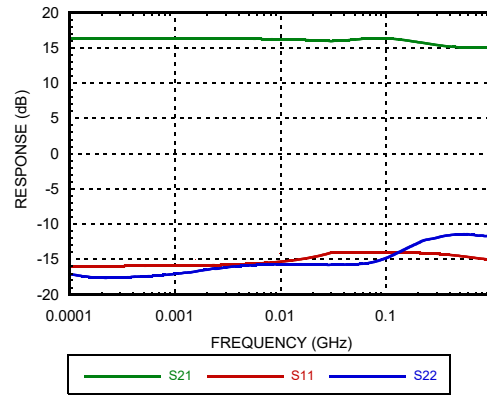

Gain vs. Temperature

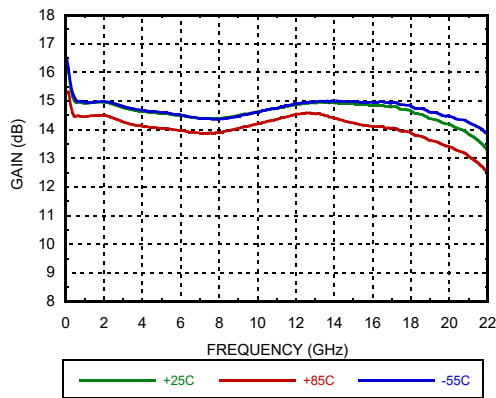

Gain vs. Vdd

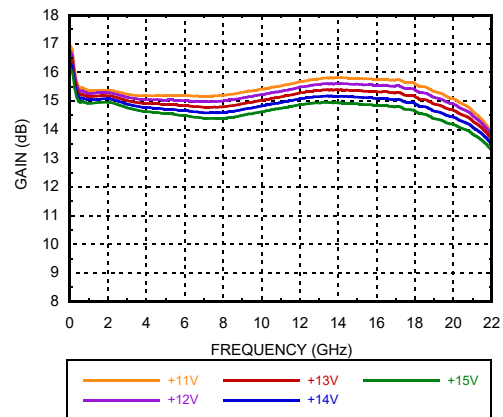

Gain vs. Idd

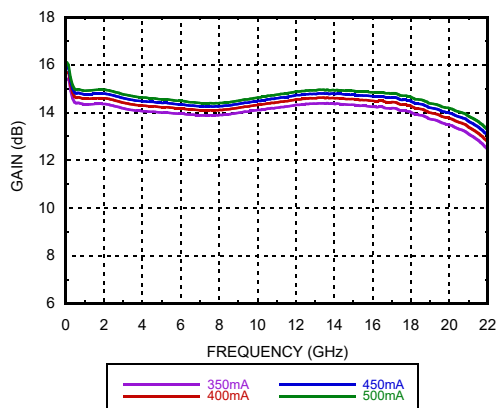

Input Return Loss vs. Temperature

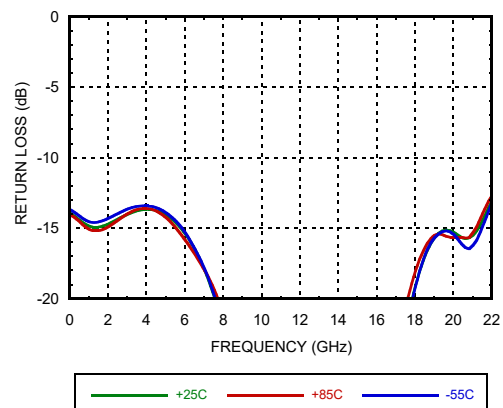

**GaAs pHEMT MMIC
2 WATT POWER AMPLIFIER, DC - 22 GHz**

Input Return Loss vs. Vdd

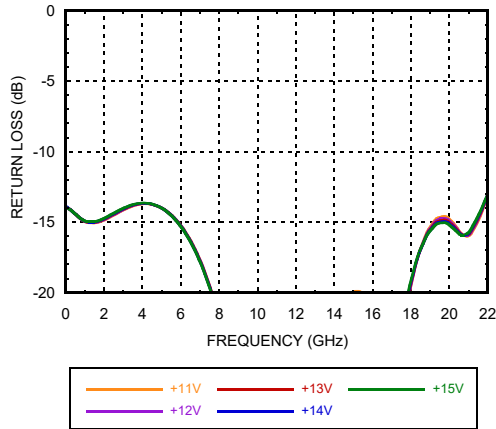

Input Return Loss vs. Idd

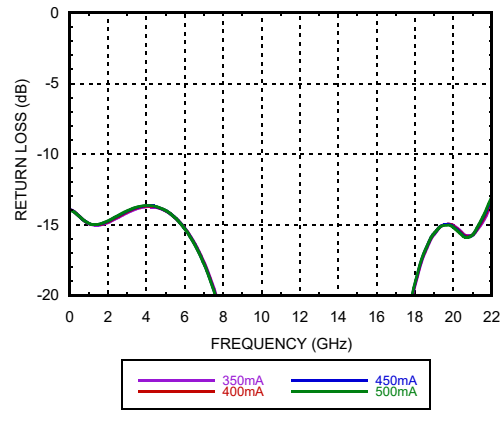

Output Return Loss vs. Temperature

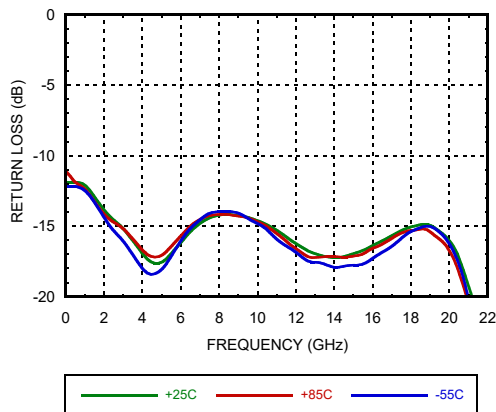

Output Return Loss vs. Vdd

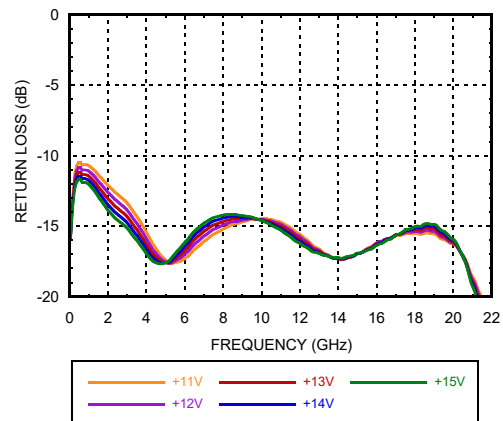

Output Return Loss vs. Idd

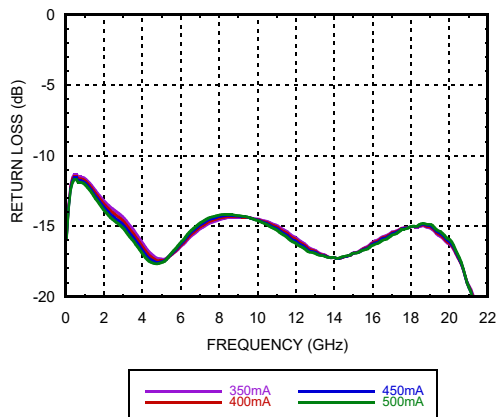

Reverse Isolation vs. Temperature

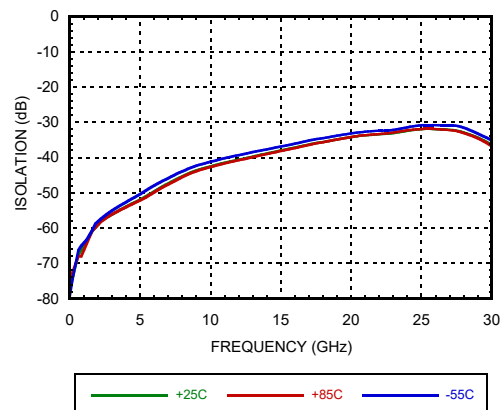

**GaAs pHEMT MMIC
2 WATT POWER AMPLIFIER, DC - 22 GHz**

Noise Figure vs. Temperature

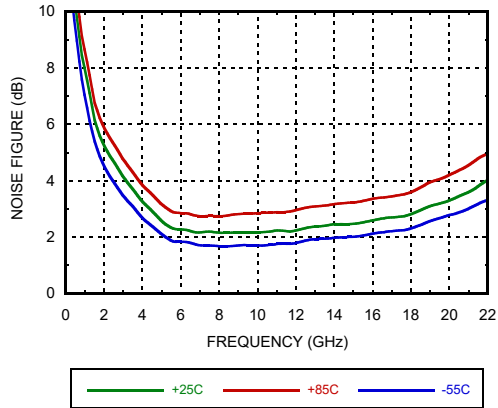

Noise Figure vs. I_{dd}

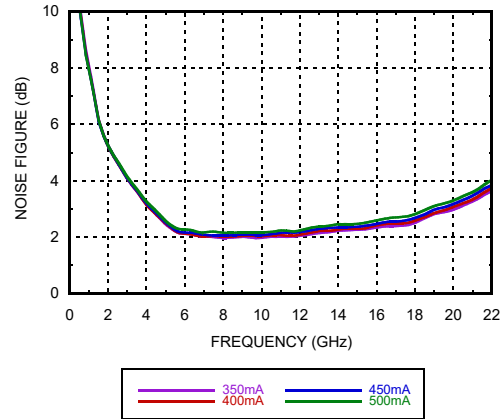

Low Frequency P_{1dB} vs. Temperature

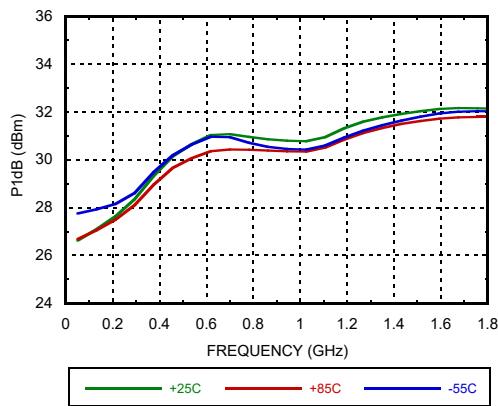

P_{1dB} vs. Temperature

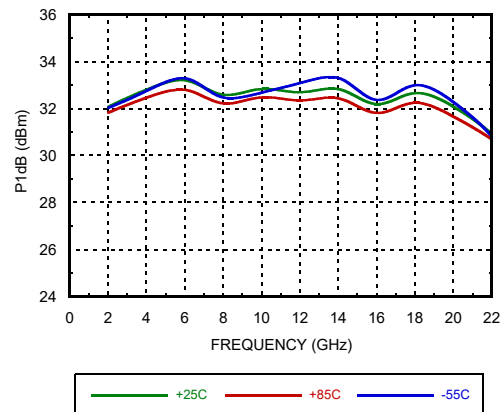

P_{1dB} vs. V_{dd}

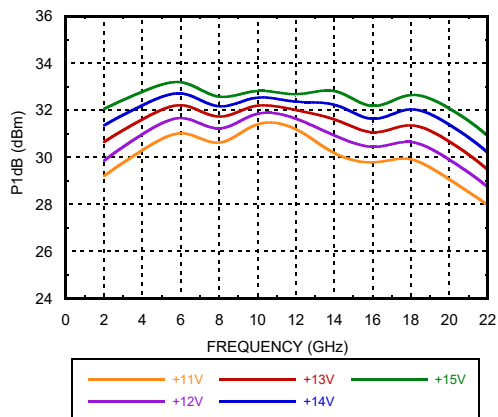

P_{1dB} vs. I_{dd}

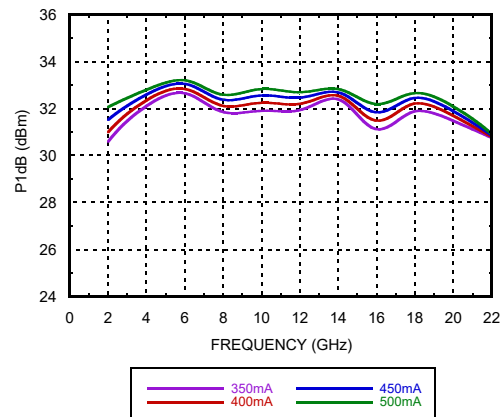

**GaAs pHEMT MMIC
2 WATT POWER AMPLIFIER, DC - 22 GHz**

AMPLIFIERS - LINEAR & POWER - CHIP

Low Frequency Psat vs. Temperature

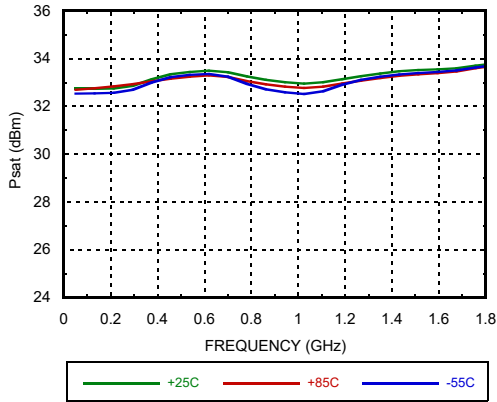

Psat vs. Temperature

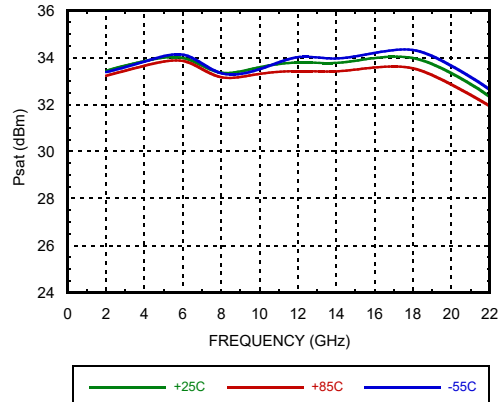

Psat vs. Vdd

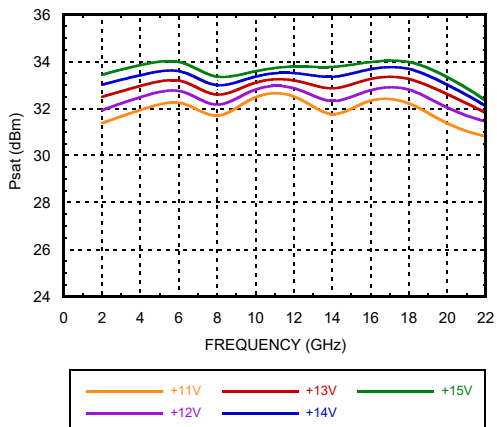

Psat vs. Idd

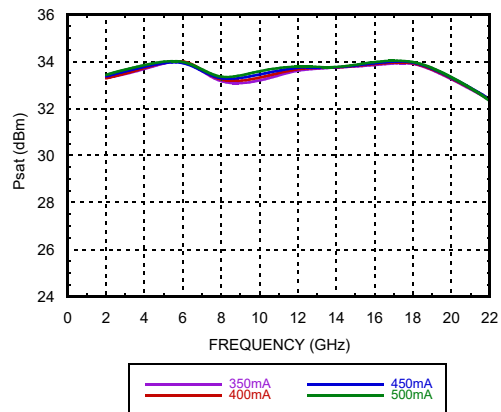

Power Compression @ 2 GHz

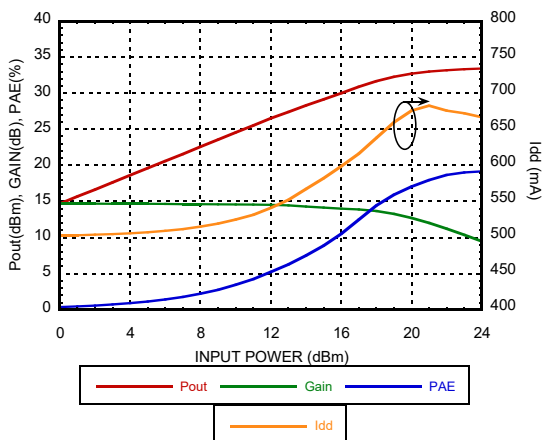

Power Compression @ 10 GHz

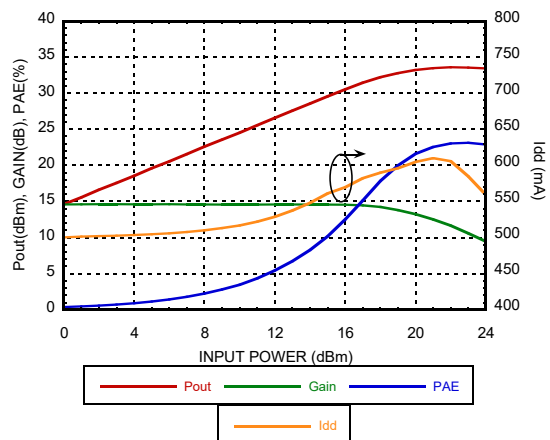

**GaAs pHEMT MMIC
2 WATT POWER AMPLIFIER, DC - 22 GHz**

Power Compression @ 22 GHz

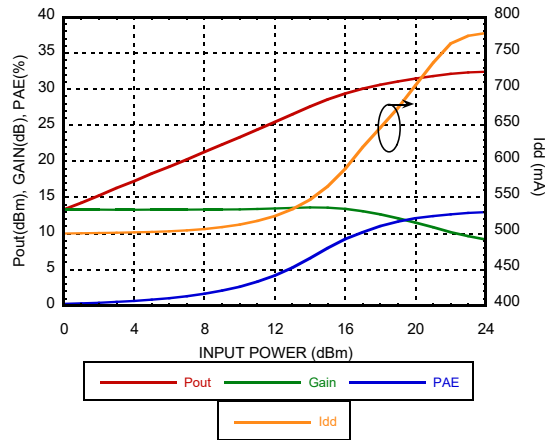

PAE @ Psat vs. Frequency

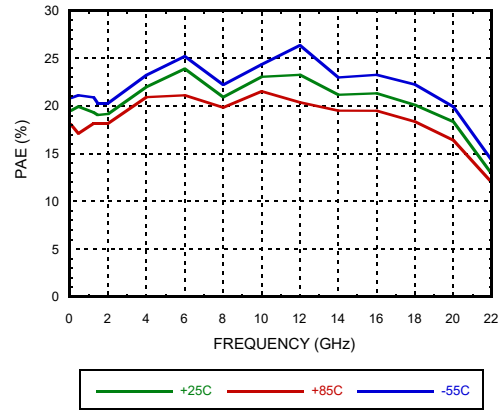

Power Dissipation @ 85C

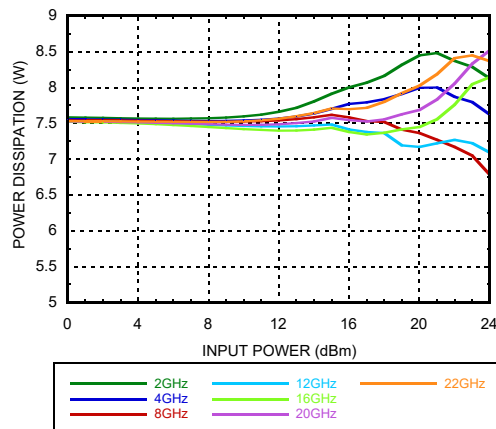

Gain & Power vs. Vdd @ 2 GHz

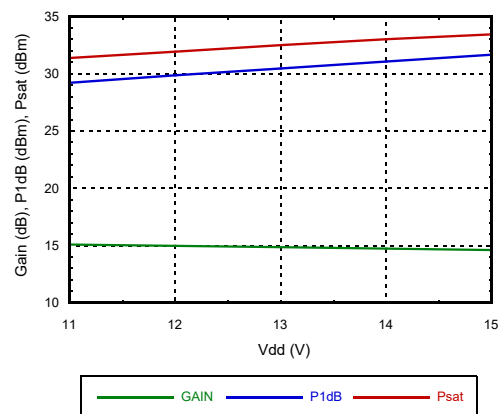

Gain & Power vs. Vdd @ 10 GHz

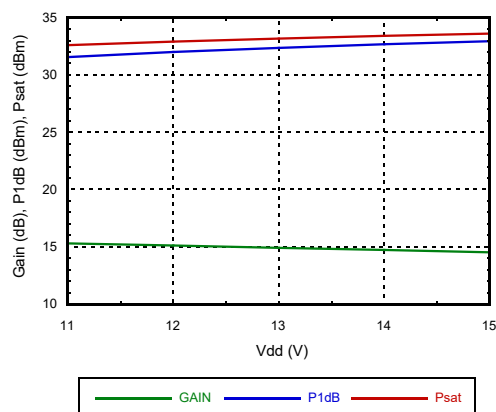

Gain & Power vs. Vdd @ 22 GHz

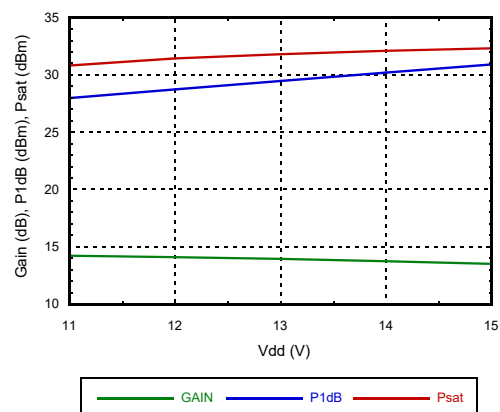

**GaAs pHEMT MMIC
2 WATT POWER AMPLIFIER, DC - 22 GHz**

Gain & Power vs. Idd @ 2 GHz

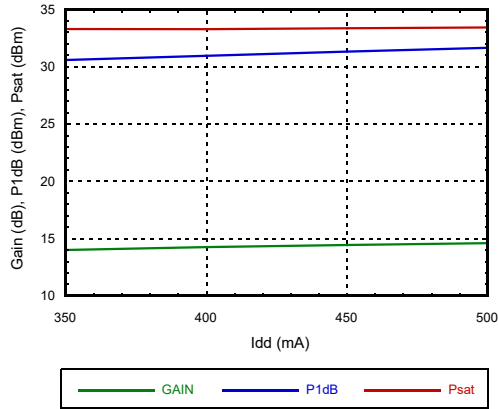

Gain & Power vs. Idd @ 10 GHz

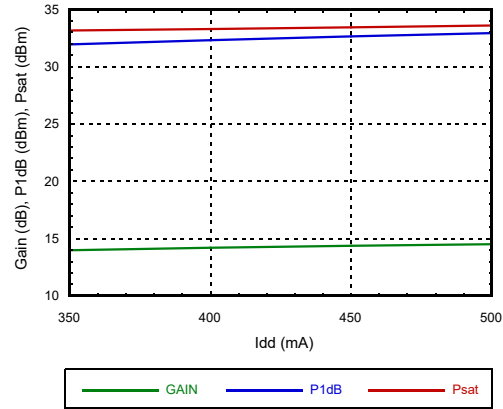

Gain & Power vs. Idd @ 22 GHz

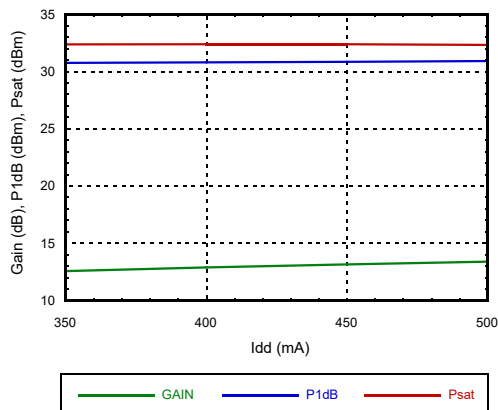

**Low Frequency Output IP3 vs. Temperature
@ Pout/Tone = +18 dBm**

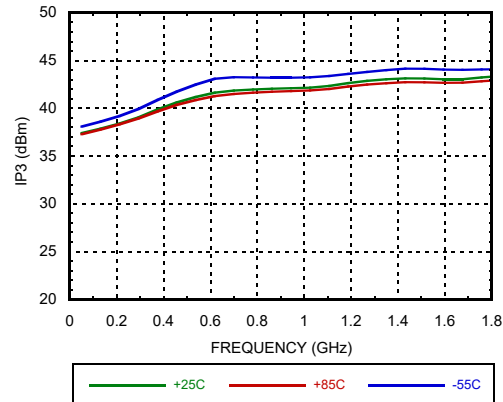

**Output IP3 vs. Temperature
@ Pout/Tone = +18 dBm**

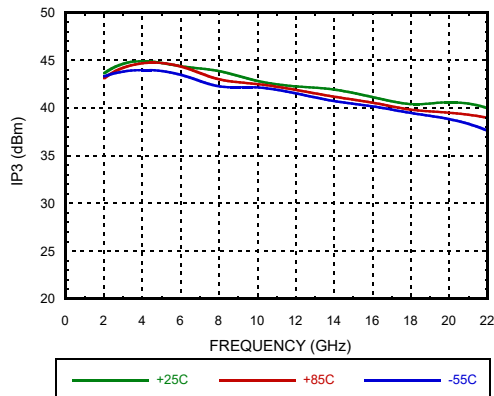

**Output IP3 vs. Vdd
@ Pout/Tone = +18 dBm**

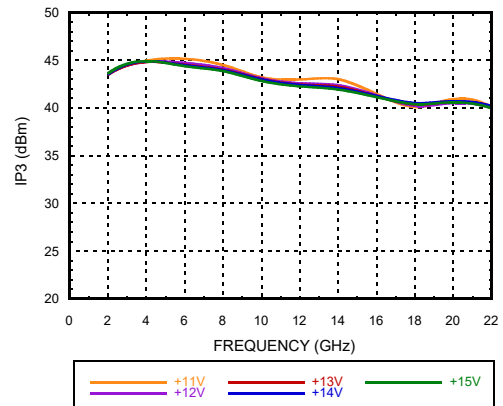

**GaAs pHEMT MMIC
2 WATT POWER AMPLIFIER, DC - 22 GHz**

**Output IP3 vs. I_{dd}
@ P_{out}/Tone = +18 dBm**

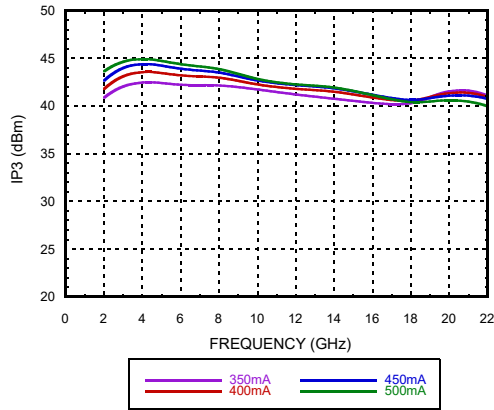

Output IM3 @ V_{dd} = +11V

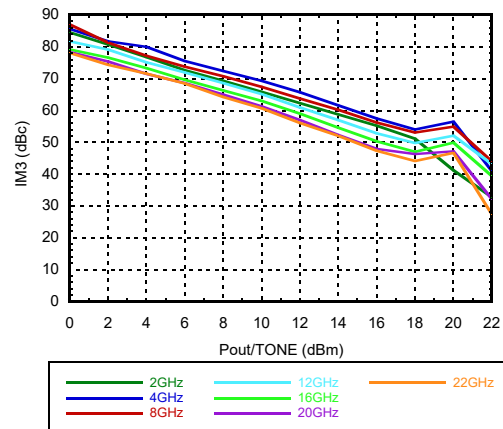

Output IM3 @ V_{dd} = +12V

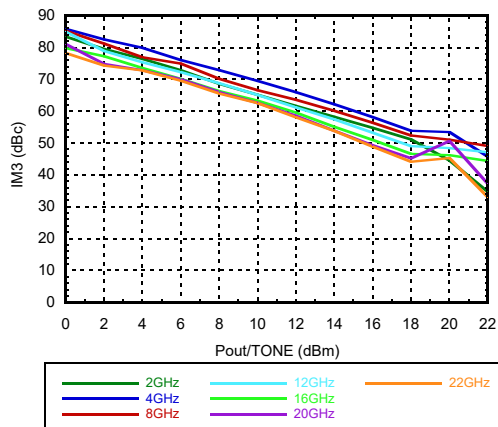

Output IM3 @ V_{dd} = +13V

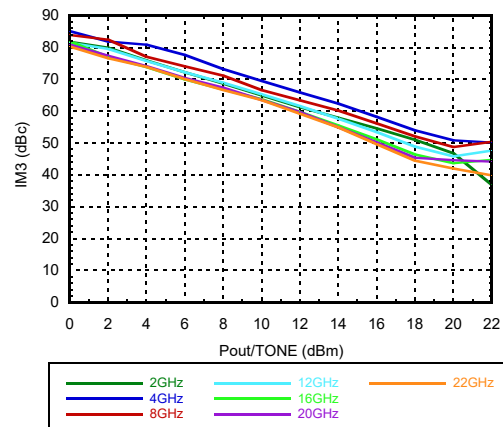

Output IM3 @ V_{dd} = +14V

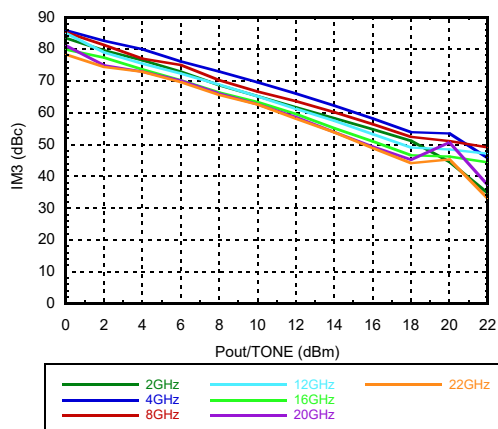

Output IM3 @ V_{dd} = +15V

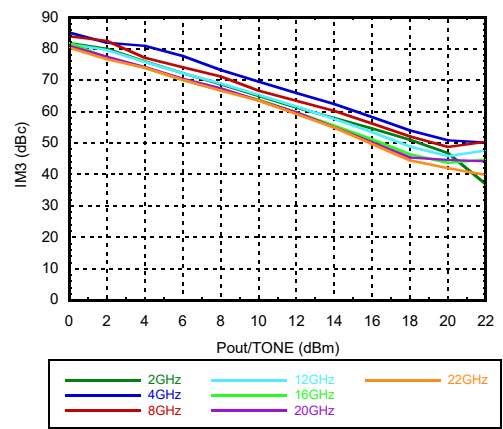

**GaAs pHEMT MMIC
2 WATT POWER AMPLIFIER, DC - 22 GHz**

**Second Harmonics vs. Temperature @
Pout = +18 dBm**

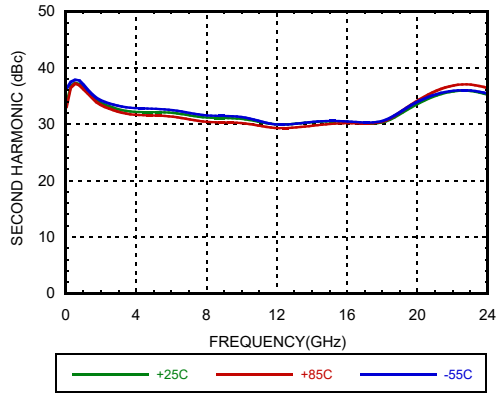

**Second Harmonics vs. Vdd @
Pout = +18 dBm**

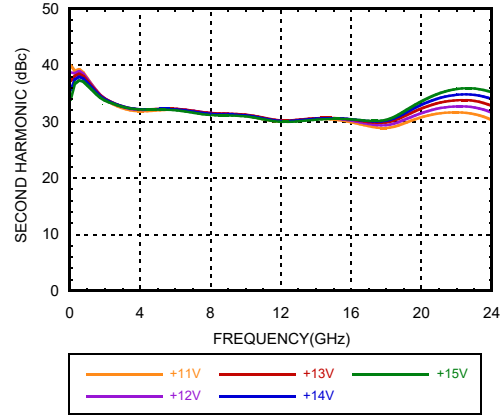

Second Harmonics vs. Pout

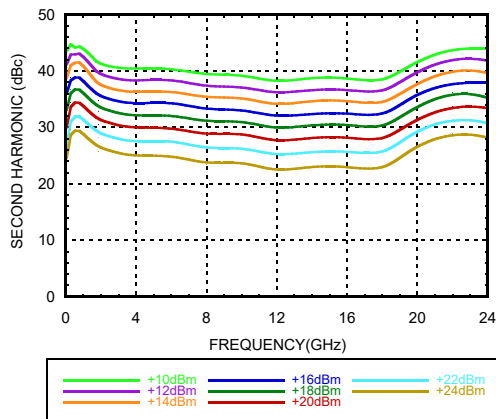

**Output IP2 vs. Temperature
@ Pout/Tone = +18 dBm**

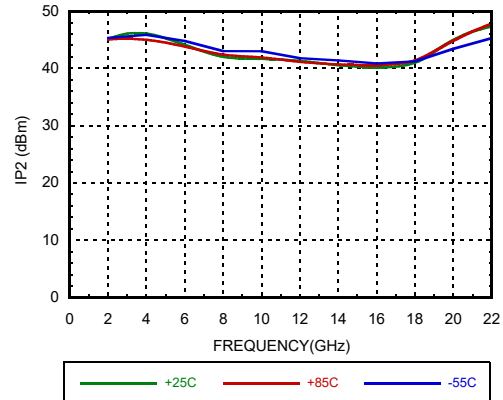

**Output IP2 vs. Vdd
@ Pout/Tone = +18 dBm**

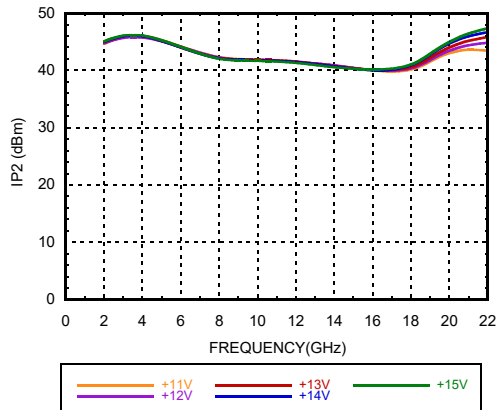

**Output IP2 vs. Idd
@ Pout/Tone = +18 dBm**

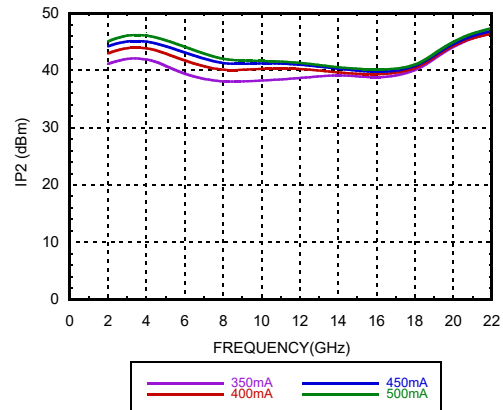

**GaAs pHEMT MMIC
2 WATT POWER AMPLIFIER, DC - 22 GHz**

I_{gg1} vs. Input Power

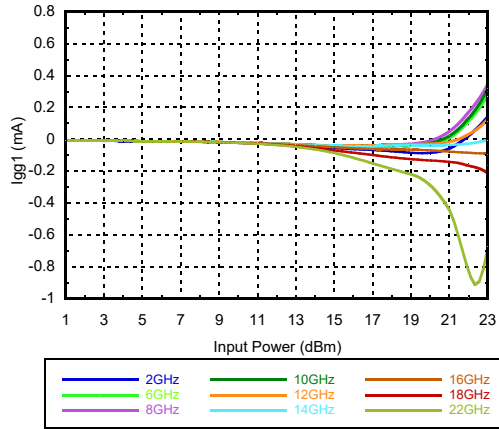

**I_{dd} vs. V_{gg1}
Representative of a Typical Device**

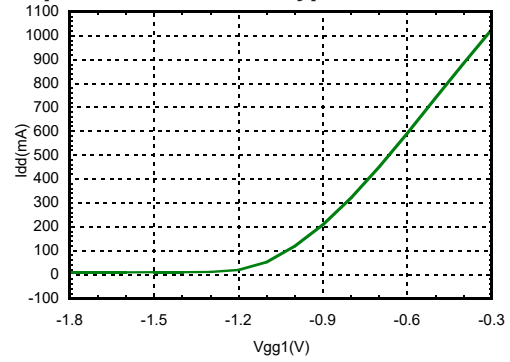

GaAs pHEMT MMIC 2 WATT POWER AMPLIFIER, DC - 22 GHz

Absolute Maximum Ratings

Drain Bias Voltage (Vdd)	16V
Gate Bias Voltage (Vgg1)	-3 to 0 Vdc
RF Input Power (RFIN)	27 dBm
Output Load VSWR	7:1
Continuous P _{diss} (T= 85 °C) (derate 113.6 mW/°C above 85 °C)	8.8W
Storage Temperature	-65 to 150 °C
Operating Temperature	-55 to 85 °C
ESD Sensitivity (HBM)	Passed 250V Class1A

Reliability Information

Channel Temperature	175 °C
Nominal Channel Temperature (T=85 °C, Vdd = 15V)	161.5 °C
Thermal Resistance (channel to die bottom)	10.2 °C/W

Stresses at or above those listed in the Absolute Maximum Ratings may cause permanent damage to the product. This is a stress rating only, functional operation of the product at these or any other conditions above those indicated in the operational section of this specification is not implied. Operation beyond the maximum operating condition for extended periods may affect product reliability.



**ELECTROSTATIC SENSITIVE DEVICE
OBSERVE HANDLING PRECAUTIONS**

Outline Drawing

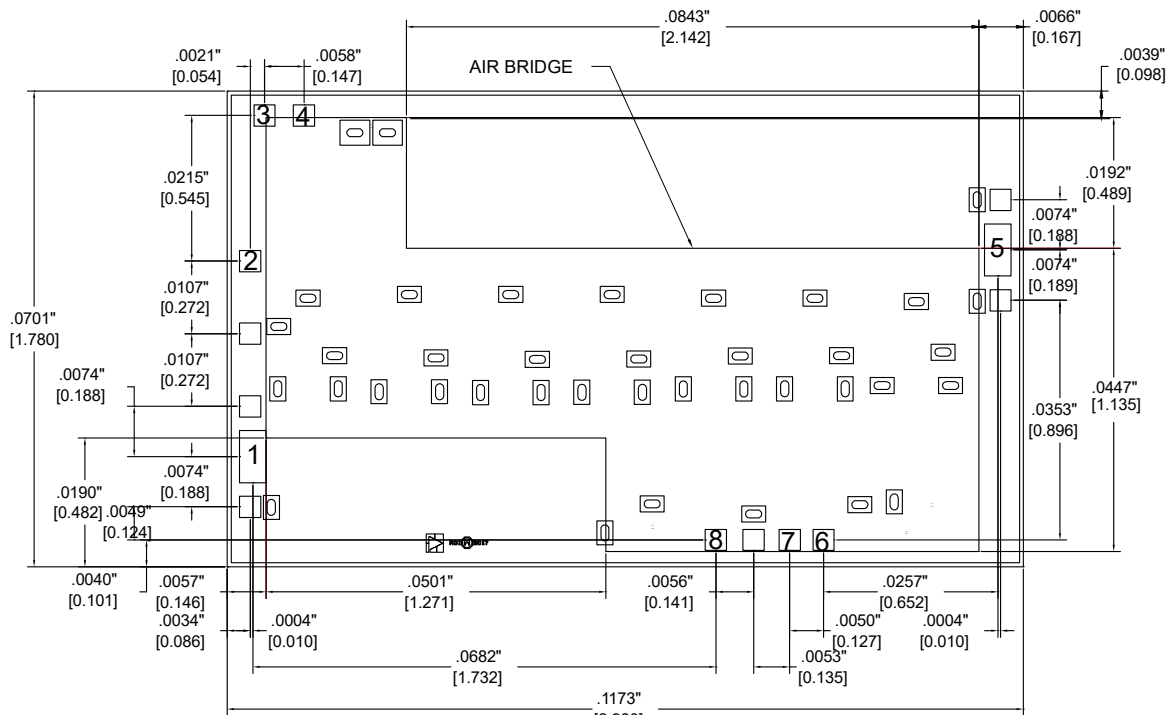

Die Packaging Information [1]

Standard	Alternate
GP-1 (Gel Pack)	[2]

[1] Refer to the "Packaging Information" section on our website for die packaging dimensions.



[2] For alternate packaging information contact Hittite Microwave Corporation.

NOTES:

- ALL DIMENSIONS IN INCHES [MILLIMETERS]
- DIE THICKNESS IS 0.004 (0.100)
- TYPICAL BOND PAD IS 0.0031 (0.079) SQUARE
- RF PADS ARE 0.0039 (0.098) X 0.0076 (0.193)
- BOND PAD METALLIZATION: GOLD
- BACKSIDE METALLIZATION: GOLD
- BACKSIDE METAL IS GROUND
- NO CONNECTION REQUIRED FOR UNLABELED BOND PADS
- OVERALL DIE SIZE IS ±.002

GaAs pHEMT MMIC 2 WATT POWER AMPLIFIER, DC - 22 GHz

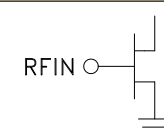
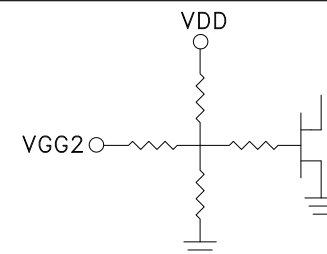
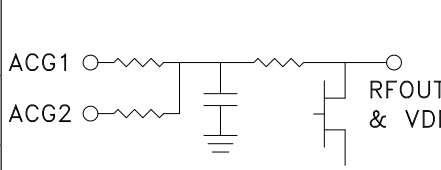
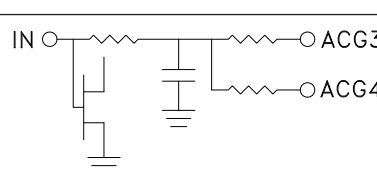
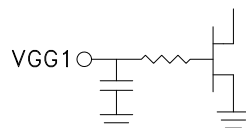
Pad Descriptions

Pad Number	Function	Description	Interface Schematic
1	RFIN	This pad is DC coupled and matched to 50 Ohms. Blocking capacitor is required.	
2	VGG2	Gate 2 for amplifier. Attach bypass capacitors per application circuit herein. Typical operation has VGG2 set internal to IC. Setting VGG2 to 9.5v externally can improve thermal resistance.	
3	ACG1	Low frequency termination. Attach bypass capacitor per application circuit herein.	
4	ACG2	Low frequency termination. Attach bypass capacitors per application circuit herein.	
5	RFOUT & VDD	RF output for amplifier. Connect DC bias (Vdd) network to provide drain current (Idd). See application circuit herein.	
6	ACG3	Low frequency termination. Attach bypass capacitors per application circuit herein.	
7	ACG4	Low frequency termination. Attach bypass capacitor per application circuit herein.	
8	VGG1	Gate control 1 for amplifier. Attach bypass capacitor per application circuit herein. Please follow "MMIC Amplifier Biasing Procedure" application note.	
Die Bottom	GND	Die bottom must be connected to RF/DC ground.	

**GaAs pHEMT MMIC
2 WATT POWER AMPLIFIER, DC - 22 GHz**

Application Circuit

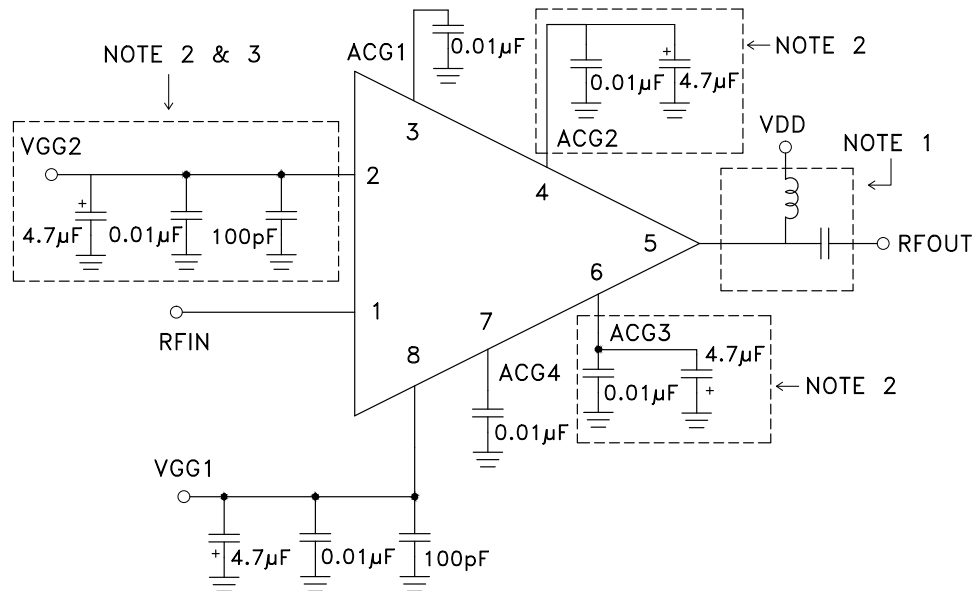

NOTE 1: Drain Bias (Vdd) must be applied through a broadband bias tee having low series resistance and capable of providing 1000 mA.

NOTE 2: Optional capacitors to be used if part is operated below 200 MHz.

NOTE 3: Optional capacitors to be used if external VGG2 is applied. Typical operation has VGG2 set internal to IC. Setting VGG2 to 9.5V externally can improve thermal resistance and will require capacitors as shown.

**GaAs pHEMT MMIC
2 WATT POWER AMPLIFIER, DC - 22 GHz**

Assembly Diagram

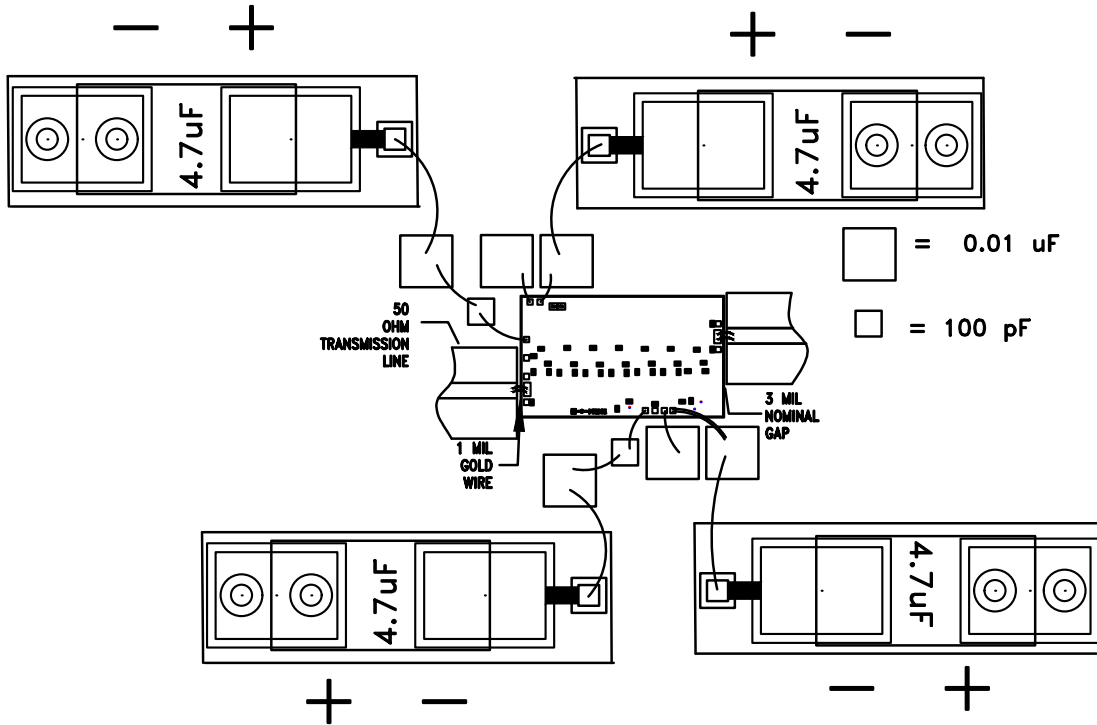

GaAs pHEMT MMIC 2 WATT POWER AMPLIFIER, DC - 22 GHz

Mounting & Bonding Techniques for Millimeterwave GaAs MMICs

The die should be attached directly to the ground plane eutectically or with conductive epoxy (see HMC general Handling, Mounting, Bonding Note).

50 Ohm Microstrip transmission lines on 0.127mm (5 mil) thick alumina thin film substrates are recommended for bringing RF to and from the chip (Figure 1). If 0.254mm (10 mil) thick alumina thin film substrates must be used, the die should be raised 0.150mm (6 mils) so that the surface of the die is coplanar with the surface of the substrate. One way to accomplish this is to attach the 0.102mm (4 mil) thick die to a 0.150mm (6 mil) thick molybdenum heat spreader (moly-tab) which is then attached to the ground plane (Figure 2).

Microstrip substrates should be placed as close to the die as possible in order to minimize bond wire length. Typical die-to-substrate spacing is 0.076mm to 0.152 mm (3 to 6 mils).

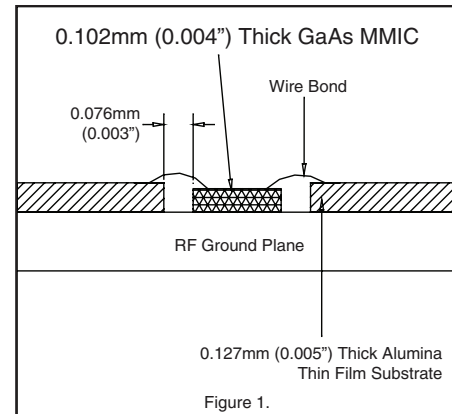

Handling Precautions

Follow these precautions to avoid permanent damage.

Storage: All bare die are placed in either Waffle or Gel based ESD protective containers, and then sealed in an ESD protective bag for shipment. Once the sealed ESD protective bag has been opened, all die should be stored in a dry nitrogen environment.

Cleanliness: Handle the chips in a clean environment. DO NOT attempt to clean the chip using liquid cleaning systems.

Static Sensitivity: Follow ESD precautions to protect against ESD strikes.

Transients: Suppress instrument and bias supply transients while bias is applied. Use shielded signal and bias cables to minimize inductive pick-up.

General Handling: Handle the chip along the edges with a vacuum collet or with a sharp pair of bent tweezers. The surface of the chip may have fragile air bridges and should not be touched with vacuum collet, tweezers, or fingers.

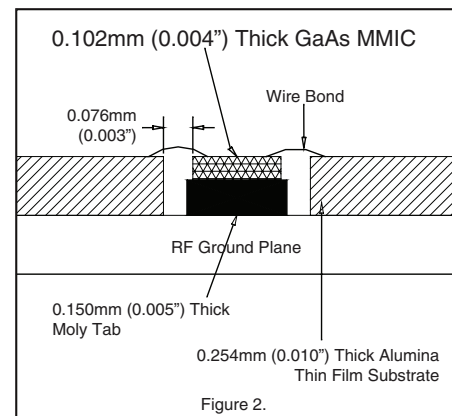

Mounting

The chip is back-metallized and can be die mounted with AuSn eutectic preforms or with electrically conductive epoxy. The mounting surface should be clean and flat.

Eutectic Die Attach: A 80/20 gold tin preform is recommended with a work surface temperature of 255 °C and a tool temperature of 265 °C. When hot 90/10 nitrogen/hydrogen gas is applied, tool tip temperature should be 290 °C. DO NOT expose the chip to a temperature greater than 320 °C for more than 20 seconds. No more than 3 seconds of scrubbing should be required for attachment.

Epoxy Die Attach: Apply a minimum amount of epoxy to the mounting surface so that a thin epoxy fillet is observed around the perimeter of the chip once it is placed into position. Cure epoxy per the manufacturer's schedule.

Wire Bonding

RF bonds made with two 1 mil wires are recommended. These bonds should be thermosonically bonded with a force of 40-60 grams. DC bonds of 0.001" (0.025 mm) diameter, thermosonically bonded, are recommended. Ball bonds should be made with a force of 40-50 grams and wedge bonds at 18-22 grams. All bonds should be made with a nominal stage temperature of 150 °C. A minimum amount of ultrasonic energy should be applied to achieve reliable bonds. All bonds should be as short as possible, less than 12 mils (0.31 mm).

**GaAs pHEMT MMIC
2 WATT POWER AMPLIFIER, DC - 22 GHz**

Notes:



Компания «ЭлектроПласт» предлагает заключение долгосрочных отношений при поставках импортных электронных компонентов на взаимовыгодных условиях!

Наши преимущества:

- Оперативные поставки широкого спектра электронных компонентов отечественного и импортного производства напрямую от производителей и с крупнейших мировых складов;
- Поставка более 17-ти миллионов наименований электронных компонентов;
- Поставка сложных, дефицитных, либо снятых с производства позиций;
- Оперативные сроки поставки под заказ (от 5 рабочих дней);
- Экспресс доставка в любую точку России;
- Техническая поддержка проекта, помощь в подборе аналогов, поставка прототипов;
- Система менеджмента качества сертифицирована по Международному стандарту ISO 9001;
- Лицензия ФСБ на осуществление работ с использованием сведений, составляющих государственную тайну;
- Поставка специализированных компонентов (Xilinx, Altera, Analog Devices, Intersil, Interpoint, Microsemi, Aeroflex, Peregrine, Syfer, Eurofarad, Texas Instrument, Miteq, Cobham, E2V, MA-COM, Hittite, Mini-Circuits, General Dynamics и др.);

Помимо этого, одним из направлений компании «ЭлектроПласт» является направление «Источники питания». Мы предлагаем Вам помощь Конструкторского отдела:

- Подбор оптимального решения, техническое обоснование при выборе компонента;
- Подбор аналогов;
- Консультации по применению компонента;
- Поставка образцов и прототипов;
- Техническая поддержка проекта;
- Защита от снятия компонента с производства.



Как с нами связаться

Телефон: 8 (812) 309 58 32 (многоканальный)

Факс: 8 (812) 320-02-42

Электронная почта: org@eplast1.ru

Адрес: 198099, г. Санкт-Петербург, ул. Калинина, дом 2, корпус 4, литера А.