



Honeywell Zephyr™ Analog Airflow Sensors

HAF Series—High Accuracy
±50 SCCM to ±750 SCCM



Honeywell Zephyr™ Analog Airflow Sensors

HAF Series - High Accuracy

Honeywell Zephyr™ HAF Series sensors provide an analog interface for reading airflow over specified full-scale flow and compensated temperature ranges. The thermally isolated heater and temperature sensing elements help these sensors provide a fast response to air or gas flow.

Zephyr sensors are designed to measure mass flow of air and other non-corrosive gases. Standard flow ranges are available at ± 50 , ± 100 , ± 200 , ± 400 or ± 750 SCCM. Custom flow ranges are also available. The sensors are fully calibrated and temperature compensated with an onboard Application Specific Integrated Circuit (ASIC).

The HAF Series is compensated over the temperature range of 0 °C to 50 °C [32 °F to 122 °F] and operates across a temperature range of -20 °C to 70 °C [-4 °F to 158 °F]. The state-of-the-art ASIC-based compensation provides analog outputs with a response time of 1 ms.

These sensors operate on the heat transfer principle to measure mass airflow. They consist of a microbridge Microelectronic and Microelectromechanical System (MEMS) with temperature-sensitive resistors deposited with thin films of platinum and silicon nitride. The MEMS sensing die is located in a precise and carefully designed airflow channel to provide repeatable response to flow.

Zephyr sensors provide the customer with enhanced reliability, high accuracy, repeatable measurements and the ability to customize sensor options to meet many specific application needs. The combination of rugged housings with a stable substrate makes these products extremely robust. They are designed and manufactured according to ISO 9001 standards

What makes our sensors better?

- **Fast response time**
- **Wide range of airflows**
- **Customizable flow ranges and configurable package styles**
- **Linear output**
- **High stability**
- **Low pressure drop**



TIGHT TOTAL ERROR BAND • FAST RESPONSE TIME • WIDE RANGE OF AIRFLOWS

Features and Benefits

FAST RESPONSE TIME*

Allows a customer's application to respond quickly to airflow change, important in critical medical (e.g., anesthesia) and industrial (e.g., fume hood) applications.

WIDE RANGE OF AIRFLOWS*

Zephyr measures mass flow at standard flow ranges of ± 50 , ± 100 , ± 200 , ± 400 or ± 750 SCCM, or custom flow ranges, increasing the options for integrating the sensor into the application.

CUSTOMIZABLE FLOW RANGES AND CONFIGURABLE PACKAGE STYLES*

Meet specific end-user needs.

FULL CALIBRATION AND TEMPERATURE COMPENSATION

Typically allow customer to remove additional components associated with signal conditioning from the PCB, reducing PCB size as well as costs often associated with those components (e.g., acquisition, inventory, assembly).

LINEAR OUTPUT*

Provides more intuitive sensor signal than the raw output of basic airflow sensors, which can help reduce production costs, design, and implementation time.

LOW PRESSURE DROP*

Typically improves patient comfort in medical applications, and reduces noise and system wear on other components such as motors and pumps.

0.049 %FS RESOLUTION

Increases ability to sense small airflow changes, allowing customers to more precisely control their application.

LOW 3.3 VDC OPERATING VOLTAGE OPTION AND LOW POWER CONSUMPTION

Allow for use in battery-driven and other portable applications.

SMALL SIZE

Occupies less space on PCB, allowing easier fit and potentially reducing production costs; PCB size may also be reduced for easier fit into space-constrained applications.

ROHS-COMPLIANT MATERIALS

Meet Directive 2002/95/EC.

Potential Applications



MEDICAL

ANESTHESIA DELIVERY MACHINES

VENTRICULAR ASSIST DEVICES (HEART PUMPS)

NEBULIZERS

OXYGEN CONCENTRATORS

PATIENT MONITORING SYSTEMS (RESPIRATORY MONITORING)

SLEEP APNEA MACHINES

SPIROMETERS

VENTILATORS

LAPAROSCOPY



INDUSTRIAL

AIR-TO-FUEL RATIO

FUEL CELLS

GAS LEAK DETECTION

VAV SYSTEM ON HVAC SYSTEMS

GAS METERS

HVAC FILTERS



±50 SCCM to ±750 SCCM

Table 1. Absolute Maximum Ratings¹

Characteristic	Parameter
Supply voltage	-0.3 Vdc to 6.0 Vdc
Voltage on I/O output pin	-0.3 Vdc to Vsupply
Storage temperature range	-40 °C to 125 °C [-40 °F to 257 °F]
Maximum flow change	5.0 SLPM/s
Maximum common mode pressure	25 psi at 25 °C [77 °F]
Maximum flow	10 SLPM

¹Absolute maximum ratings are the extreme limits that the device will withstand without damage to the device. However, the electrical and mechanical characteristics are not guaranteed as the maximum limits (above recommended operating conditions) are approached, nor will the device necessarily operate at absolute maximum ratings.

CAUTION

IMPROPER USE

Do not use these products to sense liquid flow

Failure to comply with these instructions may result in product damage.

CAUTION

PRODUCT DAMAGE

Do not disassemble these products.

Failure to comply with these instructions may result in product damage.

Table 2. Operating Specifications

Characteristic	Parameter	Note
Supply voltage 3.3 Vdc 5.0 Vdc	3.3 Vdc ±10% 5.0 Vdc ±10%	–
Power: 3.3 Vdc 5.0 Vdc	40 mW max. 65 mW max.	1
Compensated temperature range	0 °C to 50 °C [32 °F to 122 °F]	2
Operating temperature range	-20 °C to 70 °C [-4 °F to 158 °F]	
Accuracy	See Table 3.	3, 4
Total Error Band (TEB)	See Table 3.	4, 5
Null accuracy	±0.1 %FSS	4, 6
Response time	1 ms typ.	7
Resolution	12 bit	–
Warm-up time	15 ms	8
Calibration media	gaseous nitrogen	9
Null stability	±0.06 %FSS max. deviation from null output after 1000 hrs at 25 °C	–
Reverse polarity protection	no	–

¹Maximum power: Is measured under the conditions of the highest supply voltage, Vsupply + 10%, 70 °C, full scale flow and with the minimum load specified for that supply voltage.

²Custom and extended compensated temperature ranges are possible. Contact Honeywell for details.

³Accuracy: The maximum deviation from the nominal output over the compensated flow range at a reference temperature of 25 °C. Errors include offset, span, non-linearity, hysteresis and non-repeatability.

⁴Full Scale Span (FSS): The algebraic difference between the output at the forward Full Scale (FS) flow and the output at the reverse FS flow. Forward flow is defined as flow from P1 to P2 as shown in Figure 9. The references to mass flow (SCCM) refer to gas flows at the standard conditions of 0 °C and atmospheric pressure 760 (101.3 kPa).

⁵Total Error Band: The maximum deviation in output from the ideal transfer function over the entire compensated temperature and flow range. Includes all errors due to offset, full scale span, flow hysteresis, flow repeatability, thermal effect on offset, thermal effect on span and thermal hysteresis.

⁶Null accuracy: The maximum deviation in output at 0 SCCM from the ideal transfer function over the compensated temperature range. This includes offset errors, thermal airflow hysteresis and repeatability errors.

⁷Response time: The time to electrically respond to any mass flow change at the microbridge airflow transducer (response time of the transducer may be affected by the pneumatic interface).

⁸Warm-up time: The time to the first valid flow measurement after power is applied.

⁹Default calibration media is dry nitrogen gas. Please contact Honeywell for other calibration options.

Honeywell Zephyr™ Analog Airflow Sensors

HAF Series–High Accuracy

Table 3. Bidirectional Forward Flow Optimization

Sensor Range (SCCM)	Accuracy Error Band		Total Error Band	
	Applied Flow (SCCM)	Error (%FSS)	Applied Flow (SCCM)	Error (%FSS)
±50	-50 to -14.3	±7% reading	-50 to -11.3	±9% reading
	-14.3 to 0	±1	-11.1 to 0	±1
	0	±0.32	0	±0.32
	0 to 20	±1	0 to 11.1	±1
	20 to 50	±5% reading	11.1 to 50	±9% reading
±100	-100 to -11.1	±9% reading	-100 to -8.3	±12% reading
	-11.1 to 0	±0.5	-8.3 to 0	±0.5
	0	±0.16	0	±0.16
	0 to 16.7	±0.5	0 to 16.7	±0.5
	16.7 to 100	±6% reading	16.7 to 100	±6% reading
±200 ¹	-200 to -6.7	±15% reading	-200 to -6.7	±15% reading
	-6.7 to -0	±0.25	-6.7 to -0	±0.25
	0	±0.1	0	±0.1
	0 to 40	±0.25	0 to 22.2	±0.25
	40 to 200	±2.5% reading	22.2 to 200	±4.5% reading
±400	-400 to -32	±10% reading	-400 to -32	±12% reading
	-32 to -0	±0.4	-32 to -0	±0.45
	0	±0.1	0	±0.1
	0 to 80	±0.4	0 to 60	±0.45
	80 to 400	±4.0% reading	60 to 400	±6% reading
±750	-750 to -25	±15% reading	-750 to -25	±15% reading
	-25 to -0	±0.25	-25 to -0	±0.25
	0	±0.1	0	±0.1
	0 to 37.5	±0.25	0 to 37.5	±0.25
	37.5 to 750	±10% reading	37.5 to 750	±10% reading

¹The short port sensors are only specified down to -100 SCCM.

±50 SCCM to ±750 SCCM

Table 4. Suggested Load

Characteristic	Parameter
Minimum suggested resistance: 3.3 Vdc 5.0 Vdc	3.3 kOhm 5 kOhm
Maximum suggested capacitance: 3.3 Vdc 5.0 Vdc	10 nF 10 nF

CAUTION

LARGE PARTICULATE DAMAGE

Use a 5-micron filter upstream of the sensor to keep media flow through the sensor free of condensing moisture and particulates. Large, high-velocity particles or conductive particles may damage the sensing element.

Failure to comply with these instructions may result in product damage.

Table 5. Environmental Characteristics

Characteristic	Parameter
Humidity	0% to 95% RH, non-condensing
Shock	100 g, 11 ms
Vibration	15 g at 20 Hz to 2000 Hz
ESD	Class 3B per MIL-STD 883G

Table 6. Wetted Materials

Characteristic	Parameter
Covers	high temperature polymer
Substrate	PCB
Adhesives	epoxy
Electronic components	silicon, gold
Compliance	RoHS, WEEE

Table 7. Recommended Mounting and Implementation

Characteristic	Parameter
Mounting screw: size torque	5-40 0,68 N m [6 in-lb]
Silicon tubing for long port style	70 durometer; size 0.125 in inside diameter, 0.250 in outside diameter silicone tubing
O-ring: for short port style for long port style	AS568A, Size 7, Silicone, Shore A 70 AS568A, Size 10, Silicone, Shore A 70
Filter	5-micron filter upstream of the sensor

Figure 2. Nominal Analog Output



Honeywell Zephyr™ Analog Airflow Sensors

HAF Series—High Accuracy

Figure 3. Ideal Transfer Function

$$V_o = V_s \left\{ 0.5 + 0.4 \frac{F_A}{F_{FS}} \right\}$$

$$F_A = \frac{F_{FS} (V_o / V_s - 0.5)}{0.4}$$

Where:

V_o = output voltage of the device

V_s = supply voltage measured at the device

F_A = flow applied across the device

F_{FS} = full scale flow specified for the device

Figure 4. Nomenclature and Order Guide

For example, a **HAFBLF0200CAAX5** part number defines a Honeywell Zephyr™ Analog Airflow Sensor, bidirectional forward flow optimized, long port, fastener mount, 200 SCCM, analog output, 10% to 90% transfer function, 5.0 Vdc supply voltage.

HAF	B	L	F	0200	C	A	A	X	5
Product Series	Flow Direction	Port Style	Housing Style	Flow Range ²	Unit	Output Format	Transfer Function	Reserved for Future Use	Supply Voltage
HAF Series High Accuracy Airflow Sensor	B Bidirectional forward flow optimized	L Long port ¹	F Fastener mount	0050 50 long port style only	C SCCM	A Analog	A 10% to 90% of Full Scale Output (FSO)	X XXXXX	3 3.3 Vdc
	S Bidirectional symmetric	S Short port	S Snap mount ¹	0100 100 long port style only					5 5.0 Vdc
				0200 200 long or short port					
				0400 400 long port style only					
				0750 750 long port style only					

¹The Long Port Port Style with the Snap Mount Housing Style is not a valid configuration.

²The 200 SCCM Flow Range is available in the Long and Short Port Styles.

Apart from the general configuration required, other customer-specific requirements are also possible. Please contact Honeywell.

Figure 5. All Available Standard Configurations

LF: Long port, fastener mount



SF: Short port, fastener mount



SS: Short port, snap mount



±50 SCCM to ±750 SCCM

Figure 6. Wave Solder Profile

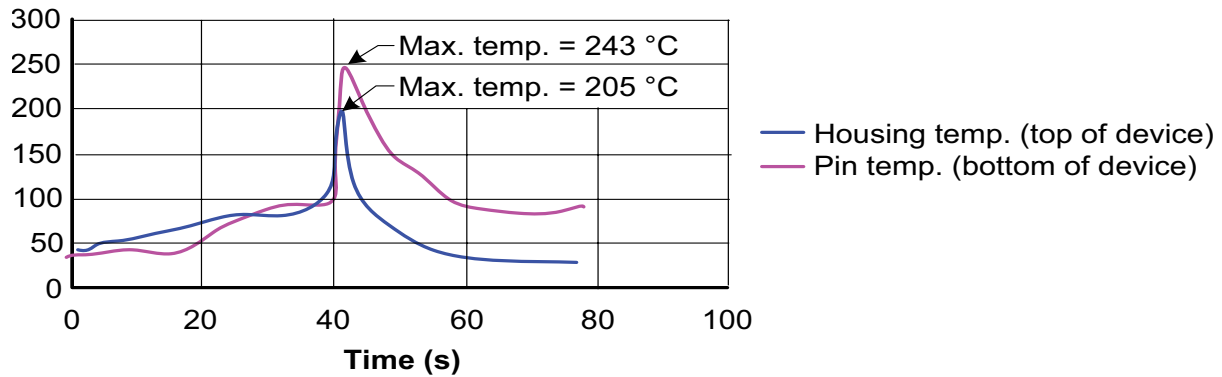

Figure 7. Long Port Style Flow vs Pressure



Flow (SCCM)	Typical Pressure Drop		
	mbar	inH ₂ O	Pa
-750	-0.2517	-0.1011	-25.17
-550	-0.1499	-0.0602	-14.99
-400	-0.0891	-0.0358	-8.91
-300	-0.0578	-0.0232	-5.78
-200	-0.0321	-0.0129	-3.21
-100	-0.0114	-0.0046	-1.14
-50	-0.0035	-0.0014	-0.35
-20	-0.0007	-0.0003	-0.07
0	0.0000	0.0000	0.0000
20	0.0007	0.0003	0.07
50	0.0035	0.0014	0.35
100	0.0114	0.0046	1.14
200	0.0321	0.0129	3.21
300	0.0578	0.0232	5.78
400	0.0891	0.0358	8.91
550	0.1499	0.0602	14.99
750	0.2517	0.1011	25.17

Figure 8. Short Port Style Flow vs Pressure



Flow (SCCM)	Typical Pressure Drop		
	mbar	inH ₂ O	Pa
-200	-1.1707	-0.470	-117.07
-150	-0.7074	-0.284	-70.74
-100	-0.3562	-0.143	-35.62
-50	-0.1120	-0.045	-11.20
0	0.0000	0.000	0.0000
50	0.1196	0.048	11.96
100	0.3462	0.139	34.62
150	0.7149	0.287	71.49
200	1.2589	0.452	125.89

Honeywell Zephyr™ Analog Airflow Sensors

HAF Series—High Accuracy

Figure 9. Mounting Dimensions (For reference only: mm [in].)

LF: Long port, fastener mount



Mounting Footprint

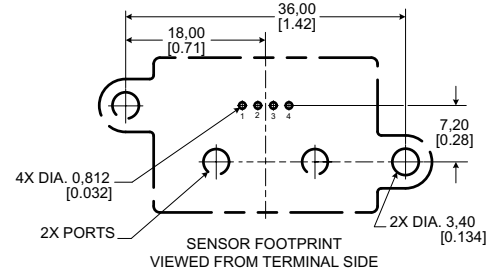

SF: Short port, fastener mount

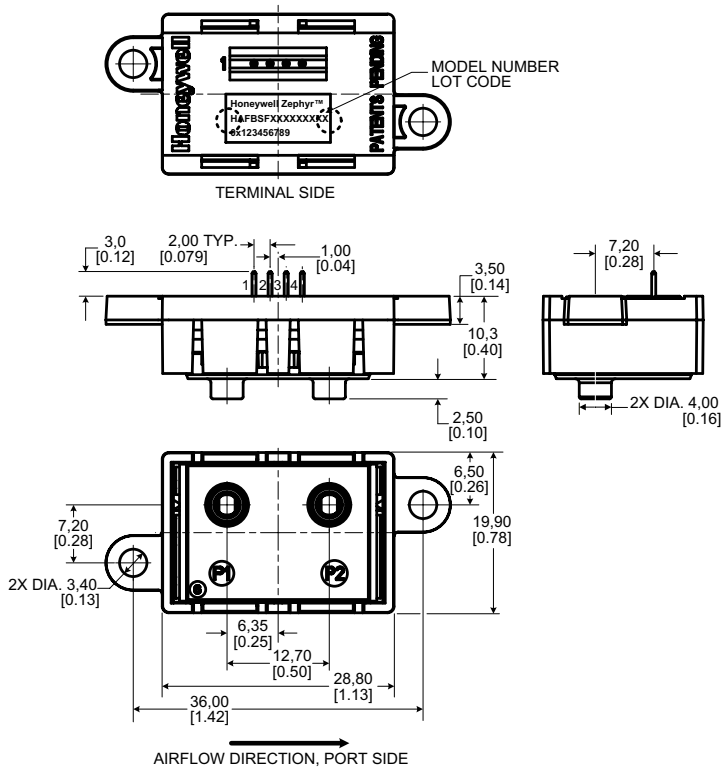

Mounting Footprint

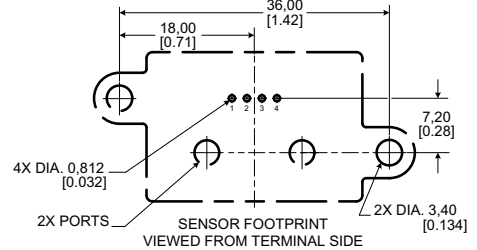

±50 SCCM to ±750 SCCM

Figure 9. Mounting Dimensions (For reference only: mm [in], continued.)

SS: Short port, snap mount



Table 8. Pinout

Pin 1	Pin 2	Pin 3	Pin 4
Vout	Vsupply	ground	NC

ADDITIONAL INFORMATION

The following associated literature is available at sensing.honeywell.com:

- Product line guide
- Product part listing/nomenclature tree
- Product range guide
- Technical Information:
 - Gas Media Compatibility and Correction Factors
- Installation Instructions
- Application specific information

Find out more

Honeywell serves its customers through a worldwide network of sales offices, representatives and distributors. For application assistance, current specifications, pricing or name of the nearest Authorized Distributor, contact your local sales office.

To learn more about Honeywell's sensing and control products, call **+1-815-235-6847** or **1-800-537-6945**, visit **sensing.honeywell.com**, or e-mail inquiries to **info.sc@honeywell.com**

Sensing and Control
Honeywell
1985 Douglas Drive North
Golden Valley, MN 55422
honeywell.com

⚠ WARNING

PERSONAL INJURY

DO NOT USE these products as safety or emergency stop devices or in any other application where failure of the product could result in personal injury.

Failure to comply with these instructions could result in death or serious injury.

⚠ WARNING

MISUSE OF DOCUMENTATION

- The information presented in this product sheet is for reference only. Do not use this document as a product installation guide.
- Complete installation, operation, and maintenance information is provided in the instructions supplied with each product.

Failure to comply with these instructions could result in death or serious injury.

WARRANTY/REMEDY

Honeywell warrants goods of its manufacture as being free of defective materials and faulty workmanship. Honeywell's standard product warranty applies unless agreed to otherwise by Honeywell in writing; please refer to your order acknowledgement or consult your local sales office for specific warranty details. If warranted goods are returned to Honeywell during the period of coverage, Honeywell will repair or replace, at its option, without charge those items it finds defective. **The foregoing is buyer's sole remedy and is in lieu of all other warranties, expressed or implied, including those of merchantability and fitness for a particular purpose. In no event shall Honeywell be liable for consequential, special, or indirect damages.**

While we provide application assistance personally, through our literature and the Honeywell website, it is up to the customer to determine the suitability of the product in the application.

Specifications may change without notice. The information we supply is believed to be accurate and reliable as of this issue; however, we assume no responsibility for its use.

Honeywell



Компания «ЭлектроПласт» предлагает заключение долгосрочных отношений при поставках импортных электронных компонентов на взаимовыгодных условиях!

Наши преимущества:

- Оперативные поставки широкого спектра электронных компонентов отечественного и импортного производства напрямую от производителей и с крупнейших мировых складов;
- Поставка более 17-ти миллионов наименований электронных компонентов;
- Поставка сложных, дефицитных, либо снятых с производства позиций;
- Оперативные сроки поставки под заказ (от 5 рабочих дней);
- Экспресс доставка в любую точку России;
- Техническая поддержка проекта, помощь в подборе аналогов, поставка прототипов;
- Система менеджмента качества сертифицирована по Международному стандарту ISO 9001;
- Лицензия ФСБ на осуществление работ с использованием сведений, составляющих государственную тайну;
- Поставка специализированных компонентов (Xilinx, Altera, Analog Devices, Intersil, Interpoint, Microsemi, Aeroflex, Peregrine, Syfer, Eurofarad, Texas Instrument, Miteq, Cobham, E2V, MA-COM, Hittite, Mini-Circuits, General Dynamics и др.);

Помимо этого, одним из направлений компании «ЭлектроПласт» является направление «Источники питания». Мы предлагаем Вам помощь Конструкторского отдела:

- Подбор оптимального решения, техническое обоснование при выборе компонента;
- Подбор аналогов;
- Консультации по применению компонента;
- Поставка образцов и прототипов;
- Техническая поддержка проекта;
- Защита от снятия компонента с производства.



Как с нами связаться

Телефон: 8 (812) 309 58 32 (многоканальный)

Факс: 8 (812) 320-02-42

Электронная почта: org@eplast1.ru

Адрес: 198099, г. Санкт-Петербург, ул. Калинина, дом 2, корпус 4, литера А.