

# EMH-54/3-Q48N-C Series

Isolated, 54Vout, 3A, Ethernet Power  
Half-Brick DC/DC Converters

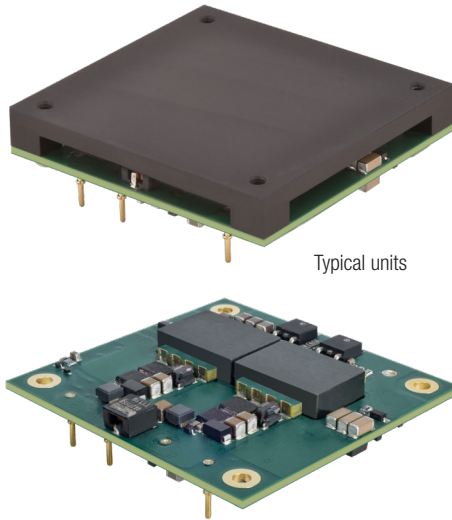

Typical units

## FEATURES

- Industry-Standard “Half-Brick” footprint
- 162W output power @ 24-72Vin
- Up to 91.5% Efficiency at 54V output (typical)
- On/Off Control (Negative logic)
- Monotonic startup into pre-bias output conditions
- Over-current, Output & Over-temperature protection
- Low output ripple and noise
- Strong thermal derating characteristics
- Operational Temperature Range -40°C to +85°C with baseplate
- 2250V I/O isolation
- Output short-circuit protection (hiccup technique)

## PRODUCT OVERVIEW

The EMH-54/3-Q48N-C module offers 54V output at 3 amps in a Half Brick footprint DC/DC power converter. These compact modules measure 2.4” x 2.3” x 0.5” (61 x 58.4 x 12.7 mm) with baseplate and offer the industry-standard Half-Brick footprint. The product is designed to fully comply with RoHS-6 directive.

## ORDERING GUIDE SUMMARY

Model	Vout Range	Iout Range	Vin Range	Ripple/Noise	Efficiency
EMH-54/3-Q48	54V	0.2-3A	18-72V	250mVp-p	91.5%

## INPUT CHARACTERISTICS

Parameter	Typ. @ 25°C, full load	Notes
<b>Voltage Range</b>	18-72 Volts	48V nominal
<b>Input Current, full power</b>	3.67 Amps	VIN = 48V
<b>Turn On/start-up threshold</b>	17.5 Volts	
<b>Undervoltage Shutdown</b>	17 Volts	
<b>No load Input Current</b>	40mA	VIN = 48V

## OUTPUT CHARACTERISTICS

Parameter	Typ. @ 25°C, full load	Notes
<b>Voltage</b>	54 Volts	±2%
<b>Current</b>	0.2 to 3 Amps	0.2A min load required
<b>Power Output</b>	162 Watts	
<b>Ripple &amp; Noise</b>	250mVp-p	20MHz bandwidth
<b>Line and Load Regulation</b>	±0.125%/±0.2%	
<b>Overcurrent Protection</b>	4 Amps	With hiccup auto-restart
<b>Overtemperature Protection</b>	+135°C	
<b>Efficiency (minimum)</b>	89.5%	
<b>Efficiency (typical)</b>	91.5%	

## GENERAL SPECIFICATIONS

Parameter	Typ. @ 25°C, full load	Notes
<b>Dynamic Load Response</b>	300µsec	50-75-50% step to ±1 of final value
<b>Operating Temperature Range</b>	-40 to +85°C	With baseplate, see derating curve
<b>Absolute Operating Temperature Range</b>	-40 to +105°C	Measured at Thermistor, see derating
<b>Safety Features</b>	UL 60950-1, 2nd edition	
	CSA-C22.2 No.60950-1 and IEC/EN60950-1	

## PHYSICAL SPECIFICATIONS

Parameter	Inches	Millimeters
<b>Open frame (no baseplate)</b>	2.4 x 2.3 x 0.43	61 x 58.4 x 10.92
<b>With baseplate</b>	2.4 x 2.3 x 0.5	61.0 x 58.4 x 12.7

The modules offer wide range input voltage of 18-72V. The EMH topology offers high efficiency up to 91.5%, good regulation, low ripple/noise, and a fast dynamic load response. The module supplies up to 162 Watts of power and isolation rated at 2250V for basic insulation. EMH models are designed for

demanding telecom, POE (power over Ethernet), data-com, and networking applications. EMHs feature input filters, input under voltage, output current limiting, short-circuit protection, and thermal shutdown.



For full details go to  
[www.murata-ps.com/rohs](http://www.murata-ps.com/rohs)

PERFORMANCE SPECIFICATIONS SUMMARY AND ORDERING GUIDE														
Root Model ①	Output						Input				Efficiency		Dimensions with baseplate (Inches)	
	V <sub>OUT</sub> (Volts)	I <sub>OUT</sub> (Amps, Max.)	Power (Watts)	R/N (mV pk-pk)		Regulation (Max.)		V <sub>IN</sub> Nom. (Volts)	Range (Volts)	I <sub>IN</sub> , no load (mA)	I <sub>IN</sub> , full load (Amps)	Min.		Typ.
				Typ.	Max.	Line	Load							
EMH-54/3-Q48	54	3	162	250	350	±0.125%	±0.2%	48	18-72	40	3.67	89.5%	91.5%	2.4x2.3x0.5

① Please refer to the full part number structure for additional ordering part numbers and options.

② All specifications are typical at nominal line voltage and full load, +25°C, unless otherwise noted. Units are tested with a 1µF ceramic external output capacitor and a 100µF and 2.2µF external input capacitor.

③ Full power continuous output requires baseplate installation. Please refer to the derating curves.

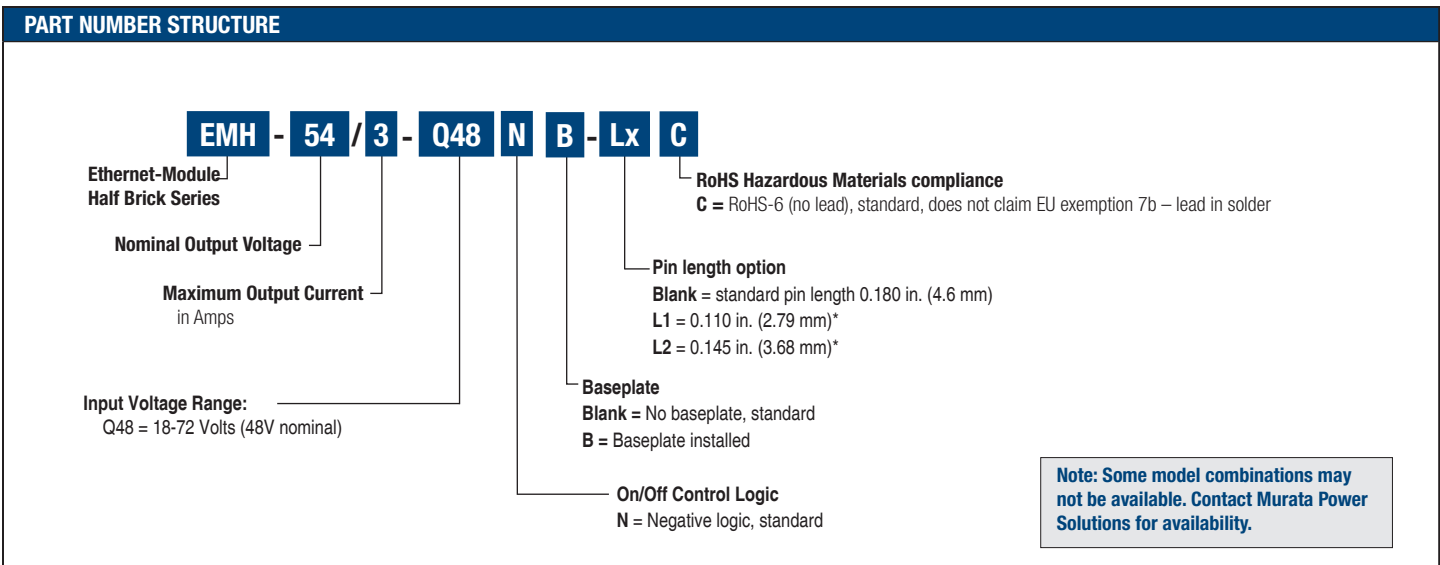

## FUNCTIONAL SPECIFICATIONS

ABSOLUTE MAXIMUM RATINGS	Conditions ①	Minimum	Typical/Nominal	Maximum	Units
Input Voltage, Continuous	Full power operation	0		72	Vdc
Isolation Voltage	Input to output tested			2250	Vdc
Input Reverse Polarity	None, install external fuse		None		Vdc
On/Off Remote Control	Power on or off, referred to -Vin	0		15	Vdc
Output Power		0		164.32	W
Output Current	Current-limited, no damage, short-circuit protected	0.2		3	A
Storage Temperature Range	Vin = Zero (no power)	-55		125	°C

Absolute maximums are stress ratings. Exposure of devices to greater than any of these conditions may adversely affect long-term reliability. Proper operation under conditions other than those listed in the Performance/Functional Specifications Table is not implied nor recommended.

INPUT					
Operating voltage range ②		18	48	72	Vdc
Turn On/Start-up threshold	Rising input voltage	16.5	17.5	18	Vdc
Ambient temperature > 60°C				19	Vdc
Turn Off/Undervoltage lockout	Tested at 2.6A	15	17	17.5	Vdc
Turn-On/Turn-Off Hysteresis		1.0	1.05	1.2	Vdc
Reverse Polarity Protection	None, install external fuse		None		Vdc
Recommended External Fuse	Fast blow		20		A
Internal Filter Type			L-C		
Input current					
Full Load Conditions	Vin = nominal		3.67	3.83	A
Low line input current	Vin @ Min. @2.6A		8.52	8.84	A
Inrush Transient			0.1		A <sup>2</sup> -Sec.
Short Circuit Input Current			250	350	mA
No Load Input Current	Iout = minimum, unit=ON		40	80	mA
Shutdown Mode Input Current (Off, UV, OT)			5	10	mA
Reflected (back) ripple current ③	Measured at input with specified filter		40	80	mA, p-p

GENERAL and SAFETY					
Efficiency	Vin = 48V, full load	89.5	91.5		%
	Vin = 24V, full load	89.5	91.5		%
	Vin = 18V, full load	89.5	91		%
Isolation					
Isolation Voltage: no baseplate	Input to output, continuous	2250			Vdc
	Input to output, continuous	2250			Vdc
Isolation Voltage: with baseplate	Input to Baseplate, continuous	1500			
	Output to Baseplate, continuous	750			
Insulation Safety Rating			basic		
Isolation Resistance			100		Mohm
Isolation Capacitance			5,000		pF
Safety (Designed to meet the following requirements)	UL-60950-1, CSA-C22.2 No.60950-1, IEC/EN60950-1, 2nd Edition		Yes		
Calculated MTBF	Per Telcordia SR332, issue 1 class 3, ground fixed, Tambient=+25°C		1.8+		Hours x 10 <sup>6</sup>

DYNAMIC CHARACTERISTICS					
Fixed Switching Frequency		387	430	473	KHz
Startup Time	Power On to Vout regulated 10-90% (50% resistive load)		40	60	mS
	Remote ON to 10% Vout (50% resistive load)		30	50	mS
Dynamic Load Response	50-75-50% load step, settling time to within ±2% of Vout		300	450	µSec
Dynamic Load Peak Deviation	same as above		±1000	±1250	mV

FEATURES and OPTIONS					
Remote On/Off Control ④					
"N" suffix:					
Negative Logic, ON state	ON = Pin grounded or external voltage	-0.7		0.8	V
Negative Logic, OFF state	OFF = Pin open or external voltage	5		15	V
Control Current	open collector/drain		1	2	mA
Base Plate	"B" suffix				

## FUNCTIONAL SPECIFICATIONS (CONT.)

OUTPUT					
<b>Total Output Power</b>	See Derating	0.0	161.1	164.32	W
<b>Voltage</b>					
<b>Nominal Output Voltage</b>	No trim	52.626	53.7	54.774	Vdc
<b>Setting Accuracy</b>	At 50% load	-2		2	% of Vnom.
<b>Output Voltage Range</b>	User-adjustable ⑥		N/A		% of Vnom.
<b>Overvoltage Protection</b>	Via magnetic feedback		65	67	Vdc
<b>Current</b>					
<b>Output Current Range: 24-72 Vin</b>		0.2	3	3	A
<b>Output Current Range: 18-24 Vin</b>		0.2	2.6	2.6	A
<b>Minimum Load</b>			0.2		
<b>Current Limit Inception ⑤</b>	98% of Vnom., after warmup	3.2	3.9	4.7	A
<b>Short Circuit</b>					
<b>Short Circuit Current</b>	Hiccup technique, autorecovery within ±1% of Vout, non-latching		0.5	1	A
<b>Short Circuit Duration (remove short for recovery)</b>	Output shorted to ground, no damage		Continuous		
<b>Short circuit protection method</b>	Current limiting				
<b>Regulation ③</b>					
<b>Line Regulation</b>	Vin=min. to max. Vout=nom., 50% load			±0.125	%
<b>Load Regulation</b>	Iout=min. to max. Vin=48V.			±0.2	%
<b>Ripple and Noise</b>	5 Hz- 20 MHz BW		250	350	mV pk-pk
<b>Temperature Coefficient</b>	At all outputs		0.02		% of Vnom./°C
<b>Maximum Capacitive Loading</b>	Low ESR, resistive load	0		3300	µF
<b>MECHANICAL (Through Hole Models)</b>					
<b>Outline Dimensions (open frame)</b>			2.4 x 2.3 x 0.43		Inches
			61.0 x 58.4 x 10.92		mm
<b>Outline Dimensions (with baseplate)</b>			2.4 X 2.3 X 0.5		Inches
	LxWxH (Please refer to outline drawing)		61.0 x 58.4 x 12.7		mm
<b>Weight (with baseplate)</b>			2.3		Ounces
			67.13		Grams
<b>Through Hole Pin Diameter</b>	See mechanical drawing		0.04 & 0.080		Inches
			1.016 & 2.032		mm
<b>Through Hole Pin Material</b>			Copper alloy		
<b>TH Pin Plating Metal and Thickness</b>	Nickel subplate		50		µ-inches
	Gold overplate		5		µ-inches
<b>Case or Baseplate Material</b>			Aluminum		
<b>ENVIRONMENTAL</b>					
<b>Operating Ambient Temperature Range</b>	With derating	-40		85	°C
<b>Operating Ambient Temperature Range with Baseplate</b>	Maximum baseplate temperature: Converter delivers full rated power at max baseplate temp.	-40		100	°C
<b>Absolute Operating Temperature Range</b>	Measured @ Thermistor or in the middle of baseplate	-40		105	°C
<b>Storage Temperature</b>	Vin = Zero (no power)	-40		125	°C
<b>Thermal Protection/Shutdown</b>		125	135	140	°C
<b>Electromagnetic Interference Conducted, EN55022/CISPR22</b>	External filter required		B		Class
<b>Radiated, EN55022/CISPR22</b>			B		Class
<b>RoHS rating</b>			RoHS-6		

### Notes

- ① Unless otherwise noted, all specifications are at nominal input voltage, nominal output voltage and full load. General conditions are +25° Celsius ambient temperature, near sea level altitude, natural convection airflow. All models are tested and specified with an external 1 µF multi-layer ceramic output capacitor. The external input capacitors are 100µF and 2.2µF ceramic. All capacitors are low-ESR types wired close to the converter. These capacitors are necessary for our test equipment and may not be needed in the user's application.
- ② The module will operate when input voltage is within the 18-72V Operating Voltage Range. Output regulation at full load will be achieved only when Vin ≥ 18V.
- ③ Input (back) ripple current is tested and specified over 5 Hz to 20 MHz bandwidth. Input filtering is Cbus = 220 µF, Cin = 33 µF and Lbus = 12 µF.
- ④ The Remote On/Off Control is referred to -Vin.
- ⑤ Over-current protection is non-latching with auto recovery (Hiccup)
- ⑥ Regulation specifications describe the output voltage changes as the line voltage or load current is varied from its nominal or midpoint value to either extreme.

**TYPICAL PERFORMANCE DATA**

Maximum Current Temperature Derating vs. Airflow  
(Vin = 18, airflow from Pin 1 to Pin 4 on PCB, no Baseplate)

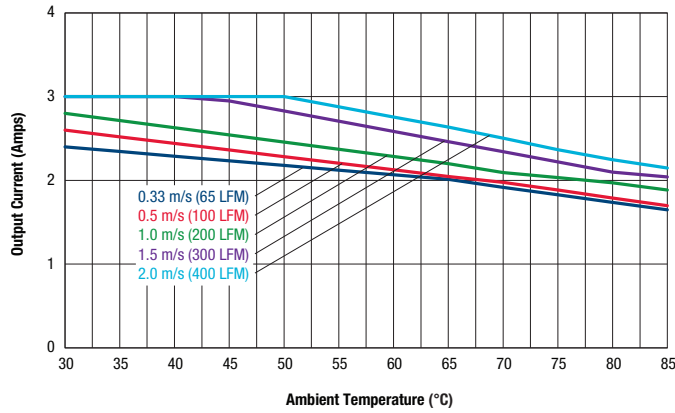

Maximum Current Temperature Derating vs. Airflow  
(Vin = 24V, airflow from from Pin 1 to Pin 4 on PCB, no Baseplate)

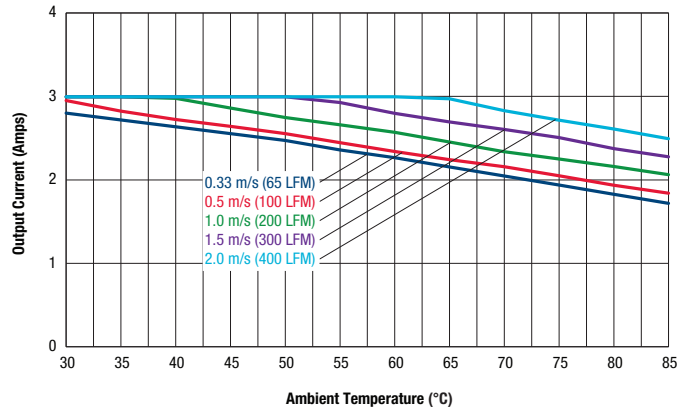

Maximum Current Temperature Derating vs. Airflow  
(Vin = 36, airflow from Pin 1 to Pin 4 on PCB, no Baseplate)

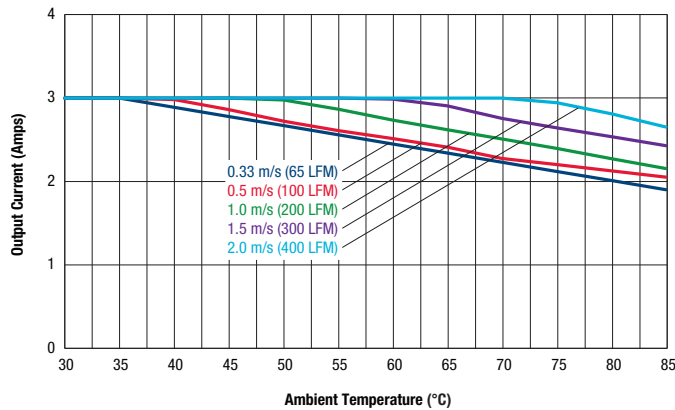

Maximum Current Temperature Derating vs. Airflow  
(Vin = 48V, airflow from from Pin 1 to Pin 4 on PCB, no Baseplate)

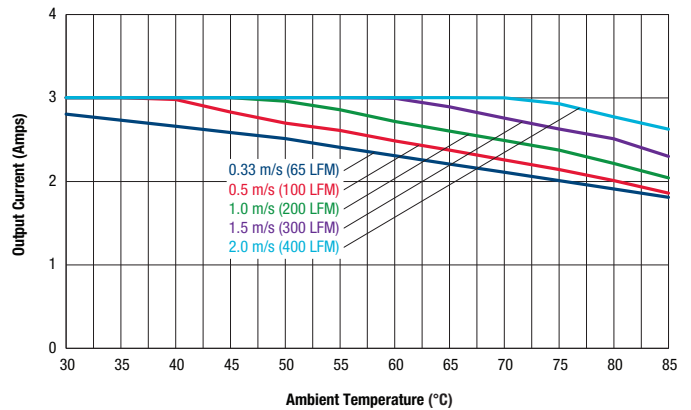

Maximum Current Temperature Derating vs. Airflow  
(Vin = 60, airflow from Pin 1 to Pin 4 on PCB, no Baseplate)

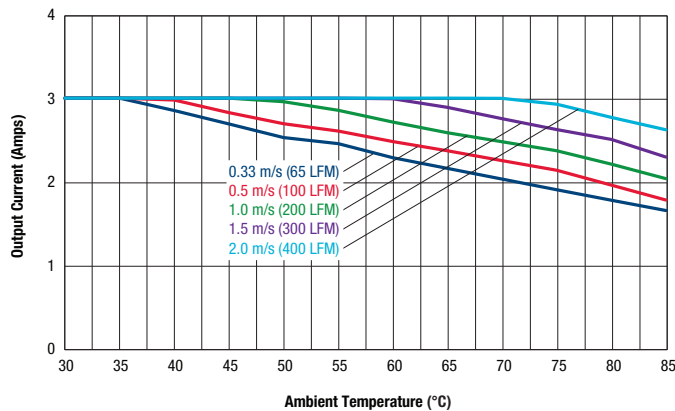

Maximum Current Temperature Derating vs. Airflow  
(Vin = 72V, airflow from from Pin 1 to Pin 4 on PCB, no Baseplate)

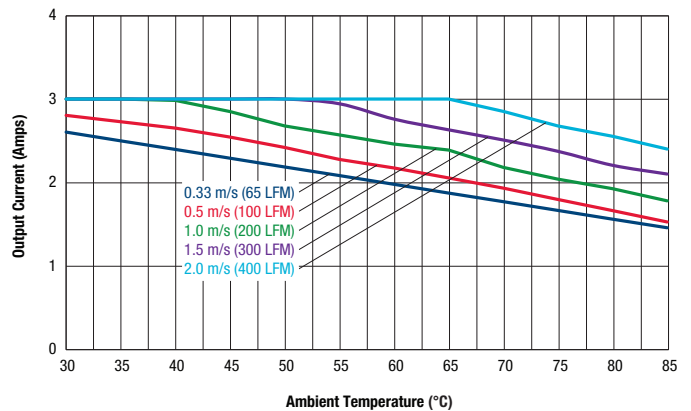

## TYPICAL PERFORMANCE DATA

Maximum Current Temperature Derating vs. Airflow  
(Vin = 18, airflow from Pin 1 to Pin 4 on PCB, with Baseplate)

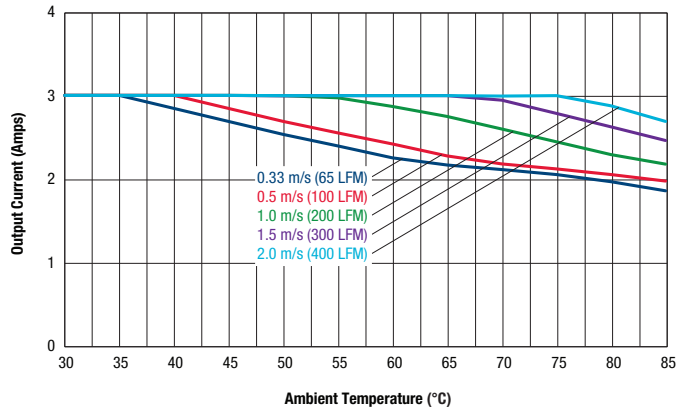

Maximum Current Temperature Derating vs. Airflow  
(Vin = 24V, airflow from from Pin 1 to Pin 4 on PCB, with baseplate)

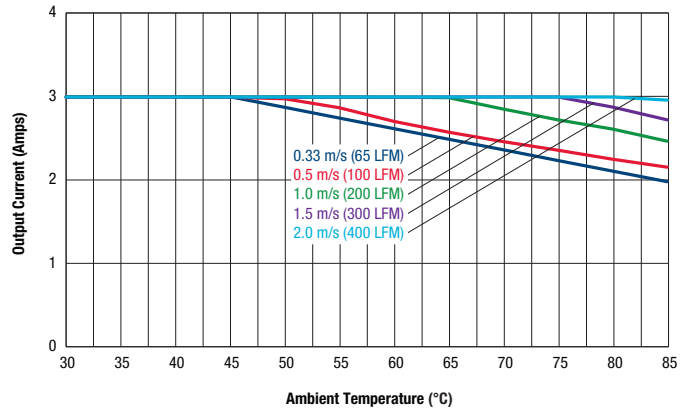

Maximum Current Temperature Derating vs. Airflow  
(Vin = 36, airflow from Pin 1 to Pin 4 on PCB, with Baseplate)

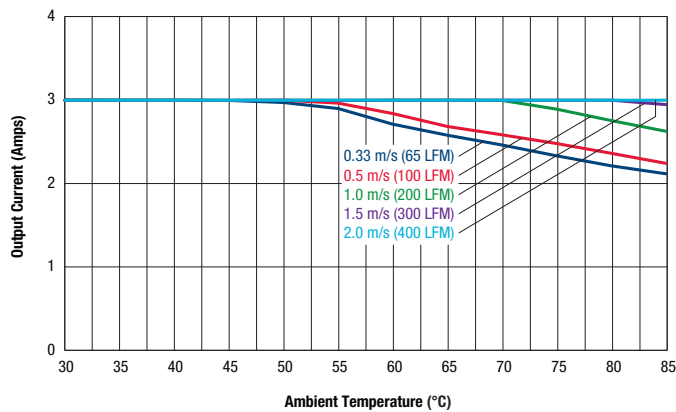

Maximum Current Temperature Derating vs. Airflow  
(Vin = 48V, airflow from from Pin 1 to Pin 4 on PCB, with baseplate)

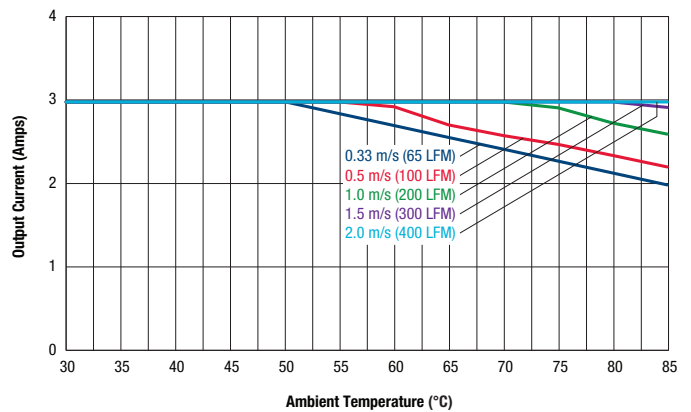

Maximum Current Temperature Derating vs. Airflow  
(Vin = 60, airflow from Pin 1 to Pin 4 on PCB, with Baseplate)

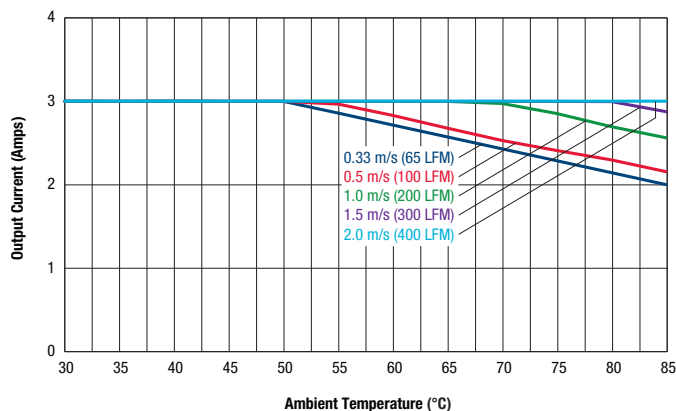

Maximum Current Temperature Derating vs. Airflow  
(Vin = 72V, airflow from from Pin 1 to Pin 4 on PCB, with baseplate)

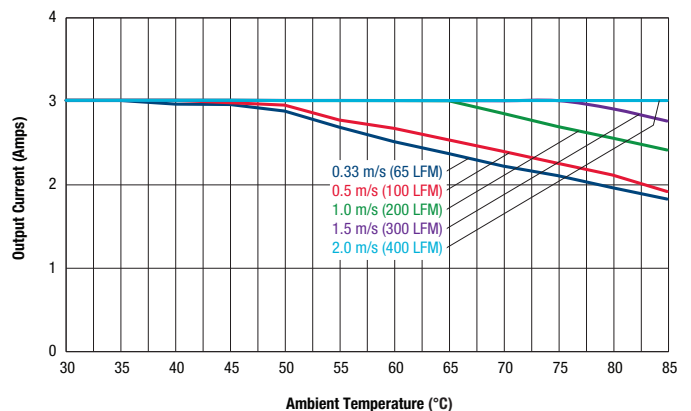

## TYPICAL PERFORMANCE DATA

Efficiency vs Line Voltage and Load Current @ +25°C

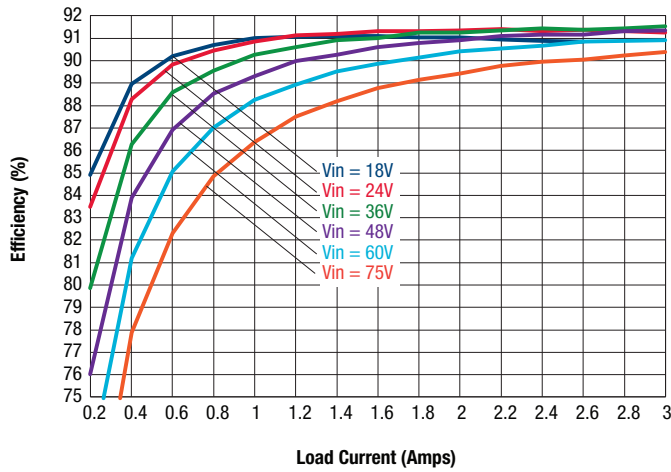

Startup Delay (Vin=48V, Iout=3A, Ta=+25°C) Trace 1=Vin, Trace 4=Vout.

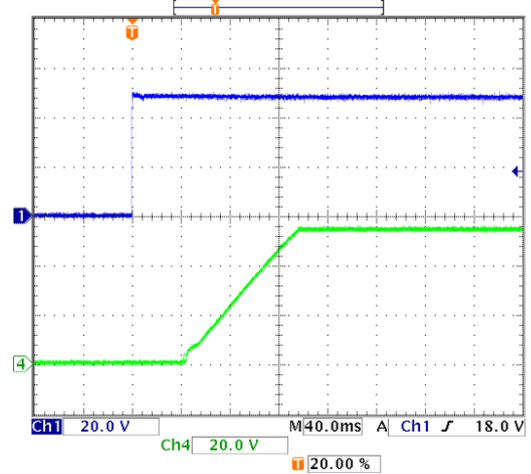

On/Off Enable Delay (Vin=48V, Iout=3A, Ta=+25°C) Trace 1=Enable, Trace 4=Vout.

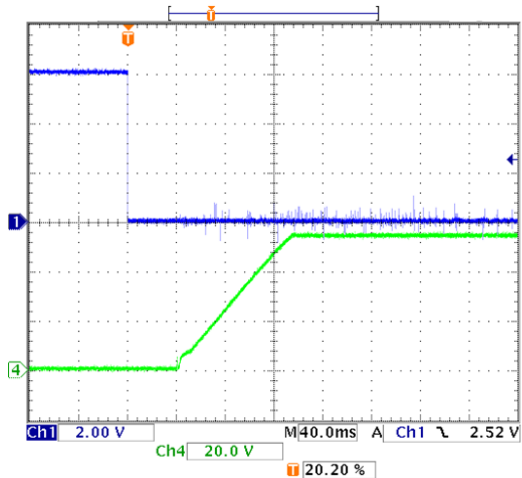

Stepload Transient Response (Vin=48V, Iout=50-75-50%, Ta=+25°C)

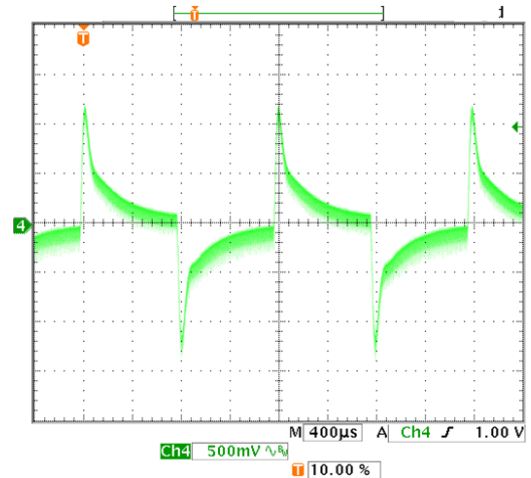

Output Ripple and Noise (Vin=48V, Vout=nom, Iout=0A, Cload=1µF, Ta=+25°C)

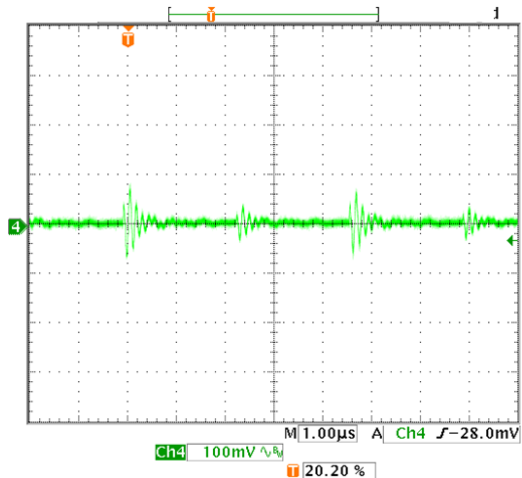

Output Ripple and Noise (Vin=48V, Vout=nom, Iout=3A, Cload=1µF, Ta=+25°C)

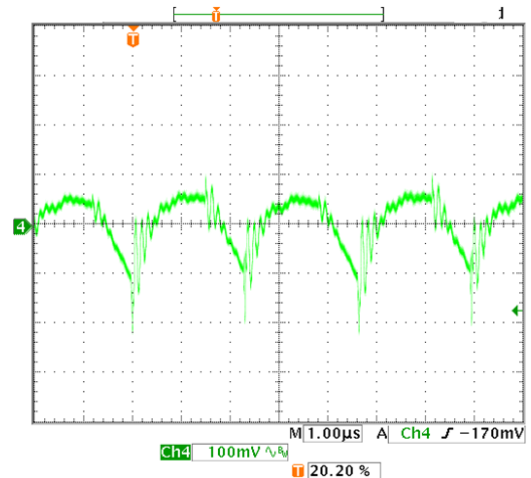

**TYPICAL PERFORMANCE DATA**

Thermal image with hot spot at 2.9A with 25°C ambient temperature. Natural convection is used with no forced airflow. Identifiable and recommended maximum value to be verified in application. Vin=48V, T3 and Q12 max temp=128°C/IPC9592 guidelines.

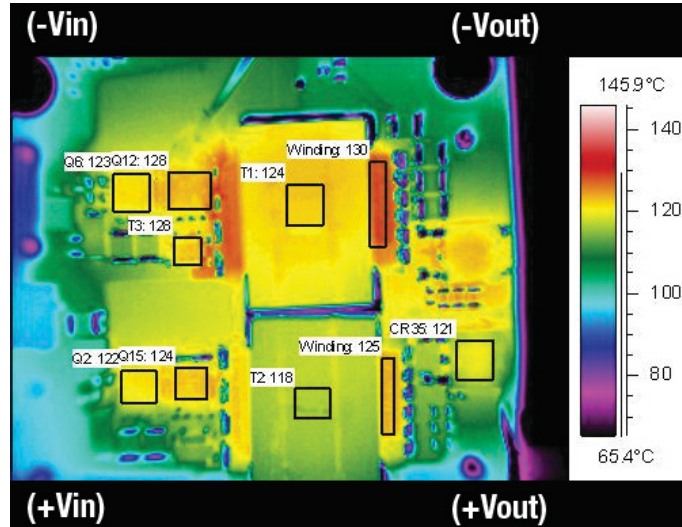



**MECHANICAL SPECIFICATIONS – OPEN FRAME**

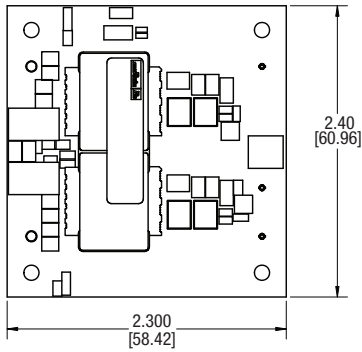

TOP VIEW

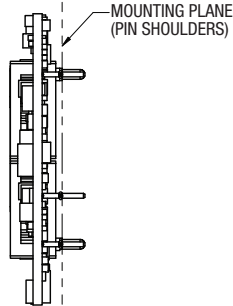

SIDE VIEW

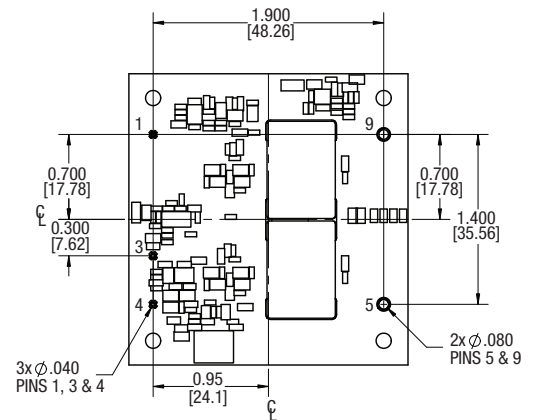

BOTTOM VIEW

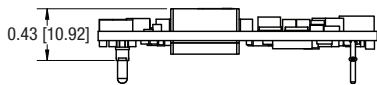

END VIEW

Dimensions are in inches (mm shown for ref. only).

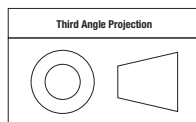

Tolerances (unless otherwise specified):  
 .XX ± 0.02 (0.5)  
 .XXX ± 0.010 (0.25)  
 Angles ± 2°

Components are shown for reference only.

**INPUT/OUTPUT CONNECTIONS**

Pin	Function
1	Negative Input
2	Omitted
3	Remote On/Off
4	Positive Input
5	Positive Output
6	Omitted
7	Omitted
8	Omitted
9	Negative Output

MATERIAL:

FINISH: (ALL PINS)

.080 PINS: COPPER ALLOY

.040 PINS: COPPER ALLOY

FINISH: (ALL PINS)

GOLD (5u"MIN) OVER NICKEL (50u" MIN)

## MECHANICAL SPECIFICATIONS – WITH BASEPLATE

Dimensions are in inches (mm shown for ref. only).

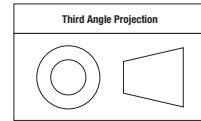

Tolerances (unless otherwise specified):  
 .XX ± 0.02 (0.5)  
 .XXX ± 0.010 (0.25)  
 Angles ± 2°

Components are shown for reference only.

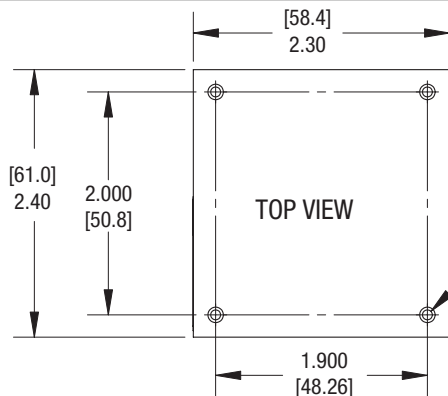

0.112-40-UNC-2B  
0.25 MIN DEEP (4 PLS)

END VIEW

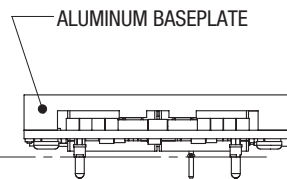
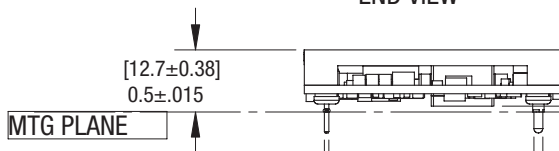

SIDE VIEW

∅ 0.071 ± 0.002 VENTED  
SHOULDER AT EACH  
∅ 0.040 ± 0.002  
(PINS 1, 3-4)

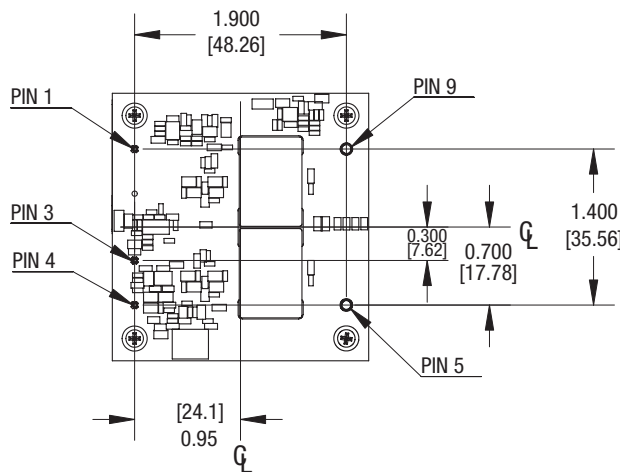

BOTTOM VIEW

### INPUT/OUTPUT CONNECTIONS

Pin	Function
1	Negative Input
2	Omitted
3	Remote On/Off
4	Positive Input
5	Positive Output
6	Omitted
7	Omitted
8	Omitted
9	Negative Output

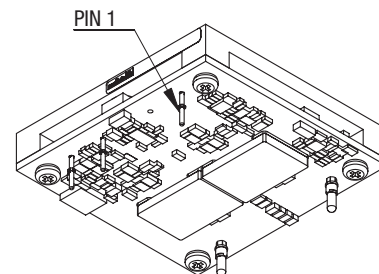

ISOMETRIC VIEW

**MATERIAL:**

- ∅ .040 PINS: COPPER ALLOY
- ∅ .080 PINS: COPPER ALLOY

**FINISH: (ALL PINS)**

GOLD (5u"MIN) OVER NICKEL (50u" MIN)

## RECOMMENDED FOOTPRINT (VIEW THROUGH CONVERTER)

### TOP VIEW

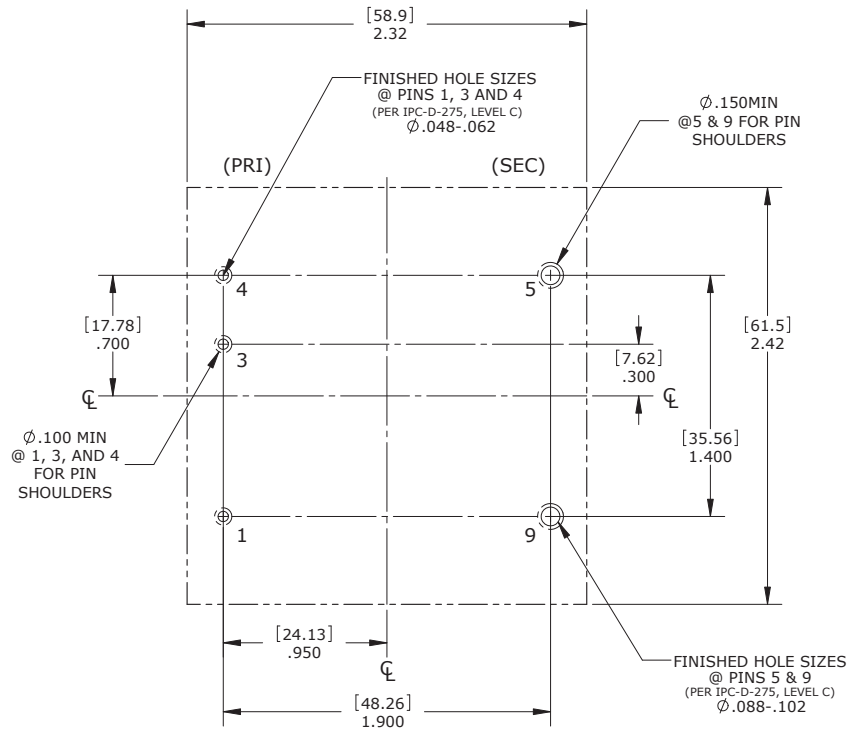

IT IS RECOMMENDED THAT NO PARTS  
BE PLACED BENEATH CONVERTER

Dimensions are in inches (mm shown for ref. only).

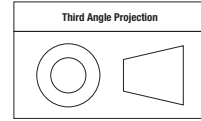

Tolerances (unless otherwise specified):  
XX  $\pm 0.02$  (0.5)  
.XXX  $\pm 0.010$  (0.25)  
Angles  $\pm 2^\circ$

Components are shown for reference only.

## STANDARD PACKAGING

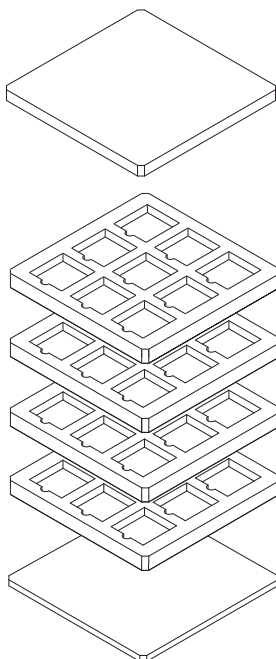

Each static dissipative  
polyethylene foam tray  
accommodates 9 converters  
in a 3 x 3 array

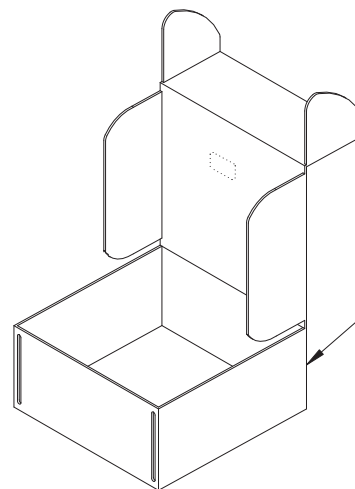

Carton inside dimensions:  
10" x 10" x 4.25"  
(4 trays of 9)

**TECHNICAL NOTES**

### Input Fusing

Certain applications and/or safety agencies may require fuses at the inputs of power conversion components. Fuses should also be used when there is the possibility of sustained input voltage reversal which is not current-limited. For greatest safety, we recommend a fast blow fuse installed in the ungrounded input supply line.

The installer must observe all relevant safety standards and regulations. For safety agency approvals, install the converter in compliance with the end-user safety standard, i.e. IEC/EN/UL 60950-1.

### Input Reverse-Polarity Protection

If the input voltage polarity is reversed, an internal diode will become forward biased and likely draw excessive current from the power source. If this source is not current-limited or the circuit appropriately fused, it could cause permanent damage to the converter.

### Input Under-Voltage Shutdown and Start-Up Threshold

Under normal start-up conditions, converters will not begin to regulate properly until the ramping-up input voltage exceeds and remains at the Start-Up Threshold Voltage (see Specifications). Once operating, converters will not turn off until the input voltage drops below the Under-Voltage Shutdown Limit. Subsequent restart will not occur until the input voltage rises again above the Start-Up Threshold. This built-in hysteresis prevents any unstable on/off operation at a single input voltage.

Users should be aware however of input sources near the Under-Voltage Shutdown whose voltage decays as input current is consumed (such as capacitor inputs), the converter shuts off and then restarts as the external capacitor recharges. Such situations could oscillate. To prevent this, make sure the operating input voltage is well above the UV Shutdown voltage AT ALL TIMES.

### Start-Up Time

Assuming that the output current is set at the rated maximum, the Vin to Vout Start-Up Time (see Specifications) is the time interval between the point when the ramping input voltage crosses the Start-Up Threshold and the fully loaded regulated output voltage enters and remains within its specified accuracy band. Actual measured times will vary with input source impedance, external input capacitance, input voltage slew rate and final value of the input voltage as it appears at the converter.

These converters include a soft start circuit, which limits the duty cycle of the PWM controller at power up, thereby limiting the input inrush current.

The On/Off Remote Control interval from On command to Vout regulated assumes that the converter already has its input voltage stabilized above the Start-Up Threshold before the On command. The interval is measured from the On command until the output enters and remains within its specified accuracy band. The specification assumes that the output is fully loaded at maximum rated current. Similar conditions apply to the On to Vout regulated specification such as external load capacitance and soft start circuitry.

### Input Source Impedance

These converters will operate to specifications without external components, assuming that the source voltage has very low impedance and reasonable input voltage regulation. Since real-world voltage sources have finite impedance, performance is improved by adding external filter components. Sometimes only a small ceramic capacitor is sufficient. Since it is difficult to totally characterize

all applications, some experimentation may be needed. Note that external input capacitors must accept high speed switching currents.

Because of the switching nature of DC/DC converters, the input of these converters must be driven from a source with both low AC impedance and adequate DC input regulation. Performance will degrade with increasing input inductance. Excessive input inductance may inhibit operation. The DC input regulation specifies that the input voltage, once operating, must never degrade below the Shut-Down Threshold under all load conditions. Be sure to use adequate trace sizes and mount components close to the converter.

### I/O Filtering, Input Ripple Current and Output Noise

All models in this converter series are tested and specified for input reflected ripple current and output noise using designated external input/output components, circuits and layout as shown in the figures below. External input capacitors (Cin in the figure) serve primarily as energy storage elements, minimizing line voltage variations caused by transient IR drops in the input conductors. Users should select input capacitors for bulk capacitance (at appropriate frequencies), low ESR and high RMS ripple current ratings. In the figure below, the Cbus and Lbus components simulate a typical DC voltage bus. Your specific system configuration may require additional considerations. Please note that the values of Cin, Lbus and Cbus will vary according to the specific converter model.

In critical applications, output ripple and noise (also referred to as periodic and

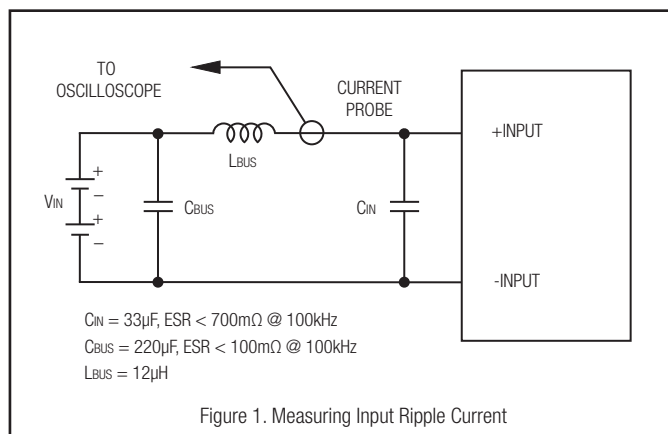

random deviations or PARD) may be reduced by adding filter elements such as multiple external capacitors. Be sure to calculate component temperature rise from reflected AC current dissipated inside capacitor ESR. Our Application Engineers can recommend potential solutions.

### Floating Outputs

Since these are isolated DC/DC converters, their outputs are “floating” with respect to their input. The essential feature of such isolation is ideal ZERO CURRENT FLOW between input and output. Real-world converters however do exhibit tiny leakage currents between input and output (see Specifications). These leakages consist of both an AC stray capacitance coupling component and a DC leakage resistance. When using the isolation feature, do not allow the isolation voltage to exceed specifications. Otherwise the converter may be damaged. Designers will normally use the negative output (-Output) as the ground return of the load circuit. You can however use the positive output (+Output) as the ground return to effectively reverse the output polarity.

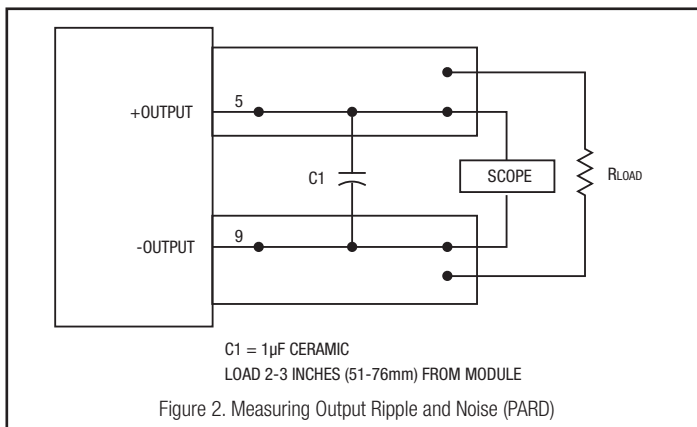

### Thermal Shutdown

To prevent many over temperature problems and damage, these converters include thermal shutdown circuitry. If environmental conditions cause the temperature of the DC/DC's to rise above the Operating Temperature Range up to the shutdown temperature, an on-board electronic temperature sensor will power down the unit. When the temperature decreases below the turn-on threshold, the converter will automatically restart. There is a small amount of hysteresis to prevent rapid on/off cycling. The temperature sensor is typically located adjacent to the switching controller, approximately in the center of the unit. See the Performance and Functional Specifications.

**CAUTION:** If you operate too close to the thermal limits, the converter may shut down suddenly without warning. Be sure to thoroughly test your application to avoid unplanned thermal shutdown.

### Temperature Derating Curves

The graphs in this data sheet illustrate typical operation under a variety of conditions. The derating curves show the maximum continuous ambient air temperature and decreasing maximum output current which is acceptable under increasing forced airflow measured in Linear Feet per Minute ("LFM"). Note that these are AVERAGE measurements. The converter will accept brief increases in temperature and/or current or reduced airflow as long as the average is not exceeded.

Note that the temperatures are of the ambient airflow, not the converter itself which is obviously running at higher temperature than the outside air. Also note that very low flow rates are similar to "natural convection," that is, not using fan-forced airflow.

Murata Power Solutions makes characterization measurements in a closed loop wind tunnel with measured airflow. We use both thermocouples and an infrared camera system to observe thermal performance. If in doubt, contact Murata Power Solutions to discuss placement and measurement techniques of suggested temperature sensors.

**CAUTION:** If you routinely or accidentally exceed these Derating guidelines, the converter may have an unplanned Over Temperature shut down. Also, these graphs are all collected at slightly above Sea Level altitude. Be sure to reduce the derating for higher density altitude.

### Output Overvoltage Protection

This converter monitors its output voltage for an over-voltage condition using an on-board electronic comparator. If the output exceeds OVP limits, the sensing circuit will power down the unit, and the output voltage will decrease. After a

time-out period, the PWM will automatically attempt to restart, causing the output voltage to ramp up to its rated value. It is not necessary to power down and reset the converter for this automatic OVP-recovery restart.

If the fault condition persists and the output voltage climbs to excessive levels, the OVP circuitry will initiate another shutdown cycle. This on/off cycling is referred to as "hiccup" mode.

### Output Fusing

The converter is extensively protected against current, voltage and temperature extremes. However your output application circuit may need additional protection. In the extremely unlikely event of output circuit failure, excessive voltage could be applied to your circuit. Consider using an appropriate fuse in series with the output.

### Output Current Limiting

As soon as the output current increases to its maximum rated value, the DC/DC converter will enter a power-limiting mode. The output voltage will decrease proportionally with increases in output current, thereby maintaining a somewhat constant power output. This is commonly referred to as power limiting.

Current limiting inception is defined as the point at which full power falls below the rated tolerance. See the Performance/Functional Specifications. Note particularly that the output current may briefly rise above its rated value. This enhances reliability and continued operation of your application. If the output current is too high, the converter will enter the short circuit condition.

### Output Short Circuit Condition

When a converter is in power-limit mode, the output voltage will drop as the output current demand increases. If the output voltage drops too low, the magnetically coupled voltage used to develop primary side voltages will also drop, thereby shutting down the PWM controller. Following a time-out period, the PWM will restart, causing the output voltage to begin ramping up to its appropriate value. If the short-circuit condition persists, another shutdown cycle will initiate. This on/off cycling is called "hiccup mode". The hiccup cycling reduces the average output current, thereby preventing excessive internal temperatures. A short circuit can be tolerated indefinitely.

### Remote On/Off Control

**Negative:** Optional negative-logic devices are on (enabled) when the On/Off is grounded or brought to within a low voltage (see Specifications) with respect to  $-V_{in}$ . The device is off (disabled) when the On/Off is pulled high to  $+V_{in}$  with respect to  $-V_{in}$ .

Dynamic control of the On/Off function should be able to sink appropriate signal current when brought low and withstand appropriate voltage when brought high. Be aware too that there is a finite time in milliseconds (see Specifications) between the time of On/Off Control activation and stable, regulated output. This time will vary slightly with output load type and current and input conditions.

There are two CAUTIONS for the On/Off Control:

**CAUTION:** While it is possible to control the On/Off with external logic if you carefully observe the voltage levels, the preferred circuit is either an open drain/open collector transistor or a relay (which can thereupon be controlled by logic).

**CAUTION:** Do not apply voltages to the On/Off pin when there is no input voltage. Otherwise the converter may be permanently damaged.

### Power Over Ethernet (PoE)

Power over Ethernet (PoE) supports the implementation of the IEEE 802.3af and IEEE 802.3at standards; this implementation allows both data and electrical power

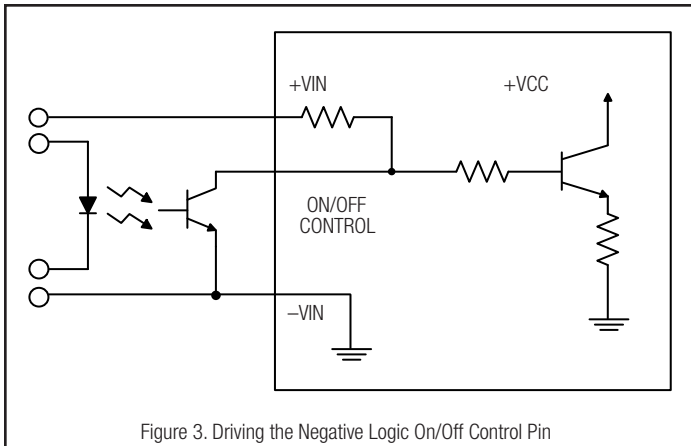

Figure 3. Driving the Negative Logic On/Off Control Pin

### Soldering Guidelines

Murata Power Solutions recommends the specifications below when installing these converters. These specifications vary depending on the solder type. Exceeding these specifications may cause damage to the product. Be cautious when there is high atmospheric humidity. We strongly recommend a mild pre-bake (100° C. for 30 minutes). Your production environment may differ; therefore please thoroughly review these guidelines with your process engineers.

Wave Solder Operations for through-hole mounted products (THMT)			
For Sn/Ag/Cu based solders:		For Sn/Pb based solders:	
Maximum Preheat Temperature	115° C.	Maximum Preheat Temperature	105° C.
Maximum Pot Temperature	270° C.	Maximum Pot Temperature	250° C.
Maximum Solder Dwell Time	7 seconds	Maximum Solder Dwell Time	6 seconds

to pass over a copper Ethernet LAN cable. PoE permits electric power, along with data, to be passed over a copper Ethernet LAN cable. Powered devices, such as voice-over-IP telephones, wireless access points, video cameras, and point-of-sale devices, that support PoE can receive power safely from the access ports that are used to connect personal computers to the network. IEEE 802.3at increases the amount of power to 30W. The PoE standard provides support for legacy PoE devices. An IEEE 802.af powered device can operate normally when connected to IEEE 802.at power sourcing equipment.

Standard	Class	Maximum Power delivered by PoE port	Power range of powered device
IEEE 802.3af (PoE) and IEEE 802.3at (PoE +)	0	15.4 W	0.44 through 12.95 W
	1	4 W	0.44 through 3.84 W
	2	7.0 W	3.84 through 6.49 W
	3	15.4 W	6.49 through 12.95 W
IEEE 802.3at (PoE+)	4	30.0 W	12.95 through 25.5 W

Table 1. Class of Powered Device and Power Levels

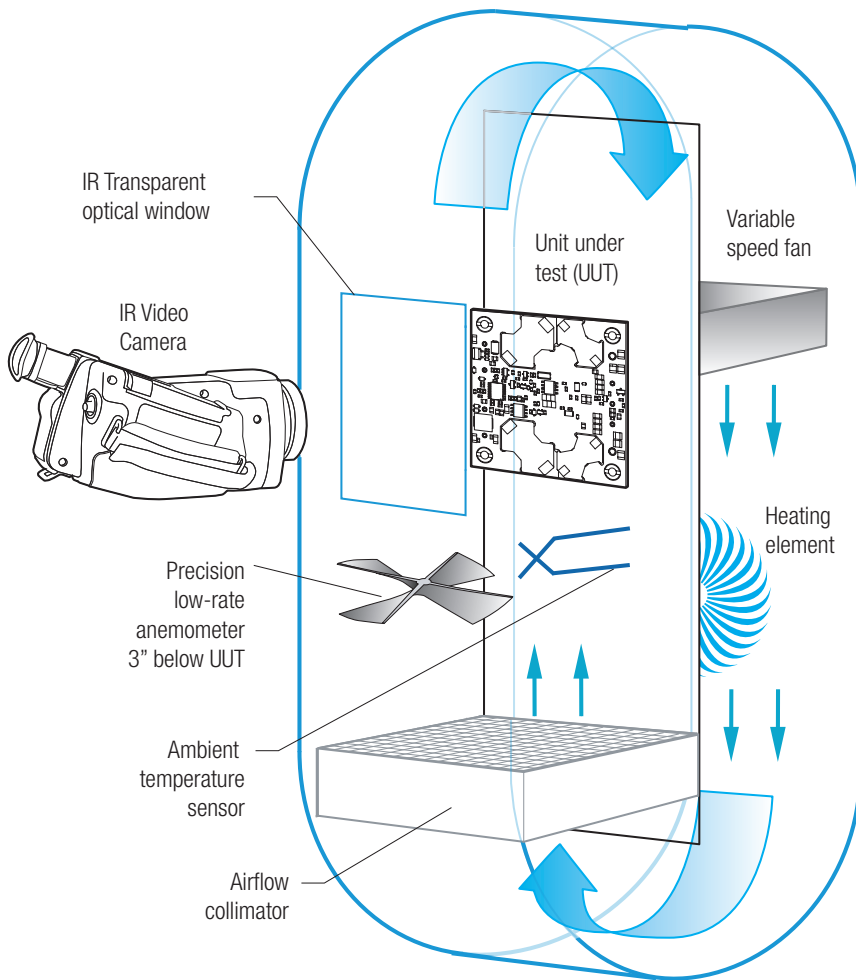

Figure 4. Vertical Wind Tunnel

### Vertical Wind Tunnel

Murata Power Solutions employs a computer controlled custom-designed closed loop vertical wind tunnel, infrared video camera system, and test instrumentation for accurate airflow and heat dissipation analysis of power products. The system includes a precision low flow-rate anemometer, variable speed fan, power supply input and load controls, temperature gauges, and adjustable heating element.

The IR camera monitors the thermal performance of the Unit Under Test (UUT) under static steady-state conditions. A special optical port is used which is transparent to infrared wavelengths.

Both through-hole and surface mount converters are soldered down to a host carrier board for realistic heat absorption and spreading. Both longitudinal and transverse airflow studies are possible by rotation of this carrier board since there are often significant differences in the heat dissipation in the two airflow directions. The combination of adjustable airflow, adjustable ambient heat, and adjustable Input/Output currents and voltages mean that a very wide range of measurement conditions can be studied.

The collimator reduces the amount of turbulence adjacent to the UUT by minimizing airflow turbulence. Such turbulence influences the effective heat transfer characteristics and gives false readings. Excess turbulence removes more heat from some surfaces and less heat from others, possibly causing uneven overheating.

Both sides of the UUT are studied since there are different thermal gradients on each side. The adjustable heating element and fan, built-in temperature gauges, and no-contact IR camera mean that power supplies are tested in real-world conditions.



# Mouser Electronics

Authorized Distributor

Click to View Pricing, Inventory, Delivery & Lifecycle Information:

[Murata:](#)

[EMH-54/3-Q48NB-C](#) [EMH-54/3-Q48N-C](#)





Компания «ЭлектроПласт» предлагает заключение долгосрочных отношений при поставках импортных электронных компонентов на взаимовыгодных условиях!

Наши преимущества:

- Оперативные поставки широкого спектра электронных компонентов отечественного и импортного производства напрямую от производителей и с крупнейших мировых складов;
- Поставка более 17-ти миллионов наименований электронных компонентов;
- Поставка сложных, дефицитных, либо снятых с производства позиций;
- Оперативные сроки поставки под заказ (от 5 рабочих дней);
- Экспресс доставка в любую точку России;
- Техническая поддержка проекта, помощь в подборе аналогов, поставка прототипов;
- Система менеджмента качества сертифицирована по Международному стандарту ISO 9001;
- Лицензия ФСБ на осуществление работ с использованием сведений, составляющих государственную тайну;
- Поставка специализированных компонентов (Xilinx, Altera, Analog Devices, Intersil, Interpoint, Microsemi, Aeroflex, Peregrine, Syfer, Eurofarad, Texas Instrument, Miteq, Cobham, E2V, MA-COM, Hittite, Mini-Circuits, General Dynamics и др.);

Помимо этого, одним из направлений компании «ЭлектроПласт» является направление «Источники питания». Мы предлагаем Вам помощь Конструкторского отдела:

- Подбор оптимального решения, техническое обоснование при выборе компонента;
- Подбор аналогов;
- Консультации по применению компонента;
- Поставка образцов и прототипов;
- Техническая поддержка проекта;
- Защита от снятия компонента с производства.



#### Как с нами связаться

**Телефон:** 8 (812) 309 58 32 (многоканальный)

**Факс:** 8 (812) 320-02-42

**Электронная почта:** [org@eplast1.ru](mailto:org@eplast1.ru)

**Адрес:** 198099, г. Санкт-Петербург, ул. Калинина, дом 2, корпус 4, литера А.