

MCR12DSM, MCR12DSN

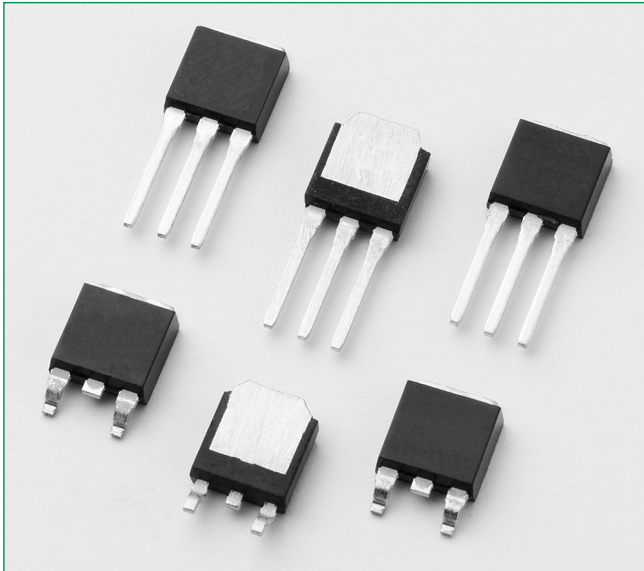

Pin Out

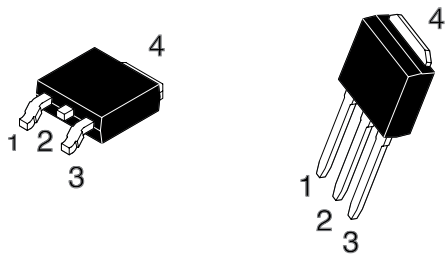

Description

Designed for high volume, low cost, industrial and consumer applications such as motor control; process control; temperature, light and speed control; CDI (Capacitive Discharge Ignition); and small engines.

Features

- Small Size
- Passivated Die Surface for Reliability and Uniformity
- Low Level Triggering and Holding Characteristics
- UL Recognized compound meeting flammability rating V-0
- ESD Ratings: Human Body Model, 3B > 8000 V
Machine Model, C > 400 V

Functional Diagram

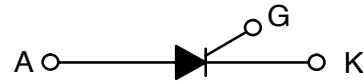

Additional Information



Datasheet



Resources



Samples

Maximum Ratings ($T_J = 25^\circ\text{C}$ unless otherwise noted)

Rating	Symbol	Value	Unit
Peak Repetitive Off-State Voltage (Note 1) ($T_C = -40$ to $+110^\circ\text{C}$, Sine Wave, 50 to 60 Hz, $R_{GK} = 1\text{ k}\Omega$)	MCR12DSM MCR12DSN V_{DRM} V_{RRM}	600 800	V
On-State RMS Current (180° Conduction Angles; $T_C = 75^\circ\text{C}$)	$I_{T(RMS)}$	12	A
Average On-State Current (180° Conduction Angles; $T_C = 75^\circ\text{C}$)	$I_{T(AV)}$	76	A
Non-Repetitive Surge Current (1/2 Cycle, Sine Wave 60 Hz, $T_J = 110^\circ\text{C}$)	I_{TSM}	100	A
Circuit Fusing Consideration ($t = 8.3\text{ ms}$)	I^2t	41	A^2s
Forward Peak Gate Power (Pulse Width $\leq 1.0\text{ }\mu\text{sec}$, $T_C = 75^\circ\text{C}$)	P_{GM}	5.0	W
Forward Average Gate Power ($t = 8.3\text{ ms}$, $T_C = 75^\circ\text{C}$)	$P_{G(AV)}$	0.5	W
Forward Peak Gate Current (Pulse Width $\leq 1.0\text{ }\mu\text{sec}$, $T_C = 75^\circ\text{C}$)	I_{GM}	2.0	A
Operating Junction Temperature Range	T_J	-40 to +110	$^\circ\text{C}$
Storage Temperature Range	T_{stg}	-40 to +150	$^\circ\text{C}$

Stresses exceeding Maximum Ratings may damage the component. Maximum Ratings are stress ratings only. Functional operation above the Recommended Operating Conditions is not implied. Extended exposure to stresses above the Recommended Operating Conditions may affect component reliability.

¹ V_{DRM} and V_{RRM} for all types can be applied on a continuous basis. Ratings apply for zero or negative gate voltage; however, positive gate voltage shall not be applied concurrent with negative potential on the anode. Blocking voltages shall not be tested with a constant current source such that the voltage ratings of the component are exceeded.

Thermal Characteristics

Rating	Symbol	Value	Unit
Thermal Resistance, Junction-to-Case	$R_{\theta JC}$	2.2	$^\circ\text{C/W}$
Thermal Resistance, Junction-to-Ambient	$R_{\theta JA}$	88	
Thermal Resistance, Junction-to-Ambient (Note 2)	$R_{\theta JA}$	80	
Maximum Lead Temperature for Soldering Purposes (Note 3)	T_L	260	$^\circ\text{C}$

Electrical Characteristics - OFF ($T_J = 25^\circ\text{C}$ unless otherwise noted)

Characteristic	Symbol	Min	Typ	Max	Unit	
Peak Repetitive Forward or Reverse Blocking Current ($V_{AK} = \text{Rated } V_{DRM} \text{ or } V_{RRM}$, $R_{GK} = 1.0\text{ k}\Omega$) ⁴	I_{DRM} I_{RRM}	$T_J = 25^\circ\text{C}$	-	-	10	μA
		$T_J = 110^\circ\text{C}$	-	-	500	

Electrical Characteristics - ON ($T_J = 25^\circ\text{C}$ unless otherwise noted)

Characteristic	Symbol	Min	Typ	Max	Unit	
Peak Reverse Gate Blocking Voltage, ($I_{GR} = 10\text{ }\mu\text{A}$)	V_{GRM}	10	12.5	18	V	
Peak Reverse Gate Blocking Current, ($V_{GR} = 10\text{ V}$)	I_{GRM}	-	-	1.2	μA	
Peak Forward On-State Voltage (Note 5), ($I_{TM} = 20\text{ A}$)	V_{TM}	-	1.3	1.9	V	
Gate Trigger Voltage (Note 6) ($V_{AK} = 12\text{ Vdc}$; $R_L = 100\text{ }\Omega$, $T_C = 110^\circ$)	I_{GT}	$T_J = 25^\circ\text{C}$	5.0	12	200	μA
		$T_J = -40^\circ\text{C}$	-	-	300	
Gate Trigger Voltage (Continuous dc) (Note 6) ($V_{AK} = 12\text{ V}$; $R_L = 100\text{ }\Omega$)	V_{GT}	$T_J = 25^\circ\text{C}$	0.45	0.65	1.0	V
		$T_J = -40^\circ\text{C}$	-	-	1.5	
		$T_J = 110^\circ\text{C}$	0.2	-	-	
Holding Current ($V_D = 12\text{ V}$, Initiating Current = 200 mA, $R_{GK} = 1\text{ k}\Omega$)	I_H	$T_J = 25^\circ\text{C}$	0.5	1.0	6.0	mA
		$T_J = -40^\circ\text{C}$	-	-	10	
Latching Current ($V_D = 12\text{ V}$, $I_G = 2.0\text{ mA}$, $R_{GK} = 1\text{ k}\Omega$)	I_L	$T_J = 25^\circ\text{C}$	0.5	1.0	6.0	mA
		$T_J = -40^\circ\text{C}$	-	-	10	
Peak Reverse Gate Blocking Current ($V_{GR} = 10\text{ V}$)	I_{RGM}	-	-	1.2	μA	
Turn-On Time (Source Voltage = 12 V, $R_S = 6.0\text{ k}\Omega$, $I_T = 16\text{ A(pk)}$, $R_{GK} = 1.0\text{ k}\Omega$) ($V_D = \text{Rated } V_{DRM}$, Rise Time = 20 ns, Pulse Width = 10 μs)	t_{gt}	-	2.0	5.0	μs	

Dynamic Characteristics

Characteristic	Symbol	Min	Typ	Max	Unit
Critical Rate of Rise of Off-State Voltage (VD = 0.67 x Rated VDRM, Exponential Waveform, RGK = 1.0 K, TJ = 110°C)	dv/dt	2.0	10	-	V/μs
Critical Rate of Rise of On-State Current (IPK = 50 A, PW = 40 sec, diG/dt = 1 A/sec, IGT = 10 mA)	di/dt	-	50	100	A/μs

2. These ratings are applicable when surface mounted on the minimum pad sizes recommended.
3. 1/8" from case for 10 seconds.
4. Ratings apply for negative gate voltage or $R_{GK} = 1.0\text{ k}\Omega$. Devices shall not have a positive gate voltage concurrently with a negative voltage on the anode. Component should not be tested with a constant current source for forward and reverse blocking capability such that the voltage applied exceeds the rated blocking voltage.
5. Pulse Test: Pulse Width $\leq 2.0\text{ msec}$, Duty Cycle $\leq 2\%$.
6. R_{GK} current not included in measurement.

Voltage Current Characteristic of SCR

Symbol	Parameter
V_{DRM}	Peak Repetitive Forward Off State Voltage
I_{DRM}	Peak Forward Blocking Current
V_{RRM}	Peak Repetitive Reverse Off State Voltage
I_{RRM}	Peak Reverse Blocking Current
V_{TM}	Maximum On State Voltage
I_H	Holding Current

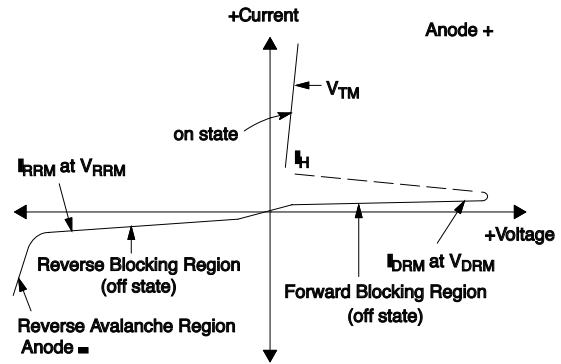

Figure 1. Average Current Derating

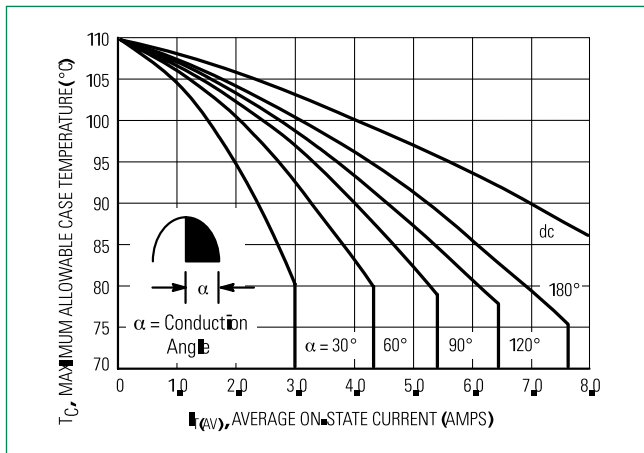

Figure 2. On-State Power Dissipation

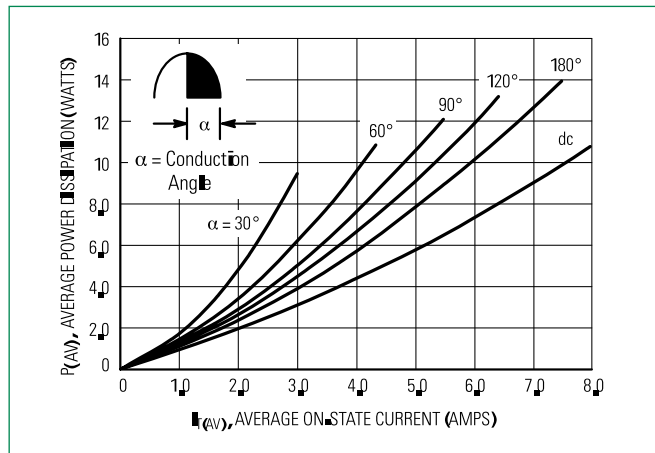

Figure 3. On-State Characteristics

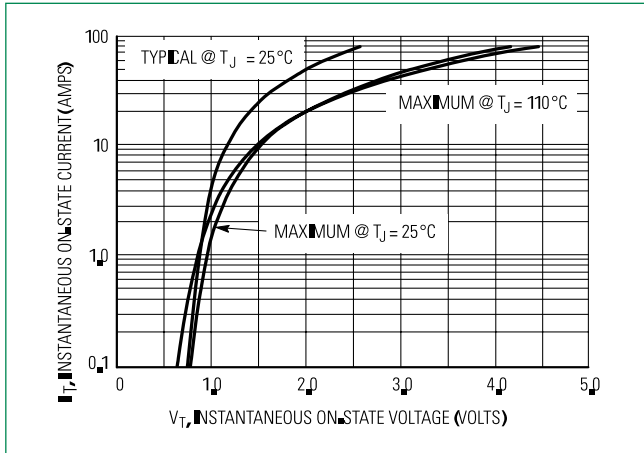

Figure 4. Transient Thermal Response

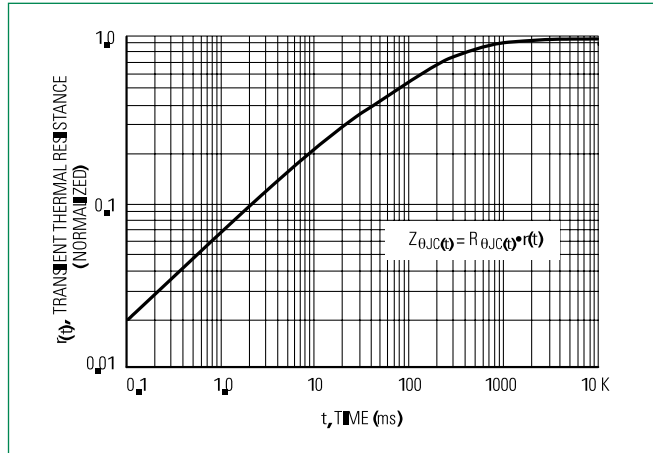

Figure 5. Typical Gate Trigger Current vs. Junction Temperature

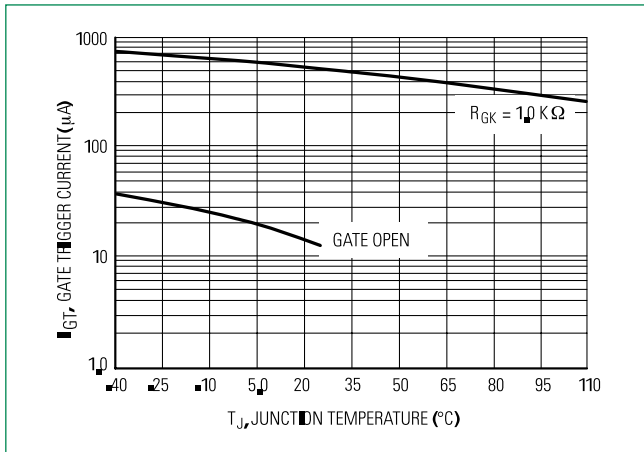

Figure 6. Typical Gate Trigger Voltage vs. Junction Temperature

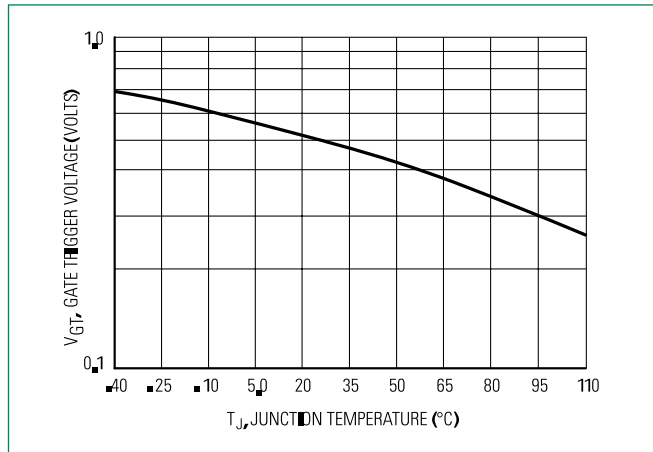

Figure 7. Typical Holding Current vs. Junction Temperature

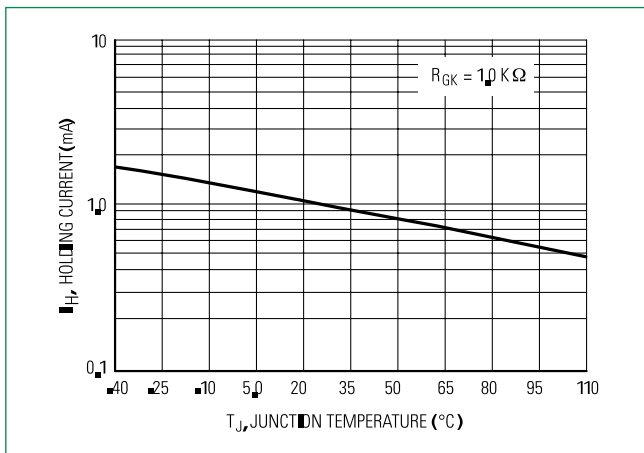

Figure 8. Typical Latching Current vs. Junction Temperature

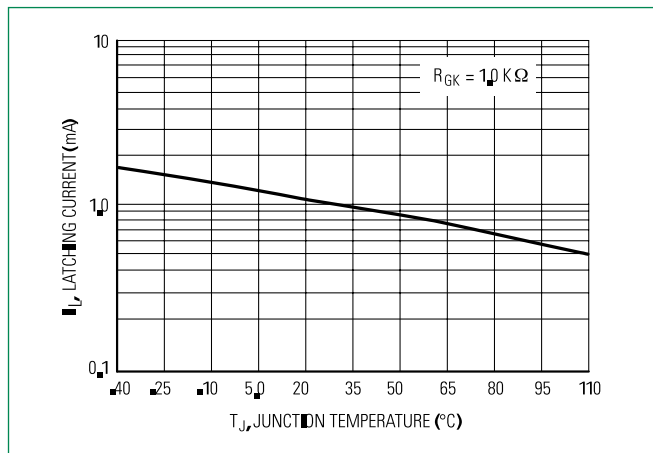

Figure 9. Holding Current vs Gate-Cathode Resistance

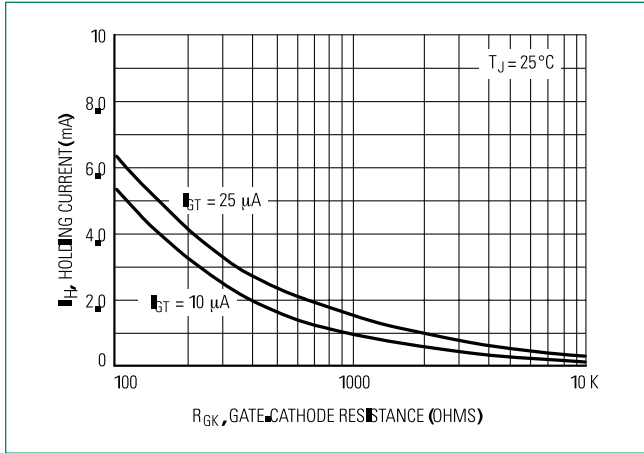

Fig. 10 Exponential Static dv/dt vs Gate-Cathode Resistance & Junction Temp

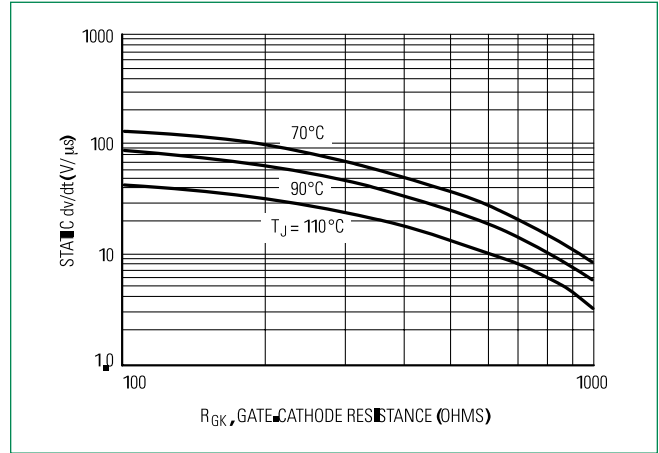

Figure 11. Typical Gate Trigger Current vs Junction Temperature

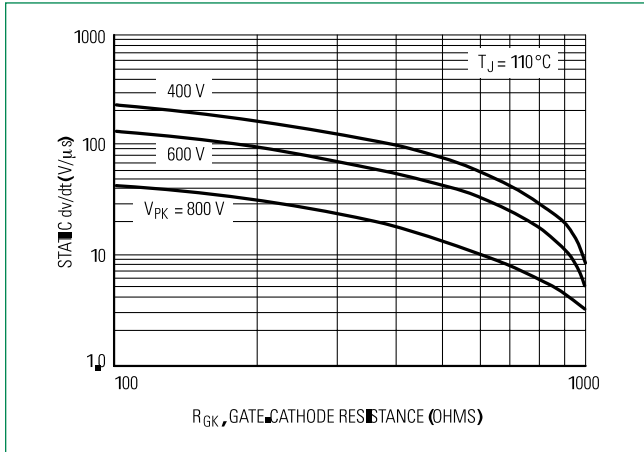
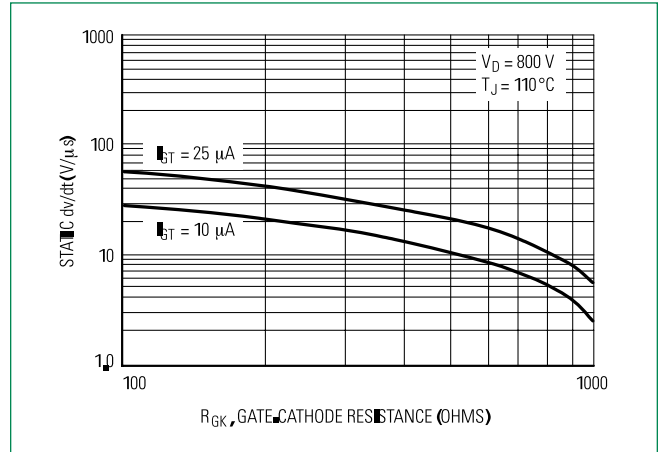
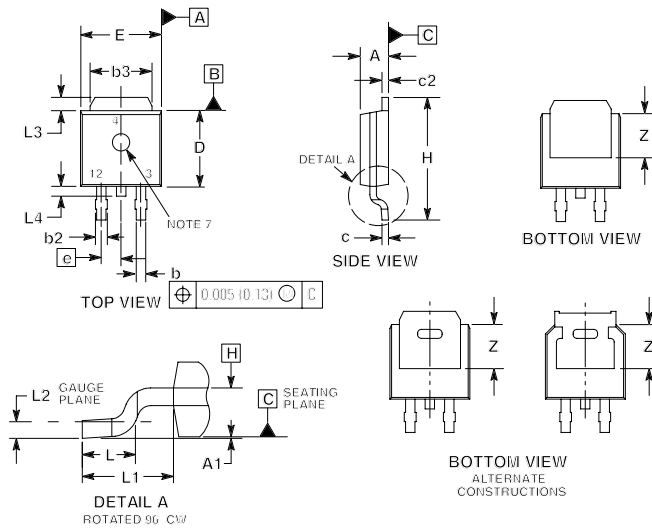

Figure 12. Typical Gate Trigger Voltage vs Junction Temperature



Dimensions



Soldering Footprint

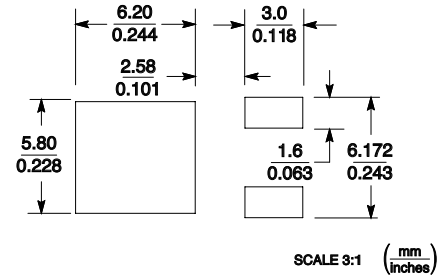

Dim	Inches		Millimeters	
	Min	Max	Min	Max
A	0.087	0.094	2.20	2.40
A1	0.000	0.005	0.00	0.12
b	0.022	0.030	0.55	0.75
b2	0.026	0.033	0.65	0.85
b3	0.209	0.217	5.30	5.50
c	0.019	0.023	0.49	0.59
c2	0.019	0.023	0.49	0.59
D	0.213	0.224	5.40	5.70
E	0.252	0.260	6.40	6.60
e	0.091		2.30	
H	0.374	0.406	9.50	10.30
L	0.058	0.070	1.47	1.78
L1	0.114		2.90	
L2	0.019	0.023	0.49	0.59
L3	0.053	0.065	1.35	1.65
L4	0.028	0.039	0.70	1.00
Z	0.154	-	3.90	-

- DIMENSIONING AND TOLERANCING PER ASME Y14.5M, 1994.
- CONTROLLING DIMENSION: INCH.
- THERMAL PAD CONTOUR OPTIONAL WITHIN DIMENSIONS b3, L3 and Z.
- DIMENSIONS D AND E DO NOT INCLUDE MOLD FLASH, PROTRUSIONS, OR BURRS. MOLD FLASH, PROTRUSIONS, OR GATE BURRS SHALL L3 Z NOT EXCEED 0.006 INCHES PER SIDE.
- DIMENSIONS D AND E ARE DETERMINED AT THE OUTERMOST EXTREMES OF THE PLASTIC BODY.
- DATUMS A AND B ARE DETERMINED AT DATUM PLANE H.

Dimensions

DPAK CASE 369D ISSUE C

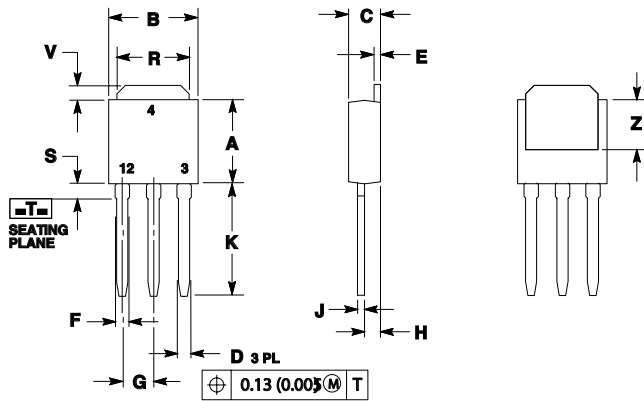

Dim	Inches		Millimeters	
	Min	Max	Min	Max
A	0.213	0.224	5.40	5.70
B	0.252	0.260	6.40	6.60
C	0.087	0.094	2.20	2.40
D	0.024	0.030	0.60	0.75
E	0.022	0.026	0.55	0.65
F	0.031	0.039	0.78	0.98
G	0.091		2.30	
H	0.046	0.050	1.18	1.28
J	0.019	0.023	0.49	0.59
K	0.291	0.315	7.40	8.00
R	0.209	0.217	5.30	5.50
S	0.063		1.60	
V	0.053	0.065	1.35	1.65
Z	0.150		3.80	

1. DIMENSIONING AND TOLERANCING PER ANSI Y14.5M, 1982.
2. CONTROLLING DIMENSION: INCH.

Part Marking System

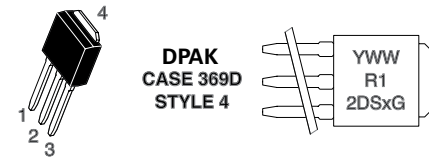

Y= Year
 WW = Work Week
 R12DSx = Device Code
 x= M or N
 G= Pb-Free Package

Pin Assignment

Pin	Assignment
1	Cathode
2	Anode
3	Gate
4	Anode

Ordering Information

Device	Package Type	Package	Shipping
MCR12DSMT4G	DPAK	369C	2500 Tape & Reel
MCR12DSN-1G	IPAK	369D	4000 Units/Box
MCR12DSNT4G	DPAK	369C	2500 Tape & Reel

Disclaimer Notice - Information furnished is believed to be accurate and reliable. However, users should independently evaluate the suitability of and test each product selected for their own applications. Littelfuse products are not designed for, and may not be used in, all applications. Read complete Disclaimer Notice at: www.littelfuse.com/disclaimer-electronics



Компания «ЭлектроПласт» предлагает заключение долгосрочных отношений при поставках импортных электронных компонентов на взаимовыгодных условиях!

Наши преимущества:

- Оперативные поставки широкого спектра электронных компонентов отечественного и импортного производства напрямую от производителей и с крупнейших мировых складов;
- Поставка более 17-ти миллионов наименований электронных компонентов;
- Поставка сложных, дефицитных, либо снятых с производства позиций;
- Оперативные сроки поставки под заказ (от 5 рабочих дней);
- Экспресс доставка в любую точку России;
- Техническая поддержка проекта, помощь в подборе аналогов, поставка прототипов;
- Система менеджмента качества сертифицирована по Международному стандарту ISO 9001;
- Лицензия ФСБ на осуществление работ с использованием сведений, составляющих государственную тайну;
- Поставка специализированных компонентов (Xilinx, Altera, Analog Devices, Intersil, Interpoint, Microsemi, Aeroflex, Peregrine, Syfer, Eurofarad, Texas Instrument, Miteq, Cobham, E2V, MA-COM, Hittite, Mini-Circuits, General Dynamics и др.);

Помимо этого, одним из направлений компании «ЭлектроПласт» является направление «Источники питания». Мы предлагаем Вам помощь Конструкторского отдела:

- Подбор оптимального решения, техническое обоснование при выборе компонента;
- Подбор аналогов;
- Консультации по применению компонента;
- Поставка образцов и прототипов;
- Техническая поддержка проекта;
- Защита от снятия компонента с производства.



Как с нами связаться

Телефон: 8 (812) 309 58 32 (многоканальный)

Факс: 8 (812) 320-02-42

Электронная почта: org@eplast1.ru

Адрес: 198099, г. Санкт-Петербург, ул. Калинина, дом 2, корпус 4, литера А.