

NJG1709KC1

■ABSOLUTE MAXIMUM RATINGS

($T_a=+25^{\circ}\text{C}$, $Z_s=Z_l=50\Omega$)

PARAMETER	SYMBOL	CONDITIONS	RATINGS	UNITS
LNA Voltage	V_{LNA}		5.0	V
Mixer Voltage	V_{MIX}		5.0	V
Local Amplifier Voltage	V_{LO}		5.0	V
Input Power 1	P_{LNAIN}	$V_{LNA}=V_{MIX}=V_{LO}=2.7V$	+15	dBm
Input Power 2	P_{LOIN}	$V_{LNA}=V_{MIX}=V_{LO}=2.7V$	+10	dBm
Power Dissipation	P_D		550	mW
Operating Temperature	T_{opr}		-40~+85	$^{\circ}\text{C}$
Storage Temperature	T_{stg}		-55~+125	$^{\circ}\text{C}$

■ELECTRICAL CHARACTERISTICS 1 (LNA)

GENERAL CONDITIONS: $T_a=+25^{\circ}\text{C}$, $V_{LNA}=2.7V$, $V_{MIX}=V_{LO}=0V$, $f_{RF}=1489\text{MHz}$, $P_{RF}=-36\text{dBm}$, $Z_s=Z_l=50\Omega$, with test circuit 1

PARAMETER	SYMBOL	CONDITIONS	MIN	TYP	MAX	UNITS
Operating Frequency	freq		1470	1489	1510	MHz
LNA Voltage	V_{LNA}		2.5	2.7	4.5	V
LNA Operating Current	I_{LNA}	P_{RF} , $P_{LO}=\text{OFF}$	-	3.2	4.1	mA
Small Signal Gain	Gain		16.0	18.0	20.0	dB
Gain Flatness	G_{flat}	$f_{RF}=1470\sim 1520\text{MHz}$	-	0.5	1.0	dB
Noise Figure	NF		-	1.2	1.5	dB
Pout at 1dB Gain Compression point	P_{-1dB}		-3.0	-1.0	-	dBm
Output 3rd order Intercept point	OIP3	$f_{RF}=1489.0+1489.1\text{MHz}$	+8.0	+13.0	-	dBm
RF IN VSWR	$VSWR_i$		-	1.5	-	
RF OUT VSWR	$VSWR_o$		-	1.5	-	

■ELECTRICAL CHARACTERISTICS 2 (Mixer)

GENERAL CONDITIONS: $T_a=+25^{\circ}\text{C}$, $V_{LNA}=0V$, $V_{MIX}=V_{LO}=2.7V$, $f_{RF}=1489\text{MHz}$, $f_{LO}=1619\text{MHz}$, $P_{RF}=-30\text{dBm}$, $P_{LO}=-15\text{dBm}$, $Z_s=Z_l=50\Omega$, with test circuit 1

PARAMETER	SYMBOL	CONDITIONS	MIN	TYP	MAX	UNITS
Operating Frequency	freq		1470	1489	1510	MHz
Mixer Voltage	V_{MIX}		2.5	2.7	4.5	V
Local Amplifier Voltage	V_{LO}		2.5	2.7	4.5	V
Mixer Operating Current	I_{MIX}	P_{RF} , $P_{LO}=\text{OFF}$	-	4.3	5.7	mA
Local Amplifier Operating Current	I_{LO}	P_{RF} , $P_{LO}=\text{OFF}$	-	0.8	1.3	mA
Conversion Gain	G_c		11.0	12.5	-	dB
Noise Figure	NF		-	6.0	9.0	dB
Output 3rd Order Intercept Point	OIP3	$f_{RF}=1489.0+1489.1\text{MHz}$	+7.0	+10.0	-	dBm
MIXER IN VSWR	$VSWR_M$		-	1.5	-	
LOCAL IN VSWR	$VSWR_l$		-	1.5	-	
IF OUT VSWR	$VSWR_i$		-	1.5	-	

■ ELECTRICAL CHARACTERISTICS 3 (LNA)

GENERAL CONDITIONS: $T_a=+25^{\circ}\text{C}$, $V_{\text{LNA}}=2.7\text{V}$, $V_{\text{MIX}}=V_{\text{LO}}=0\text{V}$, $f_{\text{RF}}=1900\text{MHz}$, $P_{\text{RF}}=-36\text{dBm}$,
 $Z_s=Z_i=50\Omega$, with test circuit 2

PARAMETER	SYMBOL	CONDITIONS	MIN	TYP	MAX	UNITS
Operating Frequency	freq		1890	1900	1920	MHz
LNA Voltage	V_{LNA}		2.5	2.7	4.5	V
LNA Operating Current	I_{LNA}	$P_{\text{RF}}, P_{\text{LO}}=\text{OFF}$	-	3.2	4.1	mA
Small Signal Gain	Gain		14.0	16.0	18.0	dB
Gain Flatness	G_{flat}	$f_{\text{RF}}=1890\sim 1920\text{MHz}$	-	0.5	1.0	dB
Noise Figure	NF		-	1.3	1.5	dB
Pout at 1dB Gain Compression point	$P_{-1\text{dB}}$		-2.0	0	-	dBm
Output 3rd Order Intercept point	OIP3	$f_{\text{RF}}=1900.0+1900.1\text{MHz}$	+9.0	+13.0	-	dBm
RF IN VSWR	VSWR_i		-	2.0	-	
RF OUT VSWR	VSWR_o		-	2.0	-	

■ ELECTRICAL CHARACTERISTICS 4 (Mixer)

GENERAL CONDITIONS: $T_a=+25^{\circ}\text{C}$, $V_{\text{LNA}}=0\text{V}$, $V_{\text{MIX}}=V_{\text{LO}}=2.7\text{V}$, $f_{\text{RF}}=1900\text{MHz}$, $f_{\text{LO}}=1660\text{MHz}$
 $P_{\text{RF}}=-30\text{dBm}$, $P_{\text{LO}}=-15\text{dBm}$, $Z_s=Z_i=50\Omega$, with test circuit 2

PARAMETER	SYMBOL	CONDITIONS	MIN	TYP	MAX	UNITS
Operating Frequency	freq		1890	1900	1920	MHz
Mixer Voltage	V_{MIX}		2.5	2.7	4.5	V
Local Amplifier Voltage	V_{LO}		2.5	2.7	4.5	V
Mixer Operating Current	I_{MIX}	$P_{\text{RF}}, P_{\text{LO}}=\text{OFF}$	-	4.3	5.7	mA
Local Amplifier Operating Current	I_{LO}	$P_{\text{RF}}, P_{\text{LO}}=\text{OFF}$	-	0.8	1.3	mA
Conversion Gain	G_c		7.0	9.0	-	dB
Noise Figure	NF		-	6.5	9.0	dB
Output 3rd Order Intercept point	OIP3	$f_{\text{RF}}=1900.0+1900.1\text{MHz}$	+7.0	+11.0	-	dBm
MIXER IN VSWR	VSWR_M		-	1.5	-	
LOCAL IN VSWR	VSWR_L		-	1.5	-	
IF OUT VSWR	VSWR_I		-	1.5	-	

NJG1709KC1

■TERMINAL INFORMATION

No.	SYMBOL	FUNCTION
1	LNAIN	RF input terminal of LNA. An external matching circuit is required.
2	LNACAP	Terminal for the bypass capacitor of LNA. The bypass capacitor C1 shown in test circuits should be connected to this terminal as close as possible.
3	GND	Ground terminal (0V)
4	IFOUT	IF signal output terminal. The IF signal is output through external matching circuit connected to this terminal. Please connect inductances L7, L8 and power supply as shown in test circuits, since this terminal is also the terminal of mixer power supply.
5	VLO	Power supply terminal for local amplifier. Please place R1, R2 and L11 shown in test circuits at very close to this terminal.
6	LOIN	Local signal input terminal to local amplifier. An external matching circuit is required.
7	BPC	Terminal for the bypass capacitor of mixer. The bypass capacitor C4 shown in test circuits should be connected to this terminal as close as possible.
8	MIXIN	RF signal input terminal to mixer. An external matching circuit is required.
9	GND	Ground terminal (0V)
10	LNAOUT	Signal output terminal of LNA. The RF signal from LNA goes out through external matching circuit connected to this terminal. Please connect inductances L3, L4 and power supply as shown in test circuits, since this terminal is also the terminal of LNA power supply.

CAUTION

- 1) Ground terminal (No.3, 9) should be connected to the ground plane as close as possible.

■ TYPICAL CHARACTERISTICS 1 (LNA, $f=1.5\text{GHz}$, $f_{LO}=1619\text{MHz}$, with test circuit 1)

Gain, NF vs. Frequency

($V_{LNA}=2.7\text{V}$)

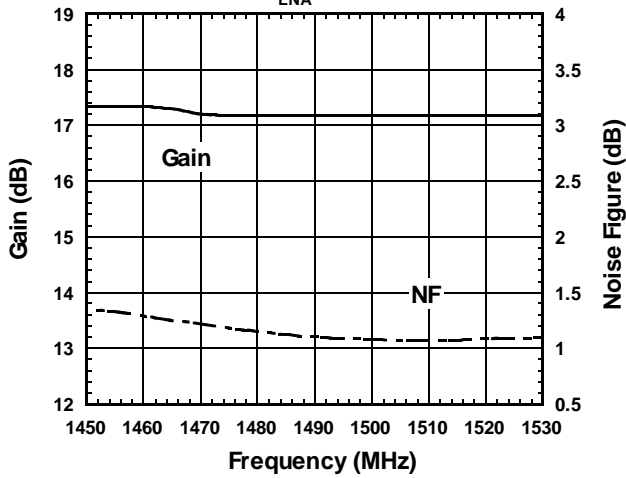

Pout vs. Pin

($V_{LNA}=2.7\text{V}$, $f=1489\text{MHz}$)

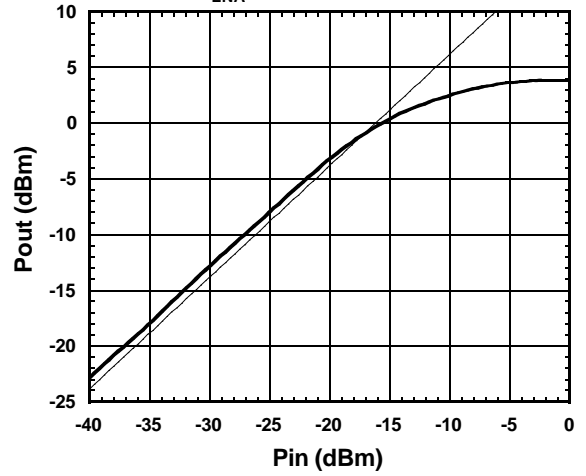

Pout, IM3 vs. Pin

($V_{LNA}=2.7\text{V}$, $f=1489+1489.1\text{MHz}$)

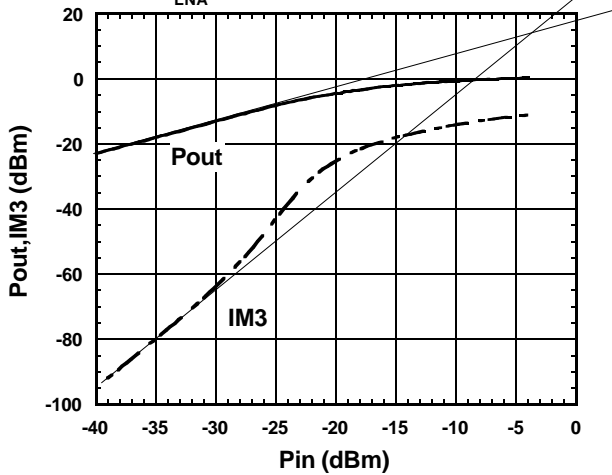

Gain, NF vs. V_{LNA}
($f=1489\text{MHz}$)

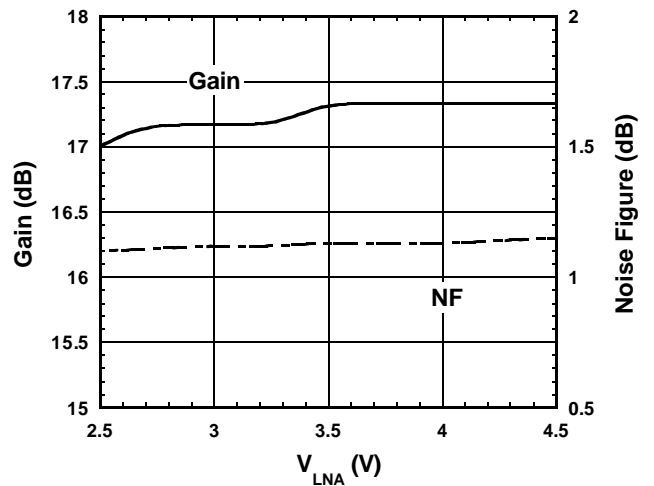

I_{LNA} vs. V_{LNA}

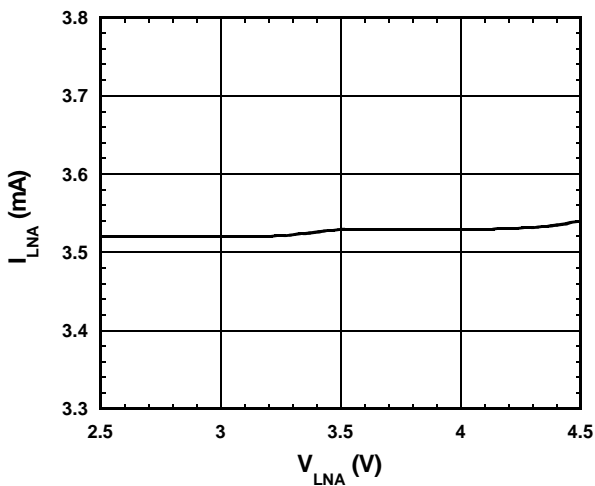

P-1dB vs. V_{LNA}
($f=1489\text{MHz}$)

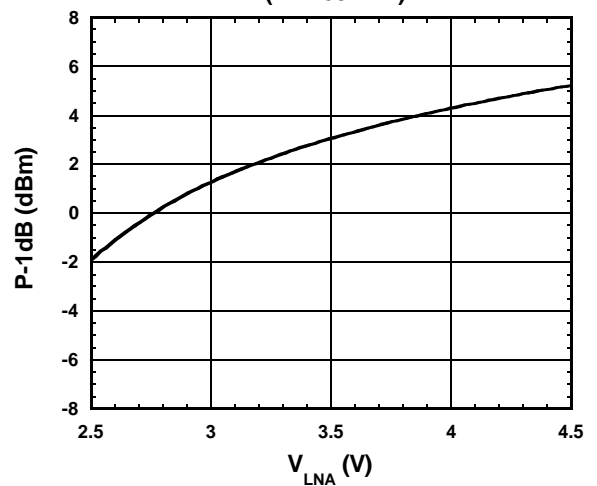

NJG1709KC1

■ TYPICAL CHARACTERISTICS 1 (LNA, f=1.5GHz, f_{LO}=1619MHz, with test circuit 1)

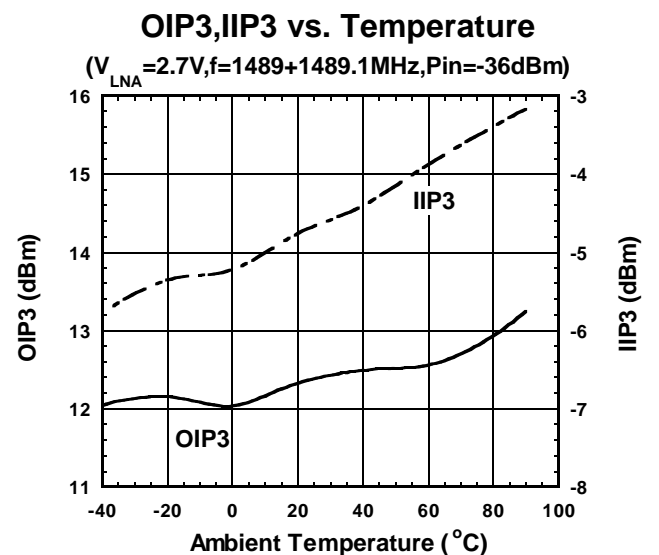
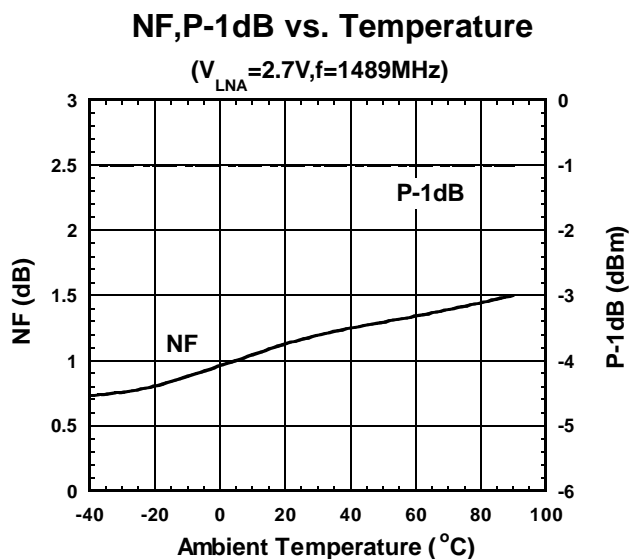
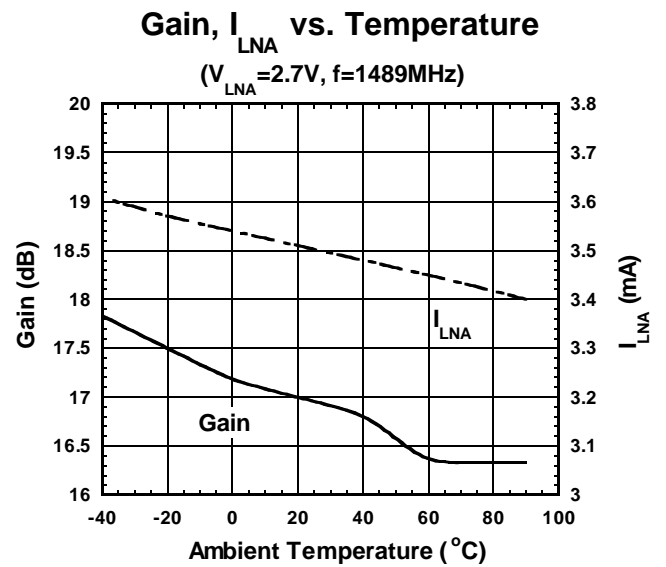
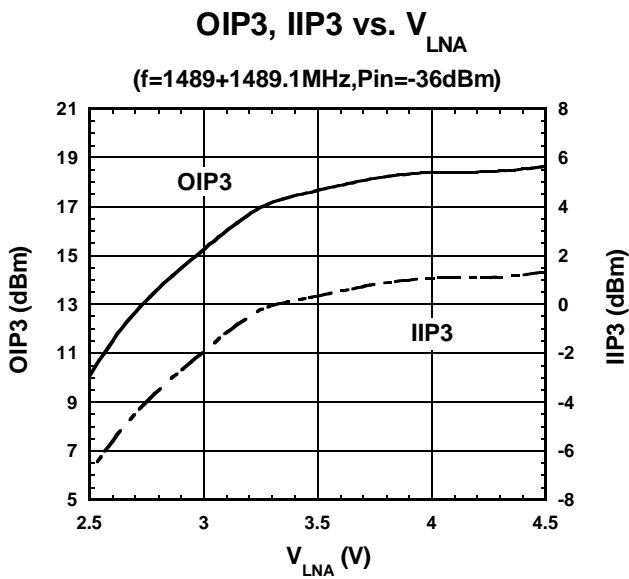

The value of OIP3 and IIP3 shown in typical characteristics are calculated

$$OIP3 = \frac{3 \times P_{out} - IM3}{2}$$

$$IIP3 = OIP3 - Gain \quad @ Pin = -36dBm$$

■ TYPICAL CHARACTERISTICS 1 (LNA, $f=1.5\text{GHz}$, $f_{LO}=1619\text{MHz}$, with test circuit 1)

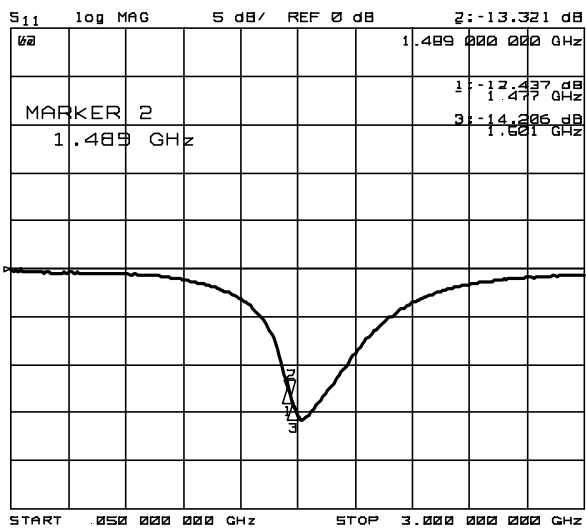

S11

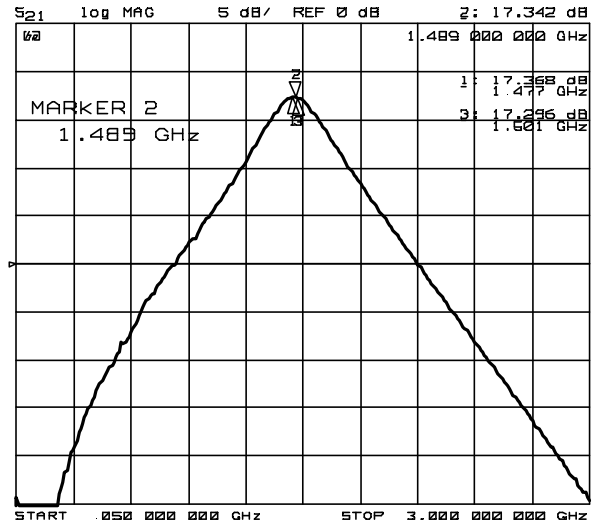

S21

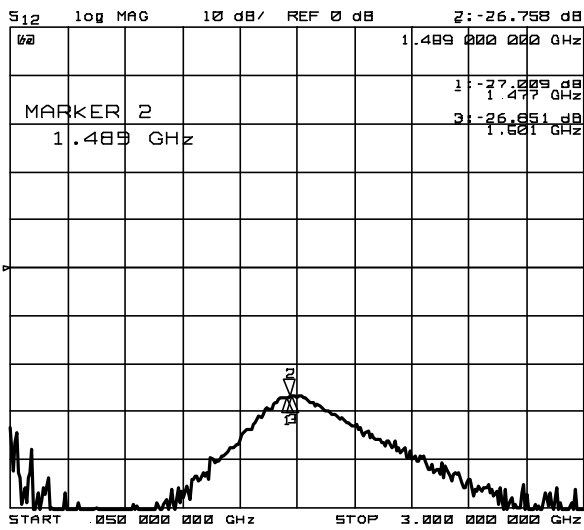

S12

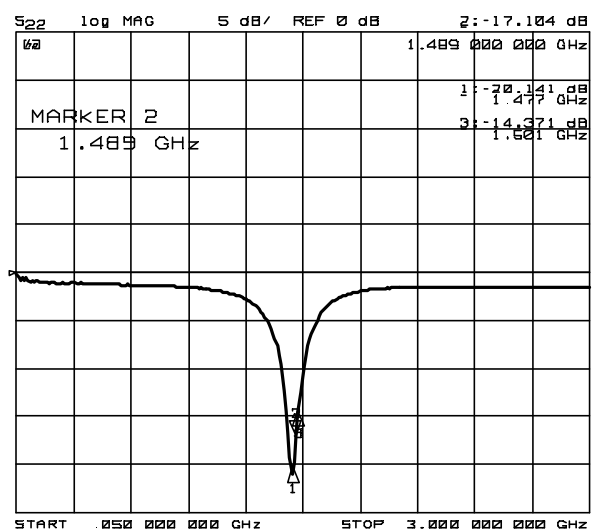

S22

Condition

$$V_{LNA}=2.7V$$

$$V_{MIX}=V_{LO}=0V$$

NJG1709KC1

■ TYPICAL CHARACTERISTICS 1 (MIXER, $f=1.5\text{GHz}$, $f_{LO}=1619\text{MHz}$, with test circuit 1)

Conversion Gain, Noise Figure vs. RF Frequency

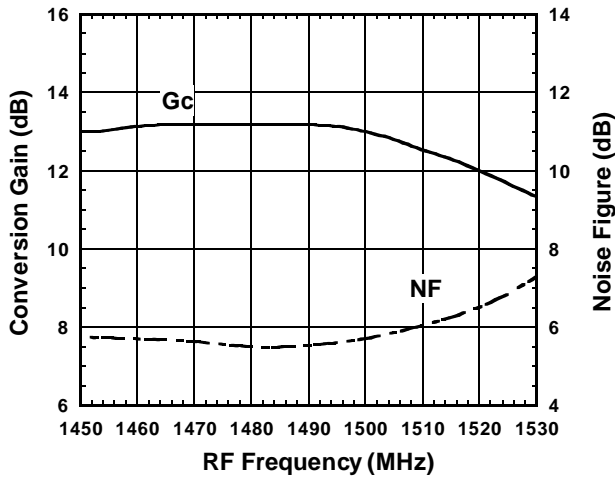

Condition
 $f_{IF}=130\text{MHz}$
 $P_{RF}=-30\text{dBm}$
 $P_{LO}=-15\text{dBm}$
 $V_{MIX}=V_{LO}=2.7\text{V}$
 Upper LOCAL

Conversion Gain, Noise Figure vs. LO Power

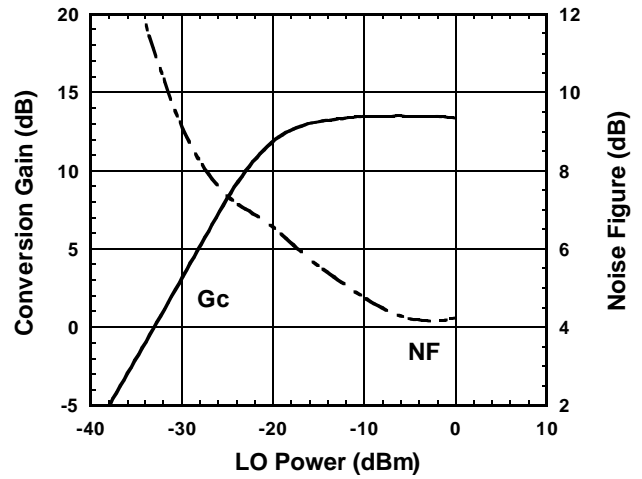

Condition
 $f_{IF}=130\text{MHz}$
 $f_{RF}=1489\text{MHz}$, $P_{RF}=-30\text{dBm}$
 $f_{LO}=1619\text{MHz}$
 $V_{MIX}=V_{LO}=2.7\text{V}$

OIP3, IIP3 vs. LO Power

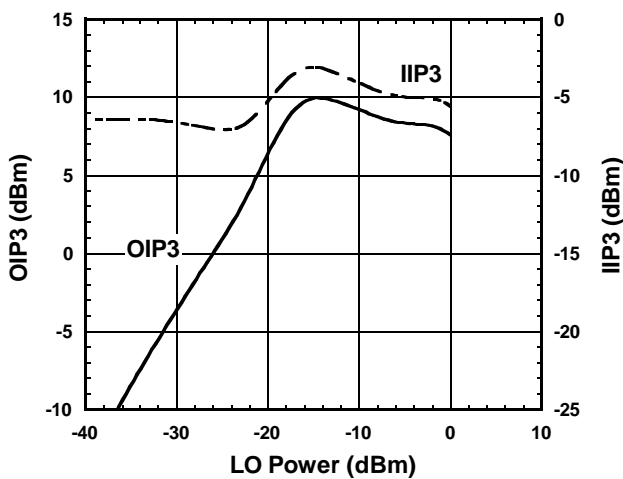

Condition
 $f_{IF}=130\text{MHz}$
 $f_{RF1}=1489.0\text{MHz}$, $P_{RF}=-30\text{dBm}$
 $f_{RF2}=1489.1\text{MHz}$
 $f_{LO}=1619\text{MHz}$
 $V_{MIX}=V_{LO}=2.7\text{V}$

$$OIP3 = \frac{3 \times IF - IM3}{2}$$

$$IIP3 = OIP3 - Gc$$
 @ $P_{RF} = -30\text{dBm}$

■ TYPICAL CHARACTERISTICS 1 (MIXER, $f=1.5\text{GHz}$, $f_{LO}=1619\text{MHz}$, with test circuit 1)

Conversion Gain, Noise Figure

vs. V_{MIX} , V_{LO}

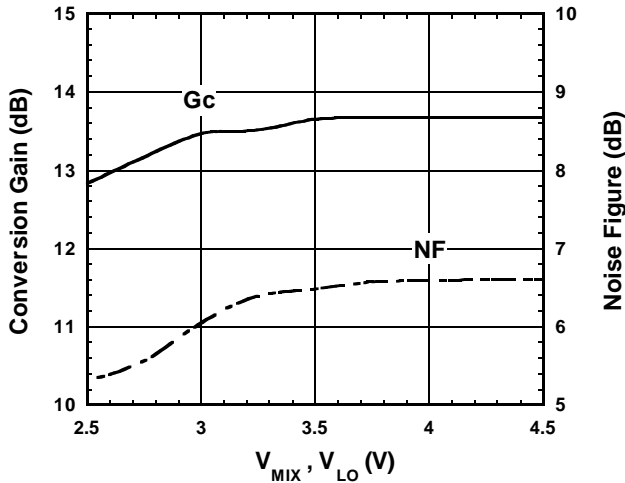

Condition

$f_{IF}=130\text{MHz}$
 $f_{RF}=1489\text{MHz}$, $P_{RF}=-30\text{dBm}$
 $f_{LO}=1619\text{MHz}$, $P_{LO}=-15\text{dBm}$

OIP3, IIP3 vs. V_{MIX} , V_{LO}

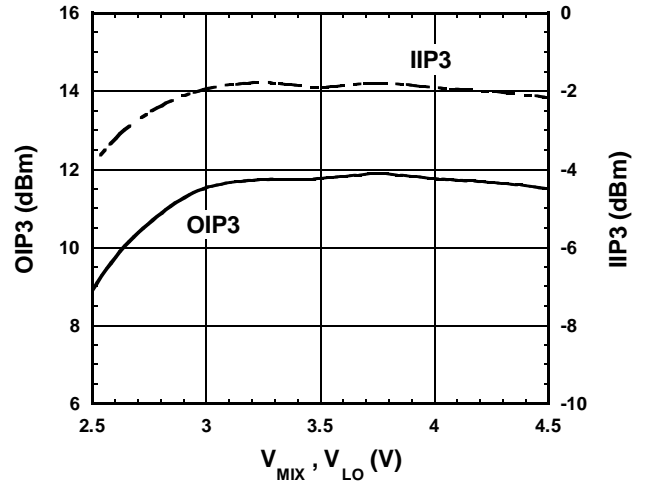

Condition

$f_{IF}=130\text{MHz}$
 $f_{RF1}=1489.0\text{MHz}$, $P_{RF}=-30\text{dBm}$
 $f_{RF2}=1489.1\text{MHz}$
 $f_{LO}=1619\text{MHz}$, $P_{LO}=-15\text{dBm}$

$$OIP3 = \frac{3 \times IF - IM3}{2}$$

$$IIP3 = OIP3 - Gc$$
 @ $P_{RF} = -30\text{dBm}$

IF, IM3 vs. RF Power

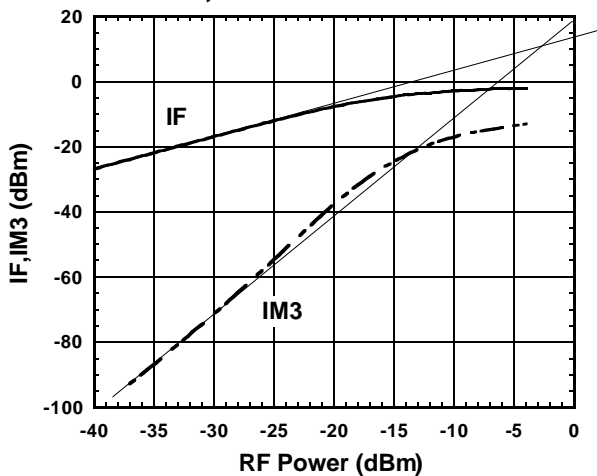

Condition

$f_{IF}=130\text{MHz}$
 $f_{RF1}=1489.0\text{MHz}$
 $f_{RF2}=1489.1\text{MHz}$
 $f_{LO}=1619\text{MHz}$, $P_{LO}=-15\text{dBm}$
 $V_{MIX}=V_{LO}=2.7\text{V}$

IF Output Power vs. RF Power

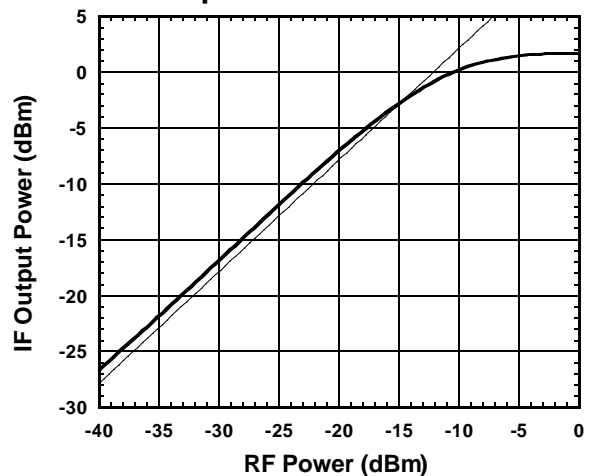

Condition

$f_{IF}=130\text{MHz}$
 $f_{RF}=1489\text{MHz}$
 $f_{LO}=1619\text{MHz}$, $P_{LO}=-15\text{dBm}$
 $V_{MIX}=V_{LO}=2.7\text{V}$

NJG1709KC1

■ TYPICAL CHARACTERISTICS 1 (MIXER, $f=1.5\text{GHz}$, $f_{LO}=1619\text{MHz}$, with test circuit 1)

**Conversion Gain vs. LO Power
Temperature Response**

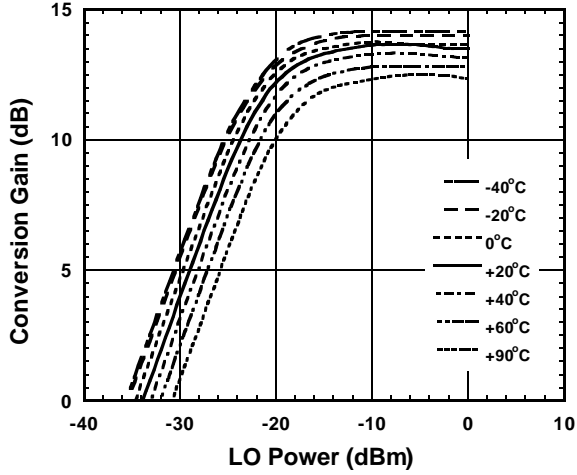

Condition

$f_{IF}=130\text{MHz}$
 $f_{RF}=1489\text{MHz}$, $P_{RF}=-30\text{dBm}$
 $f_{LO}=1619\text{MHz}$
 $V_{MIX}=V_{LO}=2.7\text{V}$

**Noise Figure vs. LO Power
Temperature Response**

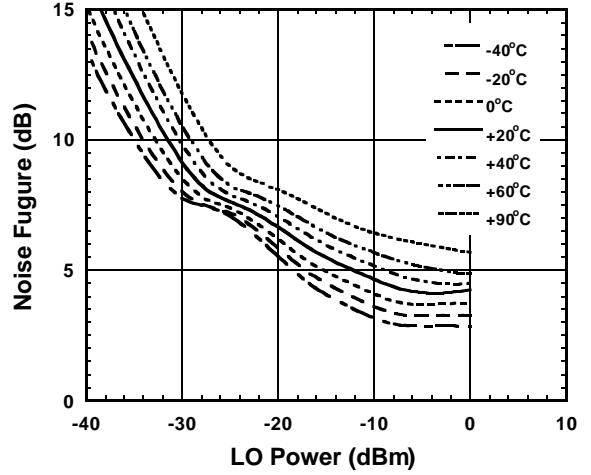

Condition

$f_{IF}=130\text{MHz}$
 $f_{RF}=1489\text{MHz}$
 $f_{LO}=1619\text{MHz}$
 $V_{MIX}=V_{LO}=2.7\text{V}$

**IIP3 vs. LO Power
Temperature Response**

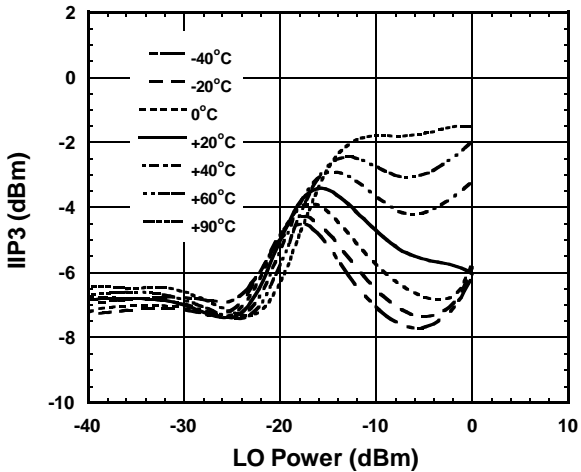

Condition

$f_{IF}=130\text{MHz}$
 $f_{RF1}=1489.0\text{MHz}$, $P_{RF}=-30\text{dBm}$
 $f_{RF2}=1489.1\text{MHz}$
 $f_{LO}=1619\text{MHz}$
 $V_{MIX}=V_{LO}=2.7\text{V}$

$$IIP3 = \frac{3 \times IF - IM3}{2} - Gc$$

@ $P_{RF} = -30\text{dBm}$

■ TYPICAL CHARACTERISTICS 1 (MIXER, $f=1.5\text{GHz}$, $f_{LO}=1619\text{MHz}$, with test circuit 1)

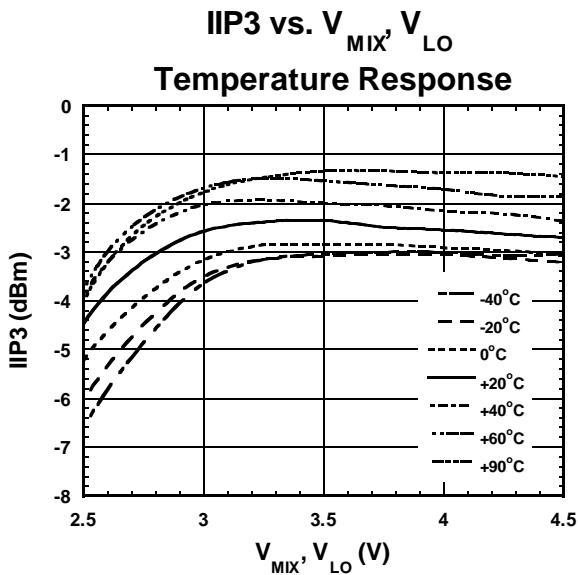
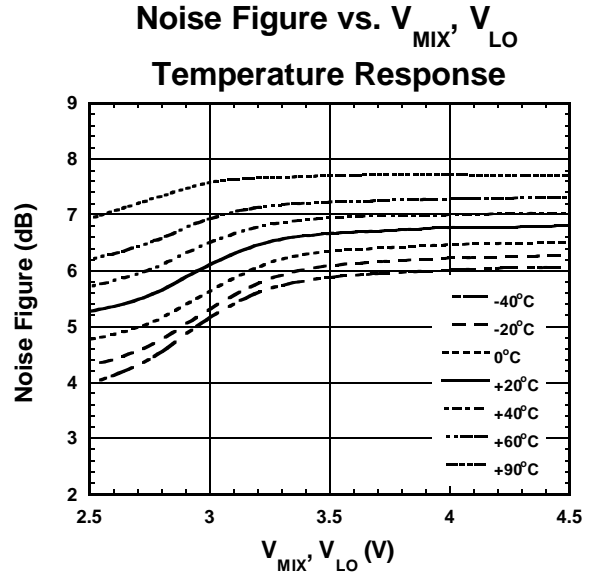
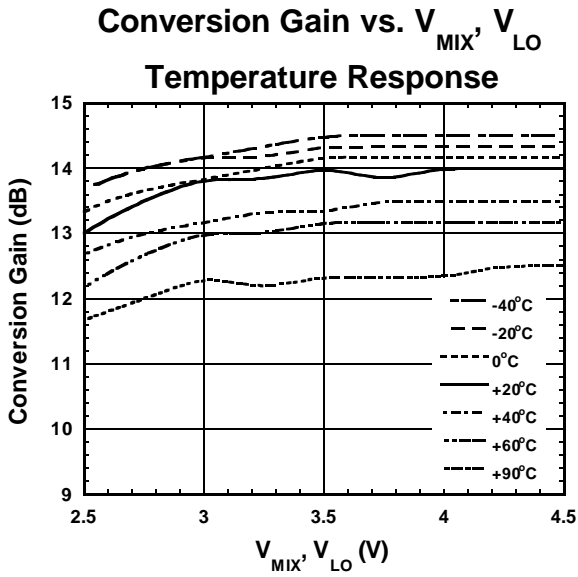

NJG1709KC1

■ TYPICAL CHARACTERISTICS 1 (MIXER, $f=1.5\text{GHz}$, $f_{LO}=1619\text{MHz}$, with test circuit 1)

MIXER IN PORT IMPEDANCE ($P_{LO}=-15\text{dBm}$)

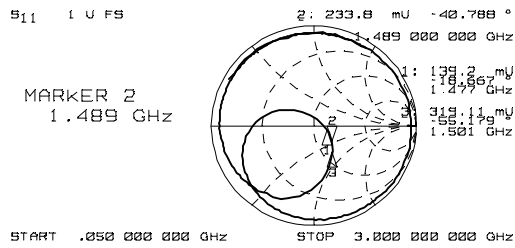
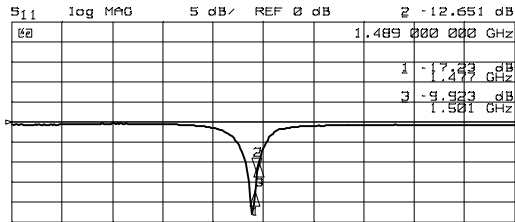

Condition
 $V_{LNA}=0V$
 $V_{MIX}=V_{LO}=2.7V$

LOCAL IN PORT IMPEDANCE

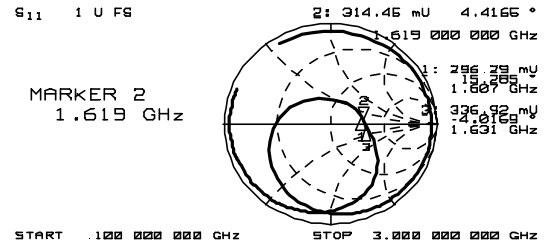
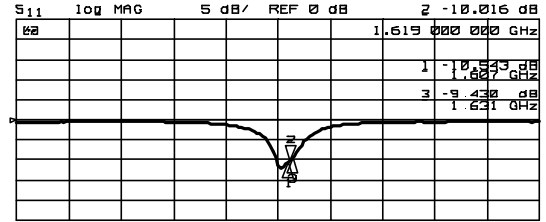

Condition
 $V_{LNA}=0V$
 $V_{MIX}=V_{LO}=2.7V$

IF OUT PORT IMPEDANCE

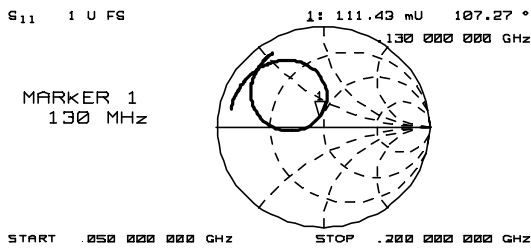
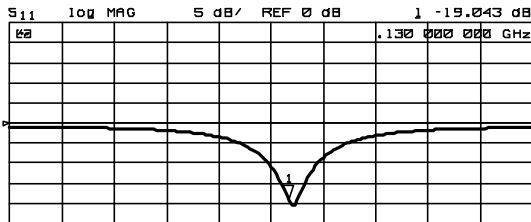

Condition
 $V_{LNA}=0V$
 $V_{MIX}=V_{LO}=2.7V$

■ TYPICAL CHARACTERISTICS 1 (LNA+MIXER, $f=1.5\text{GHz}$, $f_{LO}=1619\text{MHz}$, with test circuit 1)

RF IN – LOCAL IN ISOLATION
(RF IN → LOCAL IN)

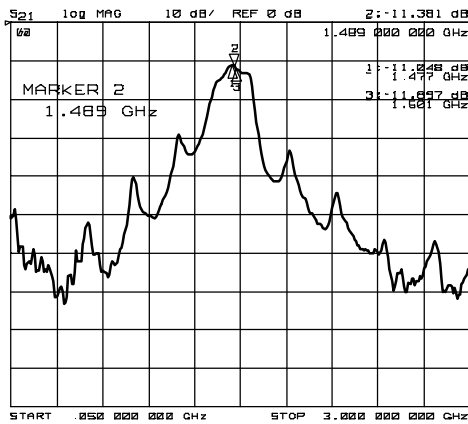

Condition

$V_{LNA}=2.7\text{V}$
 $V_{MIX}=V_{LO}=2.7\text{V}$
Port1:RF IN
Port2:LOCAL IN

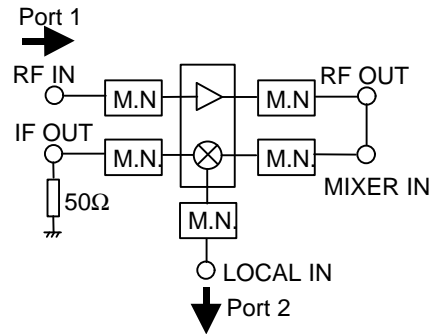

RF OUT – MIXER IN
Coaxial Cable
 $Z_0=50\text{ ohm}$, $L=260\text{ mm}$

RF OUT – MIXER IN ISOLATION
(RF OUT → MIXER IN)

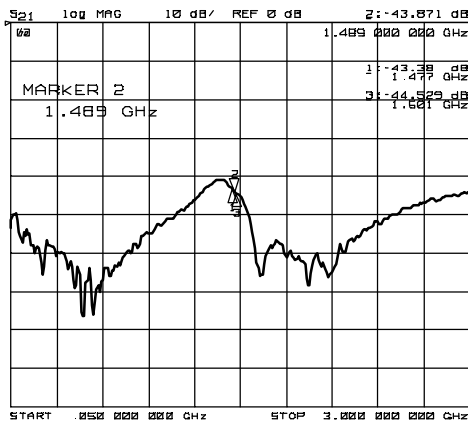

Condition

$V_{LNA}=2.7\text{V}$
 $V_{MIX}=V_{LO}=2.7\text{V}$
Port1:RF OUT
Port2:MIXER IN

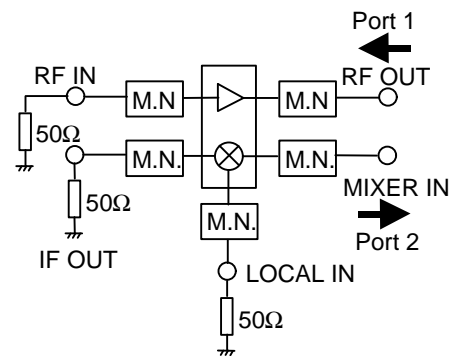

RF IN – IF OUT ISOLATION
(RF IN → IF OUT)

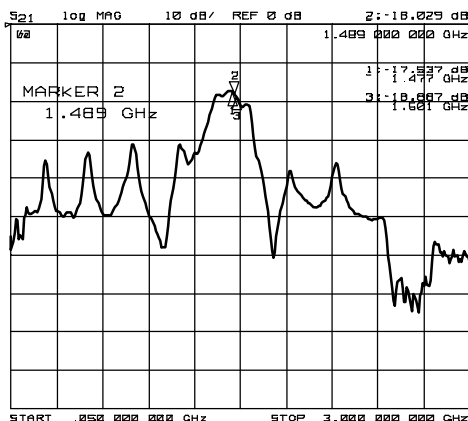

Condition

$V_{LNA}=2.7\text{V}$
 $V_{MIX}=V_{LO}=2.7\text{V}$
Port1:RF IN
Port2:IF OUT

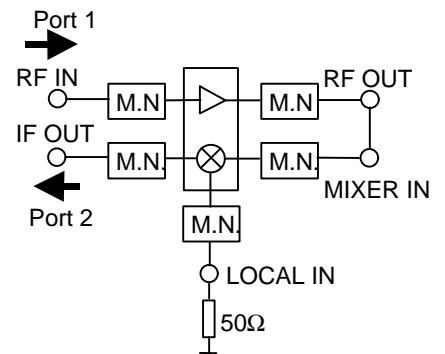

RF OUT – MIXER IN
Coaxial Cable
 $Z_0=50\text{ ohm}$, $L=260\text{ mm}$

NJG1709KC1

■ TYPICAL CHARACTERISTICS 1 (LNA+MIXER, $f=1.5\text{GHz}$, $f_{LO}=1619\text{MHz}$, with test circuit 1)

LOCAL IN to IF OUT Isolation vs. LO Frequency

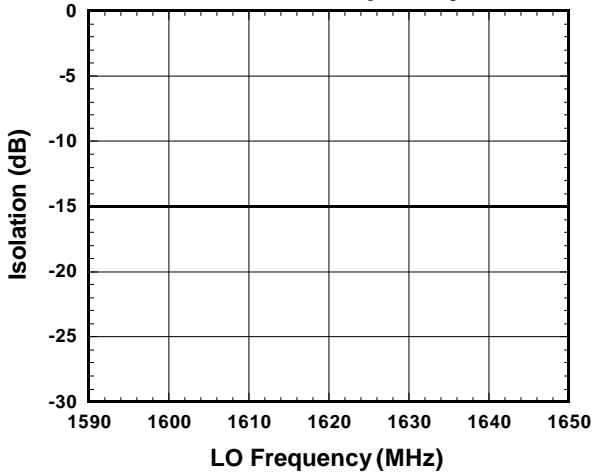

Condition
 $V_{LNA}=2.7\text{V}$
 $V_{MIX}=V_{LO}=2.7\text{V}$
 $P_{LO}=-15\text{dBm}$
 Port1: LOCAL IN
 Port2: IF OUT

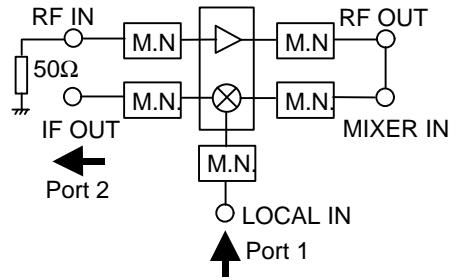

RF OUT – MIXER IN
 Coaxial Cable
 $Z_0=50\text{ ohm}$, $L=260\text{ mm}$

LOCAL IN to RF IN Isolation vs. LO Frequency

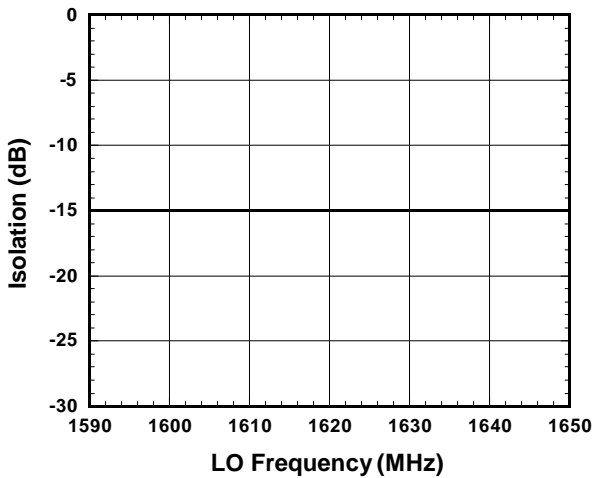

Condition
 $V_{LNA}=2.7\text{V}$
 $V_{MIX}=V_{LO}=2.7\text{V}$
 $P_{LO}=-15\text{dBm}$
 Port1: LOCAL IN
 Port2: RF IN

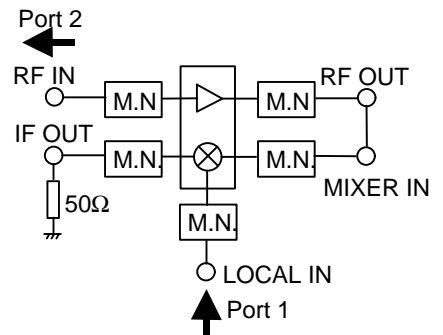

RF OUT – MIXER IN
 Coaxial Cable
 $Z_0=50\text{ ohm}$, $L=260\text{ mm}$

■ TYPICAL CHARACTERISTICS 2 (LNA, $f=1.9\text{GHz}$, $f_{LO}=1660\text{MHz}$, with test circuit 2)

Gain, NF vs. Frequency

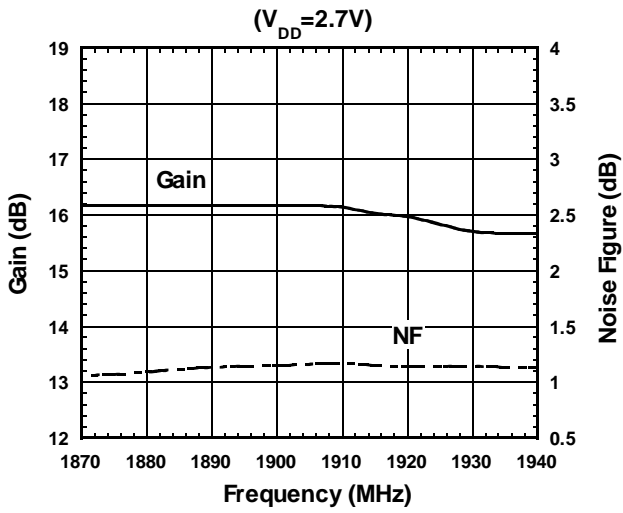

Pout vs. Pin

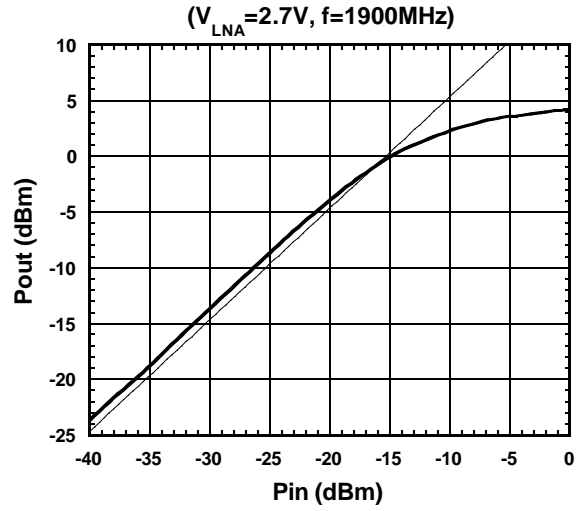

Pout, IM3 vs. Pin

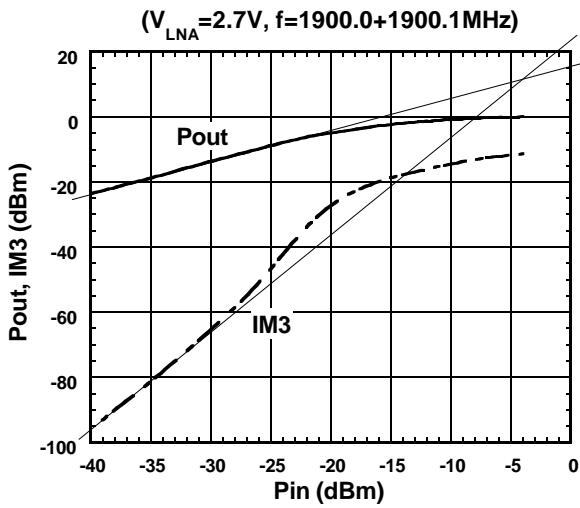

Gain, NF vs. V_{LNA}

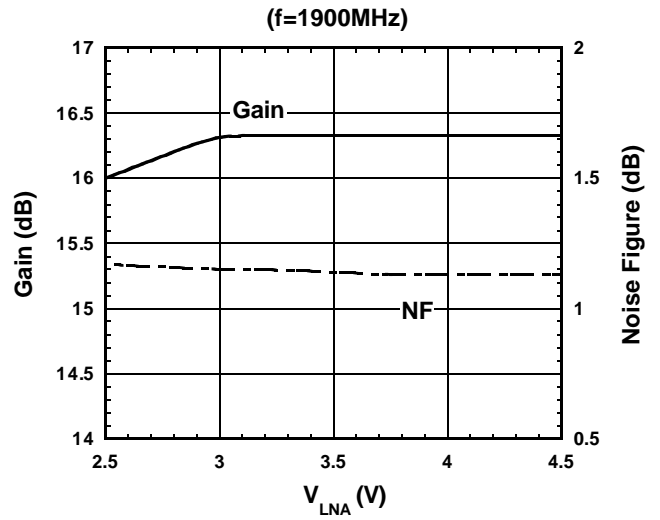

I_{LNA} vs. V_{LNA}

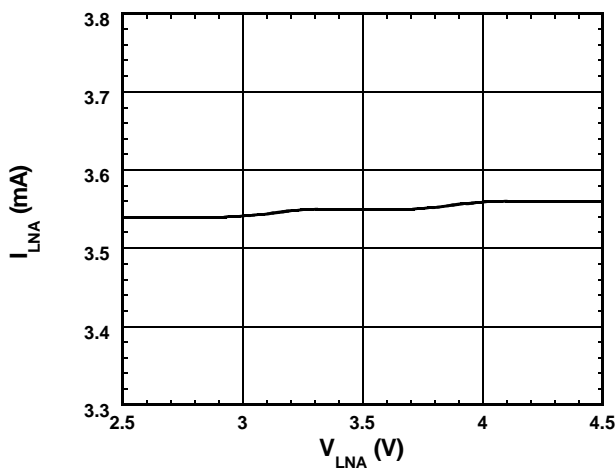

P-1dB vs. V_{LNA}

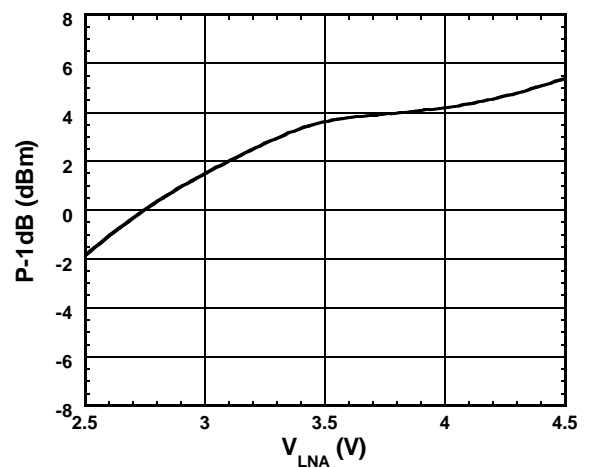

NJG1709KC1

■ TYPICAL CHARACTERISTICS 2 (LNA, f=1.9GHz, f_{LO}=1660MHz, with test circuit 2)

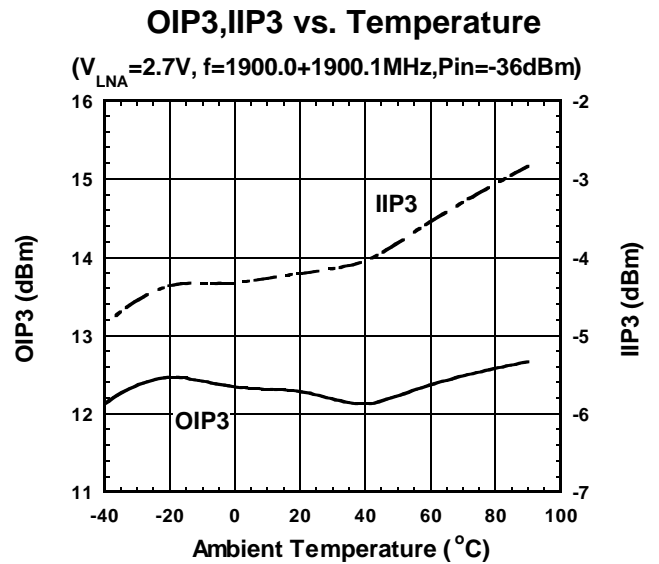
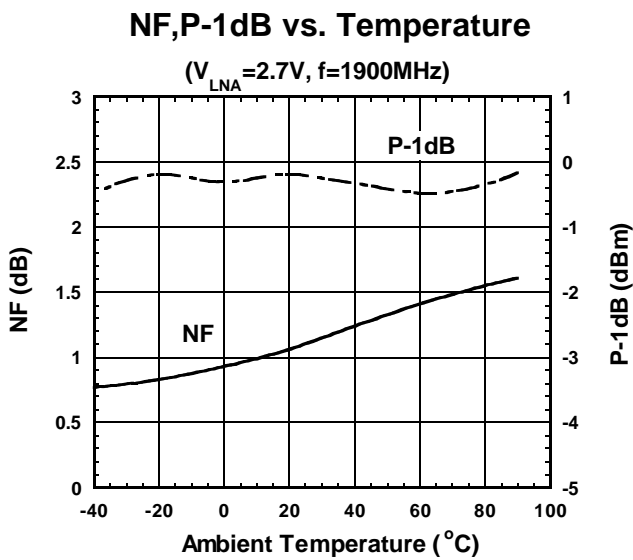
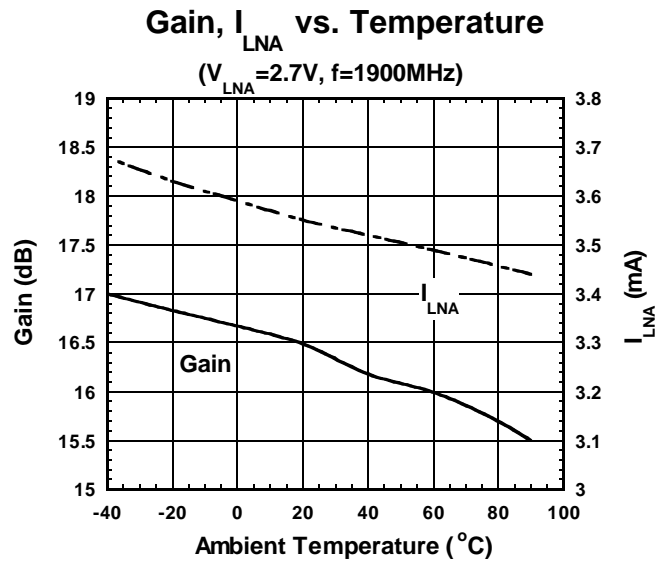
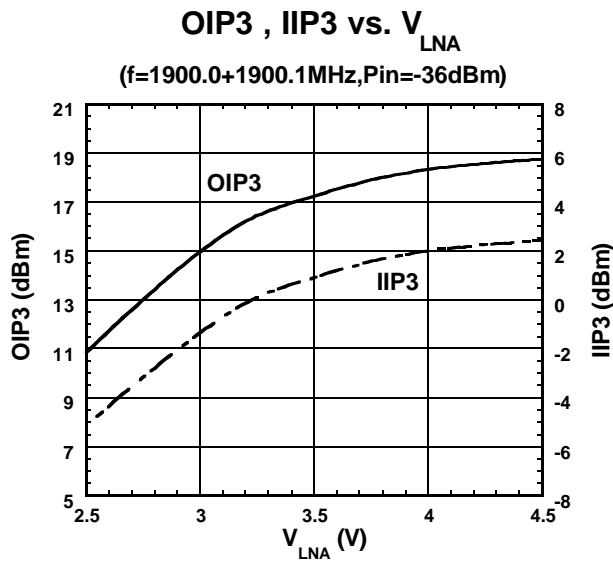

The value of OIP3 and IIP3 shown in typical characteristics are calculated

$$OIP3 = \frac{3 \times P_{out} - IM3}{2}$$

$$IIP3 = OIP3 - Gain \quad @ Pin = -36dBm$$

■ TYPICAL CHARACTERISTICS 2 (LNA, $f = 1.9\text{GHz}$, $f_{LO} = 1660\text{MHz}$, with test circuit 2)

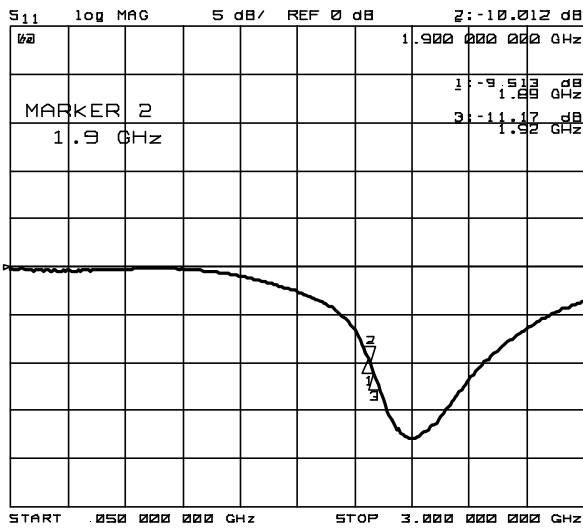

S11

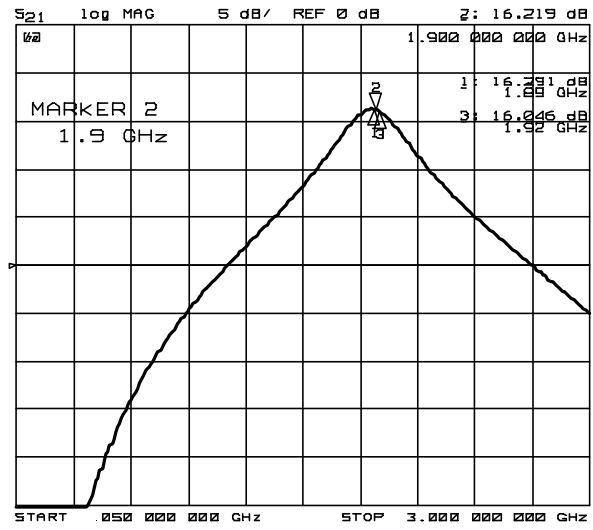

S21

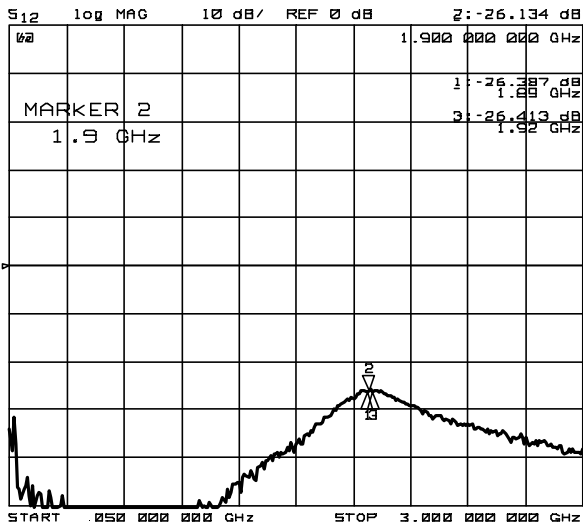

S12

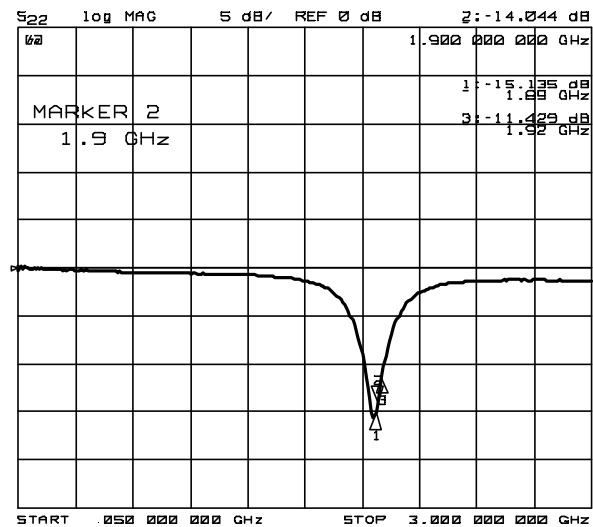

S22

Condition

$$V_{LNA} = 2.7\text{V}$$

$$V_{MIX} = V_{LO} = 0\text{V}$$

NJG1709KC1

■ TYPICAL CHARACTERISTICS 2 (MIXER, $f=1.9\text{GHz}$, $f_{LO}=1660\text{MHz}$, with test circuit 2)

Conversion Gain, Noise Figure vs. RF Frequency

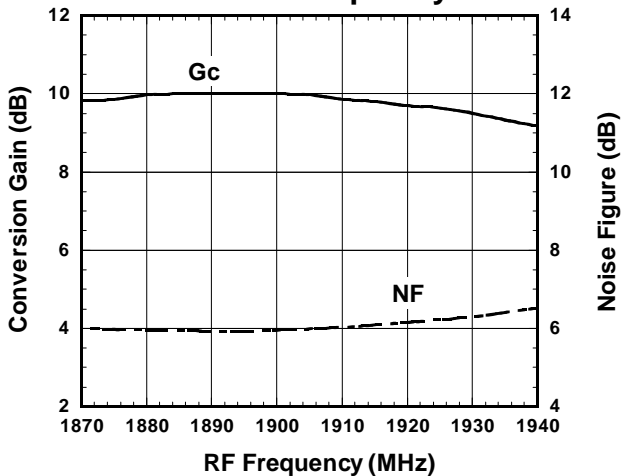

Condition
 $f_{IF}=240\text{MHz}$
 $P_{RF}=-30\text{dBm}$
 $P_{LO}=-15\text{dBm}$
 $V_{MIX}=V_{LO}=2.7\text{V}$
 Upper LOCAL

Conversion Gain, Noise Figure vs. LO Power

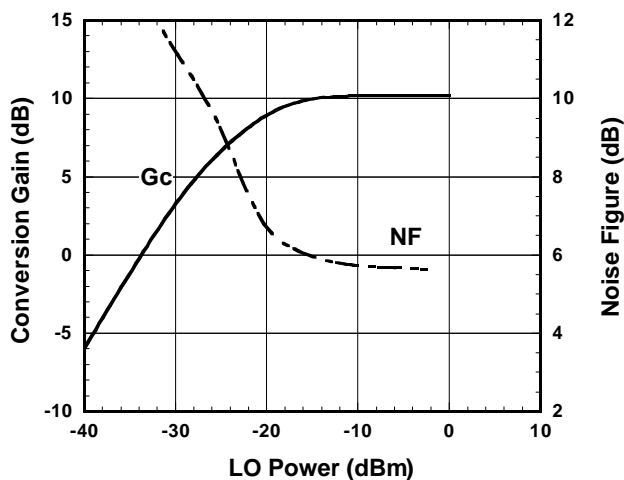

Condition
 $f_{IF}=240\text{MHz}$
 $f_{RF}=1900\text{MHz}$, $P_{RF}=-30\text{dBm}$
 $f_{LO}=1660\text{MHz}$
 $V_{MIX}=V_{LO}=2.7\text{V}$

OIP3, IIP3 vs. LO Power

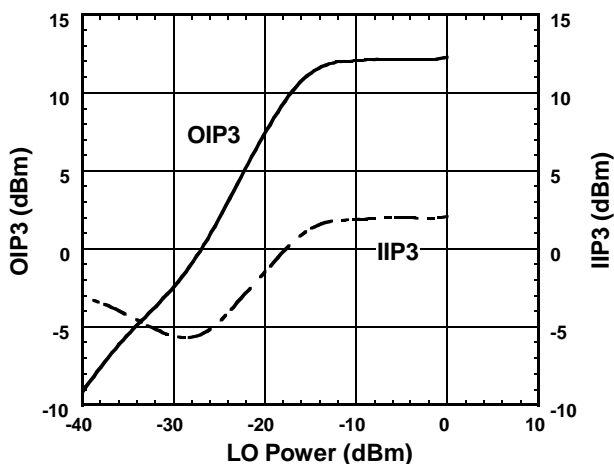

Condition
 $f_{IF}=240\text{MHz}$
 $f_{RF1}=1900.0\text{MHz}$, $P_{RF}=-30\text{dBm}$
 $f_{RF2}=1900.1\text{MHz}$
 $f_{LO}=1660\text{MHz}$
 $V_{MIX}=V_{LO}=2.7\text{V}$

$$\text{OIP3} = \frac{3 \times \text{IF} - \text{IM3}}{2}$$

$$\text{IIP3} = \text{OIP3} - G_c$$

@ $P_{RF} = -30\text{dBm}$

■ TYPICAL CHARACTERISTICS 2 (MIXER, $f=1.9\text{GHz}$, $f_{LO}=1660\text{MHz}$, with test circuit 2)

Conversion Gain, Noise Figure
vs. V_{MIX} , V_{LO}

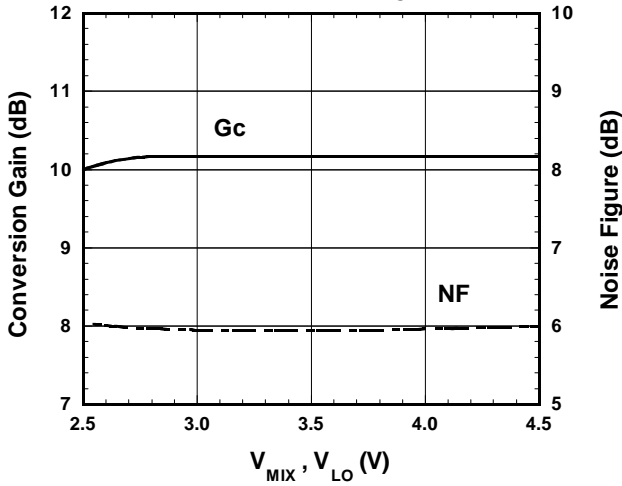

Condition

$f_{IF}=240\text{MHz}$
 $f_{RF}=1900\text{MHz}$, $P_{RF}=-30\text{dBm}$
 $f_{LO}=1660\text{MHz}$, $P_{LO}=-15\text{dBm}$

OIP3, IIP3 vs. V_{MIX} , V_{LO}

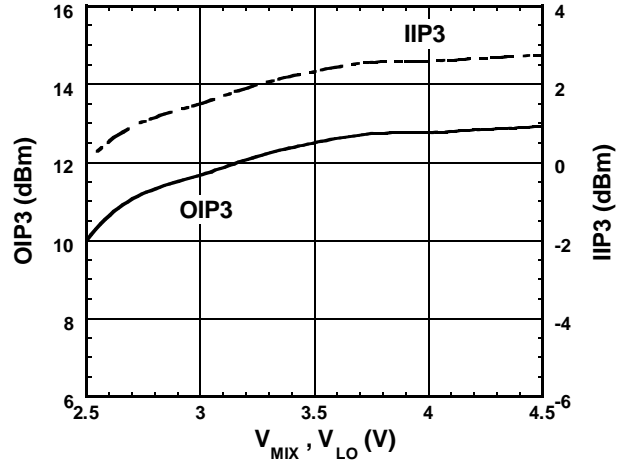

Condition

$f_{IF}=240\text{MHz}$
 $f_{RF1}=1900.0\text{MHz}$, $P_{RF}=-30\text{dBm}$
 $f_{RF2}=1900.1\text{MHz}$
 $f_{LO}=1660\text{MHz}$, $P_{LO}=-15\text{dBm}$

$OIP3 = \frac{3 \times IF - IM3}{2}$
 $IIP3 = OIP3 - Gc$
 @ $P_{RF} = -30\text{dBm}$

IF, IM3 vs. RF Power

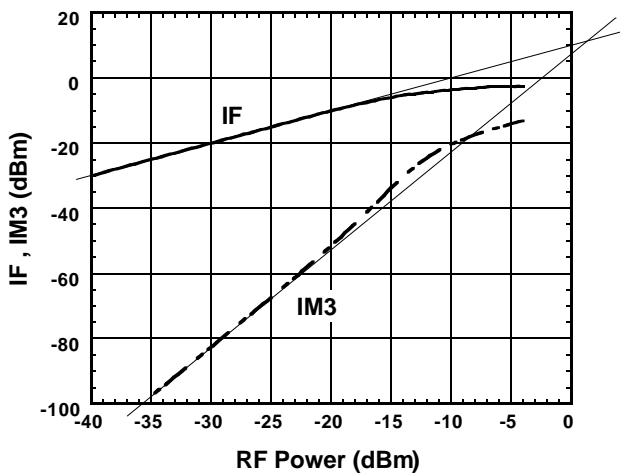

Condition

$f_{IF}=240\text{MHz}$
 $f_{RF1}=1900.0\text{MHz}$
 $f_{RF2}=1900.1\text{MHz}$
 $f_{LO}=1660\text{MHz}$, $P_{LO}=-15\text{dBm}$
 $V_{MIX}=V_{LO}=2.7\text{V}$

IF Output Power vs. RF Power

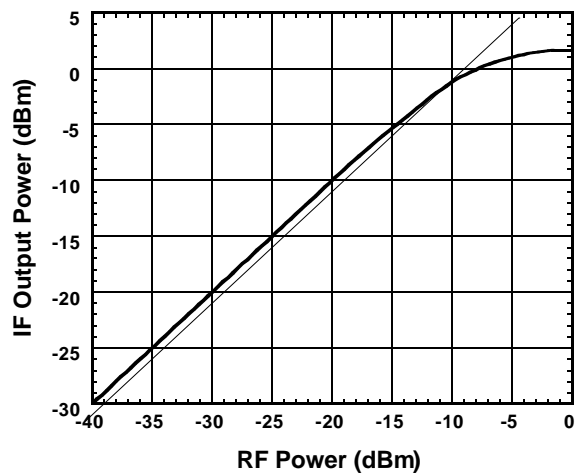

Condition

$f_{IF}=240\text{MHz}$
 $f_{RF}=1900\text{MHz}$
 $f_{LO}=1660\text{MHz}$, $P_{LO}=-15\text{dBm}$
 $V_{MIX}=V_{LO}=2.7\text{V}$

NJG1709KC1

■ TYPICAL CHARACTERISTICS 2 (MIXER, $f=1.9\text{GHz}$, $f_{LO}=1660\text{MHz}$, with test circuit 2)

**Conversion Gain vs. LO Power
Temperature Response**

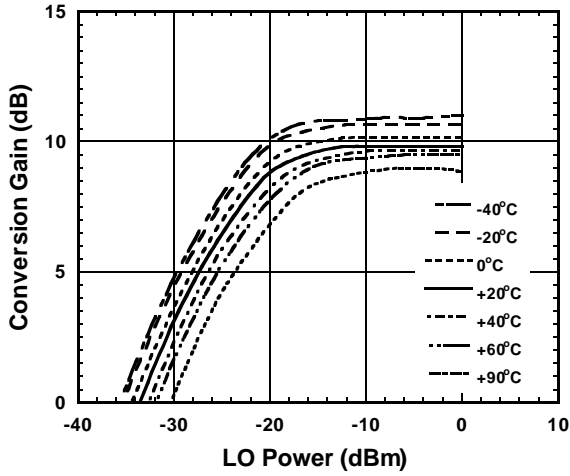

Condition
 $f_{IF}=240\text{MHz}$
 $f_{RF}=1900\text{MHz}$, $P_{RF}=-30\text{dBm}$
 $f_{LO}=1660\text{MHz}$
 $V_{MIX}=V_{LO}=2.7\text{V}$

**Noise Figure vs. LO Power
Temperature Response**

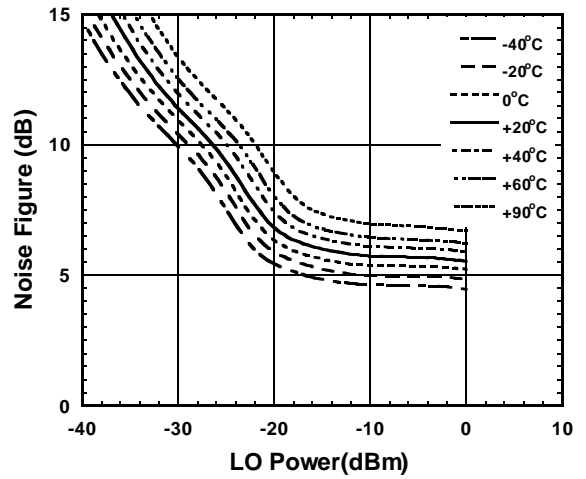

Condition
 $f_{IF}=240\text{MHz}$
 $f_{RF}=1900\text{MHz}$
 $f_{LO}=1660\text{MHz}$
 $V_{MIX}=V_{LO}=2.7\text{V}$

**IIP3 vs. LO Power
Temperature Response**

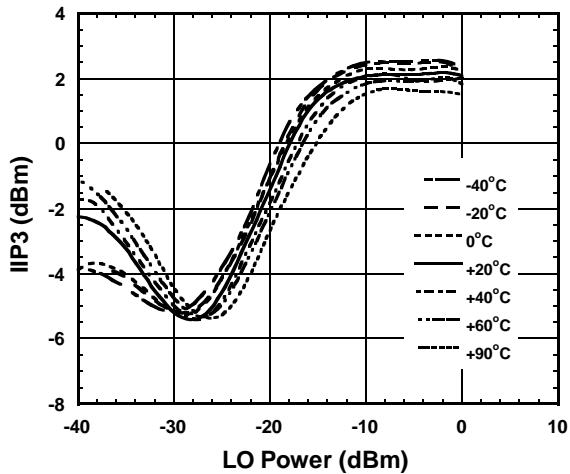

Condition
 $f_{IF}=240\text{MHz}$
 $f_{RF1}=1900.0\text{MHz}$, $P_{RF}=-30\text{dBm}$
 $f_{RF2}=1900.1\text{MHz}$
 $f_{LO}=1660\text{MHz}$
 $V_{MIX}=V_{LO}=2.7\text{V}$

$$IIP3 = \frac{3 \times IF - IM3}{2} - G_c$$

@ $P_{RF} = -30\text{dBm}$

■ TYPICAL CHARACTERISTICS 2 (MIXER, $f=1.9\text{GHz}$, $f_{LO}=1660\text{MHz}$, with test circuit 2)

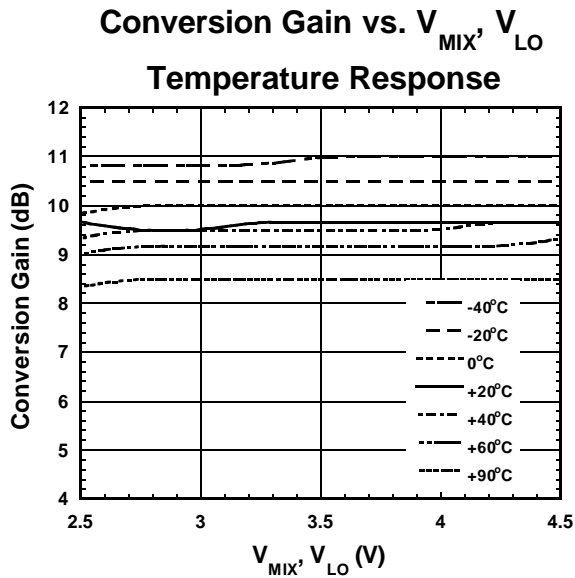

Condition
 $f_{IF}=240\text{MHz}$
 $f_{RF}=1900\text{MHz}$, $P_{RF}=-30\text{dBm}$
 $f_{LO}=1660\text{MHz}$, $P_{LO}=-15\text{dBm}$

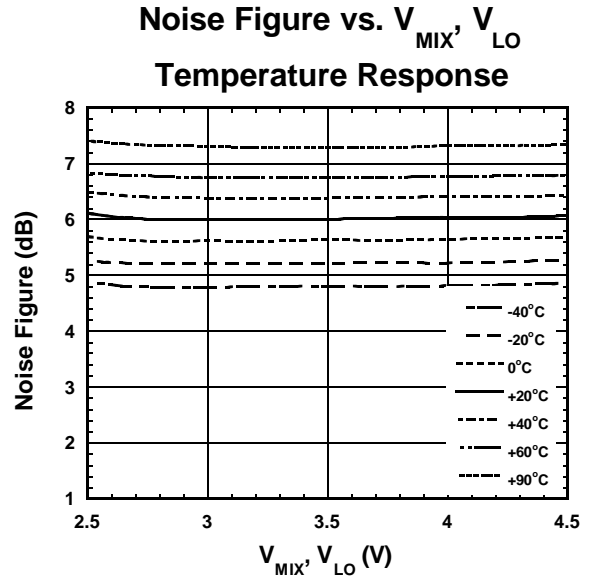

Condition
 $f_{IF}=240\text{MHz}$
 $f_{RF}=1900\text{MHz}$
 $f_{LO}=1660\text{MHz}$, $P_{LO}=-15\text{dBm}$

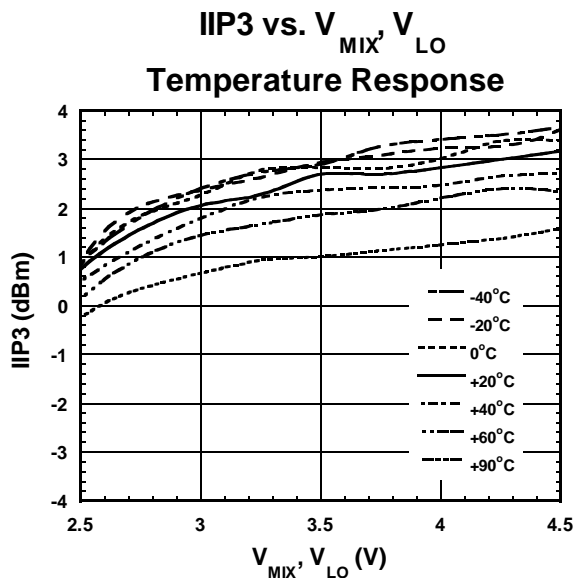

Condition
 $f_{IF}=240\text{MHz}$
 $f_{RF1}=1900.0\text{MHz}$, $P_{RF}=-30\text{dBm}$
 $f_{RF2}=1900.1\text{MHz}$
 $f_{LO}=1660\text{MHz}$, $P_{LO}=-15\text{dBm}$

$$IIP3 = \frac{3 \times IF - IM3}{2} - GC$$

@ $P_{RF} = -30\text{dBm}$

NJG1709KC1

■ TYPICAL CHARACTERISTICS 2 (MIXER, $f=1.9\text{GHz}$, $f_{LO}=1660\text{MHz}$, with test circuit 2)

MIXER IN PORT IMPEDANCE

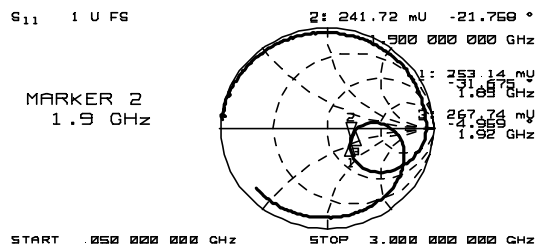
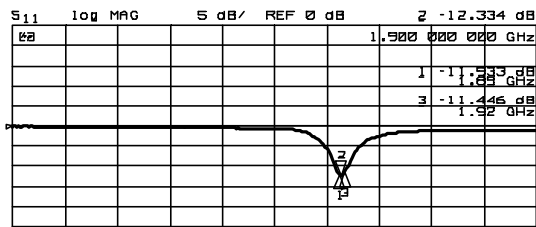

Condition
 $V_{LNA}=0V$
 $V_{MIX}=V_{LO}=2.7V$

LOCAL IN PORT IMPEDANCE

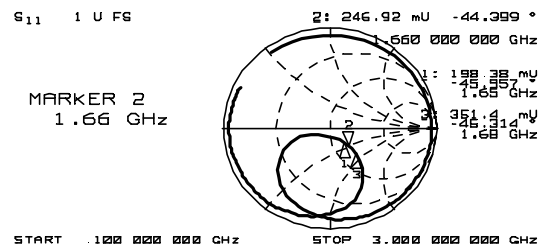
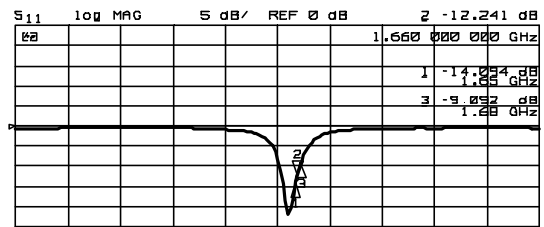

Condition
 $V_{LNA}=0V$
 $V_{MIX}=V_{LO}=2.7V$

IF OUT PORT IMPEDANCE

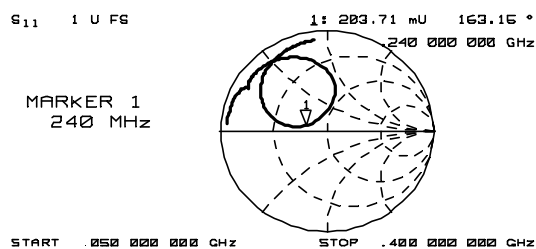
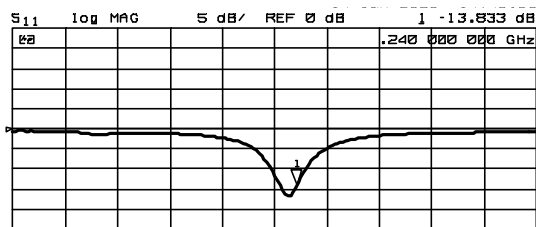

Condition
 $V_{LNA}=0V$
 $V_{MIX}=V_{LO}=2.7V$

■ TYPICAL CHARACTERISTICS 2 (LNA+MIXER $f=1.9\text{GHz}$, $f_{LO}=1660\text{MHz}$, with test circuit 2)

RF IN – LOCAL IN ISOLATION
(RF IN → LOCAL IN)

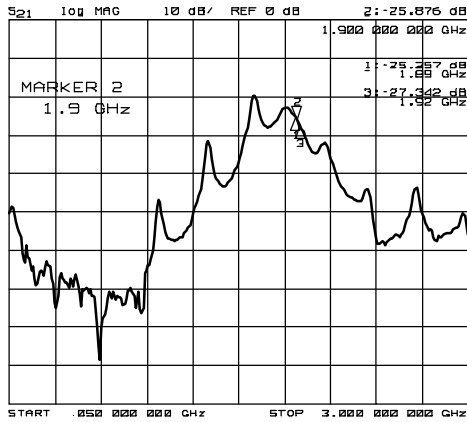

Condition

$V_{LNA}=2.7\text{V}$
 $V_{MIX}=V_{LO}=2.7\text{V}$
 Port1:RF IN
 Port2:LOCAL IN

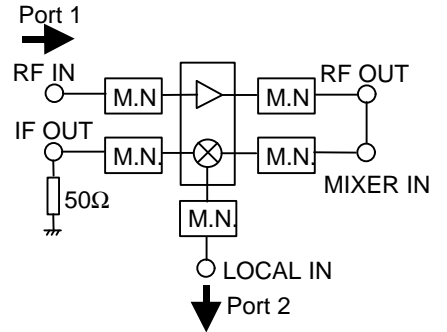

RF OUT – MIXER IN
 Coaxial Cable
 $Z_0=50\text{ ohm}$, $L=260\text{ mm}$

RF OUT – MIXER IN ISOLATION
(RF OUT → MIXER IN)

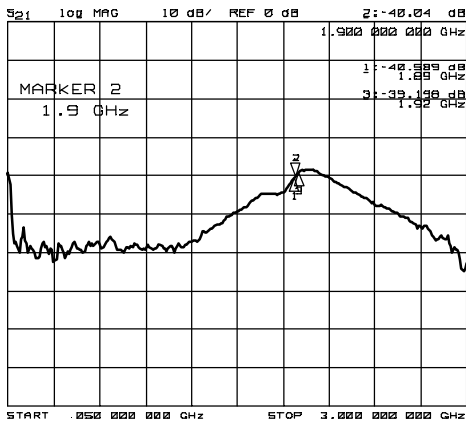

Condition

$V_{LNA}=2.7\text{V}$
 $V_{MIX}=V_{LO}=2.7\text{V}$
 Port1:RF OUT
 Port2:MIXER IN

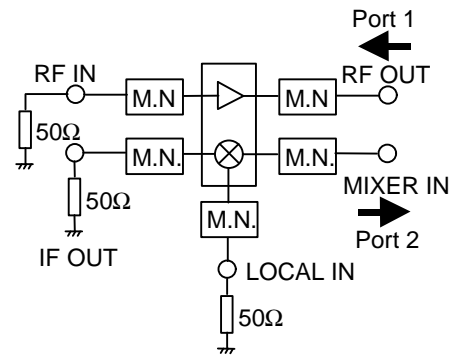

RF IN – IF OUT ISOLATION
(RF IN → IF OUT)

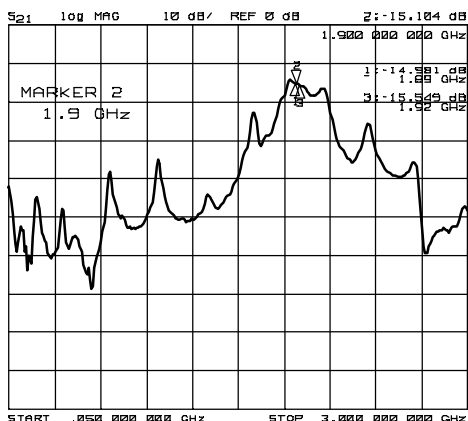

Condition

$V_{LNA}=2.7\text{V}$
 $V_{MIX}=V_{LO}=2.7\text{V}$
 Port1:RF IN
 Port2:IF OUT

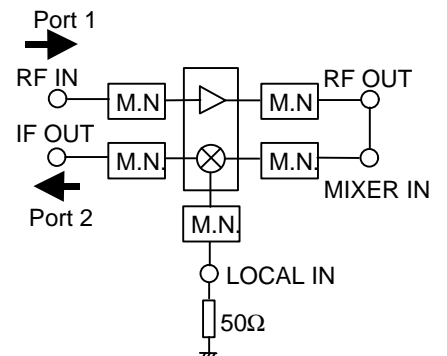

RF OUT – MIXER IN
 Coaxial Cable
 $Z_0=50\text{ ohm}$, $L=260\text{ mm}$

NJG1709KC1

■ TYPICAL CHARACTERISTICS 2 (LNA+MIXER, $f=1.9\text{GHz}$, $f_{LO}=1660\text{MHz}$, with test circuit 2)

LOCAL IN to IF OUT Isolation vs. LO Frequency

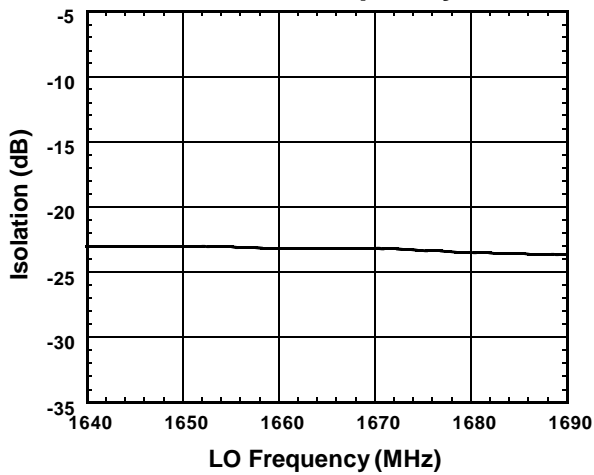

Condition
 $V_{LNA}=2.7\text{V}$
 $V_{MIX}=V_{LO}=2.7\text{V}$
 $P_{LO}=-15\text{dBm}$
 Port1: LOCAL IN
 Port2: IF OUT

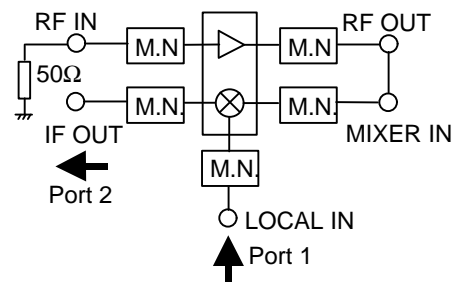

RF OUT – MIXER IN
 Coaxial Cable
 $Z_0=50\text{ ohm}$, $L=260\text{ mm}$

LOCAL IN to RF IN Isolation vs. LO Frequency

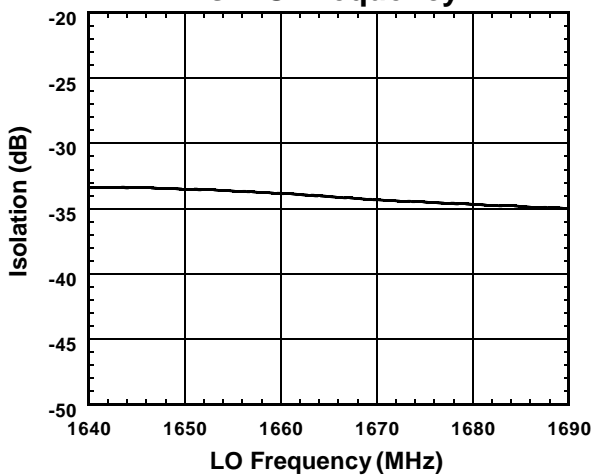

Condition
 $V_{LNA}=2.7\text{V}$
 $V_{MIX}=V_{LO}=2.7\text{V}$
 $P_{LO}=-15\text{dBm}$
 Port1: LOCAL IN
 Port2: RF IN

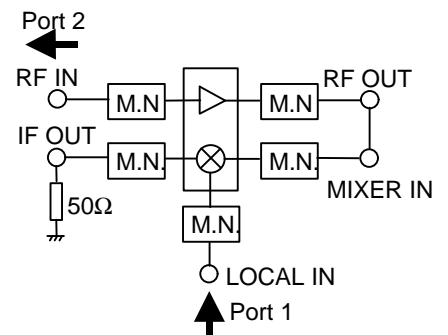

RF OUT – MIXER IN
 Coaxial Cable
 $Z_0=50\text{ ohm}$, $L=260\text{ mm}$

TEST CIRCUIT 1 (1.5GHz BAND)

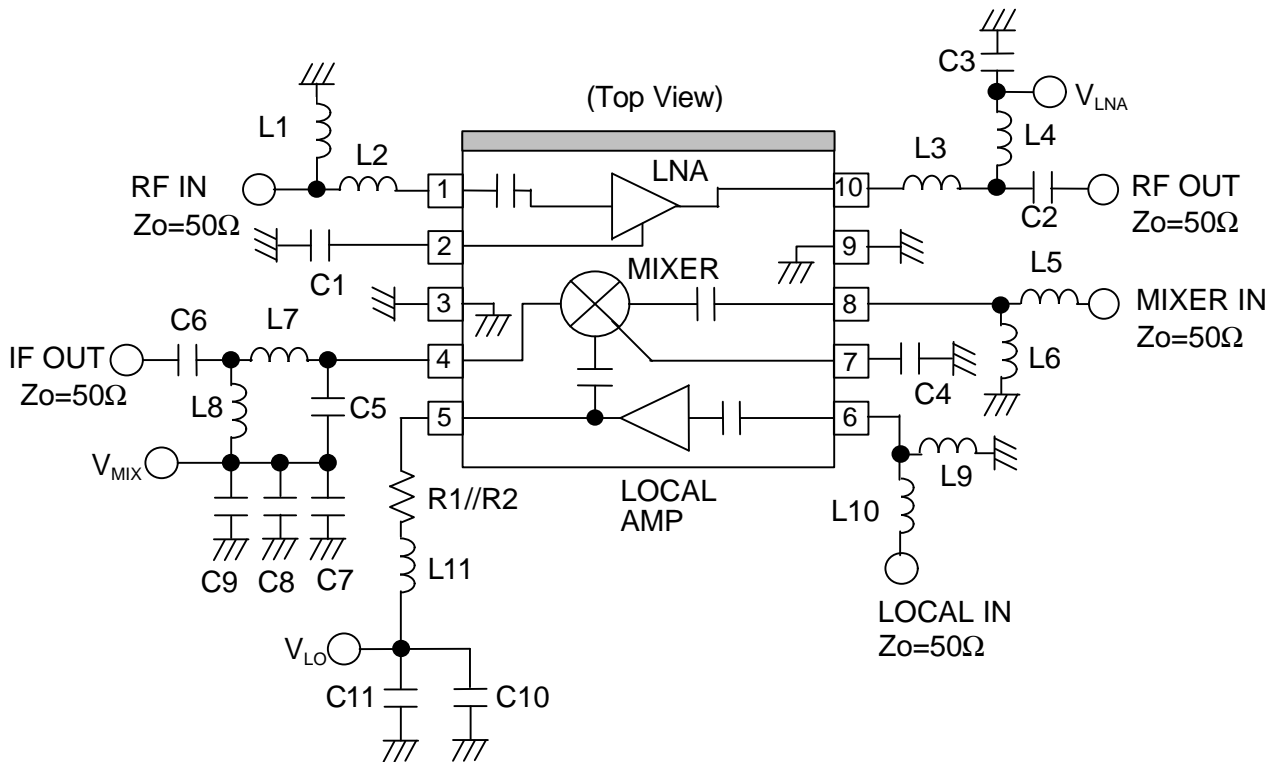

TEST CIRCUIT 2 (1.9GHz BAND)

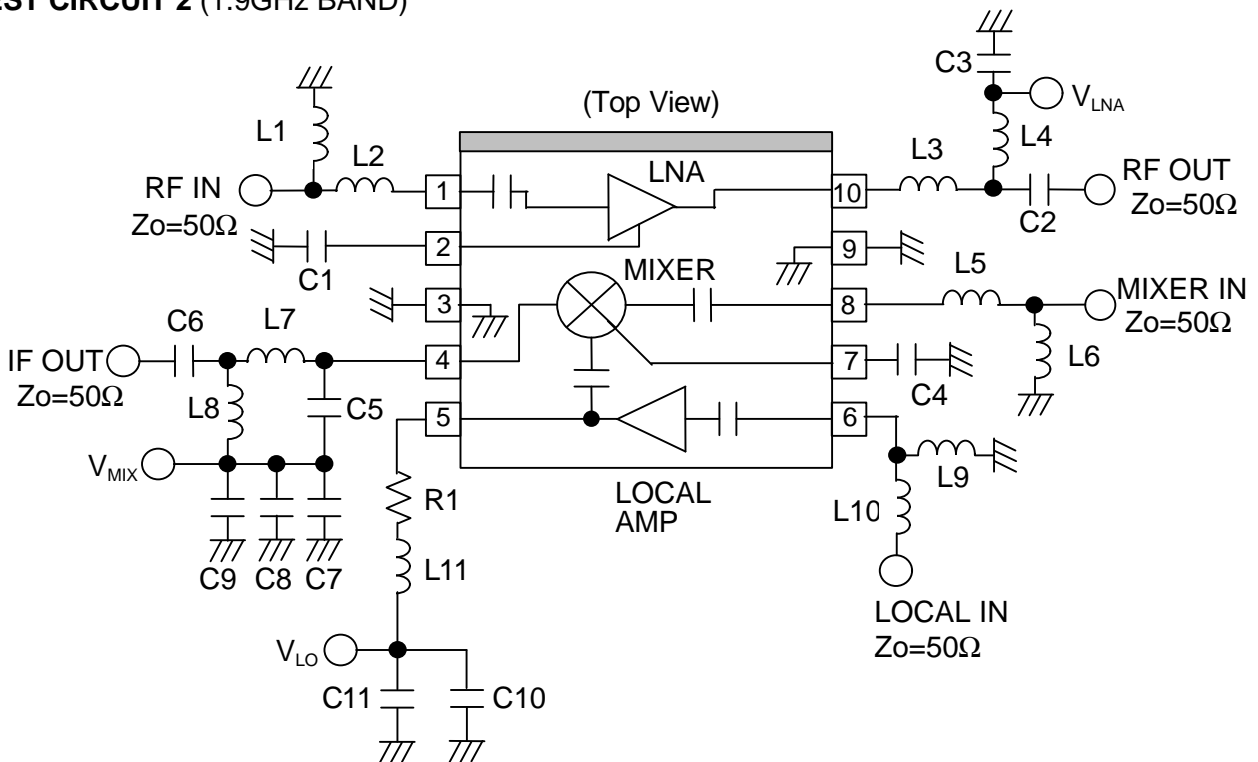

NJG1709KC1

■TEST CIRCUIT

PARTS LIST

PART ID	1.5GHz BAND	1.9GHz BAND	COMMENT
	Upper LOCAL	Lower LOCAL	
	$f_{LO}=1619\text{MHz}$ $P_{LO}=-15\text{dBm}$ $f_{IF}=130\text{MHz}$	$f_{LO}=1660\text{MHz}$ $P_{LO}=-15\text{dBm}$ $f_{IF}=240\text{MHz}$	
L1	12nH	10nH	TAIYO-YUDEN (HK1005)
L2	12nH	6.8nH	TAIYO-YUDEN (HK1005)
L3	10nH	5.6nH	TAIYO-YUDEN (HK1005)
L4	2.7nH	1.5nH	TAIYO-YUDEN (HK1005)
L5	18nH	3.9nH	TAIYO-YUDEN (HK1005)
L6	15nH	1.2nH	TAIYO-YUDEN (HK1005)
L7	82nH	47nH	TAIYO-YUDEN (HK1608)
L8	33nH	18nH	TAIYO-YUDEN (HK1005)
L9	22nH	18nH	TAIYO-YUDEN (HK1005)
L10	15nH	18nH	TAIYO-YUDEN (HK1005)
L11	8.2nH	8.2nH	TAIYO-YUDEN (HK1005)
C1	30pF	7pF	MURATA (GRM36)
C2	39pF	12pF	MURATA (GRM36)
C3	1000pF	1000pF	MURATA (GRM36)
C4	1000pF	1000pF	MURATA (GRM36)
C5	12pF	6pF	MURATA (GRM36)
C6	1000pF	1000pF	MURATA (GRM36)
C7	10pF	10pF	MURATA (GRM36)
C8	100pF	100pF	MURATA (GRM36)
C9	1000pF	1000pF	MURATA (GRM36)
C10	10pF	10pF	MURATA (GRM36)
C11	100pF	100pF	MURATA (GRM36)
R1	18Ω	10Ω	CHIP SIZE 1005
R2	18Ω	-	CHIP SIZE 1005

RECOMMENDED PCB DESIGN

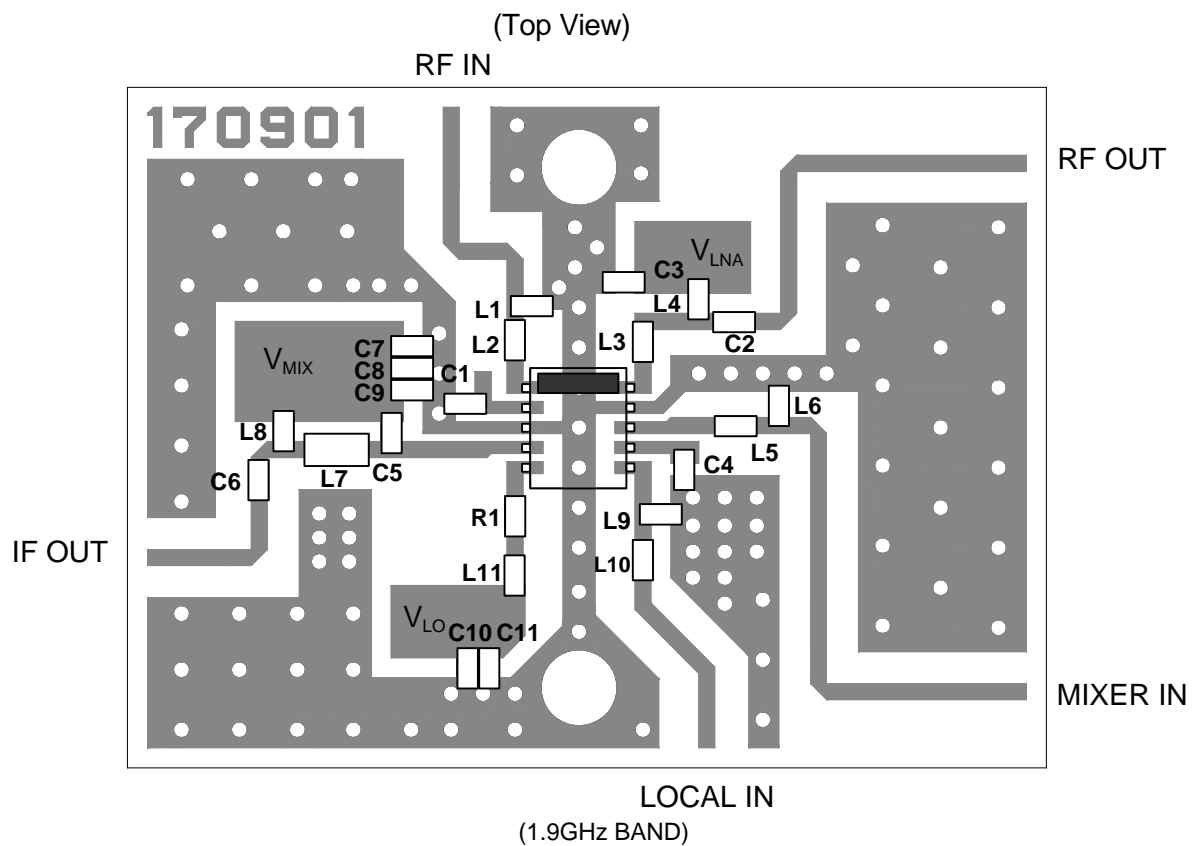
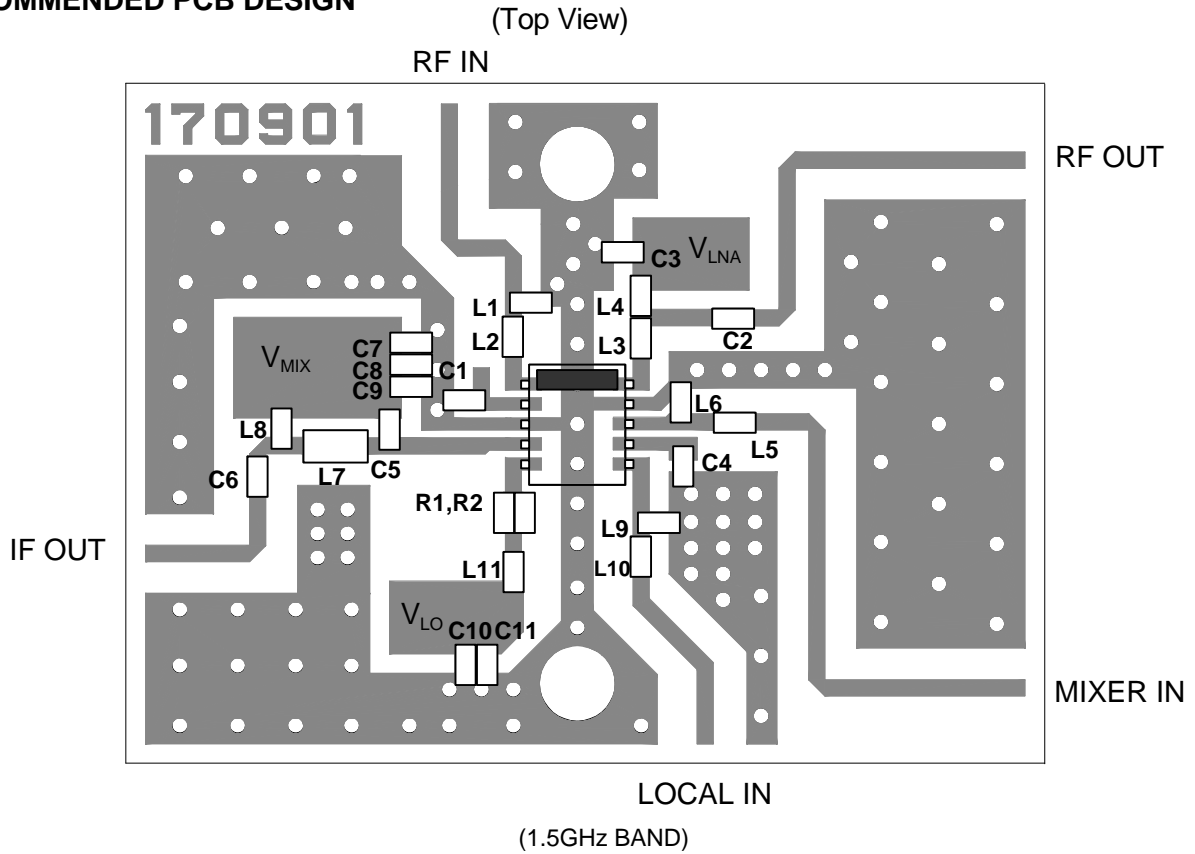

PCB (FR-4) : $t = 0.2 \text{ mm}$

MICROSTRIP LINE WIDTH = 0.4 mm ($Z_0 = 50\Omega$)

PCB SIZE = $23.0 \times 17.0 \text{ mm}$

New Japan Radio Co., Ltd.

MEASURING BLOCK DIAGRAM

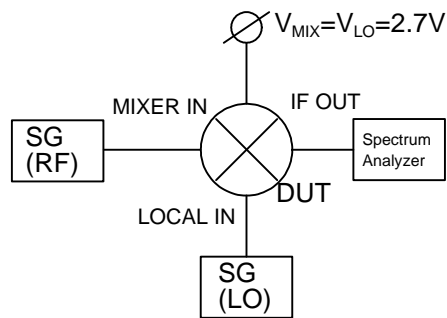

Conversion Gain Measuring Block Diagram

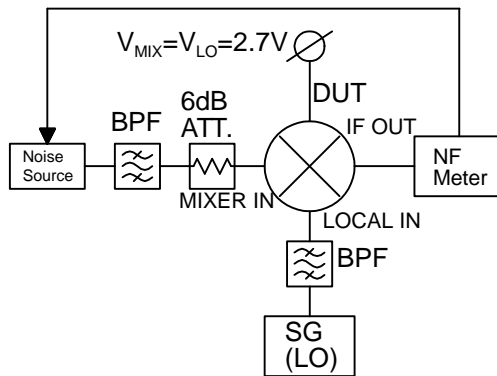

Noise Figure Measuring Block Diagram

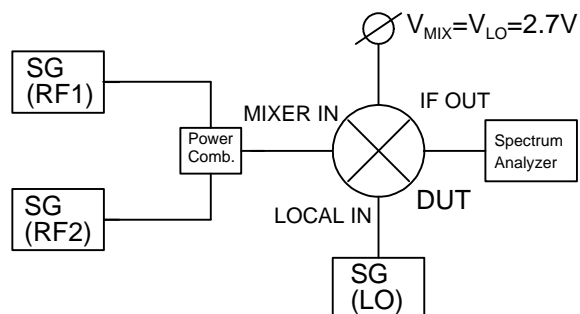

IF, IM3 Measuring Block Diagram

PACKAGE OUTLINE (FLP10-C1)

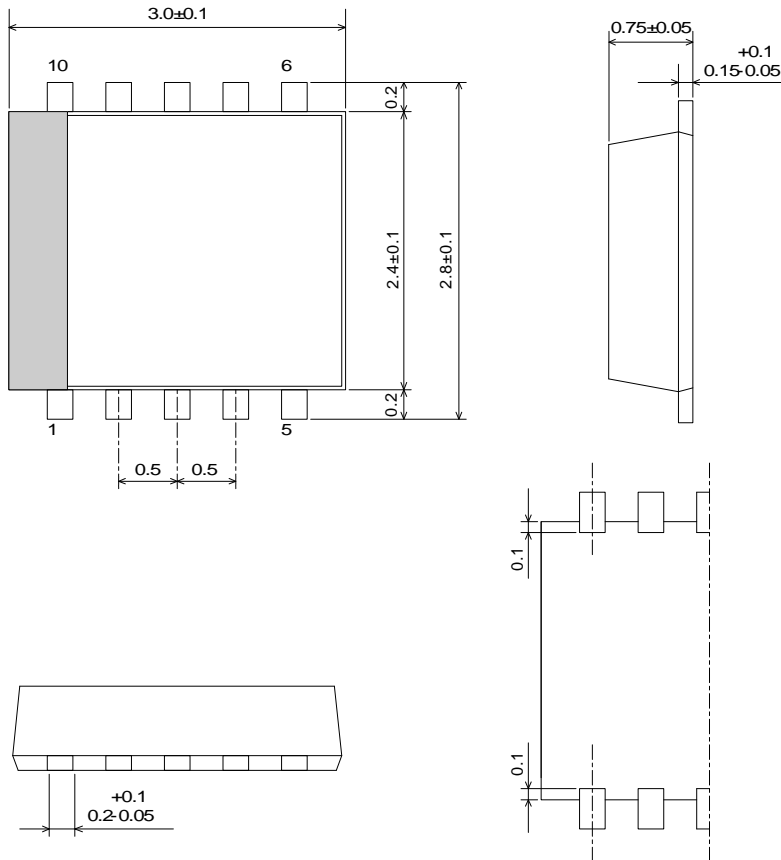

Lead material	: Copper
Lead surface finish	: Solder plating
Molding material	: Epoxy resin
UNIT	: mm
Weight	: 15mg

Cautions on using this product

This product contains Gallium-Arsenide (GaAs) which is a harmful material.

- Do NOT eat or put into mouth.
- Do NOT dispose in fire or break up this product.
- Do NOT chemically make gas or powder with this product.
- To waste this product, please obey the relating law of your country.

[CAUTION]

The specifications on this databook are only given for information, without any guarantee as regards either mistakes or omissions. The application circuits in this databook are described only to show representative usages of the product and not intended for the guarantee or permission of any right including the industrial rights.

This product may be damaged with electric static discharge (ESD) or spike voltage. Please handle with care to avoid these damages.



Компания «ЭлектроПласт» предлагает заключение долгосрочных отношений при поставках импортных электронных компонентов на взаимовыгодных условиях!

Наши преимущества:

- Оперативные поставки широкого спектра электронных компонентов отечественного и импортного производства напрямую от производителей и с крупнейших мировых складов;
- Поставка более 17-ти миллионов наименований электронных компонентов;
- Поставка сложных, дефицитных, либо снятых с производства позиций;
- Оперативные сроки поставки под заказ (от 5 рабочих дней);
- Экспресс доставка в любую точку России;
- Техническая поддержка проекта, помощь в подборе аналогов, поставка прототипов;
- Система менеджмента качества сертифицирована по Международному стандарту ISO 9001;
- Лицензия ФСБ на осуществление работ с использованием сведений, составляющих государственную тайну;
- Поставка специализированных компонентов (Xilinx, Altera, Analog Devices, Intersil, Interpoint, Microsemi, Aeroflex, Peregrine, Syfer, Eurofarad, Texas Instrument, Miteq, Cobham, E2V, MA-COM, Hittite, Mini-Circuits, General Dynamics и др.);

Помимо этого, одним из направлений компании «ЭлектроПласт» является направление «Источники питания». Мы предлагаем Вам помощь Конструкторского отдела:

- Подбор оптимального решения, техническое обоснование при выборе компонента;
- Подбор аналогов;
- Консультации по применению компонента;
- Поставка образцов и прототипов;
- Техническая поддержка проекта;
- Защита от снятия компонента с производства.



Как с нами связаться

Телефон: 8 (812) 309 58 32 (многоканальный)

Факс: 8 (812) 320-02-42

Электронная почта: org@eplast1.ru

Адрес: 198099, г. Санкт-Петербург, ул. Калинина, дом 2, корпус 4, литера А.