



## MIC44F18/19/20

6A, 13V High Speed MOSFET Drivers  
with Enable Input

### General Description

The MIC44F18, MIC44F19 and MIC44F20 are high-speed single MOSFET drivers capable of sinking and sourcing 6A for driving capacitive loads. With delay times of less than 15ns and rise times into a 1000pF load of 10ns, these MOSFET drivers are ideal for driving large gate charge MOSFETs in power supply applications. The MIC44F18 is a non-inverting driver, the MIC44F19 is an inverting driver suited for driving P-Channel MOSFETs and the MIC44F20 is an inverting driver for N-Channel MOSFETs.

Fabricated using Micrel's proprietary BiCMOS/DMOS process for low power consumption and high efficiency, the MIC44F18/19/20 translates TTL or CMOS input logic levels to output voltage levels that swing within 25mV of the positive supply or ground. Comparable bipolar devices are capable of swinging only to within 1V of the supply.

The input supply voltage range of the MIC44F18/19/20 is 4.5V to 13.2V, making the devices suitable for driving MOSFETs in a wide range of power applications. Other features include an enable function, latch-up protection, and a programmable UVLO function.

The MIC44F18/19/20 has a junction temperature range of  $-40^{\circ}\text{C}$  to  $+125^{\circ}\text{C}$  with exposed pad ePAD MSOP-8 and 2mm x 2mm MLF<sup>®</sup>-8 package options.

Data sheets and support documentation can be found on Micrel's web site at: [www.micrel.com](http://www.micrel.com).

### Features

- 4.5V to 13.2V input operating range
- 6A peak output current
- High accuracy  $\pm 5\%$  enable input threshold
- High speed switching capability
  - 10ns rise time in 1000pF load
  - $<15\text{ns}$  propagation delay time
- Flexible UVLO function
  - 4.2V internally set UVLO
  - Programmable with external resistors
- Latch-up protection to  $>500\text{mA}$  reverse current on the output pin
- Enable function
- Thermally enhanced ePAD MSOP-8 package option
- Miniature 2mm x 2mm MLF<sup>®</sup>-8 package option
- Pb-free packaging

### Applications

- Synchronous switch-mode power supplies
- Secondary side synchronous rectification

### Typical Applications

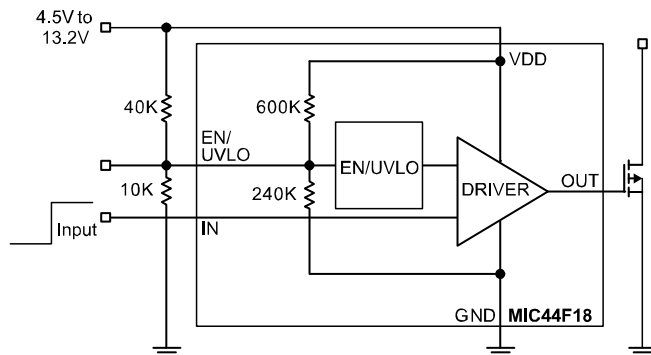

MOSFET Driver with 6.2V UVLO Externally Set

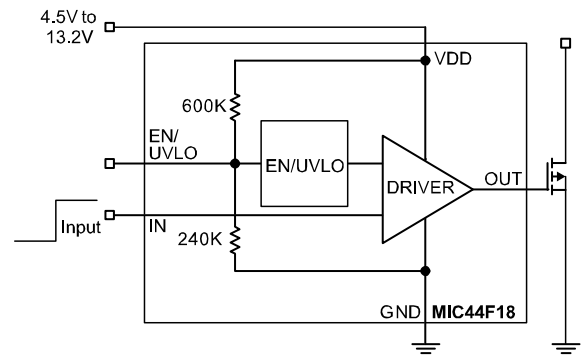

MOSFET Driver with 4.2V UVLO Internally Set

MLF and MicroLeadFrame are registered trademarks of Amkor Technologies, Inc.

Micrel Inc. • 2180 Fortune Drive • San Jose, CA 95131 • USA • tel +1 (408) 944-0800 • fax + 1 (408) 474-1000 • <http://www.micrel.com>

## Ordering Information

Part Number	Marking	Configuration	Junction Temp. Range	Package	Lead Finish
MIC44F18YML	$\overline{D12}$	Non-Inverting	-40°C to 125°C	2x2 MLF-8	Pb-Free
MIC44F18YMME		Non-Inverting	-40°C to 125°C	ePAD MSOP-8	Pb-Free
MIC44F19YML	$\overline{D13}$	Inverting Output high when disabled	-40°C to 125°C	2x2 MLF-8	Pb-Free
MIC44F19YMME		Inverting Output high when disabled	-40°C to 125°C	ePAD MSOP-8	Pb-Free
MIC44F20YML	$\overline{D14}$	Inverting Output low when disabled	-40°C to 125°C	2x2 MLF-8	Pb-Free
MIC44F20YMME		Inverting Output low when disabled	-40°C to 125°C	ePAD MSOP-8	Pb-Free

### Note:

- Over bar symbol may not be to scale.

## Pin Configuration

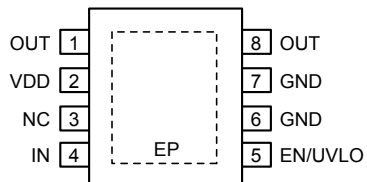

8-Pin ePAD MSOP (MME)

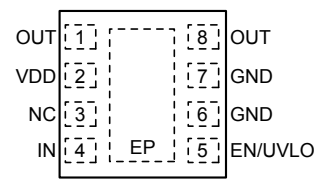

8-Pin MLF (ML)

## Pin Description

Pin Number	Pin Name	Pin Function
1,8	OUT	Driver Output
2	VDD	Supply Input
3	NC	No Connect
4	IN	Input (Input): Logic high produces a high output voltage for the MIC44F18 and a low output voltage for the MIC44F19/20. Logic low produces a low output voltage for the MIC44F18 and a high output voltage for the MIC44F19/20.
5	EN/UVLO	EN / Under-Voltage Lockout (Input): Pulling this pin below low disables the driver. When disabled, the output is in the off state (low for the MIC44F18/20 and high for the MIC44F19). Floating this pin enables the driver and the UVLO circuitry when $V_{DD}$ reaches the UVLO threshold. A resistor divider can set a different UVLO threshold voltage as shown on page 1 (See "Application Information" section for more details).
6,7	GND	Ground
EP	GND	Ground. Exposed Backside Pad.

**Logic Table**

<b>EN/UVLO</b>	<b>IN</b>	<b>MIC44F18 OUTPUT</b>	<b>MIC44F19 OUTPUT</b>	<b>MIC44F20 OUTPUT</b>
0	0	LOW	HI	LOW
0	1	LOW	HI	LOW
1	0	LOW	HI	HI
1	1	HI	LOW	LOW

**Absolute Maximum Ratings<sup>(1)</sup>**

Supply Voltage ( $V_{dd}$ )	14V
UVLO/Enable Voltage ( $V_{UVLO/EN}$ )	14V
Input Voltage ( $V_{IN}$ )	( $V_S + 0.1V$ ) to (GND-5V)
Output Voltage ( $V_{OUT}$ )	14V
Junction Temperature ( $T_J$ )	150°C
Ambient Storage Temperature ( $T_{dd}$ )	-65°C to +150°C
Lead Temperature (10 sec)	300°C
<b>ESD Rating, Note 3</b>	
Pins 1,2,3,5,6,7,8	2KV
Pin 4	500V

**Operating Ratings<sup>(2)</sup>**

Supply Voltage ( $V_{dd}$ )	4.5V to 13.2V
Package Thermal Impedance	
ePAD MSOP-8 ( $\theta_{JA}$ )	78°C/W
2x2 MLF-8L ( $\theta_{JA}$ )	93°C/W
Operating Junction Temperature ( $T_J$ )	125°C

**Electrical Characteristics<sup>(4)</sup>**

4.5V ≤  $V_{dd}$  ≤ 13.2V;  $C_L$  = 1000pf;  $T_A$  = 25°C, **bold** values indicate  $-40^\circ\text{C} \leq T_J \leq +125^\circ\text{C}$ , unless noted.

Symbol	Parameter	Condition	Min.	Typ.	Max.	Units
<b>Power Supply</b>						
$V_{dd}$	Supply Voltage Range		<b>4.5</b>		<b>13.2</b>	V
$I_S$	High Output Quiescent Current	$V_{IN} = 5V$ (MIC44F18), $V_{IN} = 0V$ (MIC44F19/20)			<b>2.5</b>	mA
	Low Output Quiescent Current	$V_{IN} = 0V$ (MIC44F18), $V_{IN} = 5V$ (MIC44F19/20)			<b>2.5</b>	mA
$I_{SD}$	Shutdown Current	$V_{EN} = 0V$			<b>200</b>	μA
<b>EN/UVLO</b>						
$V_{EN}$	Enable Threshold		<b>1.3</b>	<b>1.4</b>	<b>1.5</b>	V
	Enable Hysteresis			120		mV
$V_{UVLO}$	Under-Voltage Lockout Threshold (Internally Set)	$V_{EN} = \text{open}$ $V_{DD}$ rising	3.6	4.2	4.4	V
	UVLO Hysteresis			370		mV
$V_{UVLO}$	Under-Voltage Lockout Threshold (Externally Set)	$V_{DD}$ rising	$V_{EN}$ (MAX)		$V_{dd}$	V
<b>Input</b>						
$V_{IN}$	Input Voltage Range	Steady State Voltage (note 5)	<b>0</b>		<b>V<sub>dd</sub></b>	
$V_{IH}$	Logic 1 Input Voltage	$T_A = 25^\circ\text{C}$ (+/-5%)	1.615	1.7	1.785	V
		Over temperature range (+/-10%)	<b>1.53</b>	<b>1.7</b>	<b>1.87</b>	
$V_{IL}$	Logic 0 Input Voltage	$T_A = 25^\circ\text{C}$ (+/-5%)	1.45	1.53	1.607	V
		Over temperature range (+/-10%)	<b>1.377</b>	<b>1.53</b>	<b>1.683</b>	
$I_{IN}$	Input Current	4.5V ≤ $V_{IN}$ ≤ 10V			<b>5</b>	μA

## Electrical Characteristics (Continued)

4.5V ≤ V<sub>dd</sub> ≤ 13.2V; C<sub>L</sub> = 1000pF; T<sub>A</sub> = 25°C, **bold** values indicate -40°C ≤ T<sub>j</sub> ≤ +125°C, unless noted.

Symbol	Parameter	Condition	Min.	Typ.	Max.	Units
<b>Output</b>						
V <sub>OH</sub>	High Output Voltage	See Figure 1	<b>V<sub>S</sub>- 0.025</b>			V
V <sub>OL</sub>	Low Output Voltage	See Figure 1			<b>0.025</b>	V
R <sub>O</sub>	Output Resistance, Output High	I <sub>OUT</sub> = 100mA, V <sub>dd</sub> = 12V I <sub>OUT</sub> = 100mA, V <sub>dd</sub> = 5V			<b>2</b> <b>3</b>	Ω
	Output Resistance, Output Low	I <sub>OUT</sub> = 100mA, V <sub>dd</sub> = 12V I <sub>OUT</sub> = 100mA, V <sub>dd</sub> = 5V			<b>2</b> <b>3</b>	Ω
I <sub>PEAK</sub>	Peak Output Sink Current	V <sub>dd</sub> = 12V	<b>6</b>			A
	Peak Output Source Current	V <sub>S</sub> = 12V	<b>6</b>			A
I <sub>R</sub>	Latch-Up Protection Withstand Reverse Current		<b>&gt;500</b>			mA
<b>Switching Time</b>						
t <sub>R</sub>	Rise Time	V <sub>S</sub> = 12V, C <sub>L</sub> = 1000pF See Timing Diagram		10	<b>20</b>	ns
t <sub>F</sub>	Fall Time	V <sub>S</sub> = 12V, C <sub>L</sub> = 1000pF See Timing Diagram		10	<b>20</b>	ns
t <sub>D1</sub>	Delay Time	V <sub>S</sub> = 12V, C <sub>L</sub> = 1000pF See Timing Diagram		15	<b>35</b>	ns
t <sub>D2</sub>	Delay Time	V <sub>S</sub> = 12V, C <sub>L</sub> = 1000pF See Timing Diagram		13	<b>35</b>	ns
t <sub>PW</sub>	Pulse Width	V <sub>S</sub> = 12V See Timing Diagram	<b>50</b>			ns
f <sub>MAX</sub>	Maximum Input Frequency	V <sub>S</sub> = 12V See Timing Diagram 2		<b>Note 6</b>		MHz

### Notes:

1. Exceeding the absolute maximum rating may damage the device.
2. The device is not guaranteed to function outside its operating rating.
3. Devices are ESD sensitive. Handling precautions recommended. Human body model, 1.5k in series with 100pF.
4. Specification for packaged product only.
5. The device is protected from damage when -5V < V<sub>in</sub> < 0V. However, 0V is the recommended minimum continuous V<sub>IL</sub> voltage. See the applications section for additional information.
6. See applications section for information on the maximum operating frequency.

# Typical Characteristics

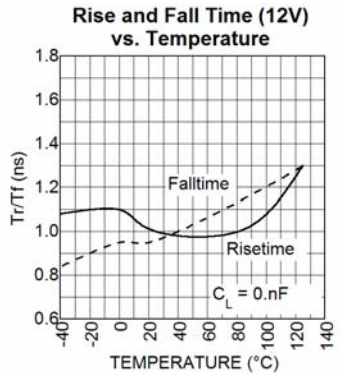
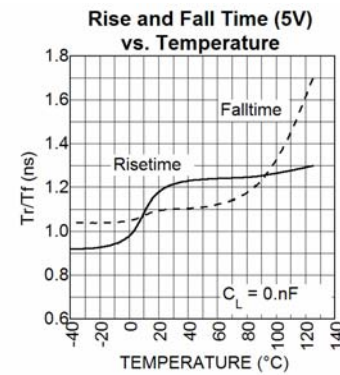
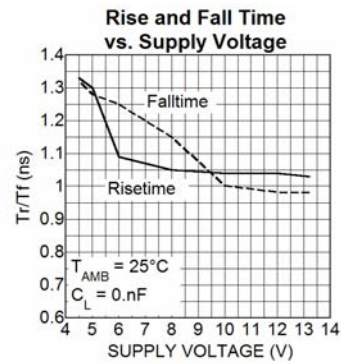
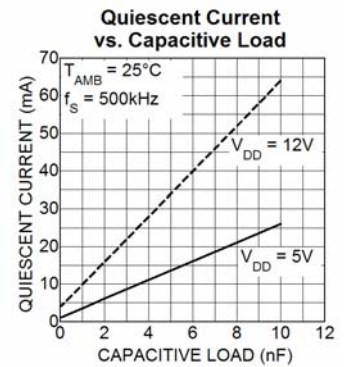
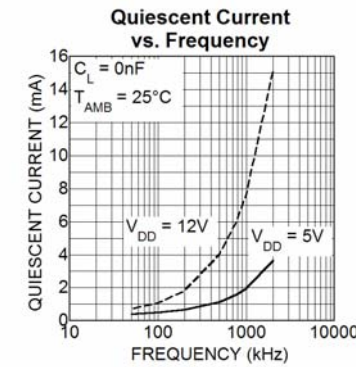
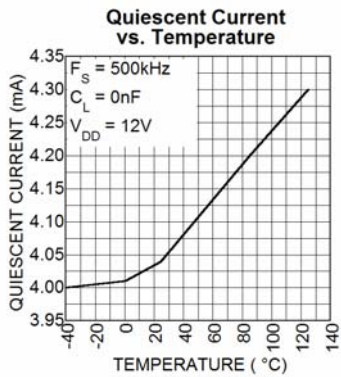
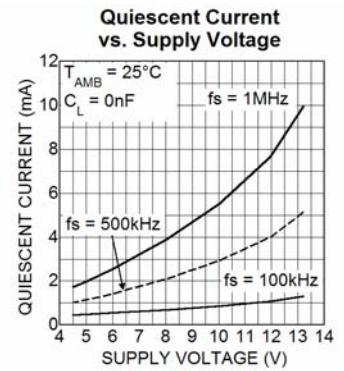
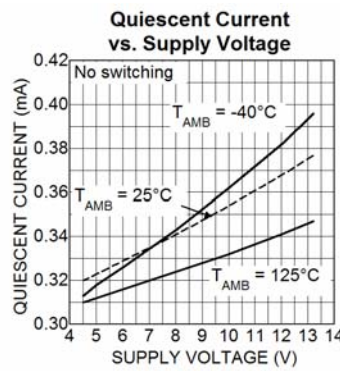
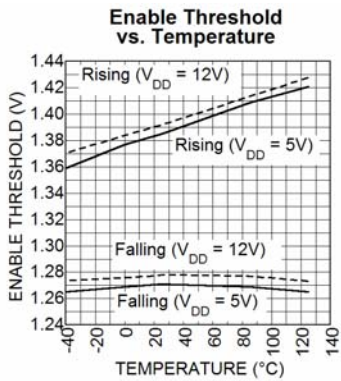
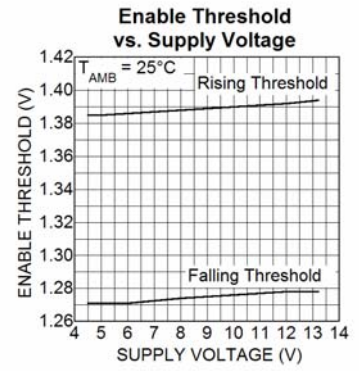
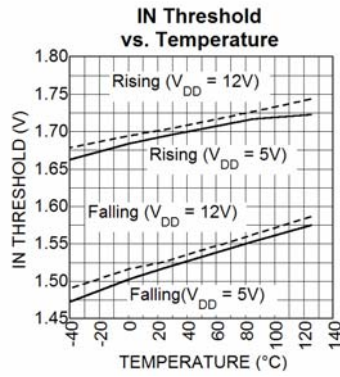
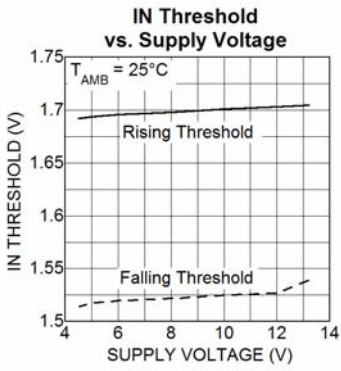

**Typical Characteristics cont.**

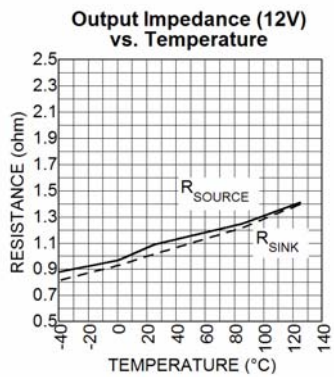
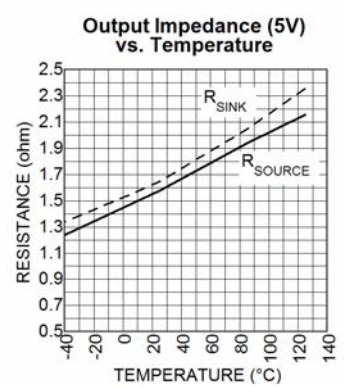
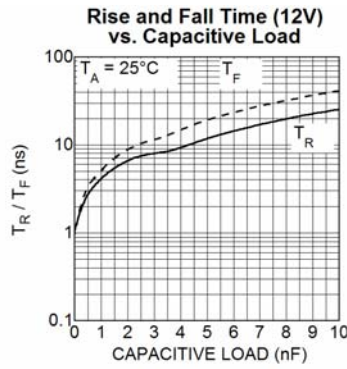
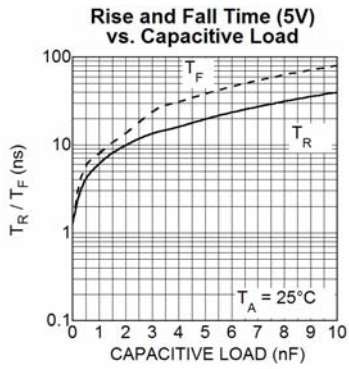
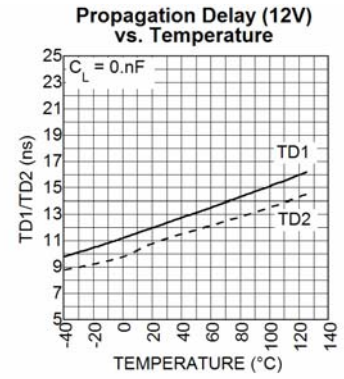
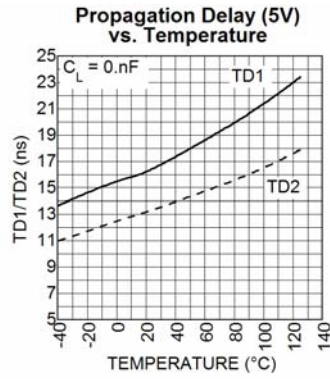
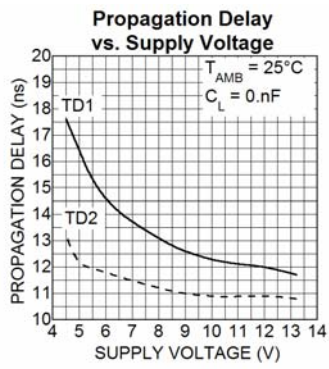





## Functional Description

The MIC44F18/19/20 family of drivers are high speed, high current drivers that are designed to drive P-channel and N-channel MOSFETs. The drivers come in both inverting and non-inverting versions. The block diagram of the MIC44Fxx driver is shown in Figure 1.

The MIC44F18 is a non-inverting driver. When disabled, the VOUT pin is pulled low. The MIC44F19 is an inverting driver that is optimized to drive P-channel MOSFETs. When disabled, the VOUT pin is pulled high, which turns off the P-channel MOSFET. The MIC44F20 is an inverting driver, whose VOUT pin is pulled low when disabled. This allows it to drive an N-channel MOSFETs and turn it off when the driver is disabled. The logic table below summarizes the driver operation.

EN/UVLO	IN	MIC44F18 OUTPUT	MIC44F19 OUTPUT	MIC44F20 OUTPUT
0	0	LOW	HI	LOW
0	1	LOW	HI	LOW
1	0	LOW	HI	HI
1	1	HI	LOW	LOW

### Startup and UVLO

The UVLO circuit disables the output until the V<sub>DD</sub> supply voltage exceeds the UVLO threshold. Hysteresis in the UVLO circuit prevents noise and finite circuit impedance from causing chatter during turn-on and turn-off.

As shown in figure 2, with the EN/UVLO pin open, an internal resistor divider senses the V<sub>DD</sub> voltage and the UVLO threshold is set at the minimum operating voltage of the driver. The driver can be set to turn on at a higher voltage by adding an external resistor to the UVLO pin.

With an external divider, the V<sub>DD</sub> turn on (rising V<sub>DD</sub>) threshold is calculated as:

$$V_{DDenable} = V_{TH} \times \left[ 1 + \frac{R1}{R2} \right]$$

$$V_{DDhysteresis} = V_{Hyst} \times \left[ 1 + \frac{R1}{R2} \right]$$

where: V<sub>TH</sub> = Enable Threshold Voltage

V<sub>DDhysteresis</sub> = Hysteresis Voltage at the VDD pin

V<sub>Hyst</sub> = Enable Hysteresis Voltage

Because the external resistors are parallel with the internal resistors, it is important to keep the value of the external resistors at least 10 times lower than the typical values of the internal resistors. This prevents the internal resistors from affecting the accuracy of the enable calculation as well as preventing the large tolerance of the internal resistors from affecting the tolerance of the enable voltage setting.

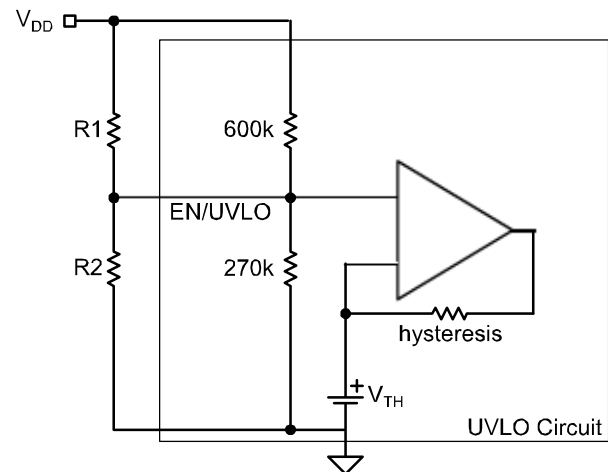

Figure 2. UVLO Circuit

### Input Stage

The MIC44Fxx family of drivers have a high impedance, TTL compatible input stage. The tight tolerance of the input threshold makes it compatible with CMOS devices powered from any supply voltage between 3V and V<sub>DD</sub>. Hysteresis on the input pin improves noise immunity and prevents input signals with slow rise times from falsely triggering the output. The amplitude of the input voltage has no effect on the supply current draw of the driver.

The input voltage signal may go up to -5V below ground without damaging the driver or causing a latch up condition. Negative input voltages 0.7V below ground or greater will cause an increase in propagation delay.

### Output Driver Section

A block diagram of the low-side driver is shown in Figure 3. Low driver impedances allow the external MOSFET to be turned on and off quickly. The rail-to-rail drive capability of the output ensures a low  $R_{\text{DS(on)}}$  from the external MOSFET.

Redundant Vout pins lower the driver circuit impedance, which helps increase the drive current and minimize LC circuit ringing between the MOSFET gate and driver output.

The slew rate of the output is non-adjustable and depends only on the  $V_{\text{DD}}$  voltage and how much capacitance is present at the VOUT pin. The slew rate at the MOSFET gate can be adjusted by adding a resistor between the MOSFET gate and the driver output.

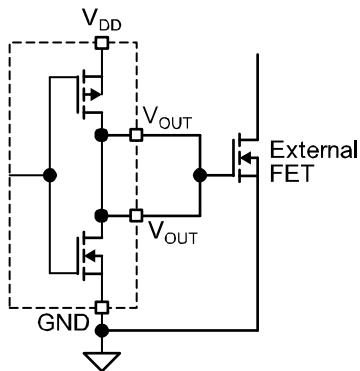

Figure 3. Output Driver Section

## Application Information

### Power Dissipation Considerations

Power dissipation in the driver can be separated into two areas:

- Output driver stage dissipation
- Quiescent current dissipation used to supply the internal logic and control functions.

### Output Driver Stage Power Dissipation

Power dissipation in the output driver stage is mainly caused by charging and discharging the gate to source and gate to drain capacitance of the external MOSFET. Figure 4 shows a simplified equivalent circuit of the MIC44F18 driving an external MOSFET.

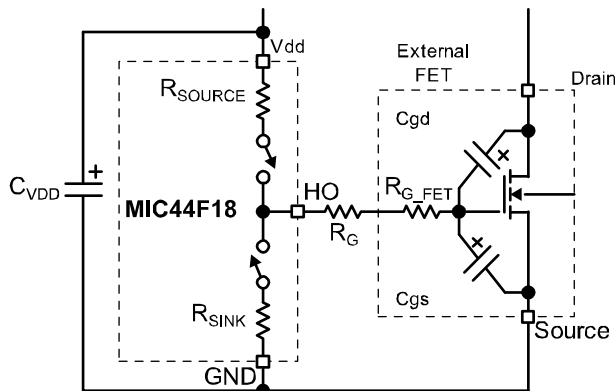

Figure 4. Output Driver Stage Power Dissipation

### Dissipation during the External MOSFET Turn-On

Energy from capacitor  $C_{VDD}$  is used to charge up the input capacitance of the MOSFET ( $C_{GD}$  and  $C_{GS}$ ). The energy delivered to the MOSFET is dissipated in the three resistive components,  $R_{ON}$ ,  $R_G$  and  $R_{G\_FET}$ .  $R_{ON}$  is the on resistance of the upper driver MOSFET in the MIC44F18.  $R_G$  is the series resistor (if any) between the driver IC and the MOSFET.  $R_{G\_FET}$  is the gate resistance of the MOSFET.  $R_{G\_FET}$  is usually listed in the power MOSFET's specifications. The ESR of capacitor  $C_B$  and the resistance of the connecting etch can be ignored since they are much less than  $R_{ON}$  and  $R_{G\_FET}$ .

The effective capacitance of  $C_{GD}$  and  $C_{GS}$  is difficult to calculate since they vary non-linearly with  $I_D$ ,  $V_{GS}$ , and  $V_{DS}$ . Fortunately, most power MOSFET specifications include a typical graph of total gate charge vs.  $V_{GS}$ . Figure 5 shows a typical gate charge curve for an arbitrary power MOSFET. This illustrates that for a gate voltage of 10V, the MOSFET requires about 23.5nC of charge.

The energy dissipated by the resistive components of the gate drive circuit during turn-on is calculated as:

$$E = \frac{1}{2} \times C_{iss} \times V_{GS}^2$$

but

$$Q = C \times V$$

so

$$E = 1/2 \times Q_G \times V_{GS}$$

where

$C_{iss}$  is the total gate capacitance of the MOSFET

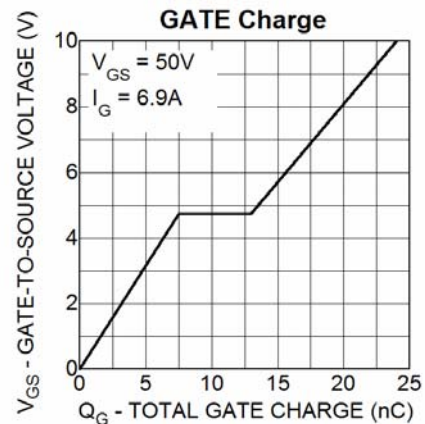

Figure 5. GATE Charge

The same energy is dissipated by  $R_{OFF}$ ,  $R_G$  and  $R_{G\_FET}$  when the driver IC turns the MOSFET off. Assuming  $R_{on}$  is approximately equal to  $R_{OFF}$ , the total energy and power dissipated by the resistive drive elements is:

$$E_{DRIVER} = Q_G \times V_{GS}$$

and

$$P_{DRIVER} = Q_G \times V_{GS} \times f_S$$

Where

$E_{DRIVER}$  is the energy dissipated per switching power

$P_{DRIVER}$  is the power dissipated by switching the MOSFET on and off

$Q_G$  is the total GATE charge at  $V_{GS}$

$V_{GS}$  is the GATE to SOURCE voltage on the MOSFET

$f_S$  is the switching frequency of the GATE drive circuit

The power dissipated inside the MIC4100/4101 is equal to the ratio of  $R_{ON}$  &  $R_{OFF}$  to the external resistive losses in  $R_G$  and  $R_{G\_FET}$ . Letting  $R_{ON} = R_{OFF}$ , the power dissipated in the MIC44F18 due to driving the external MOSFET is:

$$P_{diss\_drive} = P_{DRIVER} \frac{R_{ON}}{R_{ON} + R_G + R_{G\_FET}}$$

**Supply Current Power Dissipation**

Power is dissipated in the MIC44F18 even if is there is nothing being driven. The supply current is drawn by the bias for the internal circuitry, the level shifting circuitry and shoot-through current in the output drivers. The supply current is proportional to operating frequency and the  $V_{DD}$  voltage. The typical characteristic graphs show how supply current varies with switching frequency and supply voltage.

The power dissipated by the MIC44F18 due to supply current is:

$$P_{diss\_SUPPLY} = V_{DD} \times I_{DD}$$

**Total Power Dissipation and Thermal Considerations**

Total power dissipation in the Driver equals the power dissipation caused by driving the external MOSFETs plus the supply current:

$$P_{diss\_TOTAL} = P_{diss\_SUPPLY} + P_{diss\_DRIVE}$$

The die temperature may be calculated once the total power dissipation is known:

$$T_J = T_A + P_{diss\_TOTAL} \times \theta_{JA}$$

Where

$T_A$  is the Maximum ambient temperature

$T_J$  is the junction temperature (°C)

$P_{diss\_TOTAL}$  is the power dissipation of the Driver

$\theta_{JC}$  is the thermal resistance from junction-to-ambient air (°C/W)

The following graphs help determine the maximum gate charge that can be driven with respect to switching frequency, supply voltage and ambient temperature.

Figure 6A shows the power dissipation in the driver for different values of gate charge with  $V_{DD}=5V$ . Figure 6B shows the power dissipation at  $V_{DD}=12V$ . Figure 6C show the maximum power dissipation for a given ambient temperature for the MLF and ePad packages.

The maximum operating frequency of the driver may be limited by the maximum power dissipation of the driver package.

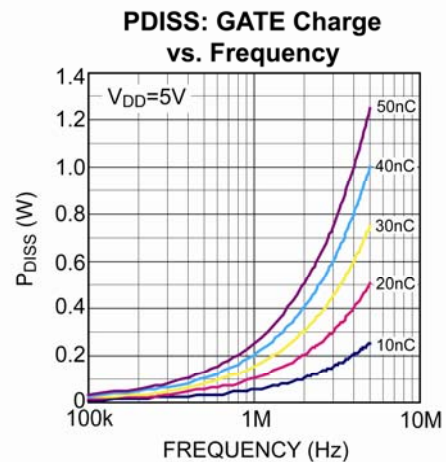

Figure 6A. Driver Power Dissipation

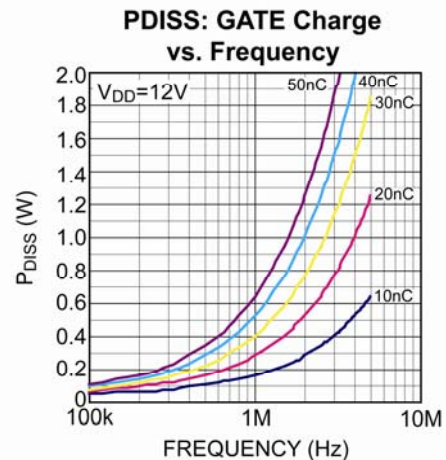

Figure 6B. Driver Power Dissipation

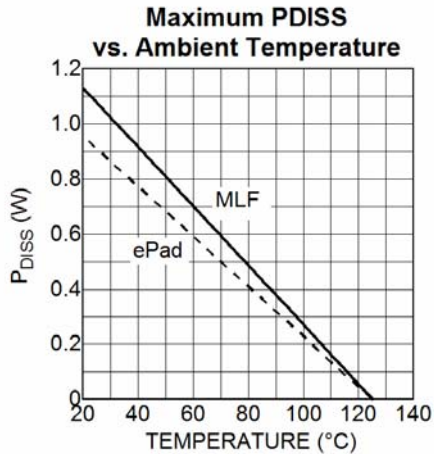

Figure 6C. Maximum Driver Power Dissipation

**Propagation Delay and Delay Matching and Other Timing Considerations**

Fast propagation delay between the input and output drive waveform is desirable. It improves overcurrent protection by decreasing the response time between the control signal and the MOSFET gate drive. Minimizing propagation delay also minimizes phase shift errors in power supplies with wide bandwidth control loops.

Care must be taken to insure the input signal pulse width is greater than the minimum specified pulse width. An input signal that is less than the minimum pulse width may result in no output pulse or an output pulse whose width is significantly less than the input.

**Decoupling and Bootstrap Capacitor Selection**

Decoupling capacitors are required for proper operation by supplying the charge necessary to drive the external MOSFETs as well as minimizing the voltage ripple on the supply pins.

Ceramic capacitors are recommended because of their low impedance and small size. Z5U type ceramic capacitor dielectrics are not recommended due to the large change in capacitance over temperature and voltage. A minimum value of 0.1µf is required for each of the capacitors, regardless of the MOSFETs being driven. Larger MOSFETs may require larger capacitance values for proper operation. The voltage rating of the capacitors depends upon the supply voltage, ambient temperature and the voltage derating used for reliability.

Placement of the decoupling capacitors is critical. The bypass capacitor for VDD should be placed as close as possible between the VDD and VSS pins. The etch connections must be short, wide and direct. The use of a ground plane to minimize connection impedance is recommended. Refer to the section on layout and component placement for more information.

**Grounding, Component Placement and Circuit Layout**

Nanosecond switching speeds and ampere peak currents in and around the MOSFET driver requires proper placement and trace routing of all components. Improper placement may cause degraded noise immunity, false switching and excessive ringing.

Figure 7 shows the critical current paths when the driver outputs go high and turn on the external MOSFETs. It also helps demonstrate the need for a low impedance ground plane. Charge needed to turn-on the MOSFET gates comes from the decoupling capacitors C<sub>VDD</sub>. Current in the gate driver flows from C<sub>VDD</sub> through the internal driver, into the MOSFET gate and out the source. The return connection back to the decoupling capacitor is made through the ground plane. Any inductance or resistance in the ground return path causes a voltage spike or ringing to appear on the source of the MOSFET. This voltage works against the gate drive voltage and can either slow down or turn off the MOSFET during the period when it should be turned on.

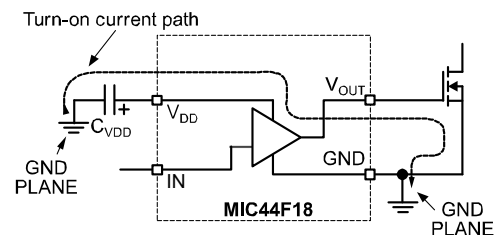
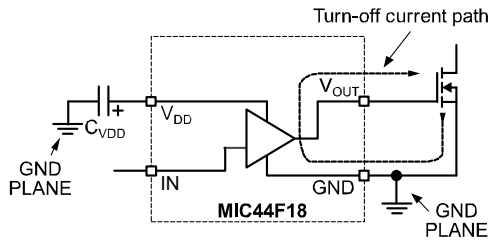

Figure 7. Critical Current Paths for High Driver Outputs

Figure 8 shows the critical current paths when the driver outputs go low and turn off the external MOSFETs. Short, low impedance connections are important during turn-off for the same reasons given in the turn-on explanation. Current from the  $V_{DD}$  supply replenishes charge in the decoupling capacitor,  $C_{VDD}$ .

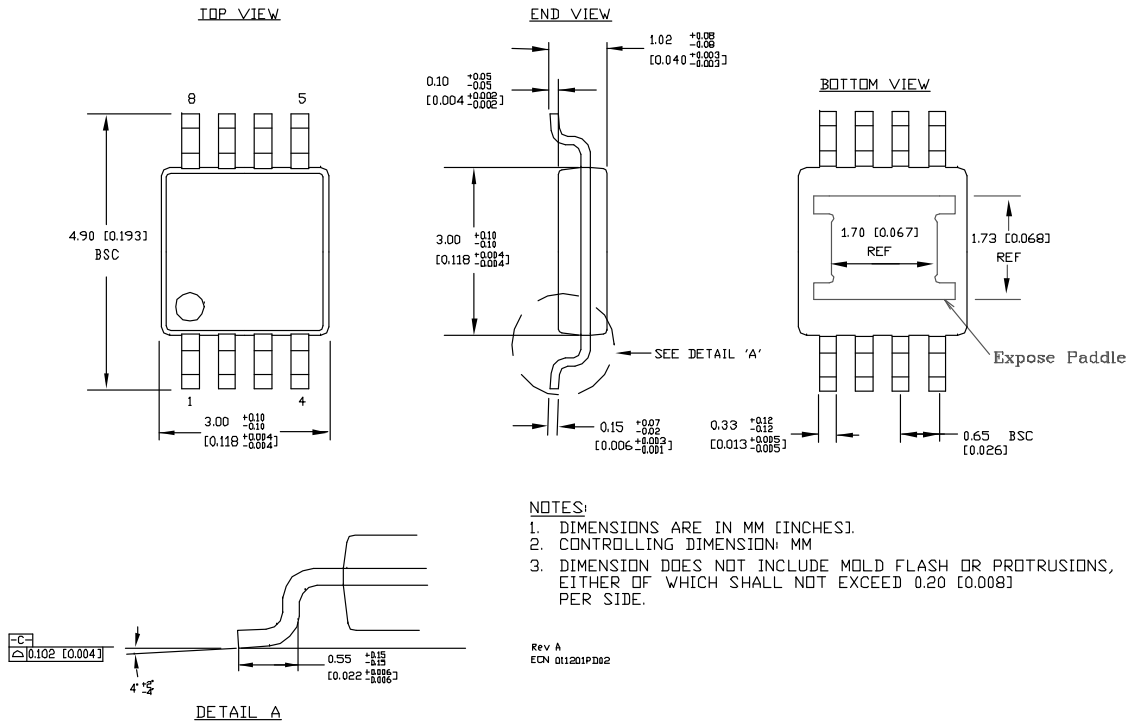

**Figure 8. Critical Current Paths for High Driver Outputs**

The following circuit guidelines should be adhered to for optimum circuit performance:

1. The  $V_{CC}$  bypass capacitor must be placed close to the VDD and ground pins. It is critical that the etch length between the decoupling capacitor and the VDD & GND pins be minimized to reduce pin inductance.
2. A ground plane is recommended to minimize parasitic inductance and impedance of the return paths. The MIC44F18 family of drivers is capable of high peak currents and very fast transition times. Any impedance between the driver, the decoupling capacitors and the external MOSFET will degrade the performance of the circuit.
3. Trace out the high di/dt and dv/dt paths, as shown in Figures 7 and 8 and minimize etch length and loop area for these connections. Minimizing these parameters decreases the parasitic inductance and the radiated EMI generated by fast rise and fall times.

# Package Information



## 8-Pin ePad MSOP (MME)

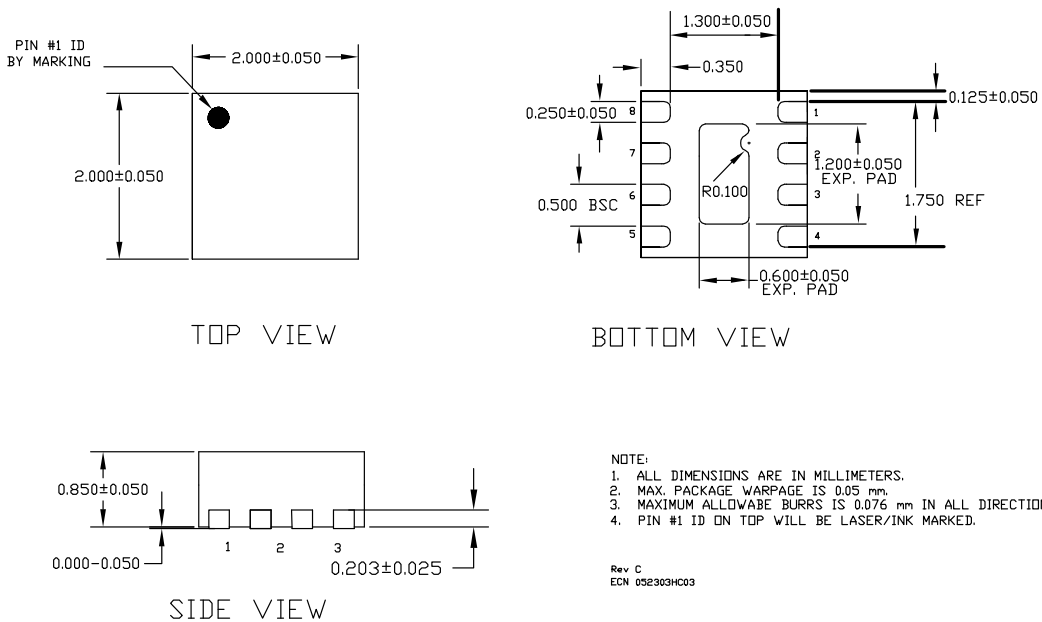

## 8-Pin 2mm x 2mm MLF (ML)



---

**MICREL, INC. 2180 FORTUNE DRIVE SAN JOSE, CA 95131 USA**  
TEL +1 (408) 944-0800 FAX +1 (408) 474-1000 WEB <http://www.micrel.com>

Micrel makes no representations or warranties with respect to the accuracy or completeness of the information furnished in this data sheet. This information is not intended as a warranty and Micrel does not assume responsibility for its use. Micrel reserves the right to change circuitry, specifications and descriptions at any time without notice. No license, whether express, implied, arising by estoppel or otherwise, to any intellectual property rights is granted by this document. Except as provided in Micrel's terms and conditions of sale for such products, Micrel assumes no liability whatsoever, and Micrel disclaims any express or implied warranty relating to the sale and/or use of Micrel products including liability or warranties relating to fitness for a particular purpose, merchantability, or infringement of any patent, copyright or other intellectual property right

Micrel Products are not designed or authorized for use as components in life support appliances, devices or systems where malfunction of a product can reasonably be expected to result in personal injury. Life support devices or systems are devices or systems that (a) are intended for surgical implant into the body or (b) support or sustain life, and whose failure to perform can be reasonably expected to result in a significant injury to the user. A Purchaser's use or sale of Micrel Products for use in life support appliances, devices or systems is a Purchaser's own risk and Purchaser agrees to fully indemnify Micrel for any damages resulting from such use or sale.

© 2005 Micrel, Incorporated.

# Mouser Electronics

Authorized Distributor

Click to View Pricing, Inventory, Delivery & Lifecycle Information:

[Micrel:](#)

[MIC44F18YMME](#) [MIC44F19YMME](#) [MIC44F18YML TR](#) [MIC44F20YML TR](#) [MIC44F20YMME](#) [MIC44F18YML-TR](#)  
[MIC44F19YML-TR](#) [MIC44F20YML-TR](#) [MIC44F18YMME-TR](#) [MIC44F20YMME-TR](#) [MIC44F19YMME-TR](#)



Компания «ЭлектроПласт» предлагает заключение долгосрочных отношений при поставках импортных электронных компонентов на взаимовыгодных условиях!

Наши преимущества:

- Оперативные поставки широкого спектра электронных компонентов отечественного и импортного производства напрямую от производителей и с крупнейших мировых складов;
- Поставка более 17-ти миллионов наименований электронных компонентов;
- Поставка сложных, дефицитных, либо снятых с производства позиций;
- Оперативные сроки поставки под заказ (от 5 рабочих дней);
- Экспресс доставка в любую точку России;
- Техническая поддержка проекта, помощь в подборе аналогов, поставка прототипов;
- Система менеджмента качества сертифицирована по Международному стандарту ISO 9001;
- Лицензия ФСБ на осуществление работ с использованием сведений, составляющих государственную тайну;
- Поставка специализированных компонентов (Xilinx, Altera, Analog Devices, Intersil, Interpoint, Microsemi, Aeroflex, Peregrine, Syfer, Eurofarad, Texas Instrument, Miteq, Cobham, E2V, MA-COM, Hittite, Mini-Circuits, General Dynamics и др.);

Помимо этого, одним из направлений компании «ЭлектроПласт» является направление «Источники питания». Мы предлагаем Вам помощь Конструкторского отдела:

- Подбор оптимального решения, техническое обоснование при выборе компонента;
- Подбор аналогов;
- Консультации по применению компонента;
- Поставка образцов и прототипов;
- Техническая поддержка проекта;
- Защита от снятия компонента с производства.



#### Как с нами связаться

**Телефон:** 8 (812) 309 58 32 (многоканальный)

**Факс:** 8 (812) 320-02-42

**Электронная почта:** [org@eplast1.ru](mailto:org@eplast1.ru)

**Адрес:** 198099, г. Санкт-Петербург, ул. Калинина, дом 2, корпус 4, литера А.