

Cree® XLamp® XM-L2 LEDs

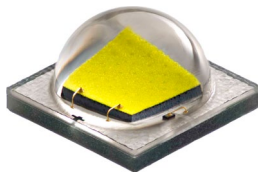

PRODUCT DESCRIPTION

The XLamp® XM-L2 LED builds on the unprecedented performance of the original XM-L, increasing lumen output up to 20% while providing a single die LED point source for precise optical control. The XM-L2 LED shares the same mechanical and optical footprint as the original XM-L, providing a seamless upgrade path and shortened design cycle.

XLamp XM-L2 LEDs are the ideal choice for lighting applications where high light output and maximum efficacy are required, such as LED light bulbs, outdoor lighting, portable lighting, indoor lighting and solar-powered lighting.

FEATURES

- Available in white, 70-CRI white, 80-CRI white, 85-CRI white and 90-CRI white
- ANSI-compatible chromaticity bins
- Binned at 85 °C
- Maximum drive current: 3000 mA
- Low thermal resistance: 2.5 °C/W
- Wide viewing angle: 125°
- Unlimited floor life at $\leq 30\text{ °C}/85\%\text{ RH}$
- Reflow solderable - JEDEC J-STD-020C
- Electrically neutral thermal path
- RoHS- and REACH-compliant
- UL® recognized component (E349212)

TABLE OF CONTENTS

Characteristics	2
Flux Characteristics	3
Relative Spectral Power Distribution	4
Relative Flux vs. Junction Temperature	4
Electrical Characteristics	5
Relative Flux vs. Current	5
Relative Chromaticity vs. Current	6
Relative Chromaticity vs. Temperature	6
Typical Spatial Distribution	7
Thermal Design	7
Reflow Soldering Characteristics	8
Notes	9
Mechanical Dimensions	11
Tape and Reel	12
Packaging	13



CHARACTERISTICS

Characteristics	Unit	Minimum	Typical	Maximum
Thermal resistance, junction to solder point	°C/W		2.5	
Viewing angle (FWHM)	degrees		125	
Temperature coefficient of voltage	mV/°C		-1.6	
ESD withstand voltage (HBM per Mil-Std-883D)	V			8000
DC forward current	mA			3000
Reverse voltage	V			-5
Forward voltage (@ 700 mA, 85 °C)	V		2.85	3.15
Forward voltage (@ 1500 mA, 85 °C)	V		3.05	
Forward voltage (@ 3000 mA, 85 °C)	V		3.3	
LED junction temperature	°C			150

FLUX CHARACTERISTICS (T_J = 85 °C)

The following table provides several base order codes for XLamp XM-L2 LEDs. It is important to note that the base order codes listed here are a subset of the total available order codes for the product family. For more order codes, as well as a complete description of the order-code nomenclature, please consult the XLamp XM LED Family Binning and Labeling document.

Color	CCT Range		Minimum Luminous Flux (lm) @ 700 mA			Calculated Minimum Luminous Flux (lm) @ 85 °C**			Order Code
	Min.	Max.	Group	Flux (lm) @ 85 °C	Flux (lm) @ 25 °C*	1000 mA	1500 mA	2000 mA	
Cool White	5000 K	8300 K	T5	260	296	357	502	631	XMLBWT-00-0000-0000T5051
			T6	280	318	385	541	679	XMLBWT-00-0000-0000T6051
			U2	300	342	412	580	728	XMLBWT-00-0000-0000U2051
			U3	320	364	439	618	776	XMLBWT-00-0000-0000U3051
Neutral White	3700 K	5000 K	T4	240	273	330	464	582	XMLBWT-00-0000-0000T40E4
			T5	260	296	357	502	631	XMLBWT-00-0000-0000T50E4
			T6	280	318	385	541	679	XMLBWT-00-0000-0000T60E4
Warm White	2600 K	3700 K	T2	200	227	275	386	485	XMLBWT-00-0000-0000T20E7
			T3	220	250	302	425	534	XMLBWT-00-0000-0000T30E7
			T4	240	273	330	464	582	XMLBWT-00-0000-0000T40E7
70-CRI White	3700 K	5000 K	T5	260	296	357	502	631	XMLBWT-00-0000-0000T50E3
			T6	280	318	385	541	679	XMLBWT-00-0000-0000T60E3
			U2	300	342	412	580	728	XMLBWT-00-0000-0000U20E3
80-CRI White	2600 K	4300 K	T2	200	227	275	386	485	XMLBWT-00-0000-0000T20E7
			T3	220	250	302	425	534	XMLBWT-00-0000-0000T30E7
			T4	240	273	330	464	582	XMLBWT-00-0000-0000T40E7
			T5	260	296	357	502	631	XMLBWT-00-0000-0000T50E7
85-CRI White	2600 K	3200 K	S4	164	186	225	317	398	XMLBWT-00-0000-0000S40E7
			S5	172	196	236	332	417	XMLBWT-00-0000-0000S50E7
			S6	182	207	250	352	442	XMLBWT-00-0000-0000S60E7
			T2	200	227	275	386	485	XMLBWT-00-0000-0000T20E7
90-CRI White	2600 K	3200 K	S4	164	186	225	317	398	XMLBWT-00-0000-0000S40E7
			S5	172	196	236	332	417	XMLBWT-00-0000-0000S50E7
			S6	182	207	250	352	442	XMLBWT-00-0000-0000S60E7
			T2	200	227	275	386	485	XMLBWT-00-0000-0000T20E7

Notes:

- Cree maintains a tolerance of ±7% on flux and power measurements, ±0.005 on chromaticity (CCx, CCy) measurements and ±2 on CRI measurements. See the Measurements section (page 9).
- Typical CRI for Cool White (5000 K – 8300 K CCT) is 65.
- Typical CRI for Neutral White (3700 K – 5000 K CCT) is 75.
- Typical CRI for Warm White (2600 K – 3700 K CCT) is 80.
- Minimum CRI for 70-CRI White is 70.
- Minimum CRI for 80-CRI White is 80.
- Minimum CRI for 85-CRI White is 85.
- Minimum CRI for 90-CRI White is 90.

* Flux values @ 25 °C are calculated and are for reference only.

** Calculated flux values at 1000 mA, 1500 mA and 2000 mA are for reference only.

RELATIVE SPECTRAL POWER DISTRIBUTION

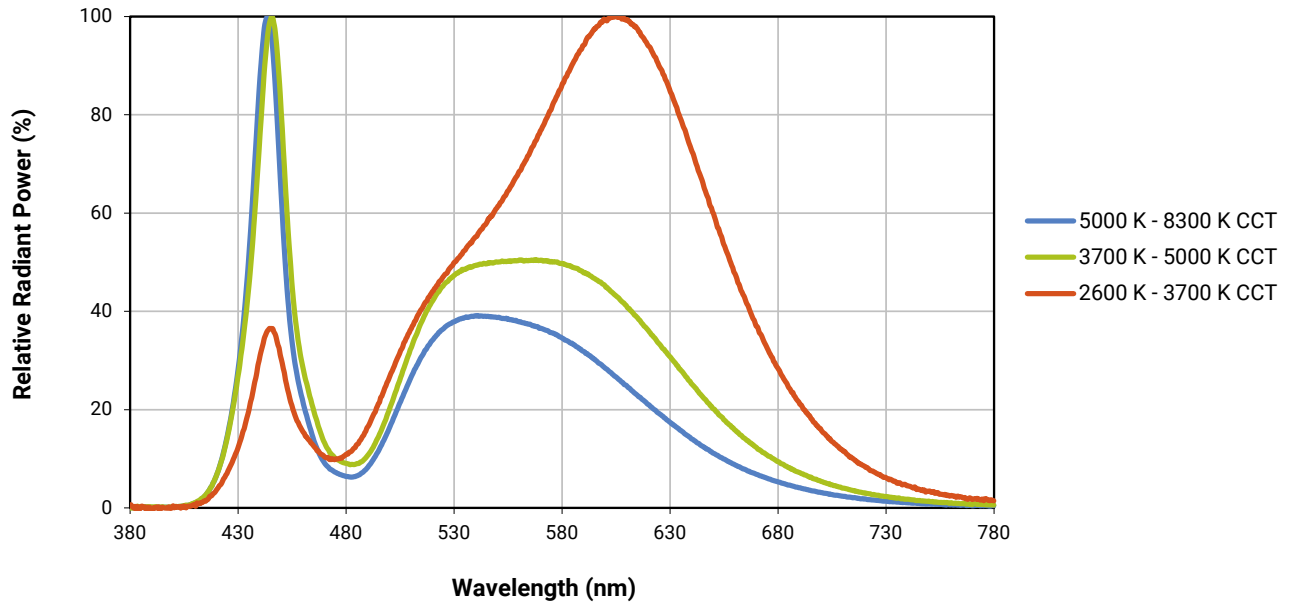

RELATIVE FLUX VS. JUNCTION TEMPERATURE ($I_F = 700$ mA)

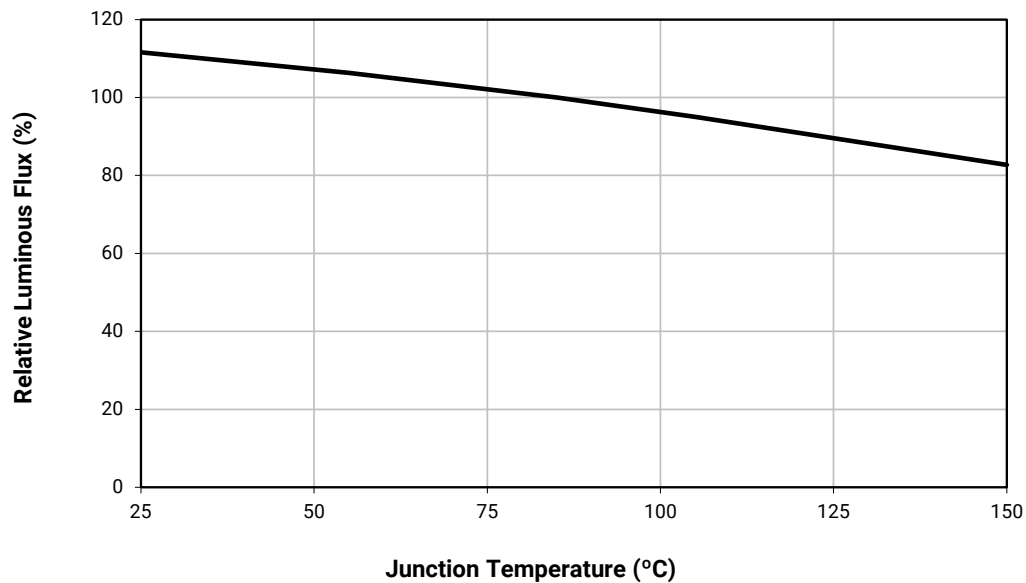

ELECTRICAL CHARACTERISTICS ($T_j = 85\text{ }^\circ\text{C}$)

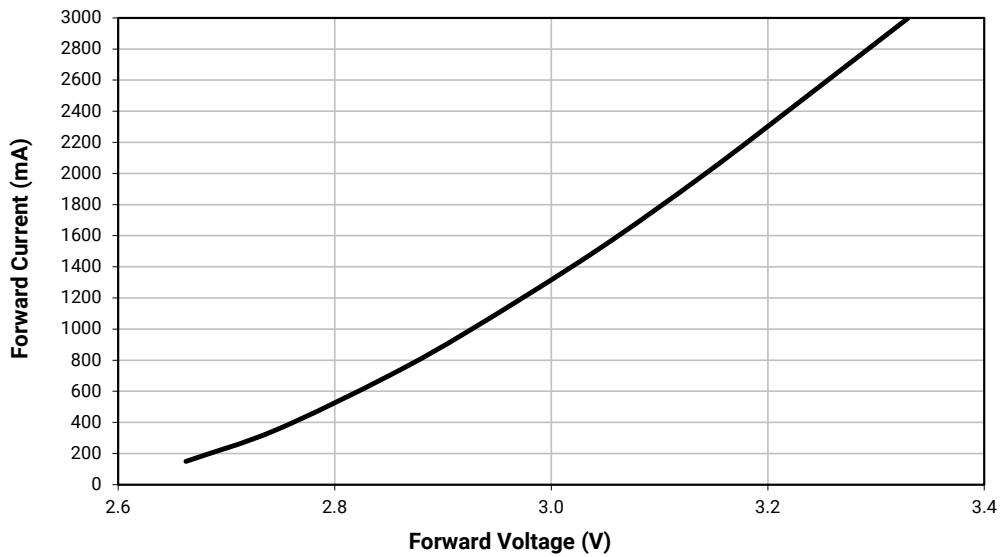

RELATIVE FLUX VS. CURRENT ($T_j = 85\text{ }^\circ\text{C}$)

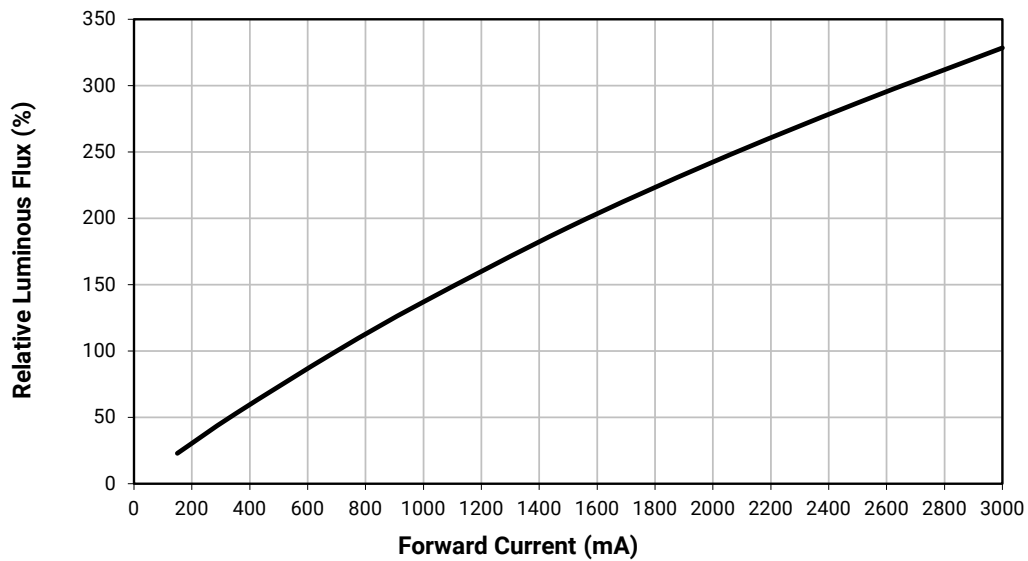

RELATIVE CHROMATICITY VS. CURRENT (WARM WHITE)

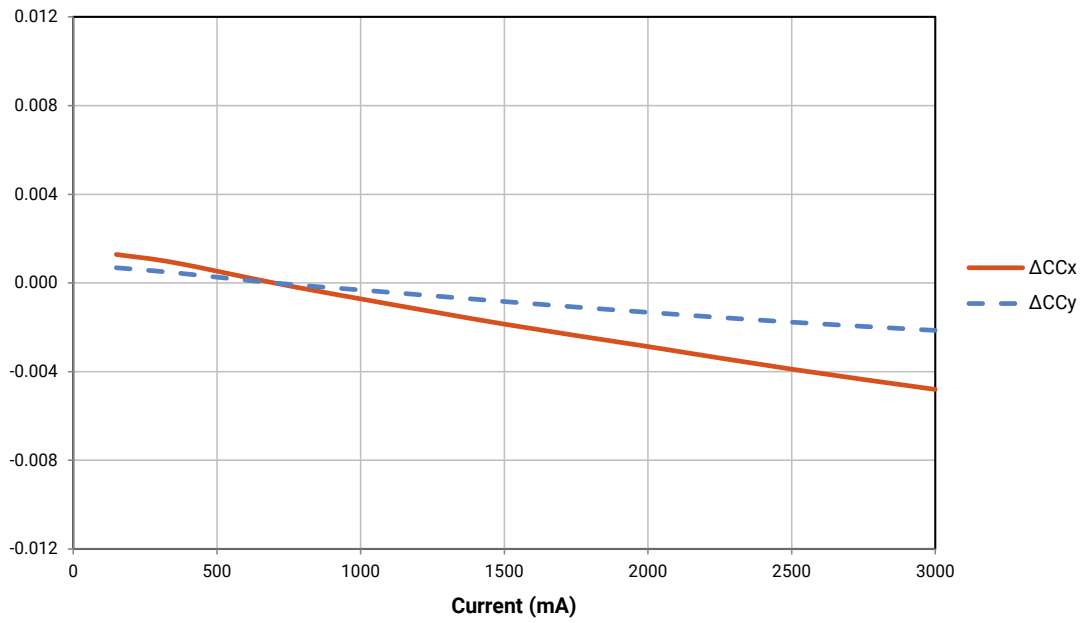

RELATIVE CHROMATICITY VS. TEMPERATURE (WARM WHITE)

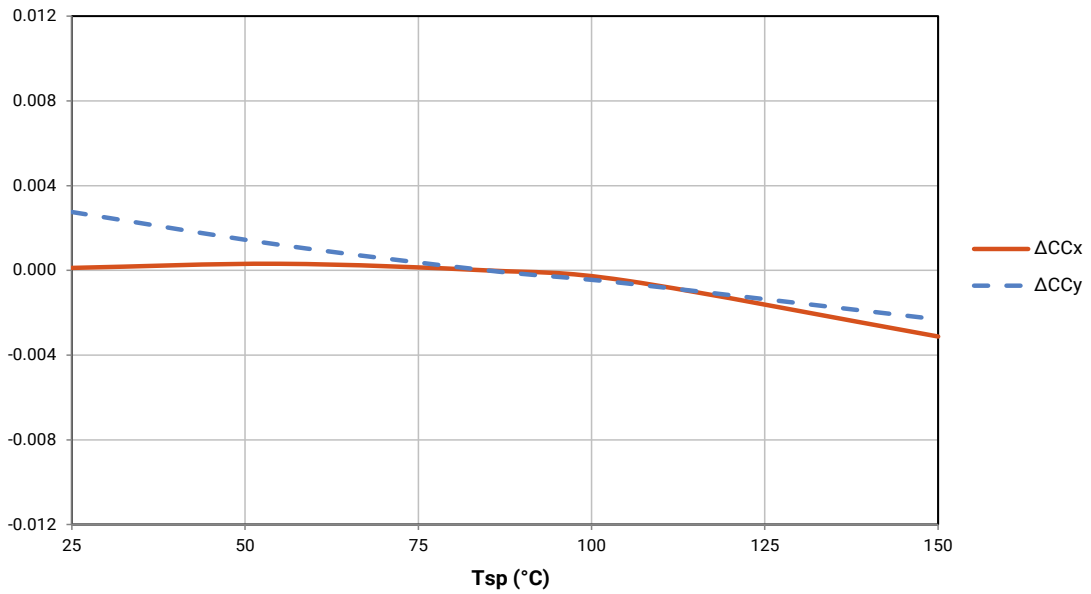

TYPICAL SPATIAL DISTRIBUTION

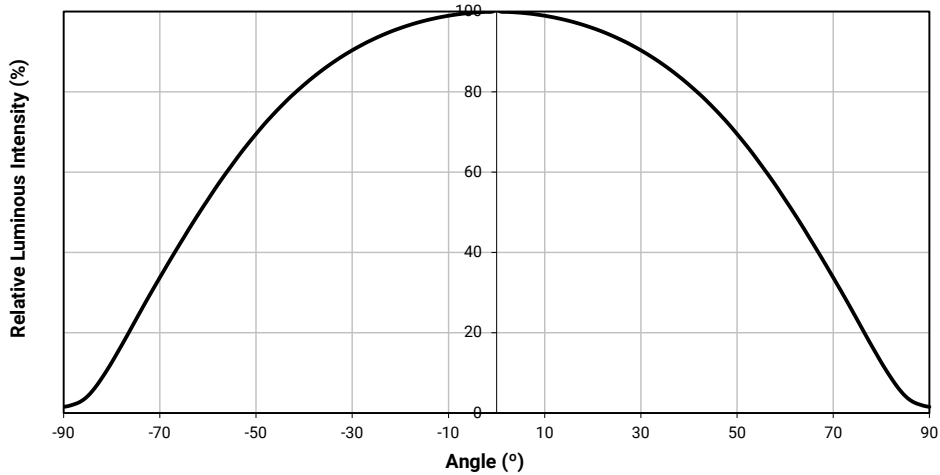

THERMAL DESIGN

The maximum forward current is determined by the thermal resistance between the LED junction and ambient. It is crucial for the end product to be designed in a manner that minimizes the thermal resistance from the solder point to ambient in order to optimize lamp life and optical characteristics.

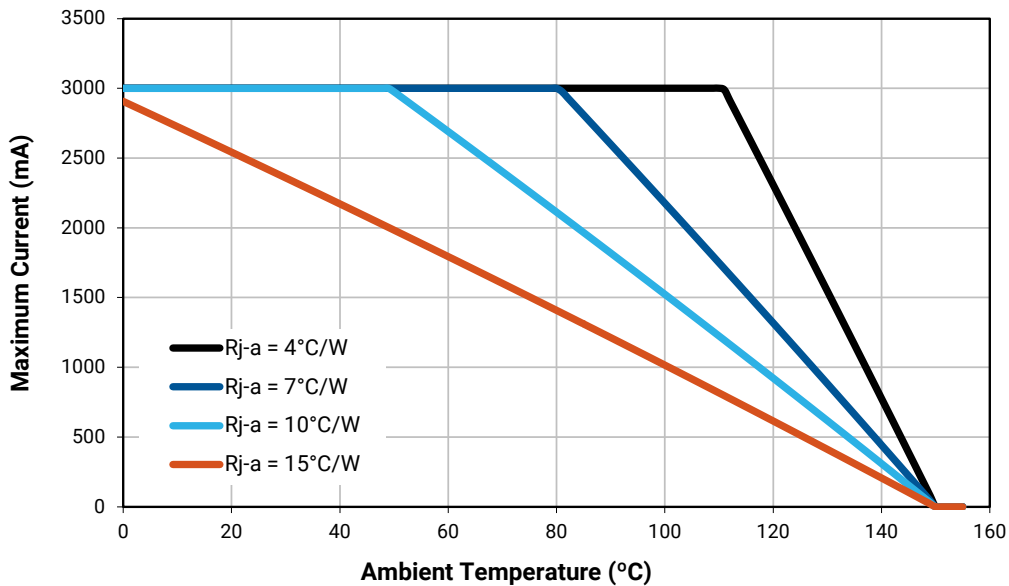

REFLOW SOLDERING CHARACTERISTICS

In testing, Cree has found XLamp XM-L2 LEDs to be compatible with JEDEC J-STD-020C, using the parameters listed below. As a general guideline, Cree recommends that users follow the recommended soldering profile provided by the manufacturer of the solder paste used.

Note that this general guideline may not apply to all PCB designs and configurations of reflow soldering equipment.

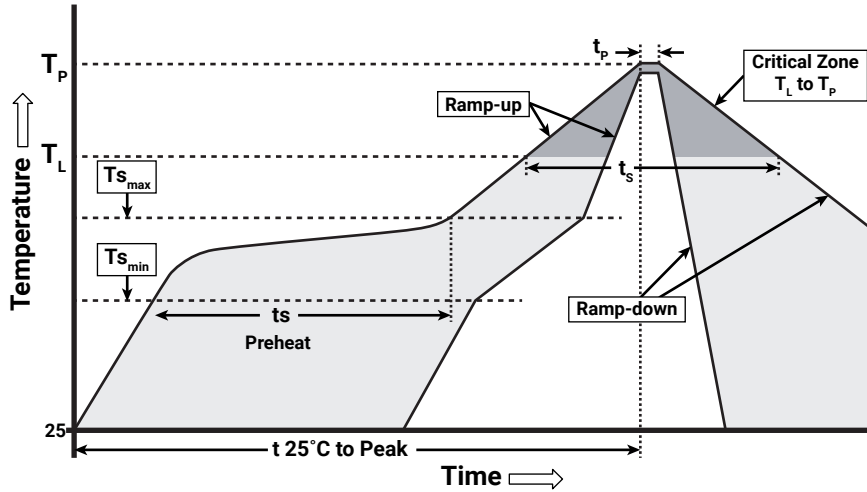

IPC/JEDEC J-STD-020C

Profile Feature	Lead-Free Solder
Average Ramp-Up Rate ($T_{S_{max}}$ to T_P)	1.2 °C/second
Preheat: Temperature Min ($T_{S_{min}}$)	120 °C
Preheat: Temperature Max ($T_{S_{max}}$)	170 °C
Preheat: Time ($t_{s_{min}}$ to $t_{s_{max}}$)	65-150 seconds
Time Maintained Above: Temperature (T_L)	217 °C
Time Maintained Above: Time (t_l)	45-90 seconds
Peak/Classification Temperature (T_P)	235 - 245 °C
Time Within 5 °C of Actual Peak Temperature (t_p)	20-40 seconds
Ramp-Down Rate	1 - 6 °C/second
Time 25 °C to Peak Temperature	4 minutes max.

Note: All temperatures refer to the topside of the package, measured on the package body surface.

NOTES

Measurements

The luminous flux, radiant power, chromaticity and CRI measurements in this document are binning specifications only and solely represent product measurements as of the date of shipment. These measurements will change over time based on a number of factors that are not within Cree's control and are not intended or provided as operational specifications for the products. Calculated values are provided for informational purposes only and are not intended as specifications.

Lumen Maintenance

Cree now uses standardized IES LM-80-08 and TM-21-11 methods for collecting long-term data and extrapolating LED lumen maintenance. For information on the specific LM-80 data sets available for this LED, refer to the public [LM-80 results document](#).

Please read the [Long-Term Lumen Maintenance application note](#) for more details on Cree's lumen maintenance testing and forecasting. Please read the [Thermal Management application note](#) for details on how thermal design, ambient temperature, and drive current affect the LED junction temperature.

Moisture Sensitivity

Cree recommends keeping XLamp LEDs in the provided, resealable moisture-barrier packaging (MBP) until immediately prior to soldering. Unopened MBPs that contain XLamp LEDs do not need special storage for moisture sensitivity.

Once the MBP is opened, XLamp XM-L2 LEDs may be stored as MSL 1 per JEDEC J-STD-033, meaning they have unlimited floor life in conditions of ≤ 30 °C/85% relative humidity (RH). Regardless of the storage condition, Cree recommends sealing any unsoldered LEDs in the original MBP.

RoHS Compliance

The levels of RoHS restricted materials in this product are below the maximum concentration values (also referred to as the threshold limits) permitted for such substances, or are used in an exempted application, in accordance with EU Directive 2011/65/EC (RoHS2), as implemented January 2, 2013. RoHS Declarations for this product can be obtained from your Cree representative or from the Product Documentation sections of www.cree.com.

REACH Compliance

REACH substances of very high concern (SVHCs) information is available for this product. Since the European Chemical Agency (ECHA) has published notice of their intent to frequently revise the SVHC listing for the foreseeable future, please contact a Cree representative to insure you get the most up-to-date REACH SVHC Declaration. REACH banned substance information (REACH Article 67) is also available upon request.

UL® Recognized Component

Level 4 enclosure consideration. The LED package or a portion thereof has been investigated as a fire and electrical enclosure per ANSI/UL 8750.

NOTES - CONTINUED

Vision Advisory

WARNING: Do not look at exposed lamp in operation. Eye injury can result. For more information about LEDs and eye safety, please refer to the [LED Eye Safety application note](#).

MECHANICAL DIMENSIONS

Thermal vias, if present, are not shown on these drawings.

All measurements are $\pm .13$ mm unless otherwise indicated.

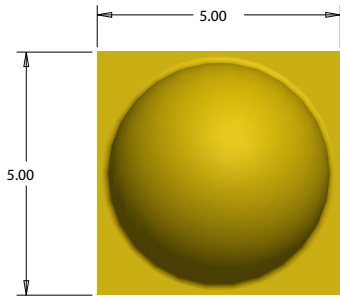

Top View

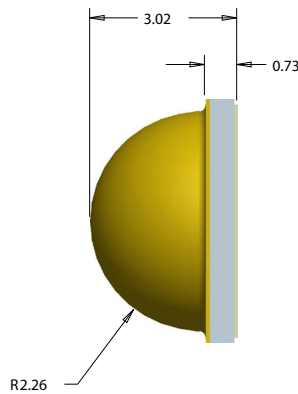

Side View

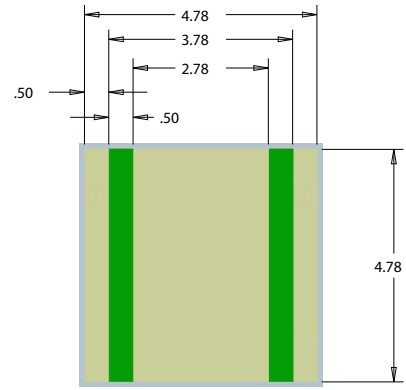

Bottom View

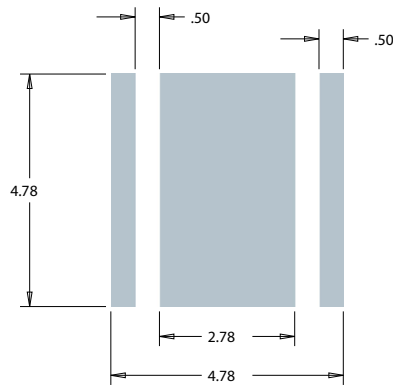

Recommended PCB Solder Pad

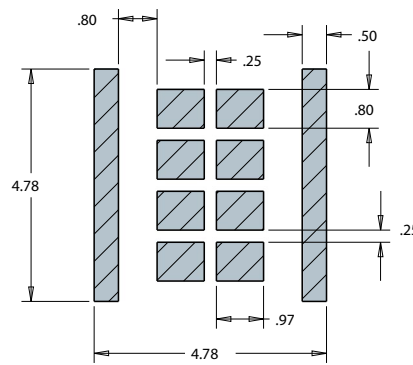

**Recommended Stencil Pattern
(Shaded Area Is Open)**

TAPE AND REEL

All Cree carrier tapes conform to EIA-481D, Automated Component Handling Systems Standard.

Except as noted, all dimensions in mm.

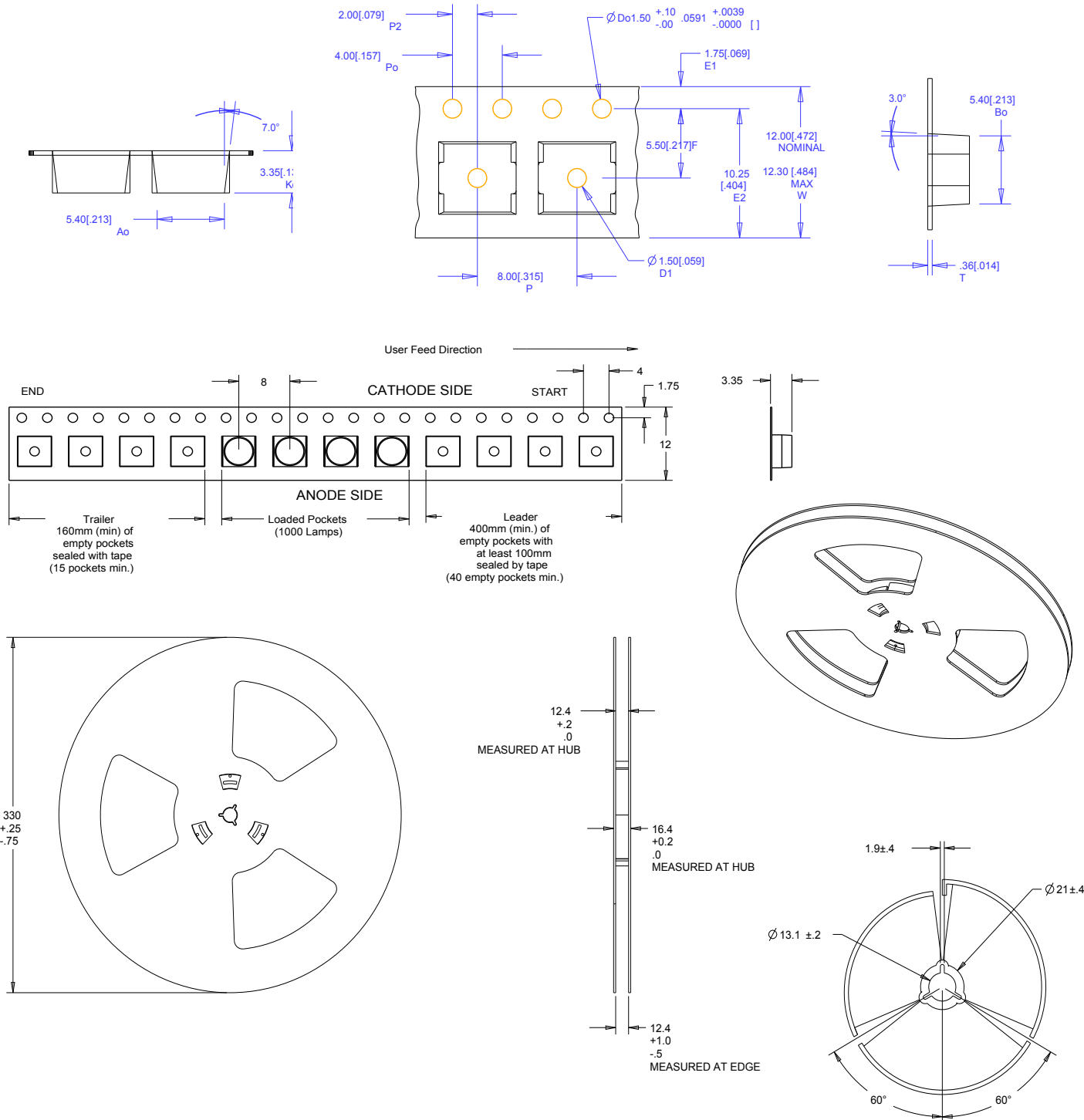

PACKAGING

Unpackaged Reel

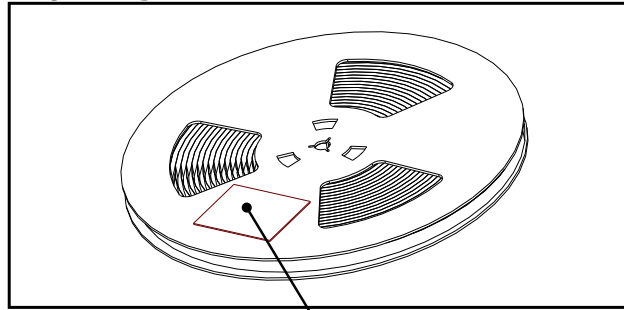

Label with Cree Bin Code,
Quantity, Reel ID

Packaged Reel

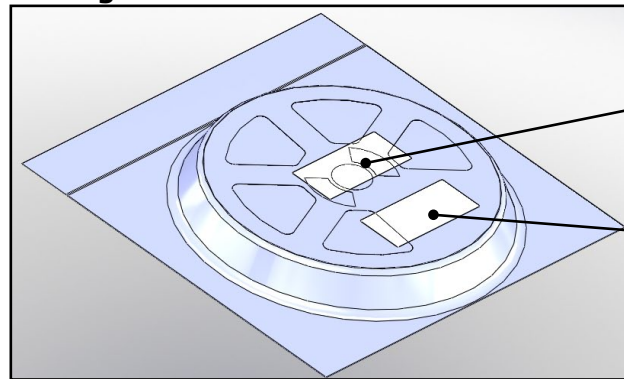

Label with Cree Order Code,
Quantity, Reel ID, PO #

Label with Cree Bin Code,
Quantity, Reel ID

Boxed Reel

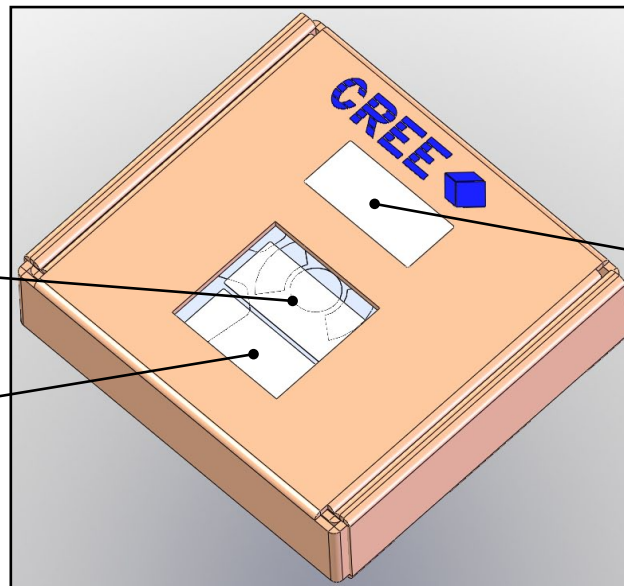

Patent Label

Label with Cree Order Code,
Quantity, Reel ID, PO #

Label with Cree Bin Code,
Quantity, Reel ID



Компания «ЭлектроПласт» предлагает заключение долгосрочных отношений при поставках импортных электронных компонентов на взаимовыгодных условиях!

Наши преимущества:

- Оперативные поставки широкого спектра электронных компонентов отечественного и импортного производства напрямую от производителей и с крупнейших мировых складов;
- Поставка более 17-ти миллионов наименований электронных компонентов;
- Поставка сложных, дефицитных, либо снятых с производства позиций;
- Оперативные сроки поставки под заказ (от 5 рабочих дней);
- Экспресс доставка в любую точку России;
- Техническая поддержка проекта, помощь в подборе аналогов, поставка прототипов;
- Система менеджмента качества сертифицирована по Международному стандарту ISO 9001;
- Лицензия ФСБ на осуществление работ с использованием сведений, составляющих государственную тайну;
- Поставка специализированных компонентов (Xilinx, Altera, Analog Devices, Intersil, Interpoint, Microsemi, Aeroflex, Peregrine, Syfer, Eurofarad, Texas Instrument, Miteq, Cobham, E2V, MA-COM, Hittite, Mini-Circuits, General Dynamics и др.);

Помимо этого, одним из направлений компании «ЭлектроПласт» является направление «Источники питания». Мы предлагаем Вам помощь Конструкторского отдела:

- Подбор оптимального решения, техническое обоснование при выборе компонента;
- Подбор аналогов;
- Консультации по применению компонента;
- Поставка образцов и прототипов;
- Техническая поддержка проекта;
- Защита от снятия компонента с производства.



Как с нами связаться

Телефон: 8 (812) 309 58 32 (многоканальный)

Факс: 8 (812) 320-02-42

Электронная почта: org@eplast1.ru

Адрес: 198099, г. Санкт-Петербург, ул. Калинина, дом 2, корпус 4, литера А.