

Automotive turbo 2 ultrafast high voltage rectifier

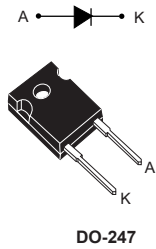

Features

- AEC-Q101 qualified
- High junction temperature capability
- Ultrafast with soft recovery behavior
- Low reverse current
- Low thermal resistance
- Reduced switching and conduction losses
- PPAP capable

Description

The **STTH60RQ06-Y** has been developed for applications requiring a high-voltage secondary rectification for LLC full bridge topology.

Also it is ideal for switching power supplies, industrial and automotive applications, as rectification, freewheeling and clamping diode.

Product status link	
STTH60RQ06-Y	
Product summary	
Symbol	Value
$I_{F(AV)}$	60 A
V_{RRM}	600 V
$V_{F(max)}$	1.45 V
$t_{rr(max)}$	35 ns
T_j	-40 to +175 °C

1 Characteristics

Table 1. Absolute ratings (limiting values at 25 °C, unless otherwise specified)

Symbol	Parameter		Value	Unit
V_{RRM}	Repetitive peak reverse voltage ($T_j = -40\text{ °C to }+175\text{ °C}$)		600	V
$I_{F(RMS)}$	Forward rms current		90	A
$I_{F(AV)}$	Average forward current		60	A
I_{FSM}	Surge non repetitive forward current	$t_p = 10\text{ ms sinusoidal}$	425	A
T_{stg}	Storage temperature range		-65 to +175	°C
T_j	Operating junction temperature range		-40 to +175	°C

Table 2. Thermal resistance parameters

Symbol	Parameter	Max.	Unit
$R_{th(j-c)}$	Junction to case	0.38	°C/W

Table 3. Static electrical characteristics

Symbol	Parameter	Test conditions		Min.	Typ.	Max.	Unit
$I_R^{(1)}$	Reverse leakage current	$T_j = 25\text{ °C}$	$V_R = V_{RRM}$	-		80	μA
		$T_j = 150\text{ °C}$		-	160	1600	
$V_F^{(2)}$	Forward voltage drop	$T_j = 25\text{ °C}$	$I_F = 30\text{ A}$	-		2.45	V
		$T_j = 150\text{ °C}$		-	1.15	1.45	
		$T_j = 25\text{ °C}$	$I_F = 60\text{ A}$	-		2.95	
		$T_j = 150\text{ °C}$		-	1.45	1.85	

1. Pulse test: $t_p = 5\text{ ms}$, $\delta < 2\%$

2. Pulse test: $t_p = 380\text{ }\mu\text{s}$, $\delta < 2\%$

To evaluate the conduction losses, use the following equation:

$$P = 1.05 \times I_{F(AV)} + 0.013 \times I_{F(RMS)}^2$$

Table 4. Dynamic electrical characteristics

Symbol	Parameter	Test conditions			Min.	Typ.	Max.	Unit
t_{rr}	Reverse recovery time	$T_j = 25\text{ °C}$	$I_F = 0.5\text{ A}$, $I_{rr} = 0.25\text{ A}$, $I_R = 1\text{ A}$		-		35	ns
			$I_F = 1\text{ A}$, $V_R = 30\text{ V}$, $di_F/dt = -50\text{ A}/\mu\text{s}$		-	50	65	
I_{RM}	Reverse recovery current	$T_j = 125\text{ °C}$	$I_F = 60\text{ A}$, $V_R = 400\text{ V}$, $di_F/dt = -200\text{ A}/\mu\text{s}$		-	12	16	A
Q_{rr}	Reverse recovery charge				-	660		nC
t_{rr}	Reverse recovery time				-	92		ns

1.1 Characteristics (curves)

Figure 1. Average forward power dissipation versus average forward current (square waveform)

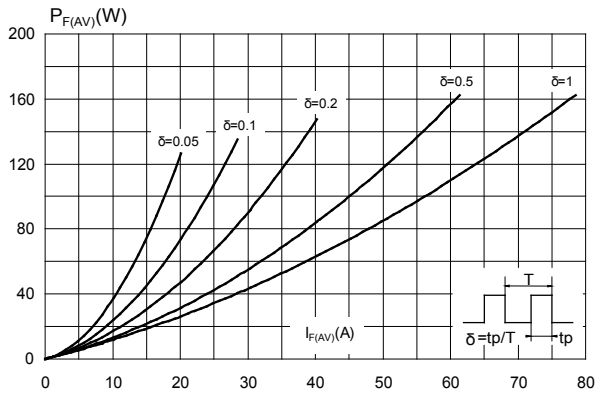

Figure 2. Average forward power dissipation versus average forward current (sinusoidal waveform)

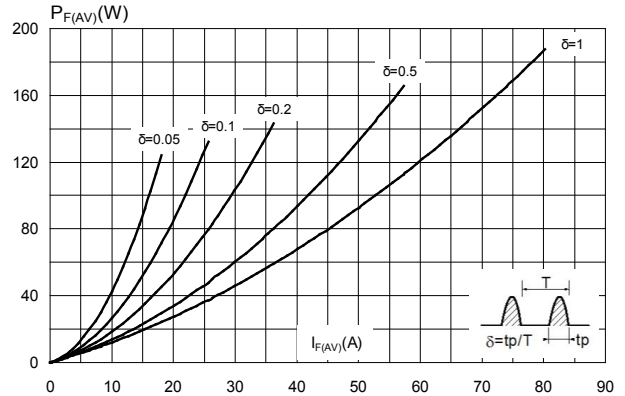

Figure 3. Forward voltage drop versus forward current (typical values)

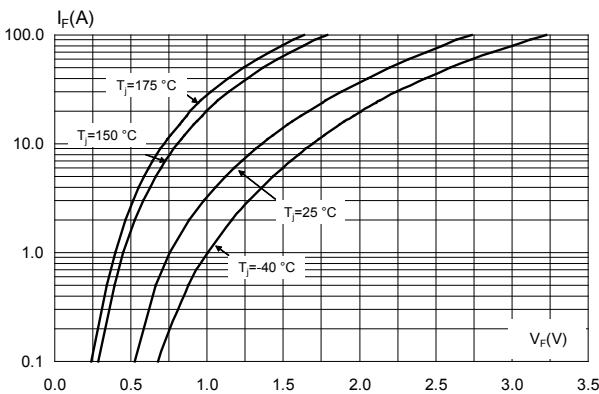

Figure 4. Forward voltage drop versus forward current (maximum values)

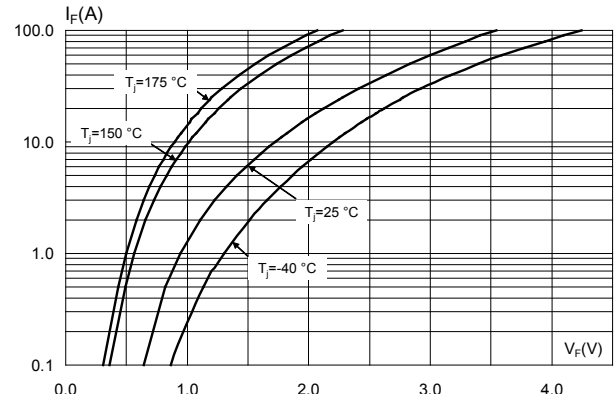

Figure 5. Relative variation of thermal impedance junction to case versus pulse duration

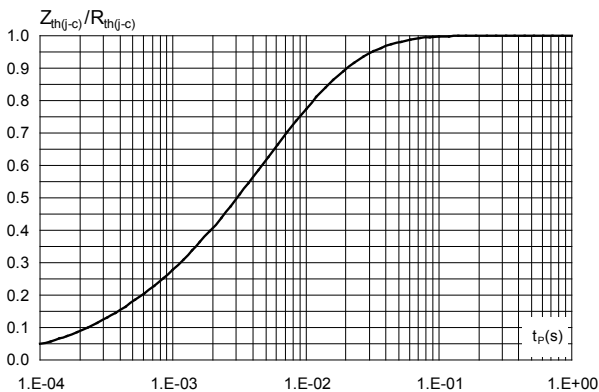

Figure 6. Peak reverse recovery current versus di_F/dt (typical values)

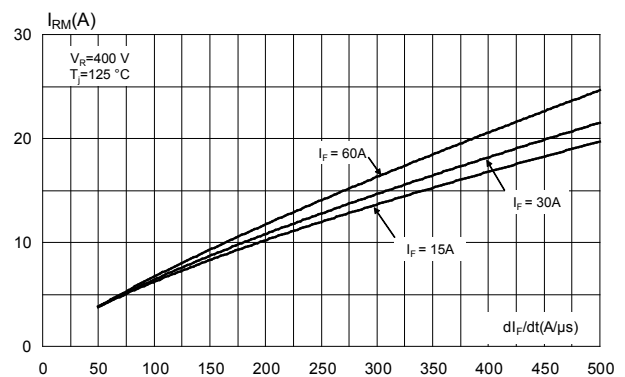

Figure 7. Reverse recovery time versus di_F/dt (typical values)

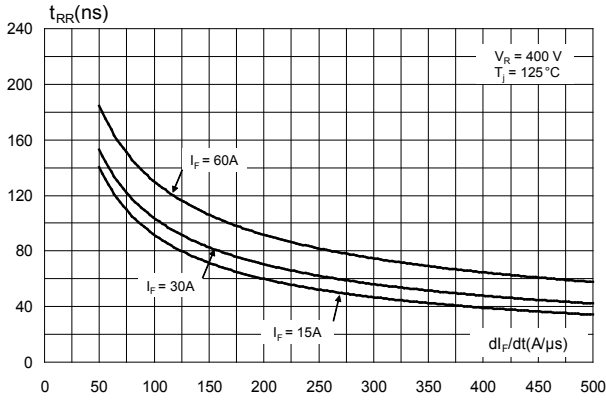

Figure 8. Reverse recovery charges versus di_F/dt (typical values)

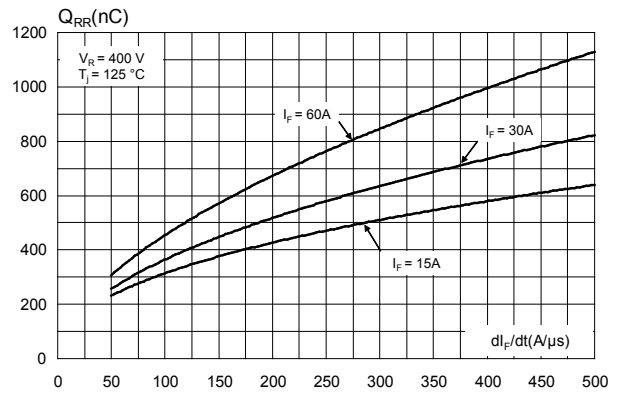

Figure 9. Reverse recovery softness factor versus di_F/dt (typical values)

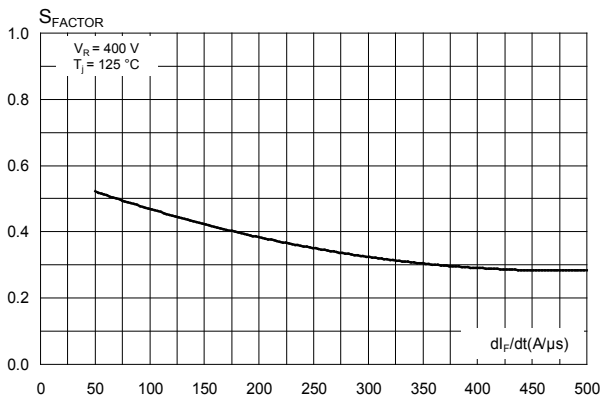

Figure 10. Relative variations of dynamic parameters versus junction temperature

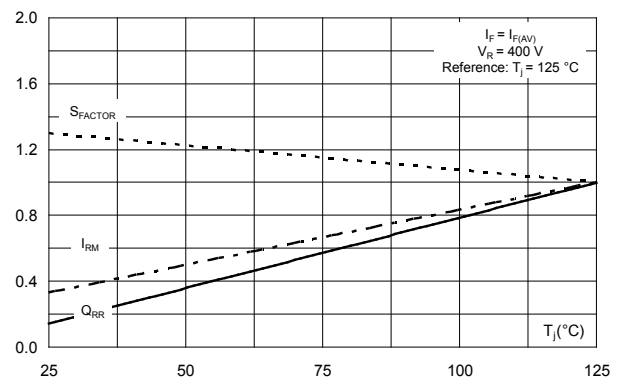

Figure 11. Junction capacitance versus reverse voltage applied (typical values)

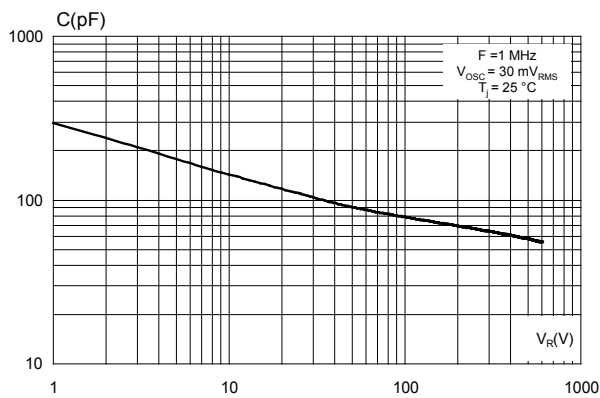

Figure 12. Relative variation of non-repetitive peak surge forward current versus pulse duration (sinusoidal waveform)

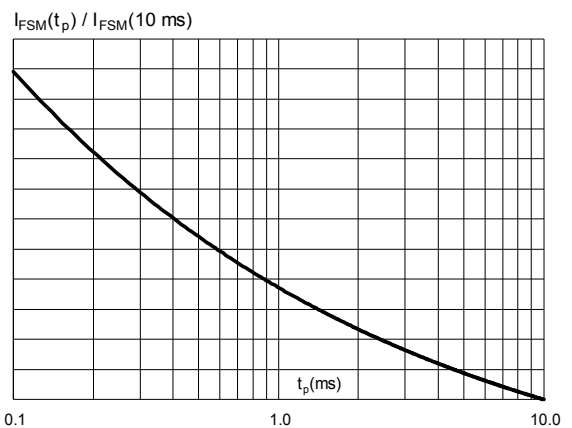
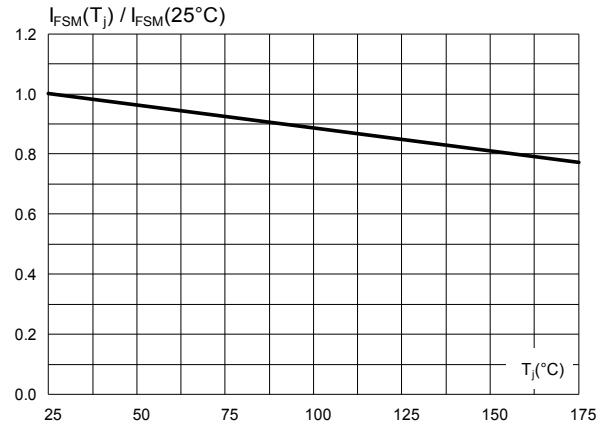

Figure 13. Relative variation of non-repetitive peak surge forward current versus initial junction temperature (sinusoidal waveform)



2 Package information

In order to meet environmental requirements, ST offers these devices in different grades of ECOPACK® packages, depending on their level of environmental compliance. ECOPACK® specifications, grade definitions and product status are available at: www.st.com. ECOPACK® is an ST trademark.

2.1 [Package name] package information

- Epoxy meets UL94, V0
- Cooling method: by conduction (C)
- Recommended torque value: 0.8 N·m (DO-247)
- Maximum torque value: 1.0 N·m (DO-247)

Figure 14. DO-247 package outline

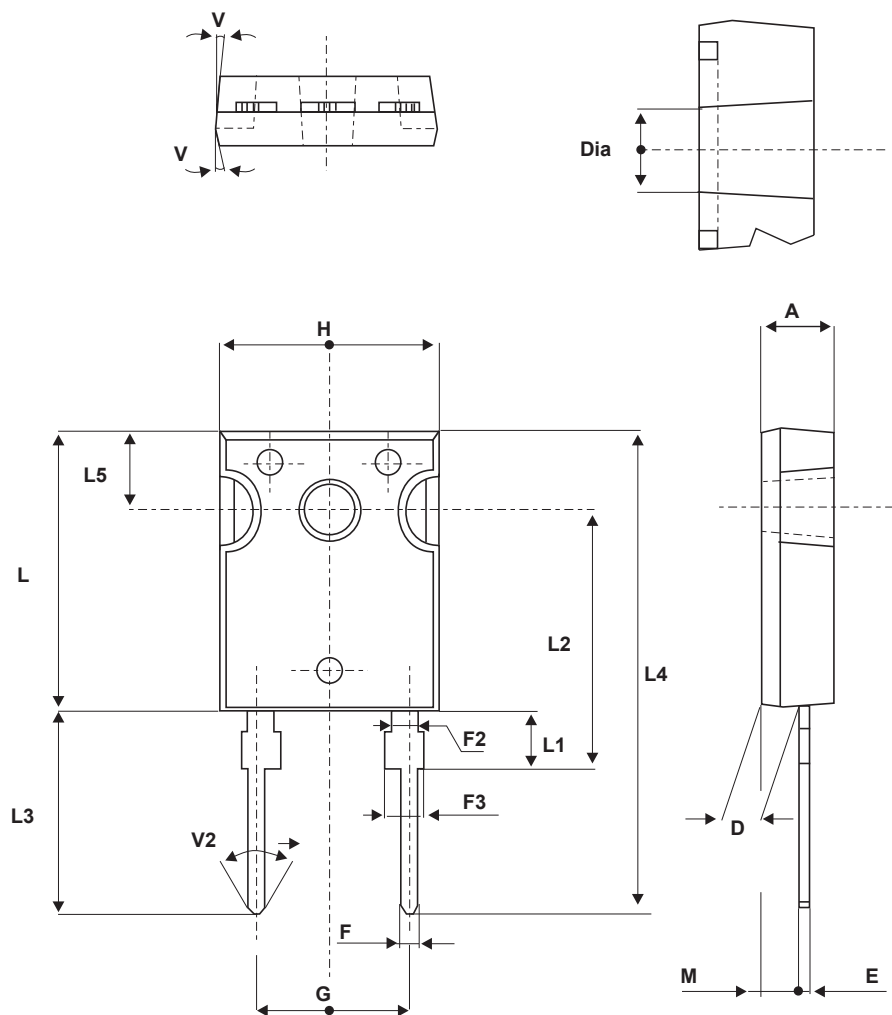

Table 5. DO-247 package mechanical data

Ref.	Dimensions			
	Millimeters		Inches	
	Min.	Max.	Min.	Max.
A	4.85	5.15	0.191	0.203
D	2.20	2.60	0.086	0.102
E	0.40	0.80	0.015	0.031
F	1.00	1.40	0.039	0.055
F2	2.00 typ.		0.078 typ.	
F3	2.00	2.40	0.078	0.094
G	10.90 typ.		0.429 typ.	
H	15.45	15.75	0.608	0.620
L	19.85	20.15	0.781	0.793
L1	3.70	4.30	0.145	0.169
L2	18.50 typ.		0.728 typ.	
L3	14.20	14.80	0.559	0.582
L4	34.60 typ.		1.362 typ.	
L5	5.50 typ.		0.216 typ.	
M	2.00	3.00	0.078	0.118
V	5°		5°	
V2	60°		60°	
Dia.	3.55	3.65	0.139	0.143

3 Ordering information

Table 6. Ordering information

Order code	Marking	Package	Weight	Base qty.	Delivery mode
STTH60RQ06WY	STTH60RQ06WY	DO-247	4.40 g	30	Tube

Revision history

Table 7. Document revision history

Date	Version	Changes
20-Mar-2018	1	Initial release.
05-Apr-2018	2	Updated Section • Features . Minor text changes to improve readability.

IMPORTANT NOTICE – PLEASE READ CAREFULLY

STMicroelectronics NV and its subsidiaries (“ST”) reserve the right to make changes, corrections, enhancements, modifications, and improvements to ST products and/or to this document at any time without notice. Purchasers should obtain the latest relevant information on ST products before placing orders. ST products are sold pursuant to ST’s terms and conditions of sale in place at the time of order acknowledgement.

Purchasers are solely responsible for the choice, selection, and use of ST products and ST assumes no liability for application assistance or the design of Purchasers’ products.

No license, express or implied, to any intellectual property right is granted by ST herein.

Resale of ST products with provisions different from the information set forth herein shall void any warranty granted by ST for such product.

ST and the ST logo are trademarks of ST. All other product or service names are the property of their respective owners.

Information in this document supersedes and replaces information previously supplied in any prior versions of this document.

© 2018 STMicroelectronics – All rights reserved



Компания «ЭлектроПласт» предлагает заключение долгосрочных отношений при поставках импортных электронных компонентов на взаимовыгодных условиях!

Наши преимущества:

- Оперативные поставки широкого спектра электронных компонентов отечественного и импортного производства напрямую от производителей и с крупнейших мировых складов;
- Поставка более 17-ти миллионов наименований электронных компонентов;
- Поставка сложных, дефицитных, либо снятых с производства позиций;
- Оперативные сроки поставки под заказ (от 5 рабочих дней);
- Экспресс доставка в любую точку России;
- Техническая поддержка проекта, помощь в подборе аналогов, поставка прототипов;
- Система менеджмента качества сертифицирована по Международному стандарту ISO 9001;
- Лицензия ФСБ на осуществление работ с использованием сведений, составляющих государственную тайну;
- Поставка специализированных компонентов (Xilinx, Altera, Analog Devices, Intersil, Interpoint, Microsemi, Aeroflex, Peregrine, Syfer, Eurofarad, Texas Instrument, Miteq, Cobham, E2V, MA-COM, Hittite, Mini-Circuits, General Dynamics и др.);

Помимо этого, одним из направлений компании «ЭлектроПласт» является направление «Источники питания». Мы предлагаем Вам помощь Конструкторского отдела:

- Подбор оптимального решения, техническое обоснование при выборе компонента;
- Подбор аналогов;
- Консультации по применению компонента;
- Поставка образцов и прототипов;
- Техническая поддержка проекта;
- Защита от снятия компонента с производства.



Как с нами связаться

Телефон: 8 (812) 309 58 32 (многоканальный)

Факс: 8 (812) 320-02-42

Электронная почта: org@eplast1.ru

Адрес: 198099, г. Санкт-Петербург, ул. Калинина, дом 2, корпус 4, литера А.