

FDD9507L-F085

P-Channel **POWERTRENCH**[®] MOSFET

-40 V, -100 A, 4.4 mΩ

Features

- Typical $R_{DS(on)}$ = 3.3 mΩ at $V_{GS} = -10$ V, $I_D = -80$ A
- Typical $G_{g(tot)}$ = 110 nC at $V_{GS} = -10$ V, $I_D = -80$ A
- UIS Capability
- Qualified to AEC Q101
- These Devices are Pb-Free, Halogen Free/BFR Free and are RoHS Compliant

Applications

- Automotive Engine Control
- PowerTrain Management
- Solenoid and Motor Drivers
- Electrical Power Steering
- Integrated Starter/Alternator
- Distributed Power Architectures and VRM
- Primary Switch for 12 V Systems

MAXIMUM RATINGS ($T_A = 25^\circ\text{C}$ unless otherwise noted)

| Symbol | Parameter | Value | Unit |
|----------------|---|----------------|---------------------|
| V_{DSS} | Drain-to-Source Voltage | -40 | V |
| V_{GS} | Gate-to-Source Voltage | ±16 | V |
| I_D | Drain Current – Continuous, ($V_{GS} = -10$ V) $T_C = 25^\circ\text{C}$ (Note 1) | -100 | A |
| | Pulsed Drain Current, $T_C = 25^\circ\text{C}$ | (See Figure 4) | A |
| E_{AS} | Single Pulse Avalanche Energy (Note 2) | 259 | mJ |
| P_D | Power Dissipation | 227 | W |
| | Derate Above 25°C | 1.52 | W/ $^\circ\text{C}$ |
| T_J, T_{STG} | Operating and Storage Temperature | -55 to +175 | $^\circ\text{C}$ |

Stresses exceeding those listed in the Maximum Ratings table may damage the device. If any of these limits are exceeded, device functionality should not be assumed, damage may occur and reliability may be affected.

1. Current is limited by bondwire configuration.
2. Starting $T_J = 25^\circ\text{C}$, $L = 0.1$ mH, $I_{AS} = -72$ A, $V_{DD} = -40$ V during inductor charging and $V_{DD} = 0$ V during time in avalanche.



ON Semiconductor[®]

www.onsemi.com

| V_{DSS} | $R_{DS(ON)}$ MAX | I_D MAX |
|-----------|------------------|-----------|
| -40 V | 4.4 mΩ @ -10 V | -100 A |

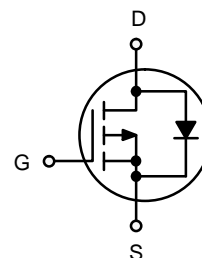

P-CHANNEL MOSFET

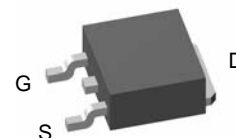

**DPAK3 (TO-252)
CASE 369AS**

MARKING DIAGRAM

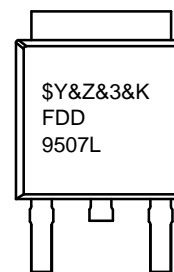

| | |
|----------|-------------------------|
| \$Y | = ON Semiconductor Logo |
| &Z | = Assembly Plant Code |
| &3 | = Numeric Date Code |
| &K | = Lot Code |
| FDD9507L | = Specific Device Code |

ORDERING INFORMATION

See detailed ordering and shipping information on page 7 of this data sheet.

FDD9507L-F085

THERMAL CHARACTERISTICS

| Symbol | Parameter | Value | Unit |
|-----------------|--|-------|------|
| $R_{\theta JC}$ | Thermal Resistance, Junction to Case | 0.66 | °C/W |
| $R_{\theta JA}$ | Thermal Resistance, Junction to Ambient (Note 3) | 52 | |

3. $R_{\theta JA}$ is the sum of the junction-to-case and case-to-ambient thermal resistance, where the case thermal reference is defined as the solder mounting surface of the drain pins. $R_{\theta JC}$ is guaranteed by design, while $R_{\theta JA}$ is determined by the board design. The maximum rating presented here is based on mounting on a 1 in² pad of 2oz copper.

ELECTRICAL CHARACTERISTICS (T_J = 25°C unless otherwise noted)

| Symbol | Parameter | Test Condition | Min | Typ | Max | Unit |
|--------|-----------|----------------|-----|-----|-----|------|
|--------|-----------|----------------|-----|-----|-----|------|

OFF CHARACTERISTICS

| | | | | | | |
|------------|-----------------------------------|--|-----|---|------|---------------|
| BV_{DSS} | Drain-to-Source Breakdown Voltage | $I_D = -250 \mu A, V_{GS} = 0 V$ | -40 | - | - | V |
| I_{DSS} | Drain-to-Source Leakage Current | $V_{DS} = -40 V, V_{GS} = 0 V$ $T_J = 25^\circ C$ $T_J = 175^\circ C$ (Note 4) | - | - | 1 | μA mA |
| I_{GSS} | Gate-to-Source Leakage Current | $V_{GS} = \pm 16 V$ | - | - | ±100 | nA |

ON CHARACTERISTICS

| | | | | | | |
|--------------|--------------------------------------|---|----|-----|-----|----|
| $V_{GS(th)}$ | Gate to Source Threshold Voltage | $V_{GS} = V_{DS}, I_D = 250 \mu A$ | -1 | -2 | -3 | V |
| $R_{DS(on)}$ | Static Drain to Source On Resistance | $V_{GS} = -4.5 V, I_D = -80 A, T_J = 25^\circ C$ | - | 4.9 | 7.2 | mΩ |
| | | $V_{GS} = -10 V, I_D = -80 A$ $T_J = 25^\circ C$ $T_J = 175^\circ C$ (Note 4) | - | 3.3 | 4.4 | |
| | | | - | 5.3 | 7.1 | |

DYNAMIC CHARACTERISTICS

| | | | | | | |
|---------------|-------------------------------|---|---|------|-----|----|
| C_{iss} | Input Capacitance | $V_{DS} = -20 V, V_{GS} = 0 V, f = 1 MHz$ | - | 6250 | - | pF |
| C_{oss} | Output Capacitance | | - | 2640 | - | pF |
| C_{rss} | Reverse Transfer Capacitance | | - | 61 | - | pF |
| R_g | Gate Resistance | $f = 1 MHz$ | - | 19.3 | - | Ω |
| $Q_{g(tot)}$ | Total Gate Charge | $V_{GS} = 0 V$ to $-10 V, V_{DD} = -20 V, I_D = -80 A$ | - | 100 | 130 | nC |
| $Q_{g(-4.5)}$ | Total Gate Charge | $V_{GS} = 0 V$ to $-4.5 V, V_{DD} = -20 V, I_D = -80 A$ | - | 46 | - | nC |
| $Q_{g(th)}$ | Threshold Gate Charge | $V_{GS} = 0 V$ to $-2 V, V_{DD} = -20 V, I_D = -80 A$ | - | 13 | - | nC |
| Q_{gs} | Gate to Source Charge | $V_{DD} = -20 V, I_D = -80 A$ | - | 22 | - | nC |
| Q_{gd} | Gate to Drain "Miller" Charge | $V_{DD} = -20 V, I_D = -80 A$ | - | 13 | - | nC |

SWITCHING CHARACTERISTICS

| | | | | | | |
|--------------|----------------|--|---|-----|-----|----|
| t_{on} | Turn-On Time | $V_{DD} = -20 V, I_D = -80 A, V_{GS} = -10 V,$ $R_{GEN} = 6 \Omega$ | - | - | 21 | ns |
| $t_{d(on)}$ | Turn-On Delay | | - | 10 | - | ns |
| t_r | Rise Time | | - | 6 | - | ns |
| $t_{d(off)}$ | Turn-Off Delay | | - | 400 | - | ns |
| t_f | Fall Time | | - | 132 | - | ns |
| t_{off} | Turn-Off Time | | - | - | 710 | ns |

DRAIN-SOURCE DIODE CHARACTERISTICS

| | | | | | | |
|----------|---------------------------------------|---|---|-------|------|----|
| V_{SD} | Source to Drain Diode Forward Voltage | $I_{SD} = -80 A, V_{GS} = 0 V$ | - | -0.9 | -1.3 | V |
| | | $I_{SD} = -40 A, V_{GS} = 0 V$ | - | -0.85 | -1.2 | |
| t_{rr} | Reverse Recovery Time | $I_F = -80 A, di_{SD}/dt = 100 A/\mu s$ | - | 87 | 113 | ns |
| Q_{rr} | Reverse Recovery Charge | | - | 115 | 150 | nC |

Product parametric performance is indicated in the Electrical Characteristics for the listed test conditions, unless otherwise noted. Product performance may not be indicated by the Electrical Characteristics if operated under different conditions.

4. The maximum value is specified by design at T_J = 175°C. Product is not tested to this condition in production.

TYPICAL CHARACTERISTICS

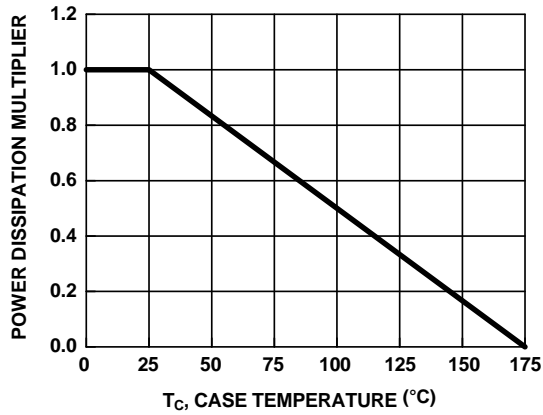

Figure 1. Normalized Power Dissipation vs. Case Temperature

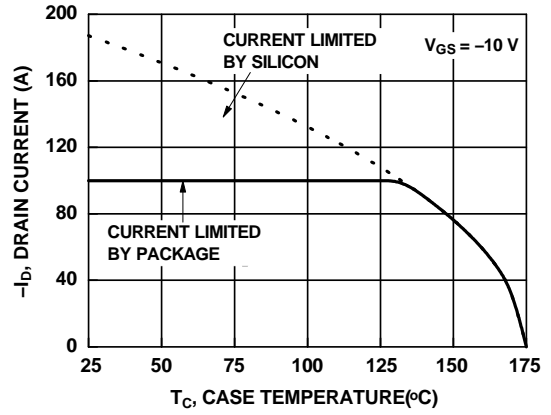

Figure 2. Maximum Continuous Drain Current vs. Case Temperature

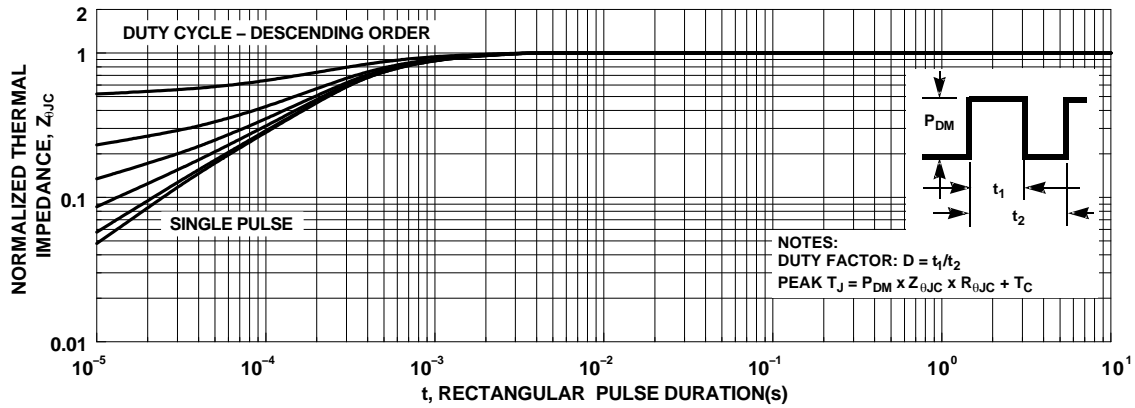

Figure 3. Normalized Maximum Transient Thermal Impedance

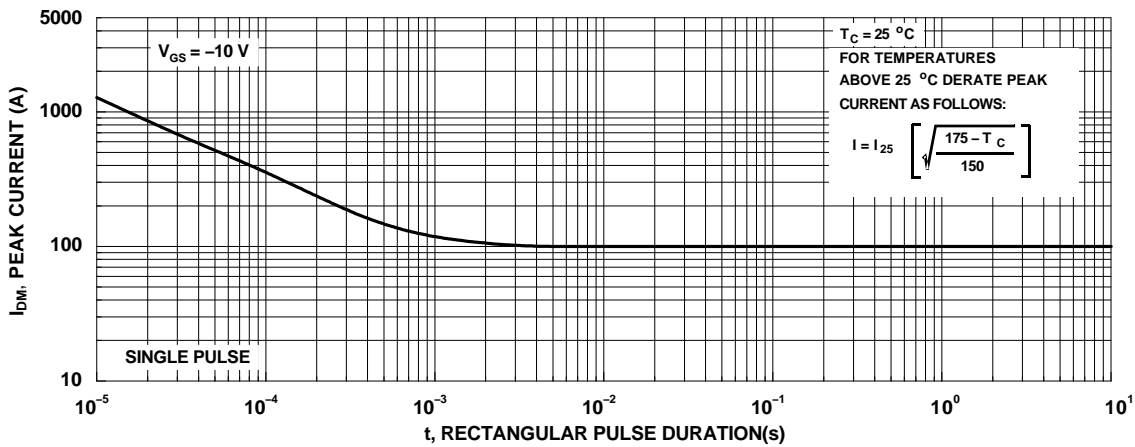

Figure 4. Peak Current Capability

TYPICAL CHARACTERISTICS

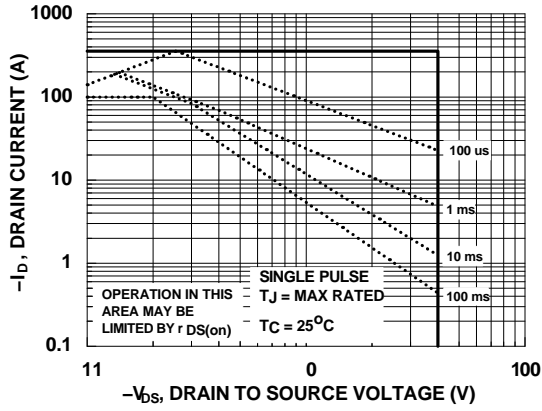

Figure 5. Forward Bias Safe Operating Area

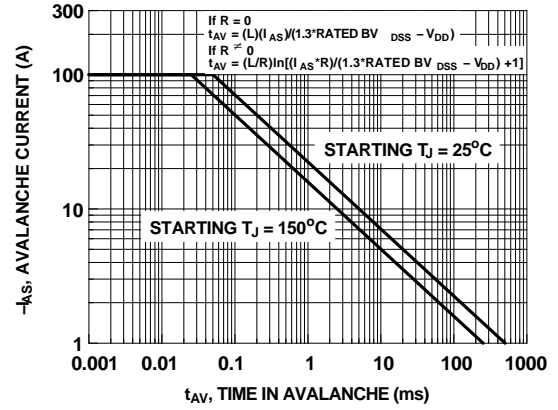

Figure 6. Unclamped Inductive Switching Capability

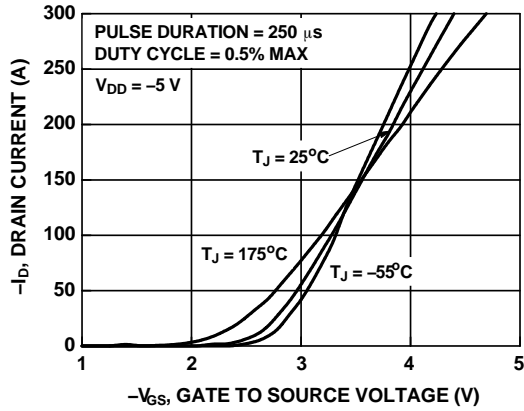

Figure 7. Transfer Characteristics

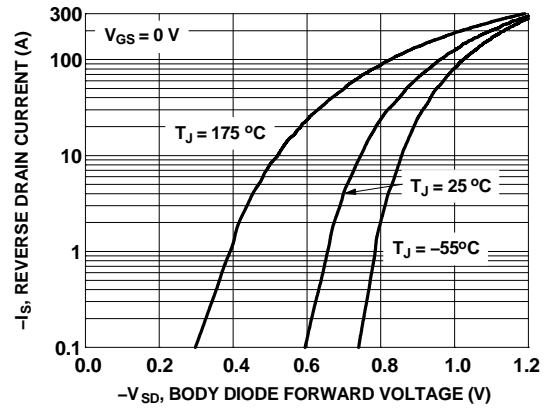

Figure 8. Forward Diode Characteristics

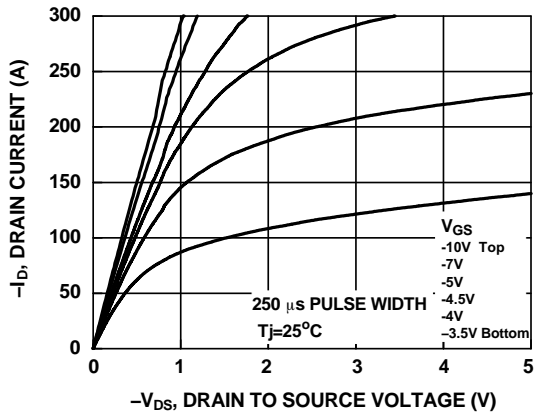

Figure 9. Saturation Characteristics

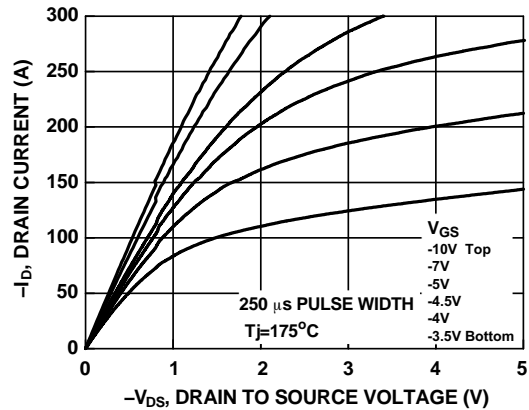

Figure 10. Saturation Characteristics

TYPICAL CHARACTERISTICS

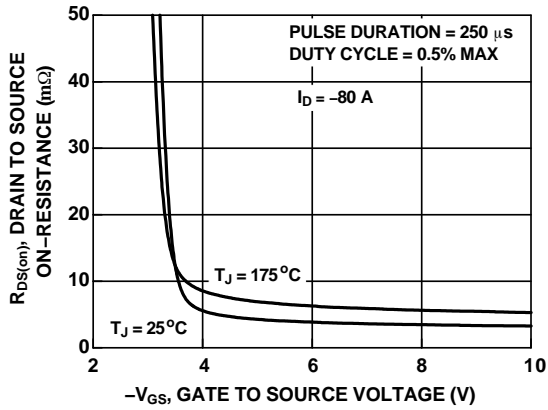

Figure 11. $R_{DS(on)}$ vs. Gate Voltage

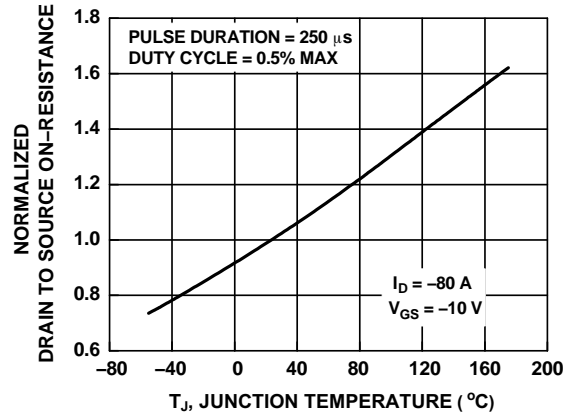

Figure 12. Normalized $R_{DS(on)}$ vs. Junction Temperature

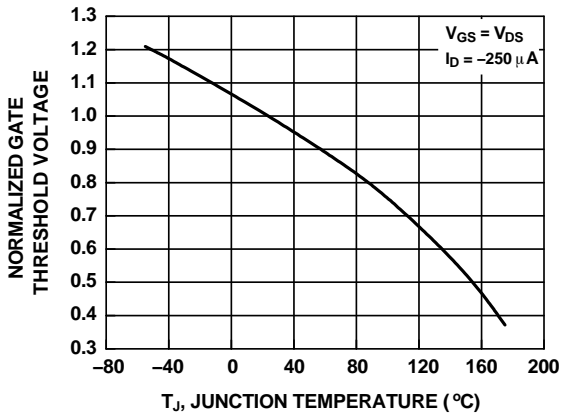

Figure 13. Normalized Gate Threshold Voltage vs. Temperature

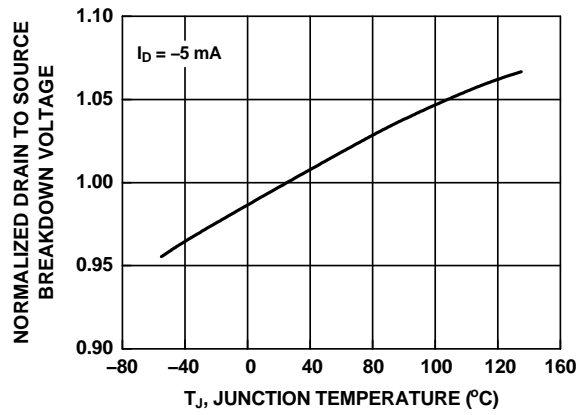

Figure 14. Normalized Drain to Source Breakdown Voltage vs. Junction Temperature

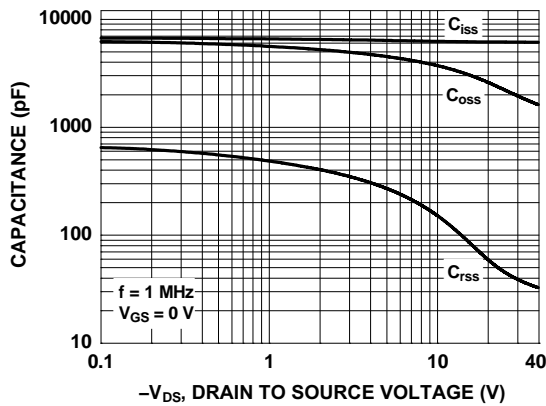

Figure 15. Capacitance vs. Drain to Source Voltage

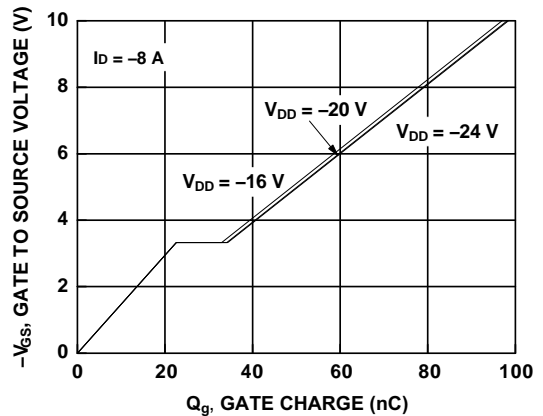
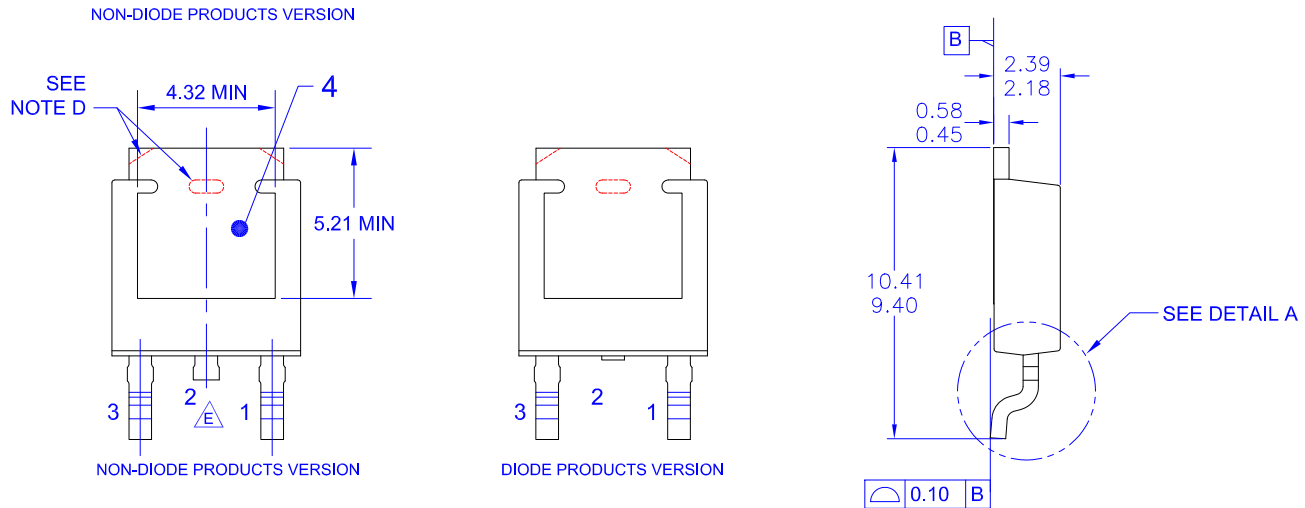
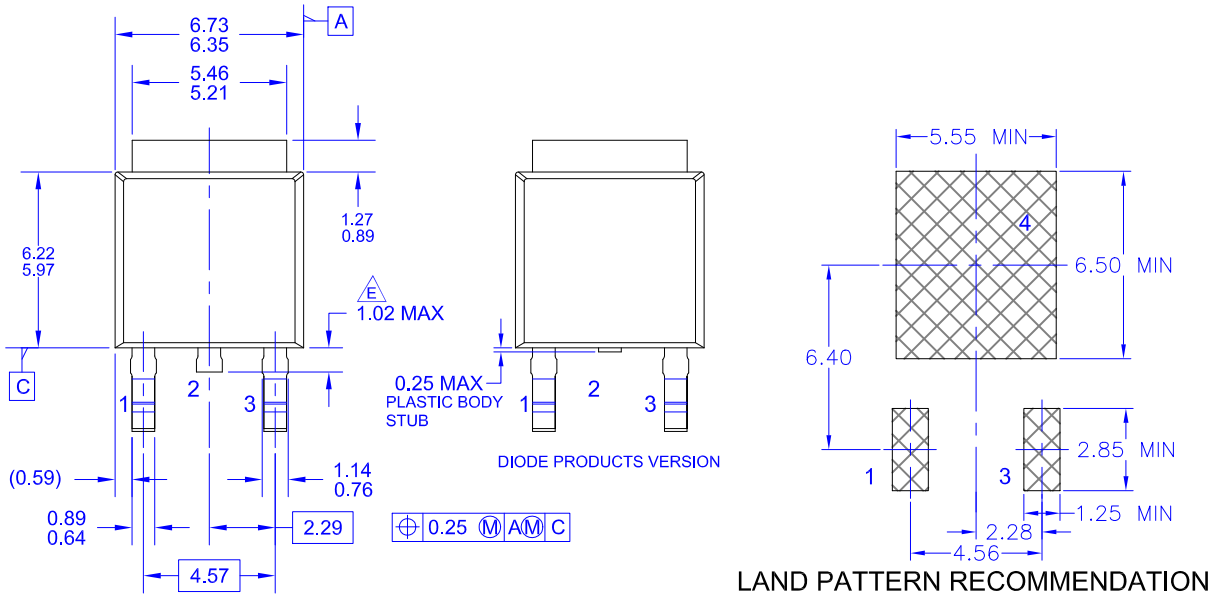

Figure 16. Gate Charge vs. Gate to Source Voltage

FDD9507L-F085

PACKAGE DIMENSIONS

DPAK3 (TO-252 3 LD) CASE 369AS ISSUE O



- NOTES: UNLESS OTHERWISE SPECIFIED
- A) THIS PACKAGE CONFORMS TO JEDEC, TO-252, ISSUE C, VARIATION AA.
 - B) ALL DIMENSIONS ARE IN MILLIMETERS.
 - C) DIMENSIONING AND TOLERANCING PER ASME Y14.5M-2009.
 - D) SUPPLIER DEPENDENT MOLD LOCKING HOLES OR CHAMFERED CORNERS OR EDGE PROTRUSION.
 - E) TRIMMED CENTER LEAD IS PRESENT ONLY FOR DIODE PRODUCTS
 - F) DIMENSIONS ARE EXCLUSIVE OF BURRS, MOLD FLASH AND TIE BAR EXTRUSIONS.
 - G) LAND PATTERN RECOMMENDATION IS BASED ON IPC7351A STD TO228P991X239-3N.

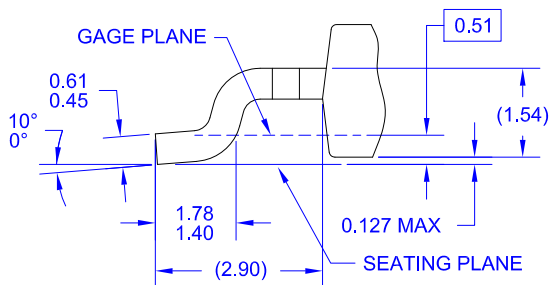

FDD9507L-F085

ORDERING INFORMATION

| Device | Marking | Package | Reel Size | Tape Width | Quantity |
|---------------|----------|--|-----------|------------|------------|
| FDD9507L-F085 | FDD9507L | DPAK3 (TO-252) (Pb-Free / Halogen Free) | 13" | 16 mm | 2500 Units |

POWERTRENCH is registered trademark of Semiconductor Components Industries, LLC (SCILLC) or its subsidiaries in the United States and/or other countries.

ON Semiconductor and  are trademarks of Semiconductor Components Industries, LLC dba ON Semiconductor or its subsidiaries in the United States and/or other countries. ON Semiconductor owns the rights to a number of patents, trademarks, copyrights, trade secrets, and other intellectual property. A listing of ON Semiconductor's product/patent coverage may be accessed at www.onsemi.com/site/pdf/Patent-Marking.pdf. ON Semiconductor reserves the right to make changes without further notice to any products herein. ON Semiconductor makes no warranty, representation or guarantee regarding the suitability of its products for any particular purpose, nor does ON Semiconductor assume any liability arising out of the application or use of any product or circuit, and specifically disclaims any and all liability, including without limitation special, consequential or incidental damages. Buyer is responsible for its products and applications using ON Semiconductor products, including compliance with all laws, regulations and safety requirements or standards, regardless of any support or applications information provided by ON Semiconductor. "Typical" parameters which may be provided in ON Semiconductor data sheets and/or specifications can and do vary in different applications and actual performance may vary over time. All operating parameters, including "Typicals" must be validated for each customer application by customer's technical experts. ON Semiconductor does not convey any license under its patent rights nor the rights of others. ON Semiconductor products are not designed, intended, or authorized for use as a critical component in life support systems or any FDA Class 3 medical devices or medical devices with a same or similar classification in a foreign jurisdiction or any devices intended for implantation in the human body. Should Buyer purchase or use ON Semiconductor products for any such unintended or unauthorized application, Buyer shall indemnify and hold ON Semiconductor and its officers, employees, subsidiaries, affiliates, and distributors harmless against all claims, costs, damages, and expenses, and reasonable attorney fees arising out of, directly or indirectly, any claim of personal injury or death associated with such unintended or unauthorized use, even if such claim alleges that ON Semiconductor was negligent regarding the design or manufacture of the part. ON Semiconductor is an Equal Opportunity/Affirmative Action Employer. This literature is subject to all applicable copyright laws and is not for resale in any manner.

PUBLICATION ORDERING INFORMATION

LITERATURE FULFILLMENT:

Literature Distribution Center for ON Semiconductor
19521 E. 32nd Pkwy, Aurora, Colorado 80011 USA
Phone: 303-675-2175 or 800-344-3860 Toll Free USA/Canada
Fax: 303-675-2176 or 800-344-3867 Toll Free USA/Canada
Email: orderlit@onsemi.com

N. American Technical Support: 800-282-9855 Toll Free
USA/Canada
Europe, Middle East and Africa Technical Support:
Phone: 421 33 790 2910

ON Semiconductor Website: www.onsemi.com

Order Literature: <http://www.onsemi.com/orderlit>

For additional information, please contact your local Sales Representative



Компания «ЭлектроПласт» предлагает заключение долгосрочных отношений при поставках импортных электронных компонентов на взаимовыгодных условиях!

Наши преимущества:

- Оперативные поставки широкого спектра электронных компонентов отечественного и импортного производства напрямую от производителей и с крупнейших мировых складов;
- Поставка более 17-ти миллионов наименований электронных компонентов;
- Поставка сложных, дефицитных, либо снятых с производства позиций;
- Оперативные сроки поставки под заказ (от 5 рабочих дней);
- Экспресс доставка в любую точку России;
- Техническая поддержка проекта, помощь в подборе аналогов, поставка прототипов;
- Система менеджмента качества сертифицирована по Международному стандарту ISO 9001;
- Лицензия ФСБ на осуществление работ с использованием сведений, составляющих государственную тайну;
- Поставка специализированных компонентов (Xilinx, Altera, Analog Devices, Intersil, Interpoint, Microsemi, Aeroflex, Peregrine, Syfer, Eurofarad, Texas Instrument, Miteq, Cobham, E2V, MA-COM, Hittite, Mini-Circuits, General Dynamics и др.);

Помимо этого, одним из направлений компании «ЭлектроПласт» является направление «Источники питания». Мы предлагаем Вам помощь Конструкторского отдела:

- Подбор оптимального решения, техническое обоснование при выборе компонента;
- Подбор аналогов;
- Консультации по применению компонента;
- Поставка образцов и прототипов;
- Техническая поддержка проекта;
- Защита от снятия компонента с производства.



Как с нами связаться

Телефон: 8 (812) 309 58 32 (многоканальный)

Факс: 8 (812) 320-02-42

Электронная почта: org@eplast1.ru

Адрес: 198099, г. Санкт-Петербург, ул. Калинина, дом 2, корпус 4, литера А.