

# Simple Fiber Amplifier

## E3X-SD/-NA

### The Highest Level of Power and Precision in the Industry with “GIGA RAY” Giga Power Lighting Element

- Stable detection of minute objects even when the Sensor is covered with dust and oil in severe environments.
- Quick-tuning to automatically adjust light level and set threshold value.
- Use the one-key one-function feature for quick, easy operation.
- Reasonable price.



### Ordering Information

**Amplifier Units** [Refer to *Dimensions* on page 13.]  
**Digital Display and Direct Key Setting**

Item	Appearance	Connection method	Ratings and Specifications	Model	
				NPN output	PNP output
Standard models		Pre-wired (2 m)	---	E3X-SD21 2M	E3X-SD51 2M
		Wire-saving connector *		E3X-SD7	E3X-SD9

\*An Amplifier Unit Connector (sold separately) is required.

### Bar Display and Adjuster Setting



Item	Appearance	Connection method	Ratings and Specifications	Model	
				NPN output	PNP output
Standard models		Pre-wired (2 m)	---	E3X-NA11 2M	E3X-NA41 2M
		Wire-saving connector *1		E3X-NA6	E3X-NA8
High-speed detection models		Pre-wired (2 m)	Response time: 20 μs	E3X-NA11F 2M	E3X-NA41F 2M
Water-resistant models		Pre-wired (2 m)	Degree of protection: IP66	E3X-NA11V 2M	E3X-NA41V 2M
		Connector (M8) *2		E3X-NA14V	E3X-NA44V

\*1. An Amplifier Unit Connector (sold separately) is required.

\*2. A Sensor I/O Connector (sold separately) is required.

# E3X-SD/-NA



## Amplifier Unit Connectors (sold separately) Note: Protective seals provided. [Refer to Dimensions on page 17.]

Item	Appearance	Cable length	No. of conductors	Model
Master Connector		2 m	3	<b>E3X-CN11</b>
Slave Connector			1	<b>E3X-CN12</b>

Ordering Precautions for Amplifier Units Connectors <small>A Connector is not provided with the Amplifier Unit. Refer to the tables at the right when placing an order.</small>	Amplifier Units			Applicable Connectors (sold separately)		
	Type	NPN	PNP	+	Master Connector	Slave Connector
	Standard models	E3X-SD7	E3X-SD9		+	E3X-CN11 (3-wire)
E3X-NA6		E3X-NA8				
<b>When Using 5 Amplifier Units</b>						
5 Amplifier Units			+	1 Master Connector + 4 Slave Connectors		

## Sensor I/O Connectors (Models for Connectors: A Connector is not provided with the Amplifier Unit. Be sure to order a Connector separately.)

[Refer to Dimensions on XS3.]

Size	Cable specifications	Appearance	Cable type	Model	
M8	Standard cable	Straight connector 	2 m	Four-conductor cable	<b>XS3F-M421-402-A</b>
			5 m		<b>XS3F-M421-405-A</b>
		L-shaped connector 	2 m		<b>XS3F-M422-402-A</b>
			5 m		<b>XS3F-M422-405-A</b>

## Accessories (sold separately)

### Mounting Brackets

A Mounting Bracket is not provided with the Amplifier Unit. Order a Mounting Bracket separately if required.

[Refer to Dimensions on page 17.]

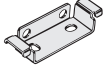
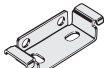
Appearance	Applicable models	Model	Quantity
	E3X-SD□ E3X-NA□ E3X-NA□F	<b>E39-L143</b>	1
	E3X-NA□V	<b>E39-L148</b>	

### End Plate

End Plates are not provided with the Amplifier Unit. Order End Plates separately if required.

[Refer to Dimensions on page 17.]

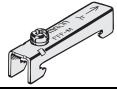
Appearance	Model	Quantity
	<b>PPF-M</b>	1

## Ratings and Specifications

### Amplifier Units

Type	Digital display and direct key setting		Bar display and adjuster setting		
	Standard models		Standard models	High-speed detection models	Water-resistant models
Item	Model	E3X-SD□	E3X-NA□	E3X-NA□F	E3X-NA□V
Light source (wavelength)	Red, 4-element LED (625 nm)				Red LED (680 nm)
Power supply voltage	12 to 24 VDC ±10%, ripple (p-p): 10% max.				
Power consumption/ Current consumption	960 mW max. (Power supply voltage: 24 V, Current consumption: 40 mA max.) (Power supply voltage: 12 V, Current consumption: 80 mA max.)		960 mW max. (Current consumption: 40 mA max.)		
Control output	Open-collector output (NPN or PNP) Load power supply: 26.4 V max., Load current: 50 mA max. (Residual voltage: 1.5 V max.) Light-ON/Dark-ON mode selector		Open-collector output (NPN or PNP) Load power supply: 26.4 V max., Load current: 50 mA max. (Residual voltage: 1 V max.) Light-ON/Dark-ON mode selector.		
Response time	Operate or reset: 200 μs max. (*1)			Operate: 20 μs max. Reset: 30 μs max.	Operate or reset: 200 μs max. (*1)
Sensitivity adjustment	UP/DOWN direct key setting, teaching with/without a workpiece, automatic teaching		8-turn sensitivity adjuster (with indicator)		
Protection circuits	Power supply reverse polarity protection, output short-circuit protection, output reverse polarity protection		Power supply reverse polarity protection, output short-circuit protection		
Timer function	---		No timer, OFF-delay timer; or Timer selector (timer time: 40 ms (fixed))		
Mutual interference prevention	Up to 5 Amplifiers (optically synchronized) (*2)			None	Up to 5 Amplifiers (optical- ly synchronized) (*2)
Ambient illumination	Receiver side Incandescent lamp: 10,000 lux max. Sunlight: 20,000 lux max.				
Number of gang-mounted Amplifiers	16 max. (The ambient temperature specification depends on the number of gang-mounted Amplifiers.)				
Ambient temperature range	Operating: Groups of 1 to 3 Amplifiers: -25°C to 55°C Groups of 4 to 11 Amplifiers: -25°C to 50°C Groups of 12 to 16 Amplifiers: -25°C to 45°C Storage: -30°C to 70°C (with no icing or condensation)				
Ambient humidity range	Operating and storage: 35% to 85% (with no condensation)				
Insulation resistance	20 MΩ min. (at 500 VDC)				
Dielectric strength	1,000 VAC at 50/60 Hz for 1 minute (*3)				
Vibration resistance	Destruction: 10 to 55 Hz with a 1.5-mm double amplitude for 2 hours each in X, Y and Z directions				
Shock resistance	Destruction: 500 m/s <sup>2</sup> , for 3 times each in X, Y and Z directions				
Degree of protection	IEC 60529 IP50 (with Protective Cover attached)				IEC 60529 IP66 (with Protective Cover at- tached)
Connection method	Pre-wired (standard cable length: 2 m), or connector				
Weight (packed state) (*4)	Pre-wired model: Approx. 100 g, Model with connector: Approx. 55 g				
Material	Case	Polybutylene terephthalate (PBT)			
	Cover	Polycarbonate (PC)			Polyethersulfone (PES)
Accessories	Instruction manual				

\*1. When there are 8 or more E3X-NA Amplifiers mounted side-by-side, the response time will be 350 μs max.

\*2. Mutual interference prevention is effective when E3X-SD/-NA-series Amplifiers are gang-mounted without other E3X-series Amplifiers.

\*3. Water-resistant models and models with connectors have a dielectric strength of 500 VAC.

\*4. Add 10 g for water-resistant models.

### Amplifier Unit Connectors (Wire-saving Connectors)

Item	Model	E3X-CN11	E3X-CN12
Rated current	2.5 A		
Rated voltage	50 V		
Contact resistance	20 mΩ max. (20 mVDC max., 100 mA max.) (The above figure is for connection to the Amplifier Unit and the adjacent Connector. It does not include the conductor resistance of the cable.)		
Number of insertions	Destruction: 50 times (for connection to the Amplifier Unit and the adjacent Connector)		
Material	Housing	Polybutylene terephthalate (PBT)	
	Contact	Phosphor bronze/gold-plated nickel	
Weight (packed state)	Approx. 55 g		Approx. 25 g

# E3X-SD/-NA

## Sensing distance

Fiber Unit				Amplifier Unit	Sensing distance (Unit: mm)		
Screw-shaped model				E3X-SD□ E3X-NA□	E3X-NA□F	E3X-NA□V	
Sensing method	Size	Sensing direction	Model	Standard models	High-speed detection models	Water-resistance models	
Through-beam models	M3	Straight	E32-T21R 2M	120	36	60	
	M4	Right angle	E32-T11N 2M	530	160	280	
		Straight	E32-T11R 2M	560	160	280	
			E32-TC200 2M	800	240	400	
			E32-T11L 2M	1,400	420	700	
Reflective models	M3	Right angle	E32-C31N 2M	25	7.5	13	
		Straight	E32-D21R 2M	30	10	15	
			E32-C31 2M	80	26	40	
			E32-D21R 2M	30	10	15	
	M4	Right angle	E32-D11N 2M	170	50	90	
			E32-C11N 2M	170	50	85	
	M6	Straight	E32-D11R 2M	180	60	90	
			E32-DC200 2M	300	100	150	
			E32-CC200 2M	300	100	150	
			E32-D11L 2M	400	130	200	

Fiber Unit				Amplifier Unit	Sensing distance (Unit: mm)		
Flat model				E3X-SD□ E3X-NA□	E3X-NA□F	E3X-NA□V	
Sensing method	Sensing direction	Size	Model	Standard models	High-speed detection models	Water-resistance models	
Through-beam models	Top view	Standard	E32-T15XR 2M	560	160	280	
		Small	E32-T25XR 2M	120	36	60	
	Side view	Standard	E32-T15YR 2M	220	66	110	
		Small	E32-T25YR 2M	60	18	30	
	Flat view	Standard	E32-T15ZR 2M	220	66	110	
		Small	E32-T25ZR 2M	60	18	30	
Reflective models	Top view	Standard	E32-D15XR 2M	180	60	90	
		Small	E32-D25XR 2M	30	10	15	
	Side view	Standard	E32-D15YR 2M	40	10	20	
		Small	E32-D25YR 2M	8	2.4	4	
	Flat view	Standard	E32-D15ZR 2M	40	10	20	
		Small	E32-D25ZR 2M	8	2.4	4	

Fiber Unit				Amplifier Unit	Sensing distance (Unit: mm)		
Cylindrical model				E3X-SD□ E3X-NA□	E3X-NA□F	E3X-NA□V	
Sensing method	Sensing direction	Size	Model	Standard models	High-speed detection models	Water-resistance models	
Through-beam models	Top view	φ1	E32-T223R 2M	120	36	60	
		φ3	E32-T12R 2M	560	160	280	
	Side view	φ1	E32-T24R 2M	60	18	30	
		φ3	E32-T14LR 2M	220	66	110	
Reflective models	Top view	φ1.5	E32-D22B 2M	30	10	15	
		φ2	E32-D32 2M	80	26	40	
		φ3	E32-D22R 2M	30	10	15	
			E32-D32L 2M	160	50	80	
	Side view	φ2	E32-D24R 2M	14	4.6	7	
		φ6	E32-D14LR 2M	32	10	16	

For information on Fiber Units, refer to the *Fiber Sensors Best Selection Catalog* (Cat. No. E353).

Fiber Unit				Amplifier Unit	Sensing distance (Unit: mm)		
Model equipped with sleeve				E3X-SD□ E3X-NA□	E3X-NA□F	E3X-NA□V	
Sensing method	Sleeve size	Mounting size	Model	Standard models	High-speed detection models	Water-resistance models	
Through-beam models	φ0.25 × 5	φ3	E32-T333-S5 1M	10	3	5	
	φ0.5 × 40		E32-T33 1M	40	13.5	20	
	φ0.9 × 40	M3	E32-TC200F4R 2M	120	36	60	
	φ1.2 × 90	M4	E32-TC200BR 2M	560	160	280	
Reflective models	φ0.5 × 15	φ2	E32-D331 2M	3	1	1.5	
	φ0.8 × 15	φ3	E32-D33 2M	16	4	10	
	φ1.2 × 40	M3	E32-DC200F4R 2M	30	10	15	
	φ2.5 × 90	M6	E32-DC200BR 2M	180	60	90	

Fiber Unit				Amplifier Unit	Sensing distance (Unit: mm)		
Movable section (Flexibility)				E3X-SD□ E3X-NA□	E3X-NA□F	E3X-NA□V	
Sensing method	Shape	Size	Model	Standard models	High-speed detection models	Water-resistance models	
Through-beam models	Screw-shaped model	M3	E32-T21 2M	200	60	100	
		M4	E32-T11 2M	720	200	360	
	Cylindrical model	φ1.5	E32-T22B 2M	200	60	100	
		φ3	E32-T12B 2M	720	200	360	
	Flat model	Standard	E32-T15XB 2M	720	200	360	
Small		E32-T25XB 2M	150	40	75		
Reflective models	Screw-shaped model	M3	E32-D21 2M	30	10	15	
		M4	E32-D21B 2M	70	20	35	
		M6	E32-D11 2M	180	60	90	
	Cylindrical model	φ1.5	E32-D22B 2M	30	10	15	
		φ3	E32-D221B 2M	70	20	35	
	Flat model	Standard	E32-D15XB 2M	180	60	90	
		Small	E32-D25XB 2M	50	16	25	

Fiber Unit				Amplifier Unit	Sensing distance (Unit: mm)		
Heat-resistance model				E3X-SD□ E3X-NA□	E3X-NA□F	E3X-NA□V	
Sensing method	Operating temperature	Lens	Model	Standard models	High-speed detection models	Water-resistance models	
Through-beam models	100°C	---	E32-T51R 2M	400	120	225	
		Lens	E32-T51R 2M + E39-F1	2,000	720	1,650	
		High-power lens	E32-T51R 2M + E39-F16	4,000 *	1,560	2,900	
	150°C	---	E32-T51 2M	800	240	400	
		Lens	E32-T51 2M + E39-F1-33	2,400	720	1,400	
		High-power lens	E32-T51 2M + E39-F16	4,000 *	3,120	4,000 *	
	200°C	---	E32-T54 2M	260	70	130	
		Lens	E32-T81R-S 2M	360	100	180	
		Lens	E32-T61-S 2M + E39-F1	4,000 *	1,800	3,000	
	350°C	---	E32-T61-S 2M	600	180	300	
High-power lens		E32-T61-S 2M + E39-F16	4,000 *	2,340	3,900		
Reflective models	100°C	---	E32-D51R 2M	140	42	70	
	150°C		E32-D51 2M	240	80	120	
	200°C		E32-D81R 2M	90	27	45	
	350°C		E32-D61 2M	90	27	45	
	400°C		E32-D73 2M	60	18	30	

\* The fiber length is 2 m on each side, so the sensing distance is given as 4,000 mm.

For information on Fiber Units, refer to the *Fiber Sensors Best Selection Catalog* (Cat. No. E353).

# E3X-SD/-NA

Fiber Unit			Amplifier Unit	Sensing distance (Unit: mm)		
				E3X-SD□ E3X-NA□	E3X-NA□F	E3X-NA□V
Chemical-resistance / Oil-resistance model						
Sensing method	Type	Model	Standard models	High-speed detection models	Water-resistance models	
Through-beam models	φ5	E32-T12F 2M	3,200	960	1,600	
	φ7.2	E32-T11F 2M	2,100	760	1,050	
	φ5 Heat-resistance	E32-T51F 2M	1,400	400	700	
	φ5 Side view	E32-T14F 2M	400	120	200	
	M4 Chemical-resistance cable	E32-T11U 2M	720	200	360	
	M4 Right angle Chemical-resistance cable	E32-T11NU 2M	400	120	210	
Reflective models	φ6	E32-D12F 2M	100	32	50	
	φ7 Side view	E32-D14F 2M	40	13	20	
	M6 Chemical-resistance cable	E32-D11U 2M	180	60	90	

Fiber Unit			Amplifier Unit	Sensing distance (Unit: mm)		
				E3X-SD□ E3X-NA□	E3X-NA□F	E3X-NA□V
Vacuum-resistance model						
Sensing method	Operating ambient temperature	Sensing direction	Model	Standard models	High-speed detection models	Water-resistance models
Through-beam models	120°C	Top view	E32-T51V 1M	200	---	100
			E32-T51V 1M + E39-F1V	1,200	---	600
	200°C	Right angle	E32-T54V 1M	130	---	65
			E32-T84SV 1M	500	---	250

For information on Fiber Units, refer to the *Fiber Sensors Best Selection Catalog* (Cat. No. E353).

Fiber Unit			Amplifier Unit	Sensing distance (Unit: mm)		
Long distance/Dust resistance (High-power), Detection through gaps (Narrow vision field)				E3X-SD□ E3X-NA□	E3X-NA□F	E3X-NA□V
Sensing method	Type	Sensing direction/ Lens type	Model	Standard models	High-speed detection models	Water-resistance models
Through-beam models	High-power (integrated unit)	Top view	E32-T17L 10M	20,000 *1	8,400	14,000
		Side view	E32-T14 2M	3,600	1,080	1,800
	High-power (with lens unit)	High-power	E32-T11N 2M + E39-F1	3,700	1,110	2,100
		Ultrahigh-power	E32-T11N 2M + E39-F16	4,000 *2	2,000	3,600
		High-power	E32-T11R 2M + E39-F1	4,000 *2	1,260	2,100
		Ultrahigh-power	E32-T11R 2M + E39-F16	4,000 *2	2,000	3,600
		Side view	E32-T11R 2M + E39-F2	440	130	220
		High-power	E32-TC200 2M + E39-F1	4,000 *2	1,800	3,000
		Ultrahigh-power	E32-TC200 2M + E39-F16	4,000 *2	3,000	4,000 *2
		Side view	E32-TC200 2M + E39-F2	700	210	350
		High-power	E32-T11 2M + E39-F1	4,000 *2	1,200	2,000
		Ultrahigh-power	E32-T11 2M + E39-F16	4,000 *2	2,600	4,000 *2
		Side view	E32-T11 2M + E39-F2	720	200	360
		High-power	E32-T11U 2M + E39-F1	3,600	1,080	2,000
		Ultrahigh-power	E32-T11U 2M + E39-F16	4,000 *2	2,600	4,000 *2
		Side view	E32-T11U 2M + E39-F2	660	198	330
		High-power	E32-T11NU 2M + E39-F1	1,800	700	1,500
		Ultrahigh-power	E32-T11NU 2M + E39-F16	4,000 *2	1,500	2,700
		High-power	E32-T81R-S 2M + E39-F1	1,800	630	1,100
		Ultrahigh-power	E32-T81R-S 2M + E39-F16	4,000 *2	1,300	2,300
		Side view	E32-T81R-S 2M + E39-F2	280	84	140
	High-power	E32-T61-S 2M + E39-F1	4,000 *2	1,800	3,000	
	Ultrahigh-power	E32-T61-S 2M + E39-F16	4,000 *2	2,340	3,900	
Side view	E32-T61-S 2M + E39-F2	780	260	390		
Narrow vision field (aperture angle: 4°)	Top view	E32-T22S 2M	2,000	600	1,000	
	Side view	E32-T24S 2M	1,400	420	700	
Reflective models	High-power	Top view	E32-D16 2M	800	140	40 to 400

\*1. The fiber length is 10 m on each side, so the sensing distance is given as 20,000 mm.

\*2. The fiber length is 2 m on each side, so the sensing distance is given as 4,000 mm.

Fiber Unit			Amplifier Unit	Sensing distance (Unit: mm)		
Minute object detection (Small-spot model)				E3X-SD□ E3X-NA□	E3X-NA□F	E3X-NA□V
Sensing method	Spot diameter (mm)	Focal length (mm)	Model	Standard models	High-speed detection models	Water-resistance models
Reflective models	φ0.1 to 0.6 (Variable)	6 to 15	E32-C42 1M + E39-F3A	Spot diameter of 0.1 to 0.6 mm at 6 to 15 mm		
	φ0.1	5	E32-C42S 1M	Spot diameter of 0.1 mm at 5 mm		
		7	E32-C41 1M + E39-F3A-5	Spot diameter of 0.1 mm at 7 mm		
	φ0.2	17	E32-C41 1M + E39-F3B	Spot diameter of 0.2 mm at 17 mm		
	φ0.5	7	E32-C31 2M + E39-F3A-5	Spot diameter of 0.5 mm at 7 mm		
		17	E32-C31 2M + E39-F3B	Spot diameter of 0.5 mm at 17 mm		
	φ6	50	E32-L15 2M	Spot diameter of 6 mm at 50 mm		
	φ4 Parallel light	0 to 20	E32-C31 2M + E39-F3C	Spot diameter of 4 mm max. at 0 to 20 mm		
φ3	50	E32-C11N 2M + E39-F18	Spot diameter of 3 mm at 50 mm			
		E32-CC200 2M + E39-F18	Spot diameter of 3 mm at 50 mm			

For information on Fiber Units, refer to the *Fiber Sensors Best Selection Catalog* (Cat. No. E353).

# E3X-SD/-NA

Fiber Unit				Amplifier Unit	Sensing distance (Unit: mm)		
Area-sensing (Area beam)				E3X-SD□ E3X-NA□	E3X-NA□F	E3X-NA□V	
Sensing method	Area range	Sensing direction	Model	Standard models	High-speed detection models	Water-resistance models	
Through-beam models	11 mm	Side view	E32-T16PR 2M	800	260	450	
		Flat view	E32-T16JR 2M	700	220	390	
Reflective models	30 mm	Side view	E32-T16WR 2M	1,380	400	690	
	11 mm		E32-D36P1 2M	150	50	75	

Fiber Unit				Amplifier Unit	Sensing distance (Unit: mm)		
Detection without background interference (Convergent-reflective)				E3X-SD□ E3X-NA□	E3X-NA□F	E3X-NA□V	
Sensing method	Sensing detection	Size	Model	Standard models	High-speed detection models	Water-resistance models	
Reflective models	Flat view	Standard	E32-L16-N 2M	0 to 15	0 to 12	0 to 15	
		Small	E32-L24S 2M	0 to 4			
	Top view	---	E32-L25L 2M	5.4 to 9 (Center 7.2)	5.4 to 8 (Center 7.2)	5.4 to 9 (Center 7.2)	
	Flat view		E32-L24L 2M	2 to 6 (Center 4)			

Fiber Unit				Amplifier Unit	Sensing distance (Unit: mm)		
Detection of transparent objects (Retro-reflective)				E3X-SD□ E3X-NA□	E3X-NA□F	E3X-NA□V	
Sensing method	Type	Model		Standard models	High-speed detection models	Water-resistance models	
Retro-reflective models *1	Square	E32-R16 5M + E39-R1 (Attached)		1,500	1,000	150 to 1,500	
	Small	E32-R21 2M + E39-R3 (Attached)		10 to 250	250	10 to 250	
	Film detection *2	E32-C31 2M + E39-F3R + E39-RP1		450	135	225	
		E32-C31 2M + E39-F3R + E39-RSP1		220	65	110	

\*1. When using a highly reflective object, light reflected from the object may affect the Sensor.  
 \*2. Film detection may not be effective for some types of film. Confirm operation in advance.

**For information on Fiber Units, refer to the *Fiber Sensors Best Selection Catalog* (Cat. No. E353).**



Fiber Unit				Amplifier Unit	Sensing distance (Unit: mm)				
FPD / Semiconductor / Solar battery industry				E3X-SD□ E3X-NA□	E3X-NA□F	E3X-NA□V			
Sensing method	Application	Operating temperature	Model	Standard models	High-speed detection models	Water-resistance models			
Reflective models	Glass substrate alignment	70°C	E32-L16-N 2M	0 to 15					
			E32-A08 2M	10 to 20					
	Glass detection	300°C	E32-A08H2 3M	10 to 20					
			E32-L16-N 2M	0 to 15					
	Glass substrate mapping	70°C	E32-A09 2M	15 to 38 (Center 25)					
			150°C	E32-A09H 2M	15 to 38 (Center 25)				
				E32-A09H2 2M	20 to 30 (Center 25)				
	WET process	60°C	E32-L11FP 5M	8 to 20 mm from end of lens (recommended: 11 mm) 19 to 31 mm from center point A of mounting hole (recommended: 22 mm)					
				70°C	E32-L12FS 5M	8 to 20 mm from end of lens (recommended: 11 mm) 32 to 44 mm from center point A of mounting hole (recommended: 35 mm)			
						85°C	E32-L11FS 5M	8 to 20 mm from end of lens (recommended: 11 mm) 32 to 44 mm from center point A of mounting hole (recommended: 35 mm)	
Through-beam models	Wafer mapping	70°C	E32-A03 2M	890	267	445			
			E32-A03-1 2M	890	267	445			
			E32-A04 2M	340	102	170			
			E32-A04-1 2M	340	102	170			

Fiber Unit				Amplifier Unit	Sensing distance (Unit: mm)		
Liquid-level detection model				E3X-SD□ E3X-NA□	E3X-NA□F	E3X-NA□V	
Sensing method	Sensing direction	Pipe diameter	Model	Standard models	High-speed detection models	Water-resistance models	
Reflective models	Mounted to pipe	No limit	E32-D36T 5M	Applicable pipe: Transparent (no restriction on diameter)			
		φ8 to 10 mm	E32-L25T 2M	Applicable pipe: Transparent pipe with diameter of 8 to 10 mm, recommended pipe wall thickness: 1 mm			
	Wet	---	E32-D82F1 4M	Wet model			

For information on Fiber Units, refer to the *Fiber Sensors Best Selection Catalog* (Cat. No. E353).

# E3X-SD/-NA

## I/O Circuit Diagrams

Output form	Model	Output transistor operation mode	Timing charts	Operation selector	Output circuit
NPN Output	E3X-SD21 E3X-SD7  E3X-NA11 E3X-NA6 E3X-NA11F E3X-NA11V E3X-NA14V	Light-ON		LIGHT ON (L-ON)	<p>• M8 Connector Pin Arrangement </p>
		Dark-ON		DARK ON (D-ON)	
PNP Output	E3X-SD51 E3X-SD9  E3X-NA41 E3X-NA8 E3X-NA41F E3X-NA41V E3X-NA44V	Light-ON		LIGHT ON (L-ON)	<p>• M8 Connector Pin Arrangement </p>
		Dark-ON		DARK ON (D-ON)	

Note: Timing Charts for Timer Settings (T: Set Time)

### OFF delay



### Plug (Sensor I/O Connector)

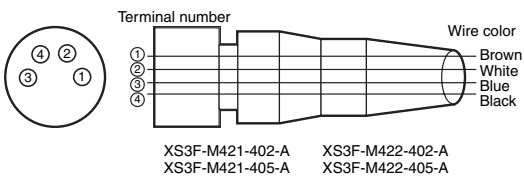

Classification	Wire color	Connection pin	Application
DC	Brown	1	Power supply (+V)
	White	2	---
	Blue	3	Power supply (0 V)
	Black	4	Output

Note: Pin 2 is not used.

## Safety Precautions

### ⚠ WARNING

This product is not designed or rated for ensuring safety of persons either directly or indirectly.

Do not use it for such purposes.



### ⚠ Caution

Do not exceed the rated voltage. Excess voltage may result in malfunction or fire.



Do not use an AC power supply. Using an AC power supply may result in rupturing.



High-temperature environments may result in burn injury.



### Precautions for Safe Use

The following precautions must be observed to ensure safety.

1. Do not use the product in locations where flammable or explosive gas is present.
2. Do not use the product in locations subject to splashing water, oil, or chemicals, or in locations subject to steam.
3. Do not attempt to disassemble, repair, or modify the product.
4. Do not apply voltage or current in excess of the rated ranges.
5. Do not use the product in atmospheres or environments that exceed product ratings.
6. Do not wire the product incorrectly, such as using incorrect power supply polarity.
7. Connect the load properly.
8. Do not short-circuit both ends of the load.
9. Do not use the product if the case is damaged.
10. When disposing of the product, dispose of it as industrial waste.
11. Do not use the product in locations subject to direct sunlight.
12. The surface temperature of the product may rise as a result of the ambient temperature, power supply, or other usage conditions. Use caution when performing maintenance and washing. Failure to do so may result in burn injury.

### Precautions for Correct Use

Do not use the product in atmospheres or environments that exceed product ratings.

#### Amplifier Units

##### ● Designing

##### Communications Hole

The hole on the side of the Amplifier Unit is a communications hole for preventing mutual interference when Amplifier Units are mounted side-by-side. The E3X-MC11 Mobile Console (sold separately) cannot be used.

If an excessive amount of light is received via the Sensor, the mutual interference prevention function may not work. In this case, make the appropriate adjustments using the sensitivity adjuster.

Mutual interference prevention is effective when E3X-SD/-NA-series Amplifiers are gang-mounted without other E3X-series Amplifiers.

##### ● Mounting

##### DIN Track Mounting/Removal

##### Mounting Amplifier Units

1. Mount the Amplifier Units one at a time onto the DIN track.

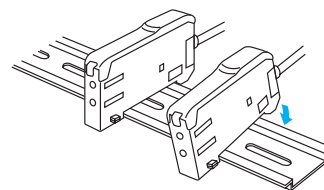

2. Slide the Amplifier Units together, line up the clips, and press the Amplifier Units together until they click into place.

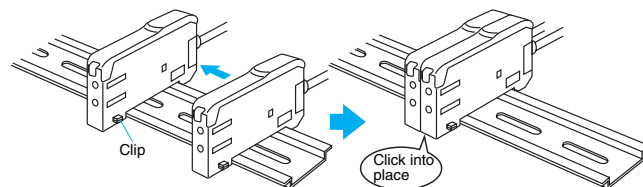

##### Removing Amplifier Units

Slide Amplifier Units away from each other, and remove from the DIN track one at a time. (Do not attempt to remove Amplifier Units from the DIN track without separating them first.)

- Note 1.** The specifications for ambient temperature will vary according to the number of Amplifier Units used together. For details, refer to *Ratings and Specifications*.
- 2.** Always turn OFF the power supply before mounting or removing Amplifier Units.

## Fiber Connection and Disconnection

The E3X Amplifier Unit has a lock lever. Connect or disconnect the fibers to or from the E3X Amplifier Unit using the following procedures:

### 1. Connection

Open the Protective Cover, insert the fibers according to the fiber insertion marks on the side of the Amplifier Unit, and lower the lock lever.

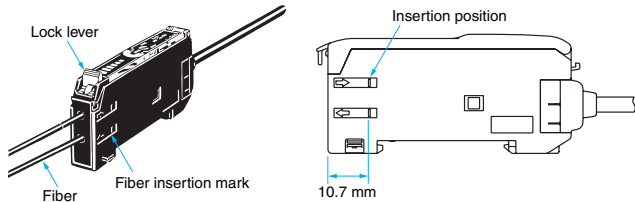

**Note:** If one of the fibers from the Fiber Unit has a white line, such as with a Coaxial Sensor, that fiber is for the Emitter. Insert it into the Emitter section. Refer to Dimensions for the Fiber Unit to see if there is an Emitter fiber.

### 2. Disconnection

Remove the Protective Cover and raise the lock lever to pull out the fiber.

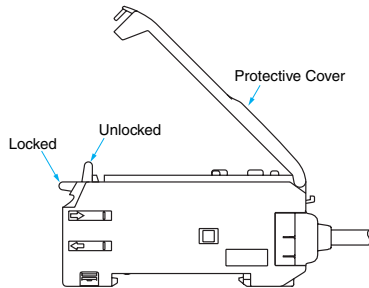

**Note:** To maintain the fiber properties, confirm that the lock is released before removing the fiber.

### 3. Precautions for Fiber Connection/Disconnection

Be sure to lock or unlock the lock lever within an ambient temperature range between  $-10^{\circ}\text{C}$  and  $40^{\circ}\text{C}$ .

#### ● Operating Environment

##### Ambient Conditions

If dust or dirt adhere to the hole for optical communications, it may prevent normal communications. Be sure to remove any dust or dirt before using the Units.

#### ● Other

##### Protective Cover

Be sure to mount the Protective Cover before use.

## Amplifier Units with Connectors

#### ● Mounting

##### Mounting Connectors

1. Insert the Master or Slave Connector into the Amplifier Unit until it clicks into place.

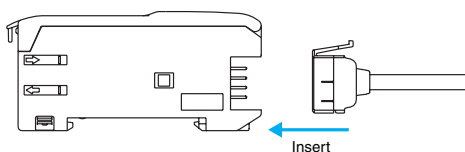

2. Join Amplifier Units together as required after all the Master and Slave Connectors have been inserted.

3. Attach the stickers (provided as accessories) to the sides of Master and Slave Connectors that are not connected to other Connectors.

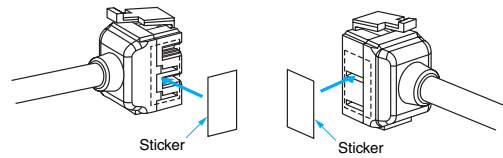

**Note:** Attach the stickers to the sides with grooves.

### Removing Connectors

1. Slide the slave Amplifier Unit for which the Connector is to be removed away from the rest of the group.
2. After the Amplifier Unit has been separated, press down on the lever on the Connector and remove it. (Do not attempt to remove Connectors without separating them from other Amplifier Units first.)

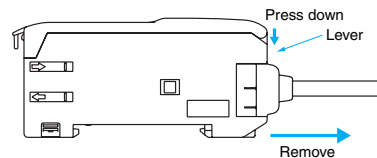

### Mounting End Plate (PFP-M)

Depending on how it is mounted, an Amplifier Unit may move during operation. In this case, use an End Plate.

Before mounting an End Plate, remove the clip from the master Amplifier Unit using a nipper or similar tool.

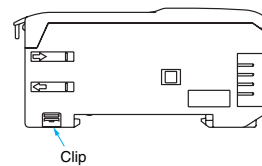

The clip can also be removed using the following mechanism, which is incorporated in the construction of the section underneath the clip.

1. Insert the clip to be removed into the slit underneath the clip on another Amplifier Unit.

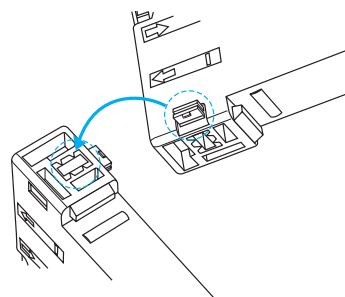

2. Remove the clip by rotating the Amplifier Unit.

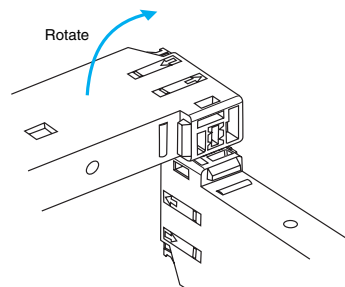

### Pull Strengths for Connectors (Including Cables)

E3X-CN11: 30 N max.

E3X-CN12: 12 N max.

## Dimensions

### Amplifier Units

#### Amplifier Units with Cables

- E3X-SD21
- E3X-SD51
- E3X-NA11
- E3X-NA11F
- E3X-NA41
- E3X-NA41F

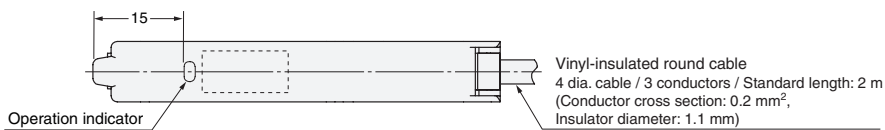
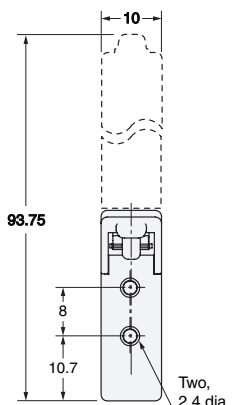

#### DIN track mounting

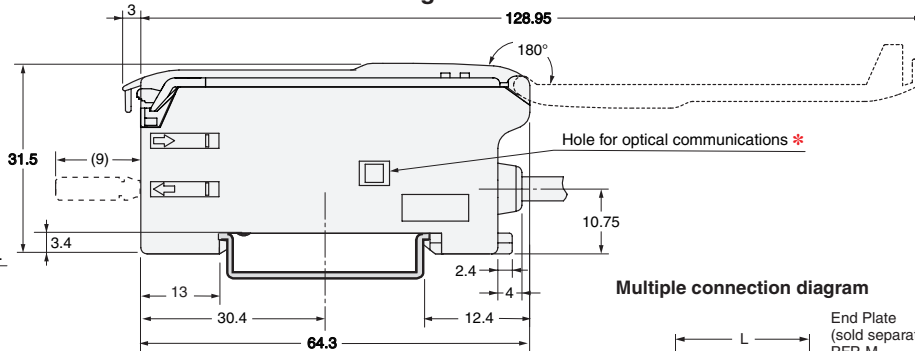

#### Multiple connection diagram

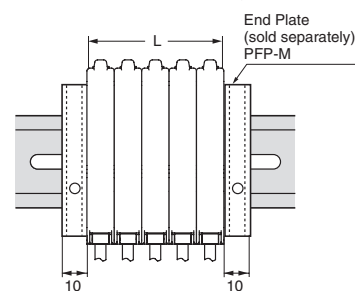

The number of expansion	L (mm)
1	10
2	20
3	30
4	40
5	50
6	60
7	70
8	80
9	90
10	100

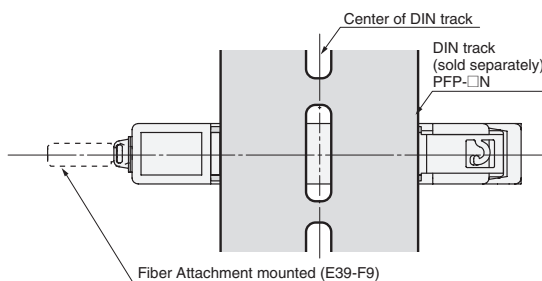

#### With Mounting Bracket Attached

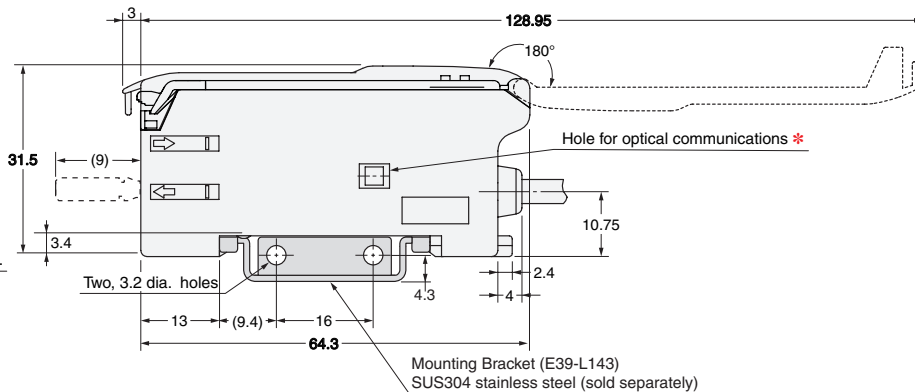
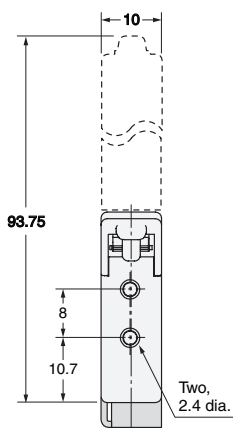

#### Mounting Holes

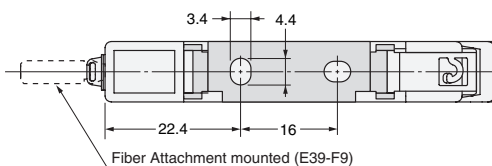
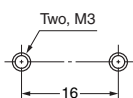

\* There is no hole for E3X-NA□F models.

**Note:** When using E39-L143 Mounting Brackets, there will be small gaps between the Amplifier Units if they are mounted side by side.

# E3X-SD/-NA

## Amplifier Units with Connectors

E3X-SD7  
E3X-SD9  
E3X-NA6  
E3X-NA8

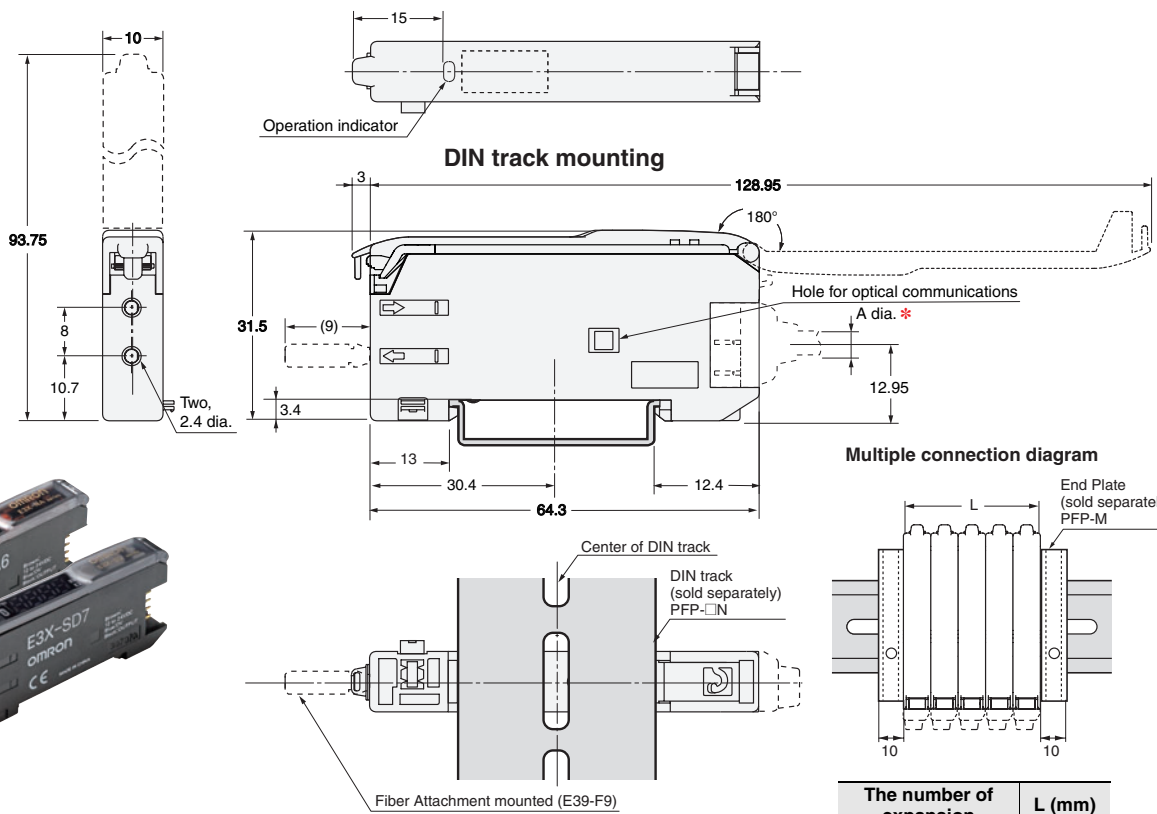

Multiple connection diagram

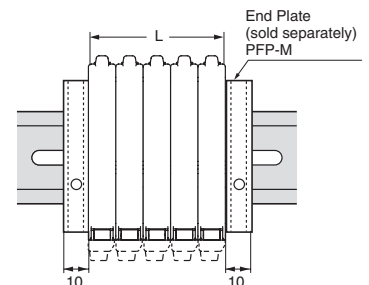

The number of expansion	L (mm)
1	10
2	20
3	30
4	40
5	50
6	60
7	70
8	80
9	90
10	100

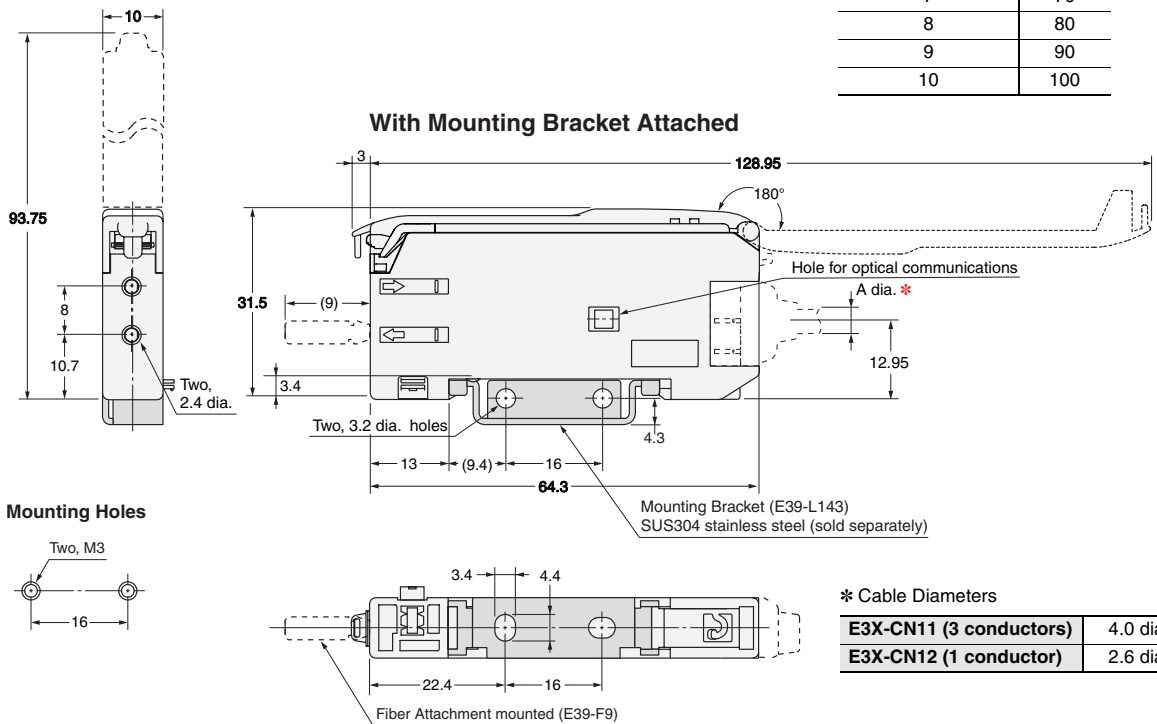

Mounting Holes

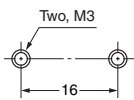

\* Cable Diameters

E3X-CN11 (3 conductors)	4.0 dia.
E3X-CN12 (1 conductor)	2.6 dia.

**Note:** When using E39-L143 Mounting Brackets, there will be small gaps between the Amplifier Units if they are mounted side by side.

## Amplifier Units with Cables, Water-resistant Models E3X-NA11V E3X-NA41V

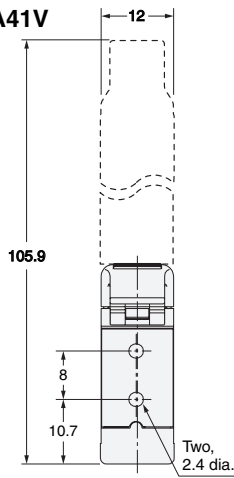

### Area of digital indication

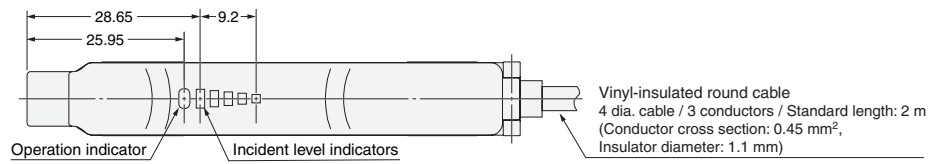

### DIN track mounting

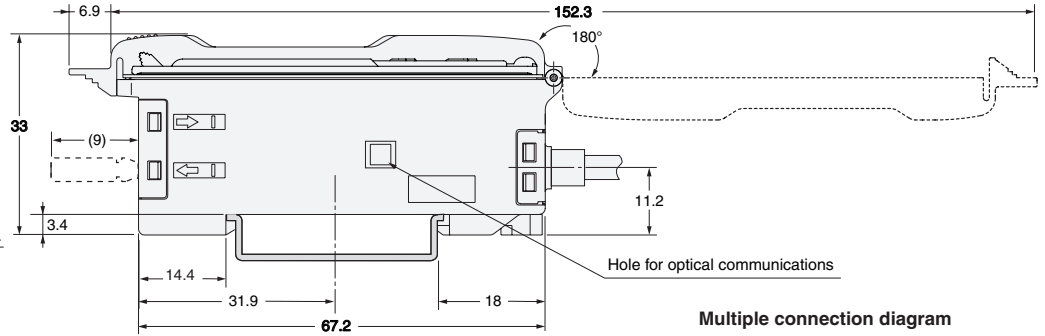

### Multiple connection diagram

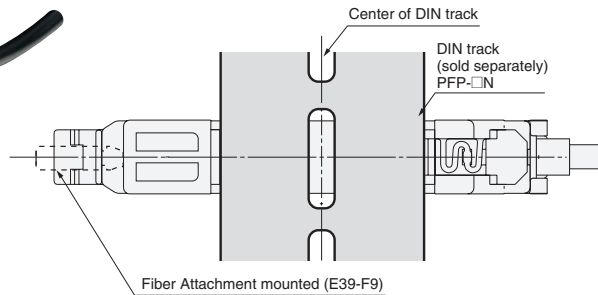
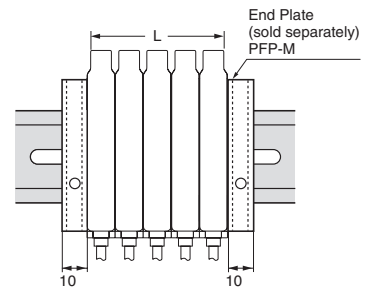

The number of expansion	L (mm)
1	12
2	24
3	36
4	48
5	60
6	72
7	84
8	96
9	108
10	120

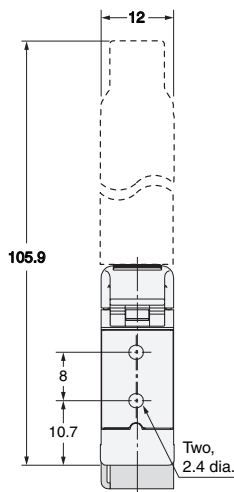

### With Mounting Bracket Attached

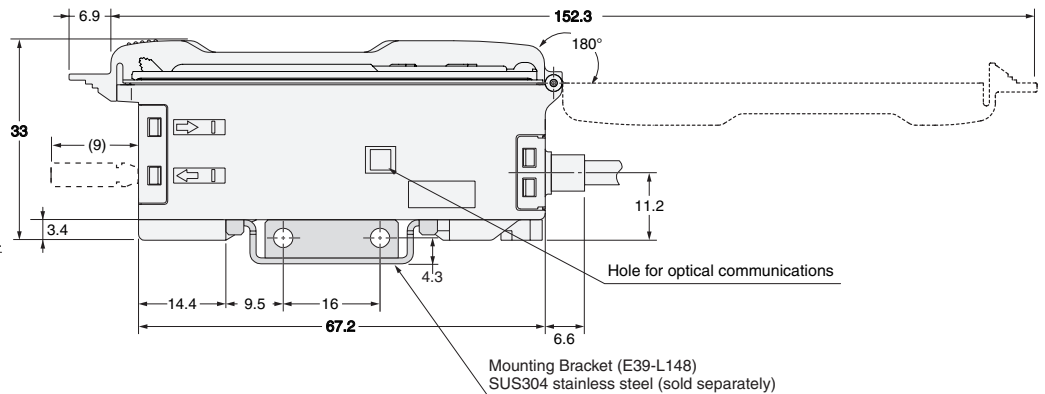

### Mounting Holes

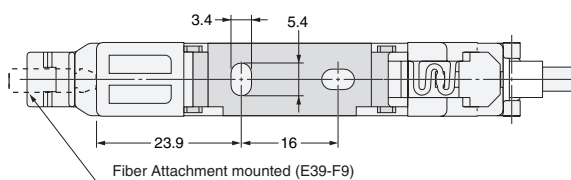
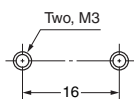

# E3X-SD/-NA

## Amplifier Units with Connectors, Water-resistant Models

E3X-NA14V  
E3X-NA44V

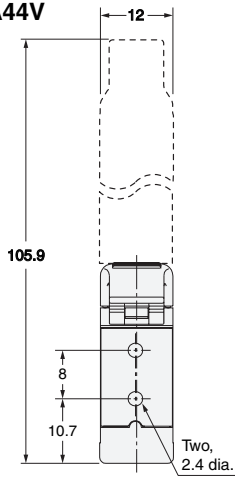

### Area of digital indication

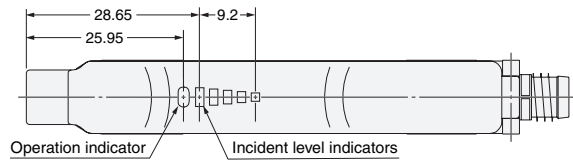

### DIN track mounting

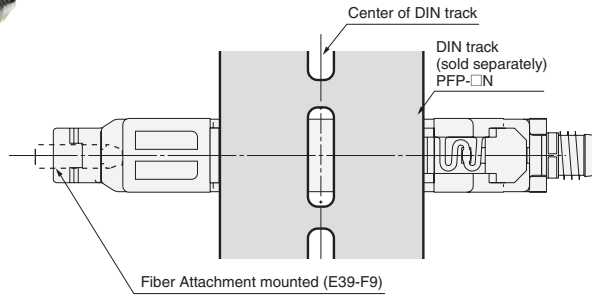
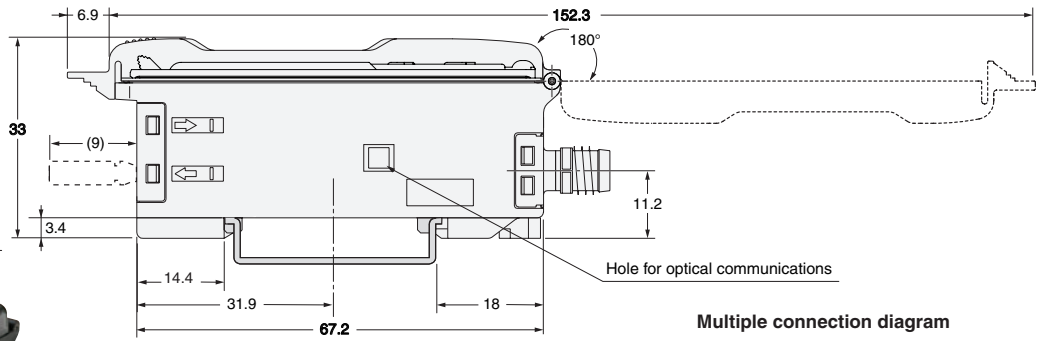

### Multiple connection diagram

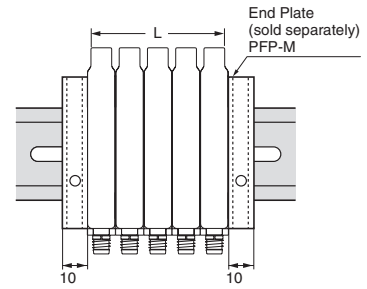

The number of expansion	L (mm)
1	12
2	24
3	36
4	48
5	60
6	72
7	84
8	96
9	108
10	120

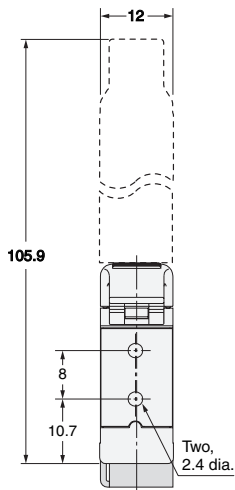

### With Mounting Bracket Attached

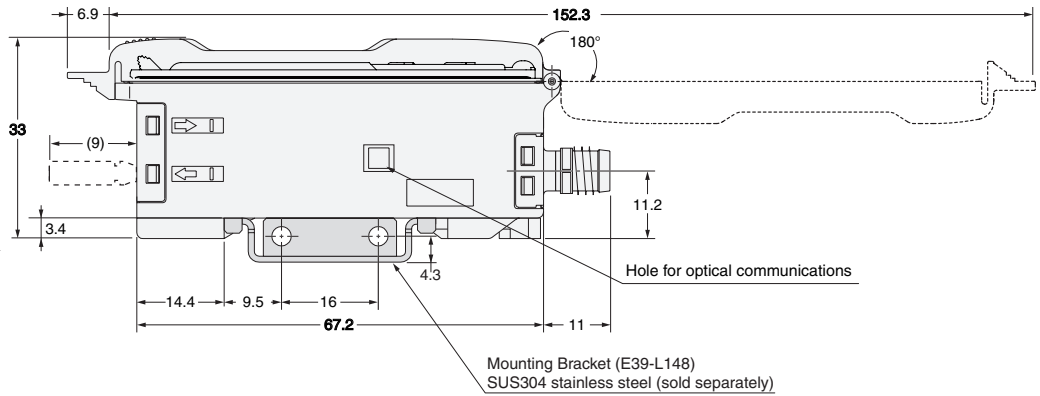

### Mounting Holes

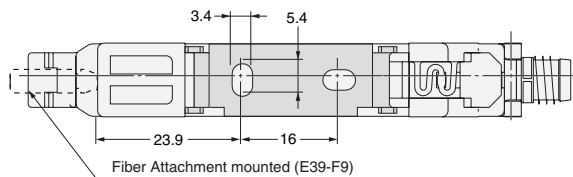
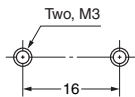



## Amplifier Unit Connectors (Wire-saving Connectors)

### Master Connector E3X-CN11

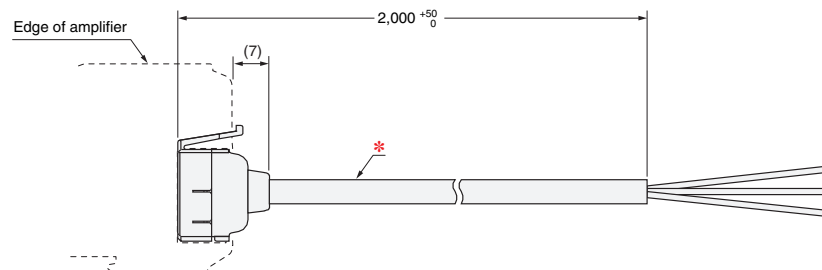

\* E3X-CN11: **4 dia. cable / 3 conductors** / Standard length: 2 m (Conductor cross section: 0.2 mm<sup>2</sup> (AWG24), Insulator diameter: 1.1 mm)

### Slave Connector E3X-CN12

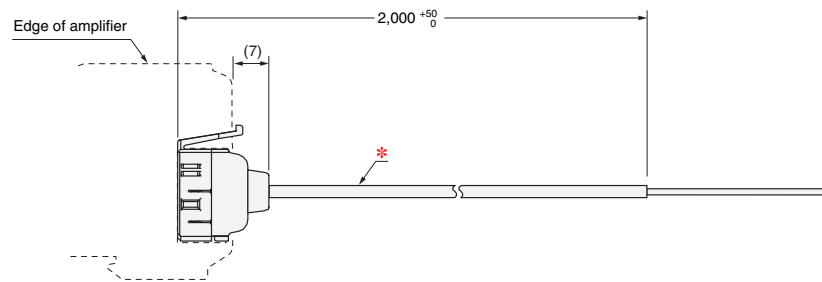

\* E3X-CN12: **2.6 dia. cable / 1 conductor** / Standard length: 2 m (Conductor cross section: 0.2 mm<sup>2</sup> (AWG24), Insulator diameter: 1.1 mm)

## Accessories (sold separately)

### Mounting Brackets E39-L143

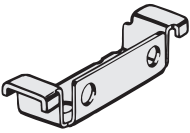

Material: Stainless steel (SUS304)

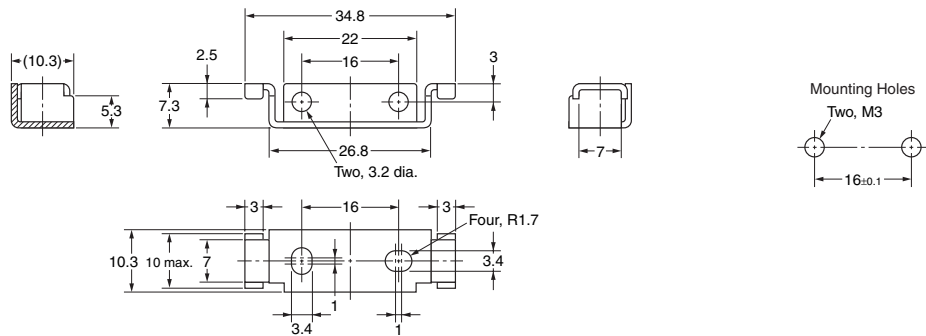

### End Plates PFP-M

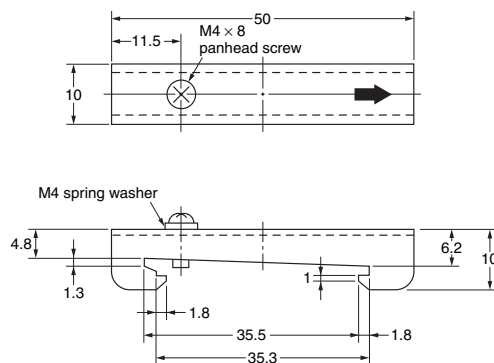
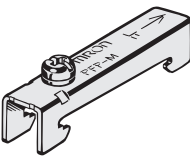

# E3X-SD/-NA

## Nomenclature

### Amplifier Units

#### E3X-SD

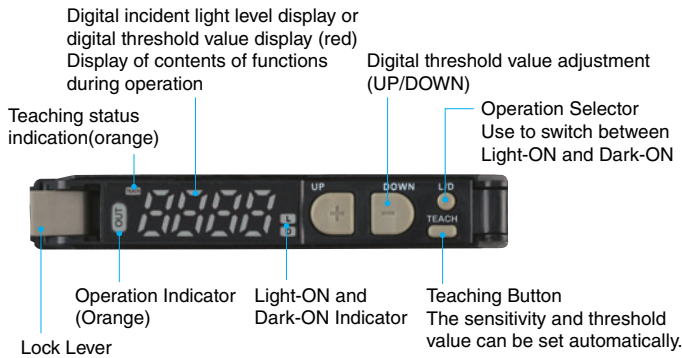

#### E3X-NA

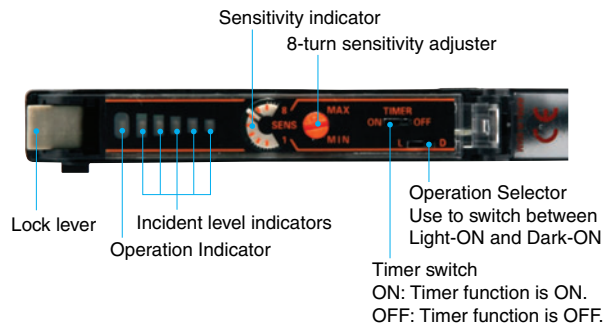

## Operating Procedure

### E3X-SD

#### 1 Sensitivity Setting

The sensitivity can be set with the UP and DOWN Keys similar to using an adjuster knob. The sensitivity can also be easily set by using the following two teaching functions.

##### 2-1. Teaching with/without a Workpiece

Two points (one with the workpiece and the other without) are detected, and the operating level is set to the midpoint. Light level is also automatically set to the optimal value.

Operation description	Button/Key
Press the TEACH button with the workpiece.	TEACH
Press the TEACH button without the workpiece.	TEACH

##### 2-2. Automatic Teaching





Changes within a time are detected, and the operating level is set to the midpoint between the maximum and the minimum values of the changes. This setting is optimal for when the workpieces cannot be stopped. Execute automatic teaching again if the incident light level is not automatically set to the optimal value.

Operation description	Button/Key
Press the TEACH button for 3 s min. Let the workpiece pass while the button is pressed.	TEACH

### E3X-NA

#### 1 Displays

A bar display (with four green and one red) showing excess gain is provided in addition to the orange operation indicator. Use these when adjusting the light axis and setting the sensitivity at setup.

Display/indicator status (for L/ON)	Excess gain level	Description
	Approx. 120% min.	Stable incident light
	Approx. 110% to 120%	
	Approx. 90% to 110%	Unstable incident light or Unstable interrupted light
	Approx. 80% to 90%	Stable interrupted light
	Approx. 80% max.	

## **READ AND UNDERSTAND THIS DOCUMENT**

Please read and understand this document before using the products. Please consult your OMRON representative if you have any questions or comments.

## **WARRANTY**

OMRON's exclusive warranty is that the products are free from defects in materials and workmanship for a period of one year (or other period if specified) from date of sale by OMRON.

OMRON MAKES NO WARRANTY OR REPRESENTATION, EXPRESS OR IMPLIED, REGARDING NON-INFRINGEMENT, MERCHANTABILITY, OR FITNESS FOR PARTICULAR PURPOSE OF THE PRODUCTS. ANY BUYER OR USER ACKNOWLEDGES THAT THE BUYER OR USER ALONE HAS DETERMINED THAT THE PRODUCTS WILL SUITABLY MEET THE REQUIREMENTS OF THEIR INTENDED USE. OMRON DISCLAIMS ALL OTHER WARRANTIES, EXPRESS OR IMPLIED.

## **LIMITATIONS OF LIABILITY**

OMRON SHALL NOT BE RESPONSIBLE FOR SPECIAL, INDIRECT, OR CONSEQUENTIAL DAMAGES, LOSS OF PROFITS OR COMMERCIAL LOSS IN ANY WAY CONNECTED WITH THE PRODUCTS, WHETHER SUCH CLAIM IS BASED ON CONTRACT, WARRANTY, NEGLIGENCE, OR STRICT LIABILITY.

In no event shall responsibility of OMRON for any act exceed the individual price of the product on which liability is asserted.

IN NO EVENT SHALL OMRON BE RESPONSIBLE FOR WARRANTY, REPAIR, OR OTHER CLAIMS REGARDING THE PRODUCTS UNLESS OMRON'S ANALYSIS CONFIRMS THAT THE PRODUCTS WERE PROPERLY HANDLED, STORED, INSTALLED, AND MAINTAINED AND NOT SUBJECT TO CONTAMINATION, ABUSE, MISUSE, OR INAPPROPRIATE MODIFICATION OR REPAIR.

## **SUITABILITY FOR USE**

THE PRODUCTS CONTAINED IN THIS DOCUMENT ARE NOT SAFETY RATED. THEY ARE NOT DESIGNED OR RATED FOR ENSURING SAFETY OF PERSONS, AND SHOULD NOT BE RELIED UPON AS A SAFETY COMPONENT OR PROTECTIVE DEVICE FOR SUCH PURPOSES. Please refer to separate catalogs for OMRON's safety rated products.

OMRON shall not be responsible for conformity with any standards, codes, or regulations that apply to the combination of products in the customer's application or use of the product.

At the customer's request, OMRON will provide applicable third party certification documents identifying ratings and limitations of use that apply to the products. This information by itself is not sufficient for a complete determination of the suitability of the products in combination with the end product, machine, system, or other application or use.

The following are some examples of applications for which particular attention must be given. This is not intended to be an exhaustive list of all possible uses of the products, nor is it intended to imply that the uses listed may be suitable for the products:

- Outdoor use, uses involving potential chemical contamination or electrical interference, or conditions or uses not described in this document.
- Nuclear energy control systems, combustion systems, railroad systems, aviation systems, medical equipment, amusement machines, vehicles, safety equipment, and installations subject to separate industry or government regulations.
- Systems, machines, and equipment that could present a risk to life or property.

Please know and observe all prohibitions of use applicable to the products.

NEVER USE THE PRODUCTS FOR AN APPLICATION INVOLVING SERIOUS RISK TO LIFE OR PROPERTY WITHOUT ENSURING THAT THE SYSTEM AS A WHOLE HAS BEEN DESIGNED TO ADDRESS THE RISKS, AND THAT THE OMRON PRODUCT IS PROPERLY RATED AND INSTALLED FOR THE INTENDED USE WITHIN THE OVERALL EQUIPMENT OR SYSTEM.

## **PERFORMANCE DATA**

Performance data given in this document is provided as a guide for the user in determining suitability and does not constitute a warranty. It may represent the result of OMRON's test conditions, and the users must correlate it to actual application requirements. Actual performance is subject to the OMRON Warranty and Limitations of Liability.

## **CHANGE IN SPECIFICATIONS**

Product specifications and accessories may be changed at any time based on improvements and other reasons.

It is our practice to change model numbers when published ratings or features are changed, or when significant construction changes are made. However, some specifications of the product may be changed without any notice. When in doubt, special model numbers may be assigned to fix or establish key specifications for your application on your request. Please consult with your OMRON representative at any time to confirm actual specifications of purchased products.

## **DIMENSIONS AND WEIGHTS**

Dimensions and weights are nominal and are not to be used for manufacturing purposes, even when tolerances are shown.

## **ERRORS AND OMISSIONS**

The information in this document has been carefully checked and is believed to be accurate; however, no responsibility is assumed for clerical, typographical, or proofreading errors, or omissions.

## **PROGRAMMABLE PRODUCTS**

OMRON shall not be responsible for the user's programming of a programmable product, or any consequence thereof.

## **COPYRIGHT AND COPY PERMISSION**

This document shall not be copied for sales or promotions without permission.

This document is protected by copyright and is intended solely for use in conjunction with the product. Please notify us before copying or reproducing this document in any manner, for any other purpose. If copying or transmitting this document to another, please copy or transmit it in its entirety.

This document provides information mainly for selecting suitable models. Please read the Instruction sheet carefully for information that the user must understand and accept before purchase, including information on warranty, limitations of liability, and precautions.

**OMRON Corporation Industrial Automation Company**

Tokyo, JAPAN

Contact: [www.ia.omron.com](http://www.ia.omron.com)

**Regional Headquarters**

**OMRON EUROPE B.V.**

**Sensor Business Unit**

Carl-Benz-Str. 4, D-71154 Nufringen, Germany  
Tel: (49) 7032-811-0/Fax: (49) 7032-811-199

**OMRON ELECTRONICS LLC**

One Commerce Drive Schaumburg,  
IL 60173-5302 U.S.A.  
Tel: (1) 847-843-7900/Fax: (1) 847-843-7787

**OMRON ASIA PACIFIC PTE. LTD.**

No. 438A Alexandra Road # 05-05/08 (Lobby 2),  
Alexandra Technopark,  
Singapore 119967  
Tel: (65) 6835-3011/Fax: (65) 6835-2711

**OMRON (CHINA) CO., LTD.**

Room 2211, Bank of China Tower,  
200 Yin Cheng Zhong Road,  
PuDong New Area, Shanghai, 200120, China  
Tel: (86) 21-5037-2222/Fax: (86) 21-5037-2200

**Authorized Distributor:**

© OMRON Corporation 2010 All Rights Reserved.  
In the interest of product improvement,  
specifications are subject to change without notice.

**CSM\_3\_1\_1010**

**Cat. No. E401-E1-01**

0110

# Mouser Electronics

Authorized Distributor

Click to View Pricing, Inventory, Delivery & Lifecycle Information:

[Omron:](#)

[E3X-NA6](#) [E3X-NA8](#)



Компания «ЭлектроПласт» предлагает заключение долгосрочных отношений при поставках импортных электронных компонентов на взаимовыгодных условиях!

Наши преимущества:

- Оперативные поставки широкого спектра электронных компонентов отечественного и импортного производства напрямую от производителей и с крупнейших мировых складов;
- Поставка более 17-ти миллионов наименований электронных компонентов;
- Поставка сложных, дефицитных, либо снятых с производства позиций;
- Оперативные сроки поставки под заказ (от 5 рабочих дней);
- Экспресс доставка в любую точку России;
- Техническая поддержка проекта, помощь в подборе аналогов, поставка прототипов;
- Система менеджмента качества сертифицирована по Международному стандарту ISO 9001;
- Лицензия ФСБ на осуществление работ с использованием сведений, составляющих государственную тайну;
- Поставка специализированных компонентов (Xilinx, Altera, Analog Devices, Intersil, Interpoint, Microsemi, Aeroflex, Peregrine, Syfer, Eurofarad, Texas Instrument, Miteq, Cobham, E2V, MA-COM, Hittite, Mini-Circuits, General Dynamics и др.);

Помимо этого, одним из направлений компании «ЭлектроПласт» является направление «Источники питания». Мы предлагаем Вам помощь Конструкторского отдела:

- Подбор оптимального решения, техническое обоснование при выборе компонента;
- Подбор аналогов;
- Консультации по применению компонента;
- Поставка образцов и прототипов;
- Техническая поддержка проекта;
- Защита от снятия компонента с производства.



#### Как с нами связаться

**Телефон:** 8 (812) 309 58 32 (многоканальный)

**Факс:** 8 (812) 320-02-42

**Электронная почта:** [org@eplast1.ru](mailto:org@eplast1.ru)

**Адрес:** 198099, г. Санкт-Петербург, ул. Калинина, дом 2, корпус 4, литера А.