

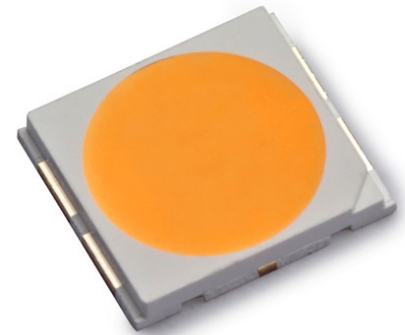

LUXEON 5258

Multi-die, single LED for effective single source lamps

LUXEON 5258 is a multi-die package LED that provides high luminance from a single package to enable cost effective, single optic and directional lamp designs. LUXEON 5258 uses an industry standard 5258 surface mount package and is available in 24V and 96V to interface with high efficiency drivers. LUXEON 5258 comes in 2700K and 3000K, 80CRI and offers hot-color targeting to ensure that the LEDs are within color target at application conditions of 85°C.



FEATURES AND BENEFITS

- 5mm optical source enables good optic design for great punch
- Hot-color targeting ensures color is within ANSI bin at 85°C
- Binned within 3-step and 5-step MacAdam ellipse ensuring color uniformity
- Compatible with low cost and high efficiency drivers
- Available in 24V and 96V options

PRIMARY APPLICATIONS

- Lamps
- Spotlights

Table of Contents

General Information	2
Nomenclature Test Conditions	2
Nomenclature Test Conditions	2
Lumen Maintenance	2
Environmental Compliance	2
Performance Characteristics	3
Absolute Maximum Ratings	4
Characteristic Curves	5
Radiation Patterns	8
Color Bin Definition.....	9
Mechanical Dimensions	10
Reflow Soldering Characteristics.....	11
JEDEC Moisture Sensitivity.....	11
Packaging Information.....	12
Reel Dimensions.....	12

General Information

Nomenclature Test Conditions

LUXEON 5258 LEDs are specified and binned at 160mA for 24V products and 40mA for 96V products, $T_j = 25^\circ\text{C}$.

Nomenclature Test Conditions

The part number designation for LUXEON 5258 is explained as follows:

L 1 5 2 – A A B B 5 0 D D 0 0 0 0 0

Where:

AA — designates CCT (27=2700K and 30=3000K)

BB — designates minimum CRI (80=80CRI)

DD — designates forward voltage (24=24V and 96=96V)

Therefore, a LUXEON 5258 3000K, 80CRI and 24V will have the following part number:

L 1 5 2 – 3 0 8 0 5 0 2 4 0 0 0 0 0

Lumen Maintenance

Lumen maintenance for solid-state lighting devices (LEDs) is typically defined in terms of the percentage of initial light output remaining after a specified period of time. Observation of design limits included in this data sheet is required.

Environmental Compliance

Lumileds is committed to providing environmentally friendly products to the solid-state lighting market. LUXEON LEDs are compliant to the European Union directives on the restriction of hazardous substances in electronic equipment, namely the RoHS and REACH directives. Lumileds will not intentionally add the following restricted material to the product: lead, mercury, cadmium, hexavalent chromium, polybrominated biphenyls (PBB) or polybrominated diphenyl ethers (PBDE).

Performance Characteristics

Product Selection Guide

Table 1. Product performance for LUXEON 5258 at test current, $T_j=25^\circ\text{C}$.

Voltage	Nominal CCT	Typical CRI	Luminous Flux (lm) ^[1]		Typical Luminous Efficacy (lm/W)	Test Current (mA)	Part Number
			Minimum	Typical			
24V	2700K	82	460	485	121	160	L152-2780502400000
	3000K	82	475	500	125	160	L152-3080502400000
96V	2700K	82	420	445	115	40	L152-2780509600000
	3000K	82	430	458	118	40	L152-3080509600000

Notes for Table 1:

1. Lumileds maintains a tolerance of $\pm 7\%$ on luminous flux, ± 2 on CRI.

Optical Characteristics

Table 2. Optical characteristics for LUXEON 5258 at test current, $T_j=25^\circ\text{C}$.

Part Number	Typical Total Included Angle	Typical Viewing Angle
L152-xx8050xx00000	135°	115°

Notes for Table 2:

1. Total angle at which 90% of total luminous flux is captured.
2. Viewing angle is the off axis angle from lamp centerline where the luminous intensity is 1/2 of the peak value.

Electrical Characteristics

Table 3. Electrical characteristics for LUXEON 5258.

Part Number	Test Current (mA)	Forward Voltage (V) ^[2]			Temperature Coefficient of Forward Voltage (mV/°C)	Typical Thermal Resistance Junction to Solder Pad (°C/W)
		Minimum	Typical	Maximum		
L152-xx80502400000	160	22	25	27	-17	1.5
L152-xx80509600000	40	96	97	98	-50	1.5

Notes for Table 3:

1. Measured between $T_j = 25^\circ\text{C}$ and $T_j = 105^\circ\text{C}$ at test current.
2. Lumileds maintains a voltage tolerance $\pm 6\%$.

Absolute Maximum Ratings

Table 4. Absolute Maximum Ratings for LUXEON 5258.

Parameter	Maximum Performance
DC Forward Current	24V = 240mA 96V = 60mA
Peak Pulsed Forward Current ⁽¹⁾	24V = 300mA 96V = 80mA
ESD Sensitivity	≤ 8000V Human Body Model (HBM) Class 3B JS-001-2012< 400V Machine Model (MM) Class B JESD22-A115-B
Storage Temperature	-40°C - 105°C
LED Junction Temperature (DC / pulse)	125°C
LED Operating Case Temperature (DC / pulse)	-40°C - 105°C
Reverse Voltage ($V_{reverse}$)	LUXEON LEDs are not designed to be driven in reverse bias

Notes for Table 4:

1. At 10% duty cycle and pulse width 10ms.

Characteristic Curves

Spectral Distribution

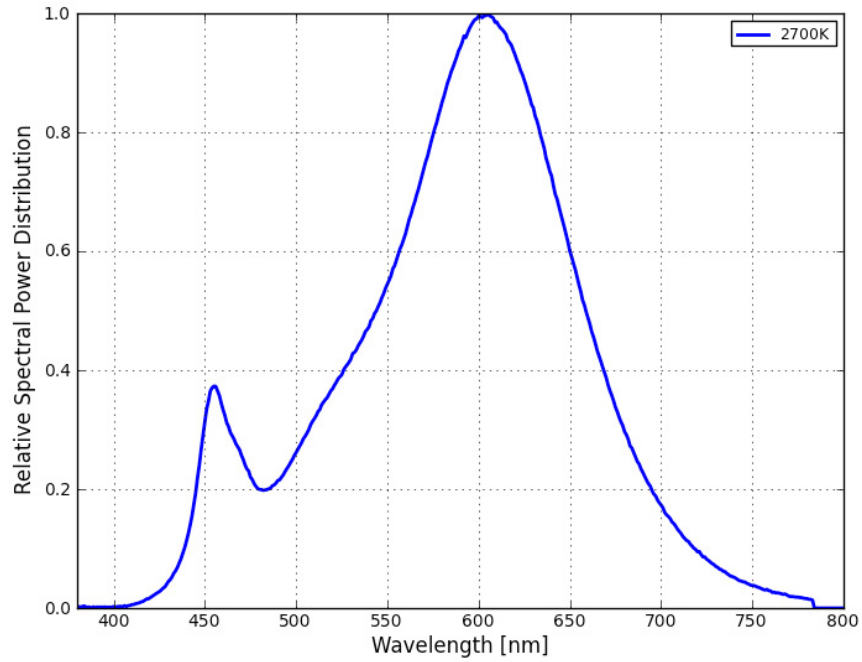

Figure 1. Typical normalized power vs. wavelength for L152-xx80050xx00000 at test current, $T_j=25^{\circ}\text{C}$.

Light Output Characteristics

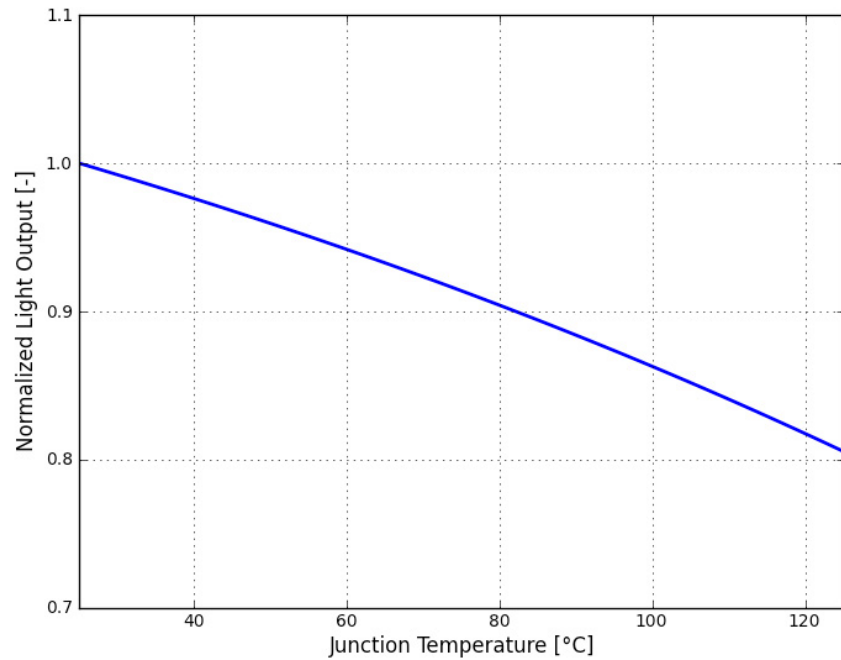

Figure 2a. Typical normalized light output vs. junction temperature for L152-xx80050xx00000 at test current.

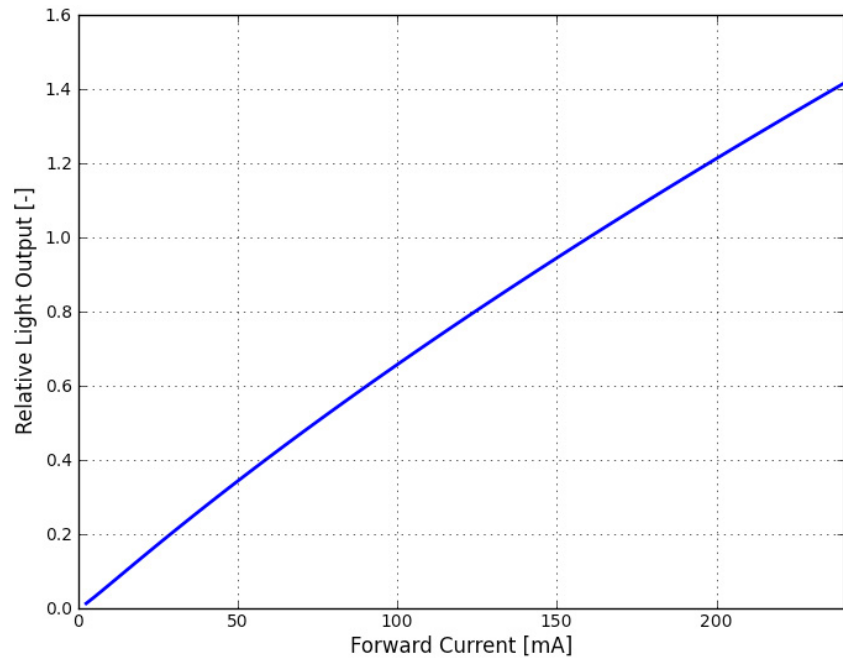

Figure 2b. Typical normalized light output vs. forward current for L152-xx800502400000 at $T_j=25^{\circ}\text{C}$.

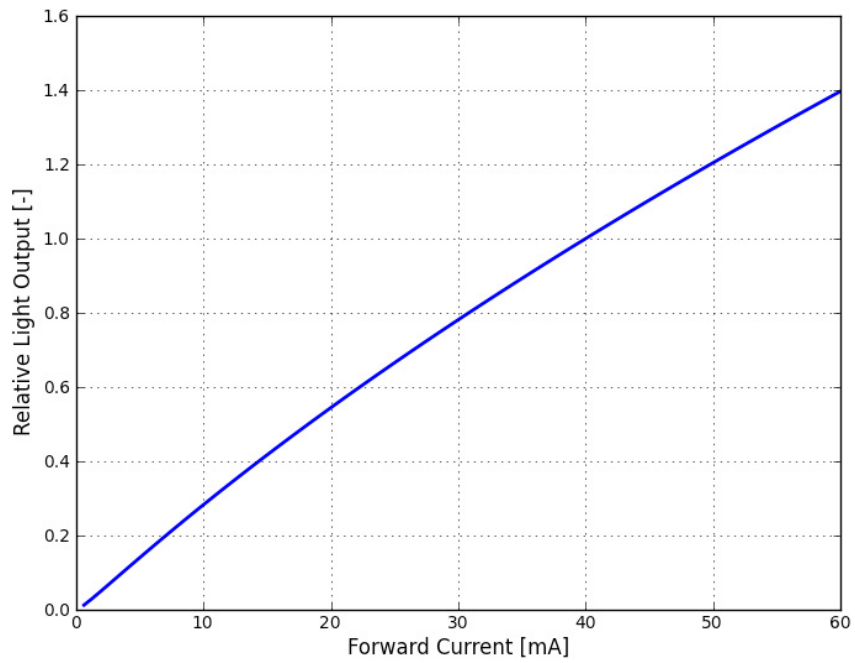

Figure 2c. Typical normalized light output vs. forward current for L152-xx800509600000 at $T_j=25^{\circ}\text{C}$.

Forward Current Characteristics

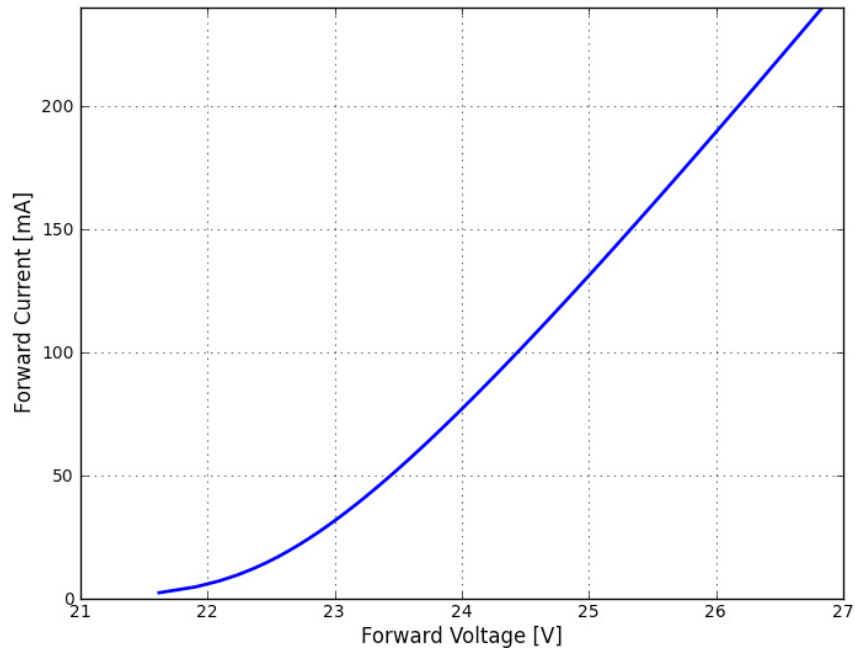

Figure 3a. Typical forward current vs. forward voltage for L152-xx800502400000 at $T_j=25^{\circ}\text{C}$.

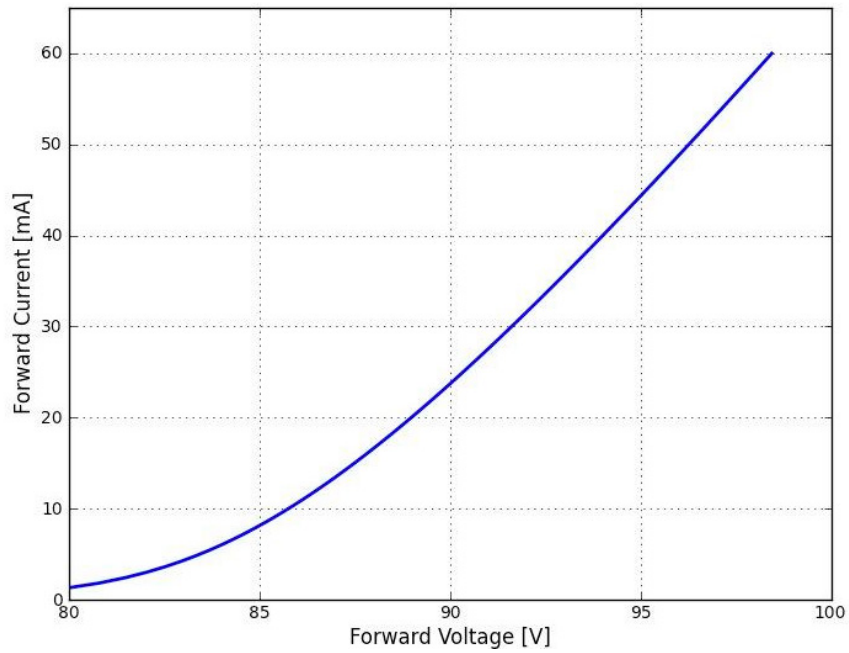

Figure 3b. Typical forward current vs. forward voltage for L152-xx800509600000 at $T_j=25^{\circ}\text{C}$.

Radiation Patterns

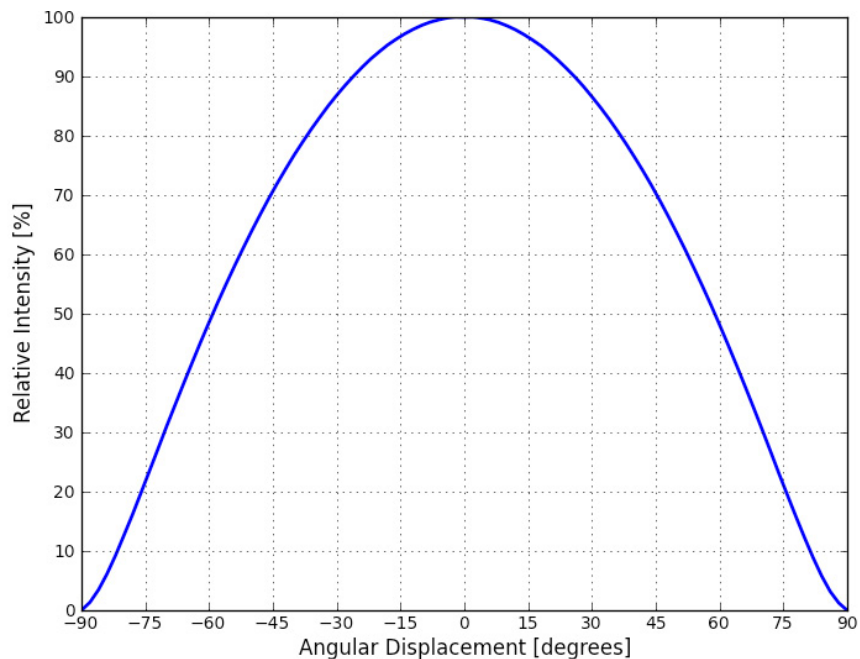

Figure 4a. Typical radiation pattern for L152-xx80050xx00000 at test current, $T_j=25^{\circ}\text{C}$.

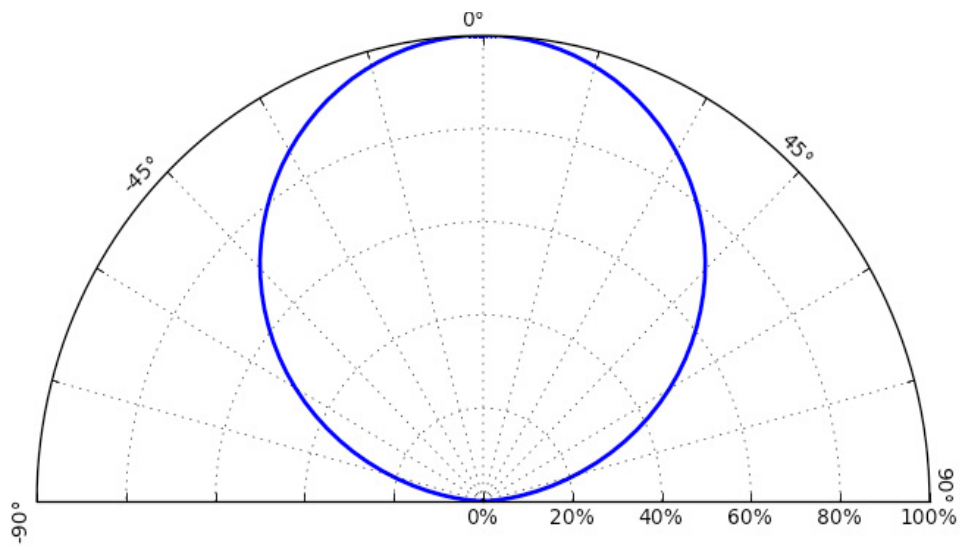

Figure 4b. Typical polar radiation pattern for L152-xx80050xx00000 at test current, $T_j=25^{\circ}\text{C}$.

Color Bin Definition

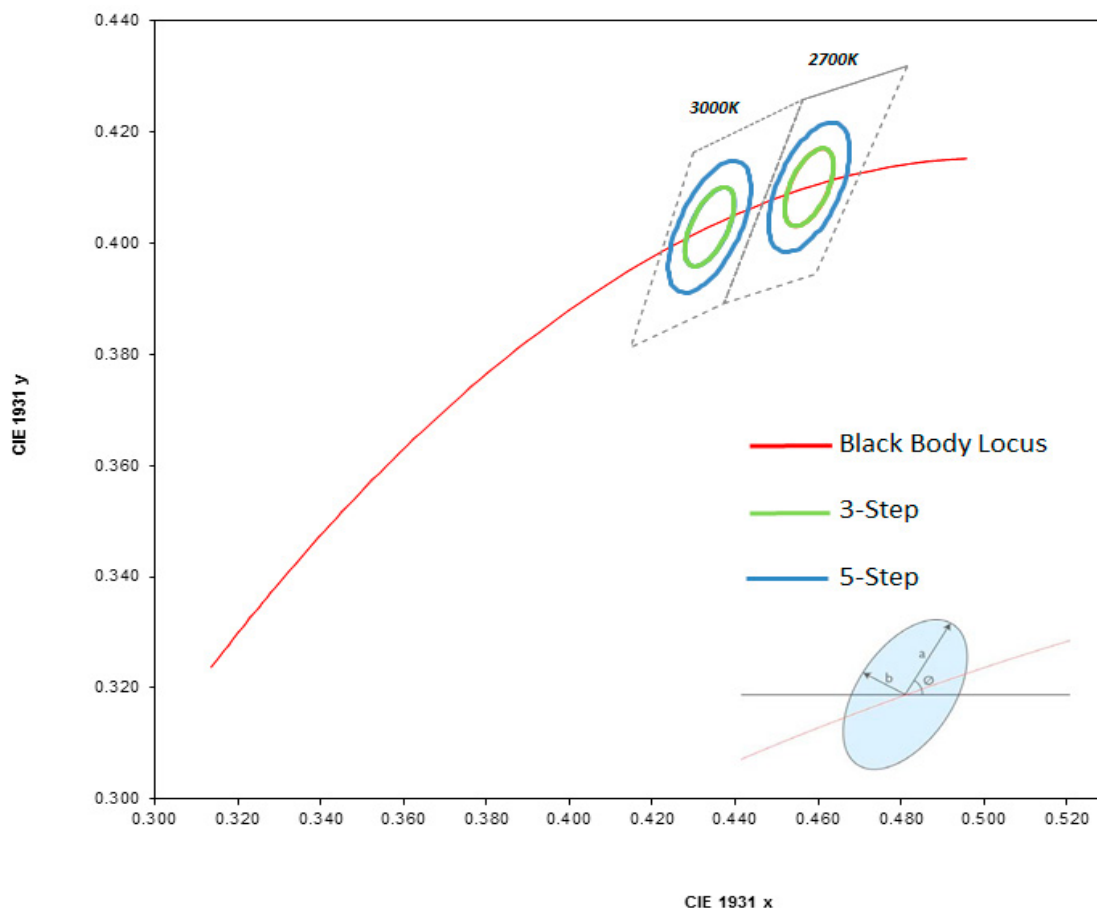

Figure 5. 3-Step and 5-Step MacAdam ellipse color bin illustration for Table 5.

Table 5. 3-Step and 5-Step MacAdam Ellipse Color Definition for LUXEON 5258

Nominal ANSI CCT	Color Space	Target Center Point (cx, cy)	Major Axis, a	Minor Axis, b	Ellipse Rotation Angle
2700K	Single 3-step MacAdam ellipse	(0.4604,0.4151)	0.00810	0.00420	53.70°
3000K	Single 3-step MacAdam ellipse	(0.4373,0.4090)	0.00834	0.00408	53.22°
2700K	Single 5-step MacAdam ellipse	(0.4604,0.4151)	0.01350	0.00700	53.70°
3000K	Single 5-step MacAdam ellipse	(0.4373,0.4090)	0.01390	0.00680	53.22°

Note for Table 5:

- Lumileds maintains a tester tolerance of ± 0.005 on x,y coordinates.
- Major and minor axis (a,b) from table 5 are a reference as depicted in figure 5.

Mechanical Dimensions

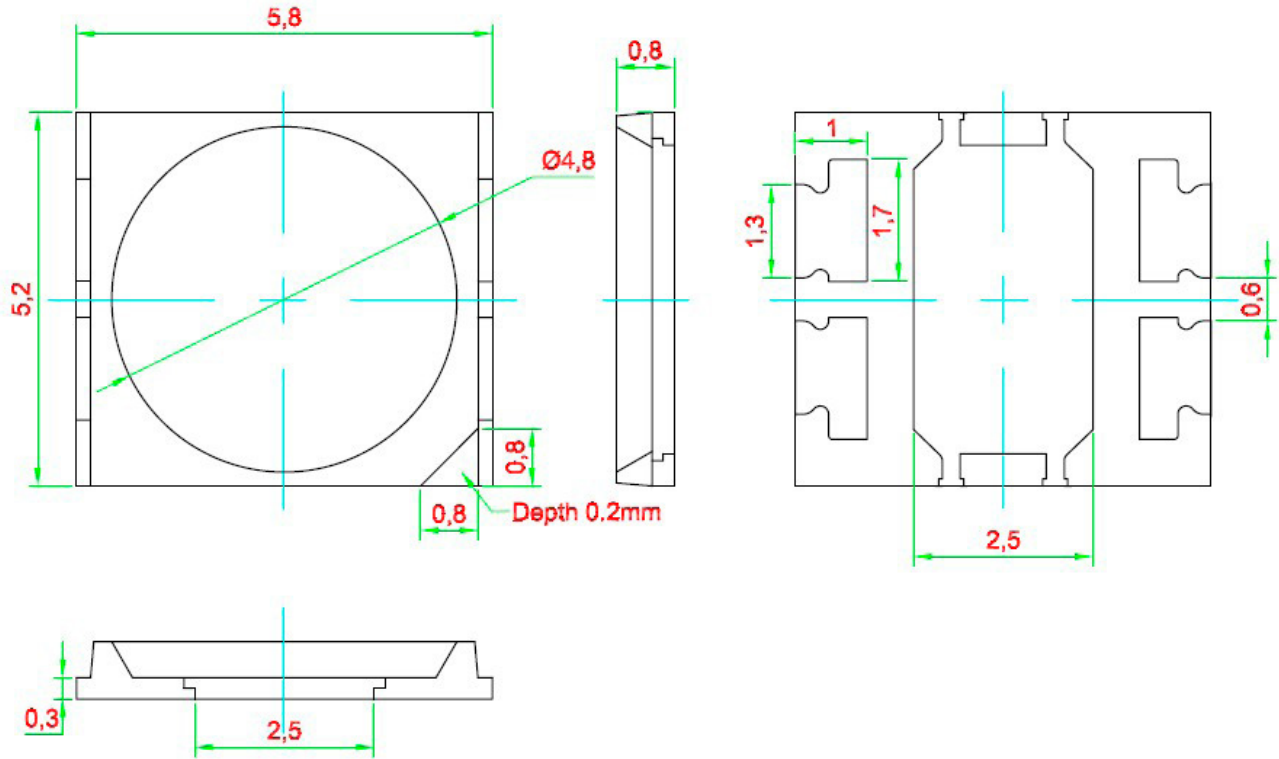

Figure 6. Mechanical dimensions for LUXEON 5258.

Notes for Figure 6:

1. Drawings not to scale.
2. All dimensions are in millimeters.
3. Dimensional tolerance ($\pm 0.1\text{mm}$).

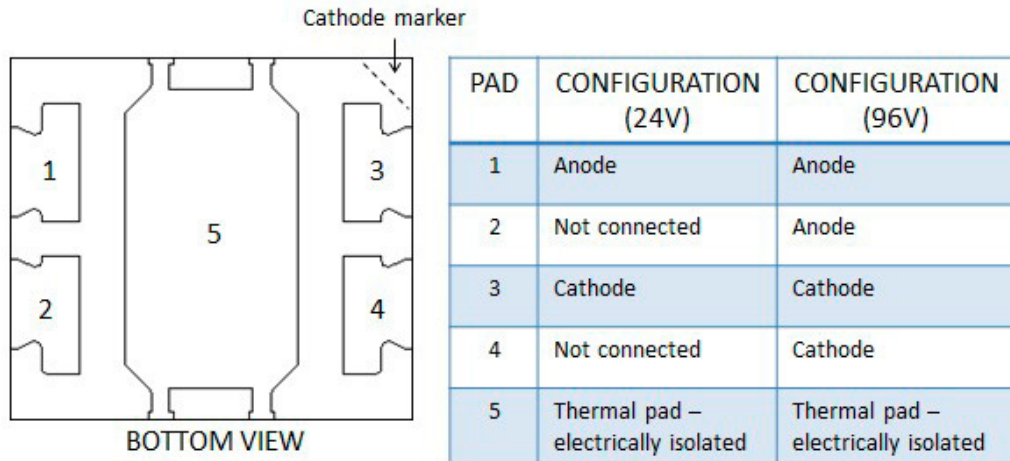

Figure 7. Pad design details for LUXEON 5258.

Reflow Soldering Characteristics

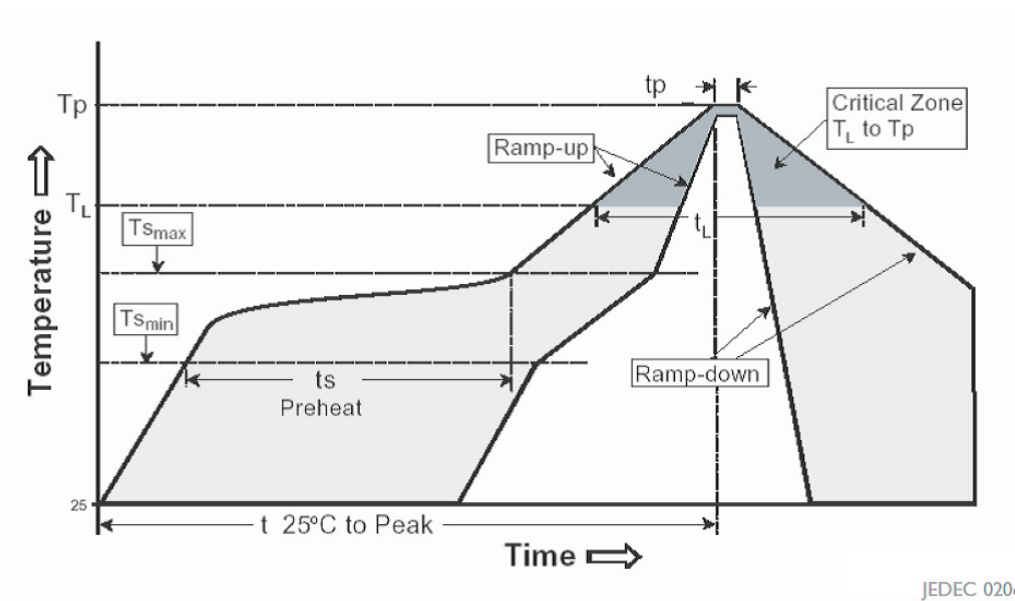

Figure 8. Temperature profile for Table 6.

Table 6. Reflow profile characteristics for LUXEON 5258.

Profile Feature	Lead Free Assembly
Preheat/Soak: Temperature Min ($T_{s_{min}}$) Temperature Max ($T_{s_{max}}$) Maximum Time (t_s) from $T_{s_{min}}$ to $T_{s_{max}}$	150°C 200°C 60 – 180 seconds
Average Ramp-up Rate ($T_{s_{max}}$ to T_p)	3°C / second
Liquidous Temperature (T_L)	217°C
Maximum Time Maintained Above Temperature t_L	60 – 150 seconds
Peak / Classification Temperature (T_p)	260°C
Time (t_p) within 5°C of the actual temperature (t_p)	20 - 40 seconds
Ramp-Down Rate (T_p to T_L)	6°C / second
Time 25°C to Peak Temperature	8 minutes max

Notes for Table 6:

- All temperatures refer to the application Printed Circuit Board (PCB), measured on the surface adjacent to the package body.

JEDEC Moisture Sensitivity

Table 7. JEDEC Moisture sensitivity for LUXEON 5258.

Level	Floor Life		Soak Requirements Standard	
	Time	Conditions	Time	Conditions
2	1 year	30°C / 60% RH (Relative Humidity)	168 Hrs. ± 5/0 Hrs.	85°C / 60% RH

Packaging Information

Pocket Tape Dimensions

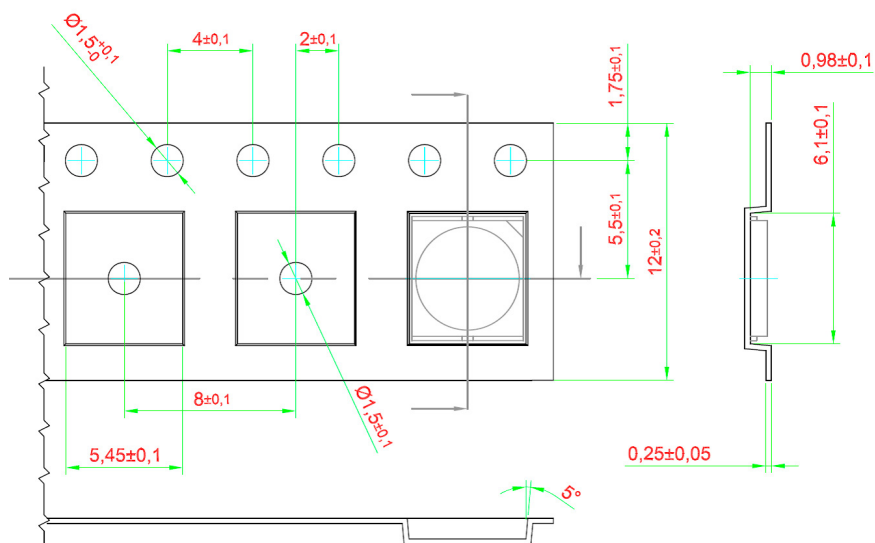

Figure 9. Pocket tape dimensions for LUXEON 5258.

Notes for Figure 9:

1. All dimensions are in millimeters.

Reel Dimensions

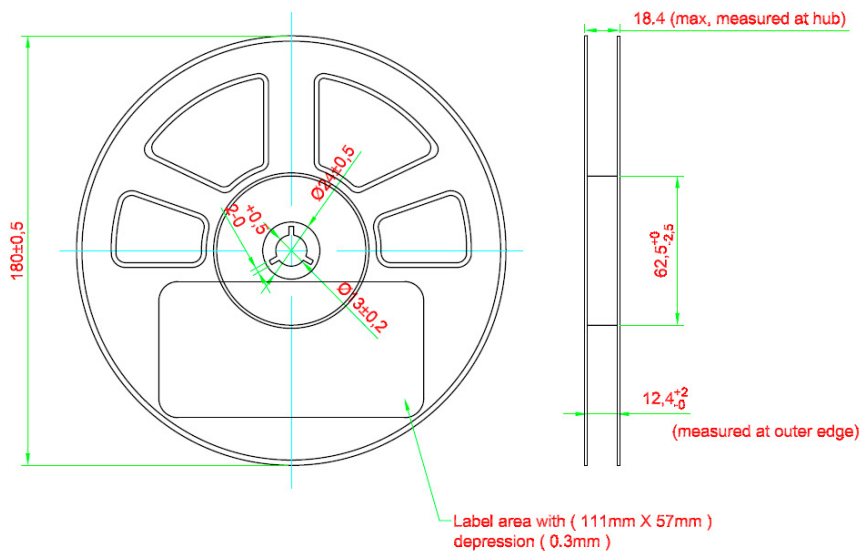

Figure 10. Reel dimensions for LUXEON 5258.

Notes for Figure 10:

1. All dimensions are in millimeters.
2. The maximum of empty single pockets is 2.
3. No consecutive empty pockets are allowed.
4. Empty component pockets sealed with top cover tape.
5. The 7 inch reel -1000 pieces per reel.
6. Emitter pocket spacing is 8mm.
7. Comply with EIA-481-1-B specifications.

About Lumileds

Lumileds is the light engine leader, delivering innovation, quality, and reliability.

For 100 years, Lumileds commitment to innovation has helped customers pioneer breakthrough products in the automotive, consumer and illumination markets.

Lumileds is shaping the future of light with our LEDs and automotive lamps, and helping our customers illuminate how people see the world around them.

To learn more about our portfolio of light engines visit www.lumileds.com.



©2015 Lumileds Holding B.V. All rights reserved.
LUXEON is a registered trademark of the Lumileds Holding B.V.
in the United States and other countries.

www.lumileds.com

Neither Lumileds Holding B.V. nor its affiliates shall be liable for any kind of loss of data or any other damages, direct, indirect or consequential, resulting from the use of the provided information and data. Although Lumileds Holding B.V. and/or its affiliates have attempted to provide the most accurate information and data, the materials and services information and data are provided "as is," and neither Lumileds Holding B.V. nor its affiliates warrants or guarantees the contents and correctness of the provided information and data. Lumileds Holding B.V. and its affiliates reserve the right to make changes without notice. You as user agree to this disclaimer and user agreement with the download or use of the provided materials, information and data.



Компания «ЭлектроПласт» предлагает заключение долгосрочных отношений при поставках импортных электронных компонентов на взаимовыгодных условиях!

Наши преимущества:

- Оперативные поставки широкого спектра электронных компонентов отечественного и импортного производства напрямую от производителей и с крупнейших мировых складов;
- Поставка более 17-ти миллионов наименований электронных компонентов;
- Поставка сложных, дефицитных, либо снятых с производства позиций;
- Оперативные сроки поставки под заказ (от 5 рабочих дней);
- Экспресс доставка в любую точку России;
- Техническая поддержка проекта, помощь в подборе аналогов, поставка прототипов;
- Система менеджмента качества сертифицирована по Международному стандарту ISO 9001;
- Лицензия ФСБ на осуществление работ с использованием сведений, составляющих государственную тайну;
- Поставка специализированных компонентов (Xilinx, Altera, Analog Devices, Intersil, Interpoint, Microsemi, Aeroflex, Peregrine, Syfer, Eurofarad, Texas Instrument, Miteq, Cobham, E2V, MA-COM, Hittite, Mini-Circuits, General Dynamics и др.);

Помимо этого, одним из направлений компании «ЭлектроПласт» является направление «Источники питания». Мы предлагаем Вам помощь Конструкторского отдела:

- Подбор оптимального решения, техническое обоснование при выборе компонента;
- Подбор аналогов;
- Консультации по применению компонента;
- Поставка образцов и прототипов;
- Техническая поддержка проекта;
- Защита от снятия компонента с производства.



Как с нами связаться

Телефон: 8 (812) 309 58 32 (многоканальный)

Факс: 8 (812) 320-02-42

Электронная почта: org@eplast1.ru

Адрес: 198099, г. Санкт-Петербург, ул. Калинина, дом 2, корпус 4, литера А.