300mA LDO REGULATOR

NO. EA-236-141222

OUTLINE

The RP114x Series are CMOS-based voltage regulator ICs with high output voltage accuracy, low supply current, low dropout, and high ripple rejection. Each of these voltage regulator ICs consists of a voltage reference unit, an error amplifier, resistors for setting output voltage, a short current limit circuit, a chip enable circuit, and so on.

RP114x features a minimum input voltage from 1.4V and the output voltage, which can be set from 0.8V to 3.6V (in 0.1V step). The output voltage of these ICs is internally fixed.

These ICs perform with low dropout voltage due to built-in transistor with low ON resistance. Low supply current and a chip enable function prolong the battery life of each system. The ripple rejection, line transient response and load transient response of the RP114x Series are excellent, thus these ICs are very suitable for the power supply for hand-held communication equipment.

Since the packages for these ICs are DFN(PLP)1010-4, SC-88A, SOT-23-5, therefore high density mounting of the ICs on boards is possible.

FEATURES

- Supply Current Typ. 50 μ A
- Standby Current Typ. 0.1 μ A
- Input Voltage Range 1.4V to 5.25V
- Output Voltage Range 0.8V to 3.6V (0.1V steps)
(For other voltages, please refer to *Mark Specification Table*).
- Output Voltage Accuracy $\pm 1.0\%$ ($V_{SET} > 2.0V$, $T_{opt} = 25^{\circ}C$)
- Temperature-Drift Coefficient of Output Voltage Typ. ± 80 ppm/ $^{\circ}C$
- Dropout Voltage Typ. 0.25V ($I_{OUT} = 300mA$, $V_{SET} = 2.8V$)
- Ripple Rejection Typ. 75dB ($f = 1kHz$)
- Line Regulation Typ. 0.02%/V
- Packages DFN(PLP)1010-4, SC-88A, SOT-23-5
- Built-in Fold Back Protection Circuit Typ. 60mA (Current at short mode)
- Ceramic capacitors are recommended to be used with this IC 1.0 μ F or more

APPLICATIONS

- Power source for portable communication equipment.
- Power source for electrical appliances such as cameras, VCRs and camcorders.
- Power source for battery-powered equipment.

RP114x

NO. EA-236-141222

BLOCK DIAGRAMS



SELECTION GUIDE

The set output voltage, the auto discharge function, and the package type for the ICs are user-selectable options.

Product Name	Package	Quantity per Reel	Pb Free	Halogen Free
RP114Kxx1*(y)-TR	DFN(PLP)1010-4	10,000 pcs	Yes	Yes
RP114Qxx2*(y)-TR-FE	SC-88A	3,000 pcs	Yes	Yes
RP114Nxx1*(y)-TR-FE	SOT-23-5	3,000 pcs	Yes	Yes

xx: Specify the set output voltage within the range of 0.8 V (08) to 3.6 V (36) in 0.1 V step.

(y): If the output voltage includes the 3rd digit, indicate the digit of 0.01V.

(1.05 V, 1.15 V, 1.25 V, 1.35 V, 1.75 V, 1.85 V, 2.85 V, 3.45 V)

Ex. If the output voltage is 1.25V, RP114K121*5-TR

If the output voltage is 1.85V, RP114K181*5-TR

*: Specify a combination of the CE pin polarity and the auto-discharge function.

(B) "H" Active, without Auto-Discharge function

(D) "H" Active, with Auto-Discharge function

Auto-Discharge function quickly lowers the output voltage to 0V by releasing the electrical charge in the external capacitor when the chip enable signal is switched from the active mode to the standby mode.

PIN DESCRIPTIONS

• DFN(PLP)1010-4



• SC-88A

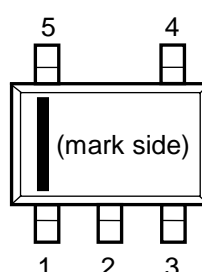

• SOT-23-5



• DFN(PLP)1010-4

Pin No	Symbol	Pin Description
1	V_{OUT}	Output Pin
2	GND	Ground Pin
3	CE	Chip Enable Pin ("H" Active)
4	V_{DD}	Input Pin

*) Tab is GND level. (They are connected to the reverse side of this IC.)

The tab is better to be connected to the GND, but leaving it open is also acceptable.

• SC-88A

Pin No	Symbol	Pin Description
1	CE	Chip Enable Pin ("H" Active)
2	NC	No Connection
3	GND	Ground Pin
4	V_{OUT}	Output Pin
5	V_{DD}	Input Pin

• SOT-23-5

Pin No	Symbol	Pin Description
1	V_{DD}	Input Pin
2	GND	Ground Pin
3	CE	Chip Enable Pin ("H" Active)
4	NC	No Connection
5	V_{OUT}	Output Pin

ABSOLUTE MAXIMUM RATINGS

Symbol	Item	Rating	Unit
V _{IN}	Input Voltage	6.0	V
V _{CE}	Input Voltage (CE Pin)	6.0	V
V _{OUT}	Output Voltage	-0.3 to V _{IN} +0.3	V
I _{OUT}	Output Current	400	mA
P _D	Power Dissipation (DFN(PLP)1010-4)*	400	mW
	Power Dissipation (SC-88A)*	380	
	Power Dissipation (SOT-23-5)*	420	
T _{opt}	Operating Temperature Range	-40 to 85	°C
T _{stg}	Storage Temperature Range	-55 to 125	°C

*) For Power Dissipation, please refer to *PACKAGE INFORMATION*.

ABSOLUTE MAXIMUM RATINGS

Electronic and mechanical stress momentarily exceeded absolute maximum ratings may cause the permanent damages and may degrade the life time and safety for both device and system using the device in the field. The functional operation at or over these absolute maximum ratings is not assured.

RECOMMENDED OPERATING CONDITIONS (ELECTRICAL CHARACTERISTICS)

All of electronic equipment should be designed that the mounted semiconductor devices operate within the recommended operating conditions. The semiconductor devices cannot operate normally over the recommended operating conditions, even if when they are used over such conditions by momentary electronic noise or surge. And the semiconductor devices may receive serious damage when they continue to operate over the recommended operating conditions.

ELECTRICAL CHARACTERISTICS

• RP114x

$V_{IN}=V_{SET}+1.0V$ ($V_{SET} > 1.5V$), $V_{IN}=2.5V$ ($V_{SET} \leq 1.5V$), $I_{OUT}=1mA$, $C_{IN}=C_{OUT}=1.0\mu F$, unless otherwise noted.

V_{SET} is Set Output Voltage.

The specifications in are guaranteed by design engineering at $-40^{\circ}C \leq T_a \leq 85^{\circ}C$.

RP114xxxxB/D

($T_a=25^{\circ}C$)

Symbol	Item	Conditions	Min.	Typ.	Max.	Unit
V_{OUT}	Output Voltage	$T_a=25^{\circ}C$	$V_{SET} > 2.0V$	$\times 0.99$	$\times 1.01$	V
			$V_{SET} \leq 2.0V$	-20	+20	mV
		$-40^{\circ}C \leq T_a \leq 85^{\circ}C$	$V_{SET} > 2.0V$	$\times 0.97$	$\times 1.03$	V
			$V_{SET} \leq 2.0V$	-60	+60	mV
I_{OUT}	Output Current		300		mA	
$\frac{\Delta V_{OUT}}{\Delta I_{OUT}}$	Load Regulation	$1mA \leq I_{OUT} \leq 300mA$		15	40	mV
V_{DIF}	Dropout Voltage	Please refer to <i>Dropout Voltage</i> shown on the next page.				
I_{SS}	Supply Current	$I_{OUT} = 0mA$		50	75	μA
$I_{standby}$	Standby Current	$V_{CE} = 0V$		0.1	1.0	μA
$\frac{\Delta V_{OUT}}{\Delta V_{IN}}$	Line Regulation	$V_{SET}+0.5V \leq V_{IN} \leq 5.25V$ ($V_{IN} \geq 1.4V$)		0.02	0.10	%/V
RR	Ripple Rejection	$f=1kHz$ Ripple 0.2Vp-p $V_{IN}=V_{SET}+1V$ $I_{OUT}=30mA$ (When $V_{SET} \leq 2.0V$, $V_{IN}=3.0V$)		75		dB
V_{IN}	Input Voltage ^{*2}		1.4		5.25	V
$\frac{\Delta V_{OUT}}{\Delta T_a}$	Output Voltage Temperature Coefficient	$-40^{\circ}C \leq T_a \leq 85^{\circ}C$		± 80		ppm/ $^{\circ}C$
I_{SC}	Short Current Limit	$V_{OUT}=0V$		60		mA
I_{PD}	CE Pull-down Current			0.3	0.6	μA
V_{CEH}	CE Input Voltage "H"		1.0			V
V_{CEL}	CE Input Voltage "L"				0.4	V
en	Output Noise	$BW=10Hz$ to $100kHz$ $I_{OUT}=30mA$		75		μV_{rms}
R_{LOW}	LOW Output Nch On Resistance (D version only)	$V_{IN}=4.0V$ $V_{CE}=0V$		50		Ω

All test items listed under *Electrical Characteristics* are done under the pulse load condition ($T_j \approx T_a = 25^{\circ}C$) except for Output Noise, Ripple Rejection, and Output Voltage Temperature Coefficient.

^{*2} The maximum input voltage listed under *Electrical Characteristics* is 5.25V. If, for any reason the input voltage exceeds 5.25V, it has to be no more than 5.5V with 500hrs of the total operating time.

RP114x

NO. EA-236-141222

The specifications in are guaranteed by design engineering at $-40^{\circ}\text{C} \leq T_a \leq 85^{\circ}\text{C}$.

Dropout Voltage by Set Output Voltage

(Ta=25°C)

Set Output Voltage V_{SET} (V)	Dropout Voltage V_{DIF} (V)		
	Condition	Typ.	Max.
$V_{\text{SET}}=0.8$	I _{OUT} =300mA	0.560	<input type="text" value="0.720"/>
$V_{\text{SET}}=0.9$		0.510	<input type="text" value="0.650"/>
$1.0 \leq V_{\text{SET}} < 1.2$		0.460	<input type="text" value="0.590"/>
$1.2 \leq V_{\text{SET}} < 1.4$		0.390	<input type="text" value="0.500"/>
$1.4 \leq V_{\text{SET}} < 1.7$		0.350	<input type="text" value="0.440"/>
$1.7 \leq V_{\text{SET}} < 2.1$		0.300	<input type="text" value="0.390"/>
$2.1 \leq V_{\text{SET}} < 2.5$		0.260	<input type="text" value="0.340"/>
$2.5 \leq V_{\text{SET}} < 3.0$		0.250	<input type="text" value="0.300"/>
$3.0 \leq V_{\text{SET}} \leq 3.6$		0.220	<input type="text" value="0.290"/>

TYPICAL APPLICATIONS



(External Components)

C2 Ceramic 1.0 μ F MURATA: GRM155B31A105KE15

TECHNICAL NOTES

When using these ICs, consider the following points:

Phase Compensation

In these ICs, phase compensation is made for securing stable operation even if the load current is varied. For this purpose, use a capacitor C2 with 1.0 μ F or more and good ESR (Equivalent Series Resistance).

(Note: If additional ceramic capacitors are connected with parallel to the output pin with an output capacitor for phase compensation, the operation might be unstable. Because of this, test these ICs with as same external components as ones to be used on the PCB.)

PCB Layout

Make V_{DD} and GND lines sufficient. If their impedance is high, noise pickup or unstable operation may result. Connect a capacitor C1 with a capacitance value as much as 1.0 μ F or more between V_{DD} and GND pin, and as close as possible to the pins.

Set external components, especially the output capacitor C2, as close as possible to the ICs, and make wiring as short as possible.

PACKAGE INFORMATION

Power Dissipation (DFN(PLP)1010-4)

Power Dissipation (P_D) depends on conditions of mounting on board. This specification is based on the Measurement Conditions below.

Measurement Conditions

	Standard Land Pattern
Environment	Mounting on Board (Wind Velocity=0m/s)
Board Material	Glass Cloth Epoxy Plastic (Double-sided)
Board Dimensions	40mm x 40mm x 1.6mm
Copper Ratio	Top-side: Approx. 50%, Back-side: Approx. 50%
Through-hole	ϕ 0.54mm x 24pcs

Measurement Result

($T_a=25^\circ\text{C}$)

	Standard Land Pattern
Power Dissipation	400mW ($T_{jmax}=125^\circ\text{C}$) 500mW ($T_{jmax}=150^\circ\text{C}$)
Thermal Resistance	$\theta_{ja}=(125-25^\circ\text{C})/0.4\text{W}=250^\circ\text{C/W}$ $\theta_{jc}=67^\circ\text{C/W}$



Power Dissipation



Measurement Board Pattern

IC Mount Area (Unit: mm)

Note: The above graph shows the power dissipation of the package based on $T_{jmax}=125^\circ\text{C}$ and $T_{jmax}=150^\circ\text{C}$. Operating the IC within the shaded area in the graph might have an influence on its lifetime.

Operating time must be within the time limit described in the table below.

Operating Time	Estimated Years (Operating 4 hrs/ day)
13,000 hours	9 Years

Package Dimensions (DFN(PLP)1010-4)

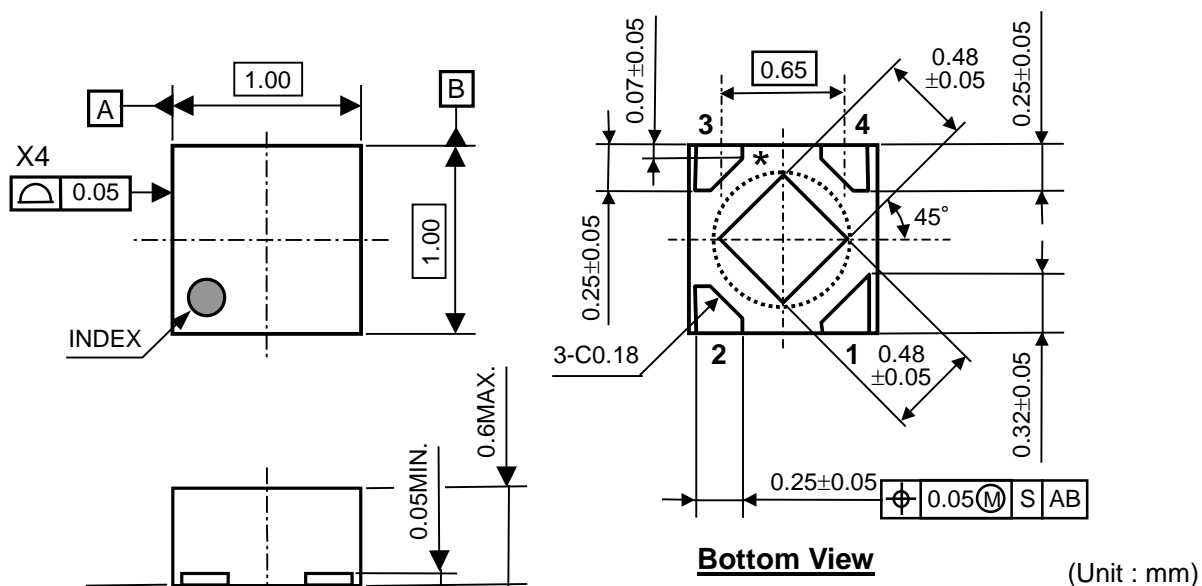

* The tab is substrate level (GND).
The tab is better to be connected to the GND, but leaving it open is also acceptable.

Mark Specification (DFN(PLP)1010-4)

- ①②: Product CodePlease refer to RP114K Mark Specification Table.
- ③④: Lot Number.....Alphanumeric Serial Number

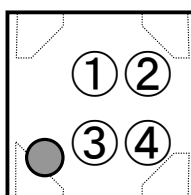

RP114xNO. EA-236-141222

Mark Specification Table (DFN(PLP)1010-4)**RP114Kxx1B**

Product Name	①②	V _{SET}
RP114K081B	L 0	0.8V
RP114K091B	L 1	0.9V
RP114K101B	L 2	1.0V
RP114K111B	L 3	1.1V
RP114K121B	L 4	1.2V
RP114K131B	L 5	1.3V
RP114K141B	L 6	1.4V
RP114K151B	L 7	1.5V
RP114K161B	L 8	1.6V
RP114K171B	L 9	1.7V
RP114K181B	M 0	1.8V
RP114K191B	M 1	1.9V
RP114K201B	M 2	2.0V
RP114K211B	M 3	2.1V
RP114K221B	M 4	2.2V
RP114K231B	M 5	2.3V
RP114K241B	M 6	2.4V
RP114K251B	M 7	2.5V
RP114K261B	M 8	2.6V
RP114K271B	M 9	2.7V
RP114K281B	N 0	2.8V
RP114K291B	N 1	2.9V
RP114K301B	N 2	3.0V
RP114K311B	N 3	3.1V
RP114K321B	N 4	3.2V
RP114K331B	N 5	3.3V
RP114K341B	N 6	3.4V
RP114K351B	N 7	3.5V
RP114K361B	N 8	3.6V
RP114K121B5	N 9	1.25V
RP114K181B5	P 0	1.85V
RP114K281B5	P 1	2.85V
RP114K341B5	P 2	3.45V
RP114K101B5	P 3	1.05V
RP114K171B5	P 4	1.75V
RP114K111B5	P 5	1.15V
RP114K131B5	P 6	1.35V

RP114Kxx1D

Product Name	①②	V _{SET}
RP114K081D	Q 0	0.8V
RP114K091D	Q 1	0.9V
RP114K101D	Q 2	1.0V
RP114K111D	Q 3	1.1V
RP114K121D	Q 4	1.2V
RP114K131D	Q 5	1.3V
RP114K141D	Q 6	1.4V
RP114K151D	Q 7	1.5V
RP114K161D	Q 8	1.6V
RP114K171D	Q 9	1.7V
RP114K181D	R 0	1.8V
RP114K191D	R 1	1.9V
RP114K201D	R 2	2.0V
RP114K211D	R 3	2.1V
RP114K221D	R 4	2.2V
RP114K231D	R 5	2.3V
RP114K241D	R 6	2.4V
RP114K251D	R 7	2.5V
RP114K261D	R 8	2.6V
RP114K271D	R 9	2.7V
RP114K281D	S 0	2.8V
RP114K291D	S 1	2.9V
RP114K301D	S 2	3.0V
RP114K311D	S 3	3.1V
RP114K321D	S 4	3.2V
RP114K331D	S 5	3.3V
RP114K341D	S 6	3.4V
RP114K351D	S 7	3.5V
RP114K361D	S 8	3.6V
RP114K121D5	S 9	1.25V
RP114K181D5	T 0	1.85V
RP114K281D5	T 1	2.85V
RP114K341D5	T 2	3.45V
RP114K101D5	T 3	1.05V
RP114K171D5	T 4	1.75V
RP114K111D5	T 5	1.15V
RP114K131D5	T 6	1.35V

Power Dissipation (SC-88A)

Power Dissipation (P_D) depends on conditions of mounting on board. This specification is based on the Measurement Conditions below.

Measurement Conditions

	Standard Land Pattern
Environment	Mounting on Board (Wind Velocity=0m/s)
Board Material	Glass Cloth Epoxy Plastic (Double-sided)
Board Dimensions	40mm × 40mm × 1.6mm
Copper Ratio	Top-side: Approx. 50%, Back-side: Approx. 50%
Through-hole	φ0.5mm × 44pcs

Measurement Result

($T_a=25^{\circ}\text{C}$, $T_{j\text{max}}=125^{\circ}\text{C}$)

	Standard Land Pattern	Free Air
Power Dissipation	380mW	150mW
Thermal Resistance	$\theta_{ja}=(125-25^{\circ}\text{C})/0.38\text{W}=263^{\circ}\text{C/W}$	$\theta_{ja}=(125-25^{\circ}\text{C})/0.15\text{W}=667^{\circ}\text{C/W}$
	$\theta_{jc}=75^{\circ}\text{C/W}$	-



Measurement Board Pattern

○ IC Mount Area (Unit: mm)

Power Dissipation

Note: The above graph shows the power dissipation of the package based on $T_{j\text{max}}=125^{\circ}\text{C}$ and $T_{j\text{max}}=150^{\circ}\text{C}$.

Operating the IC within the shaded area in the graph might have an influence on its lifetime.

Operating time must be within the time limit described in the table below.

Operating Time	Estimated Years (Operating 4 hrs/ day)
13,000 hours	9 Years

RP114x

NO. EA-236-141222

Package Dimensions (SC-88A)



Mark Specification (SC-88A)

①②③④: Product Code.. **Please refer to RP114Q Mark Specification Table.**

⑤⑥: Lot Number Alphanumeric Serial Number

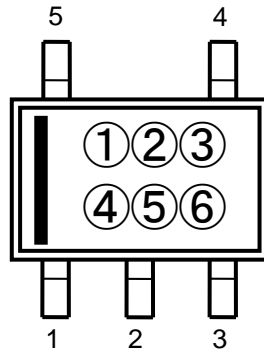

Mark Specification Table (SC-88A)

RP114Qxx2B

Product Name	①②③④	V _{SET}
RP114Q082B	A G 0 8	0.8V
RP114Q092B	A G 0 9	0.9V
RP114Q102B	A G 1 0	1.0V
RP114Q112B	A G 1 1	1.1V
RP114Q122B	A G 1 2	1.2V
RP114Q132B	A G 1 3	1.3V
RP114Q142B	A G 1 4	1.4V
RP114Q152B	A G 1 5	1.5V
RP114Q162B	A G 1 6	1.6V
RP114Q172B	A G 1 7	1.7V
RP114Q182B	A G 1 8	1.8V
RP114Q192B	A G 1 9	1.9V
RP114Q202B	A G 2 0	2.0V
RP114Q212B	A G 2 1	2.1V
RP114Q222B	A G 2 2	2.2V
RP114Q232B	A G 2 3	2.3V
RP114Q242B	A G 2 4	2.4V
RP114Q252B	A G 2 5	2.5V
RP114Q262B	A G 2 6	2.6V
RP114Q272B	A G 2 7	2.7V
RP114Q282B	A G 2 8	2.8V
RP114Q292B	A G 2 9	2.9V
RP114Q302B	A G 3 0	3.0V
RP114Q312B	A G 3 1	3.1V
RP114Q322B	A G 3 2	3.2V
RP114Q332B	A G 3 3	3.3V
RP114Q342B	A G 3 4	3.4V
RP114Q352B	A G 3 5	3.5V
RP114Q362B	A G 3 6	3.6V
RP114Q122B5	A G 3 7	1.25V
RP114Q182B5	A G 3 8	1.85V
RP114Q282B5	A G 3 9	2.85V
RP114Q342B5	A G 4 0	3.45V
RP114Q102B5	A G 4 1	1.05V

RP114Qxx2D

Product Name	①②③④	V _{SET}
RP114Q082D	A H 0 8	0.8V
RP114Q092D	A H 0 9	0.9V
RP114Q102D	A H 1 0	1.0V
RP114Q112D	A H 1 1	1.1V
RP114Q122D	A H 1 2	1.2V
RP114Q132D	A H 1 3	1.3V
RP114Q142D	A H 1 4	1.4V
RP114Q152D	A H 1 5	1.5V
RP114Q162D	A H 1 6	1.6V
RP114Q172D	A H 1 7	1.7V
RP114Q182D	A H 1 8	1.8V
RP114Q192D	A H 1 9	1.9V
RP114Q202D	A H 2 0	2.0V
RP114Q212D	A H 2 1	2.1V
RP114Q222D	A H 2 2	2.2V
RP114Q232D	A H 2 3	2.3V
RP114Q242D	A H 2 4	2.4V
RP114Q252D	A H 2 5	2.5V
RP114Q262D	A H 2 6	2.6V
RP114Q272D	A H 2 7	2.7V
RP114Q282D	A H 2 8	2.8V
RP114Q292D	A H 2 9	2.9V
RP114Q302D	A H 3 0	3.0V
RP114Q312D	A H 3 1	3.1V
RP114Q322D	A H 3 2	3.2V
RP114Q332D	A H 3 3	3.3V
RP114Q342D	A H 3 4	3.4V
RP114Q352D	A H 3 5	3.5V
RP114Q362D	A H 3 6	3.6V
RP114Q122D5	A H 3 7	1.25V
RP114Q182D5	A H 3 8	1.85V
RP114Q282D5	A H 3 9	2.85V
RP114Q342D5	A H 4 0	3.45V
RP114Q102D5	A H 4 1	1.05V

RP114x

NO. EA-236-141222

Power Dissipation (SOT-23-5)

Power Dissipation (P_D) depends on conditions of mounting on board. This specification is based on the Measurement Conditions below. (Power Dissipation (SOT-23-5) is substitution of SOT-23-6.)

Measurement Conditions

	Standard Land Pattern
Environment	Mounting on Board (Wind Velocity=0m/s)
Board Material	Glass Cloth Epoxy Plastic (Double-sided)
Board Dimensions	40mm x 40mm x 1.6mm
Copper Ratio	Top-side: Approx. 50%, Back-side: Approx. 50%
Through-holes	ϕ 0.5mm x 44pcs

Measurement Result

($T_a=25^\circ\text{C}$)

	Standard Land Pattern	Free Air
Power Dissipation	420mW ($T_{jmax}=125^\circ\text{C}$) 525mW ($T_{jmax}=150^\circ\text{C}$)	250mW ($T_{jmax}=125^\circ\text{C}$)
Thermal Resistance	$\theta_{ja}=(125-25^\circ\text{C})/0.42\text{W}=238^\circ\text{C/W}$	400 $^\circ\text{C/W}$

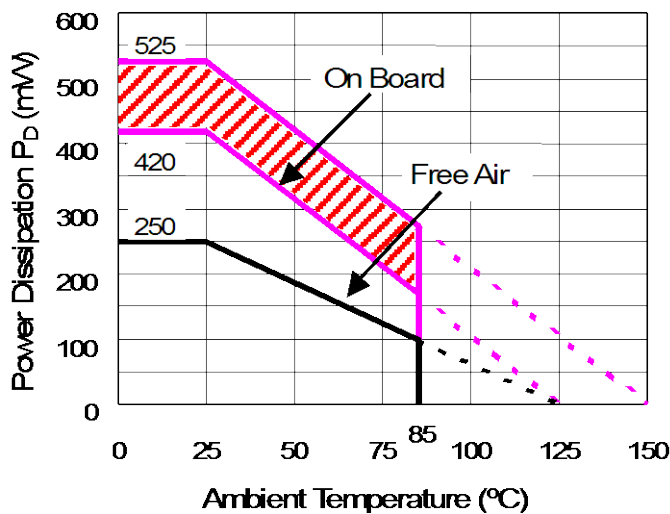

Power Dissipation

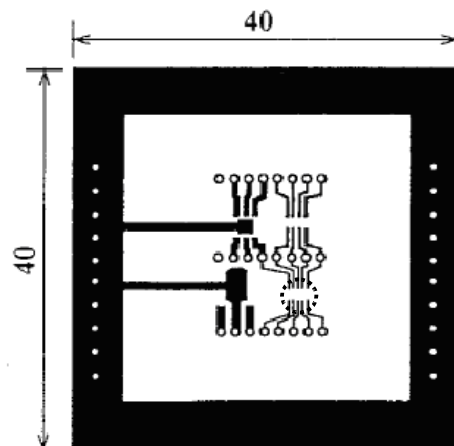

Measurement Board Pattern

○ IC Mount Area (Unit: mm)

Note: The above graph shows the power dissipation of the package based on $T_{jmax}=125^\circ\text{C}$ and $T_{jmax}=150^\circ\text{C}$.

Operating the IC within the shaded area in the graph might have an influence on its lifetime.

Operating time must be within the time limit described in the table below.

Operating Time	Estimated Years (Operating 4 hrs/ day)
13,000 hours	9 Years

Package Dimensions (SOT-23-5)

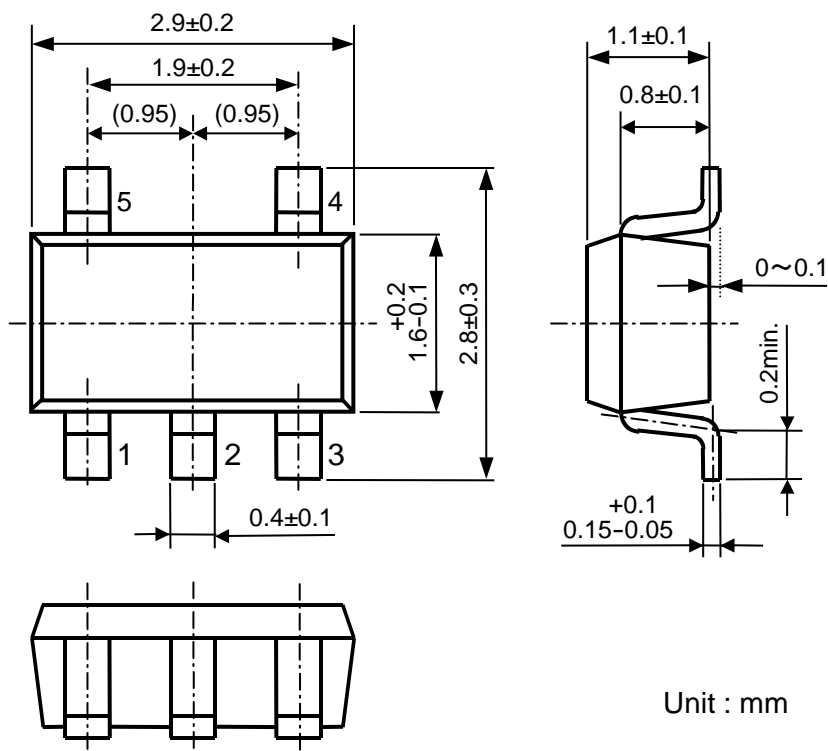

Mark Specification (SOT-23-5)

- ①②③: Product Code.....**Please refer to RP114N Mark Specification Table.**
- ④⑤: Lot Number.....Alphanumeric Serial Number



RP114xNO. EA-236-141222

Mark Specification Table (SOT-23-5)**RP114Nxx1B**

Product Name	①②③	V _{SET}
RP114N081B	Q A A	0.8V
RP114N091B	Q A B	0.9V
RP114N101B	Q A C	1.0V
RP114N111B	Q A D	1.1V
RP114N121B	Q A E	1.2V
RP114N131B	Q A F	1.3V
RP114N141B	Q A G	1.4V
RP114N151B	Q A H	1.5V
RP114N161B	Q A J	1.6V
RP114N171B	Q A K	1.7V
RP114N181B	Q A L	1.8V
RP114N191B	Q A M	1.9V
RP114N201B	Q A N	2.0V
RP114N211B	Q A P	2.1V
RP114N221B	Q A Q	2.2V
RP114N231B	Q A R	2.3V
RP114N241B	Q A S	2.4V
RP114N251B	Q A T	2.5V
RP114N261B	Q A U	2.6V
RP114N271B	Q A V	2.7V
RP114N281B	Q A W	2.8V
RP114N291B	Q A X	2.9V
RP114N301B	Q A Y	3.0V
RP114N311B	Q A Z	3.1V
RP114N321B	R A A	3.2V
RP114N331B	R A B	3.3V
RP114N341B	R A C	3.4V
RP114N351B	R A D	3.5V
RP114N361B	R A E	3.6V
RP114N121B5	R A F	1.25V
RP114N181B5	R A G	1.85V
RP114N281B5	R A H	2.85V
RP114N341B5	R A J	3.45V
RP114N101B5	R A K	1.05V

RP114Nxx1D

Product Name	①②③	V _{SET}
RP114N081D	Q B A	0.8V
RP114N091D	Q B B	0.9V
RP114N101D	Q B C	1.0V
RP114N111D	Q B D	1.1V
RP114N121D	Q B E	1.2V
RP114N131D	Q B F	1.3V
RP114N141D	Q B G	1.4V
RP114N151D	Q B H	1.5V
RP114N161D	Q B J	1.6V
RP114N171D	Q B K	1.7V
RP114N181D	Q B L	1.8V
RP114N191D	Q B M	1.9V
RP114N201D	Q B N	2.0V
RP114N211D	Q B P	2.1V
RP114N221D	Q B Q	2.2V
RP114N231D	Q B R	2.3V
RP114N241D	Q B S	2.4V
RP114N251D	Q B T	2.5V
RP114N261D	Q B U	2.6V
RP114N271D	Q B V	2.7V
RP114N281D	Q B W	2.8V
RP114N291D	Q B X	2.9V
RP114N301D	Q B Y	3.0V
RP114N311D	Q B Z	3.1V
RP114N321D	R B A	3.2V
RP114N331D	R B B	3.3V
RP114N341D	R B C	3.4V
RP114N351D	R B D	3.5V
RP114N361D	R B E	3.6V
RP114N121D5	R B F	1.25V
RP114N181D5	R B G	1.85V
RP114N281D5	R B H	2.85V
RP114N341D5	R B J	3.45V
RP114N101D5	R B K	1.05V

TYPICAL CHARACTERISTICS

Note: Typical Characteristics are intended to be used as reference data; they are not guaranteed.

1) Output Voltage vs. Output Current (C1=1.0μF, C2=1.0μF, T_{opt}=25°C)



2) Output Voltage vs. Input Voltage (C1=1.0μF, C2=1.0μF, T_{opt}=25°C)



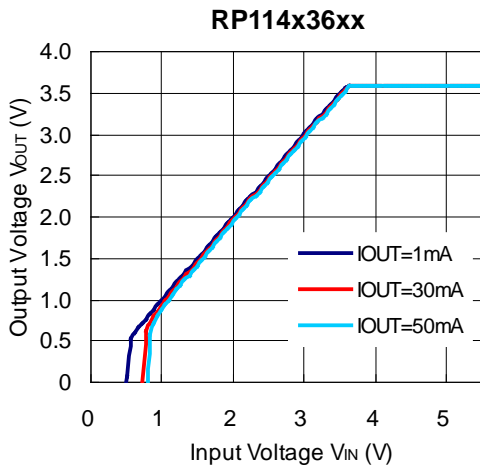

3) Supply Current vs. Input Voltage ($C1=1.0\mu F$, $C2=1.0\mu F$, $T_{opt}=25^{\circ}C$)

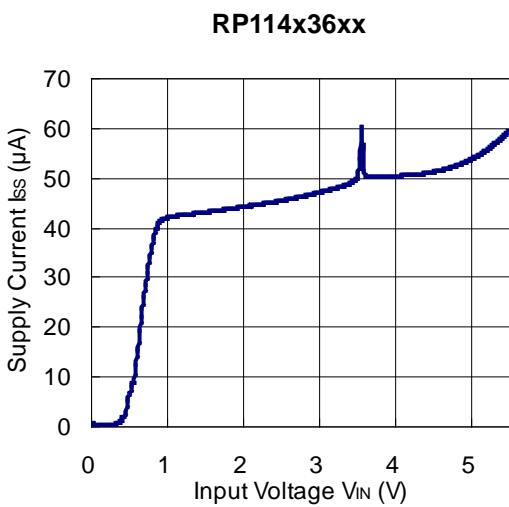
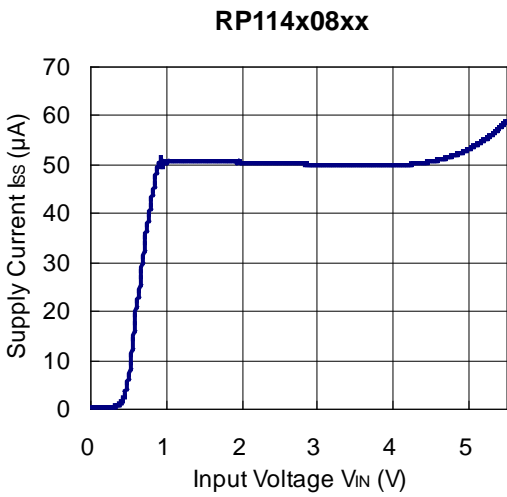

4) Output Voltage vs. Temperature ($C1=1.0\mu F$, $C2=1.0\mu F$, $I_{OUT}=1mA$)

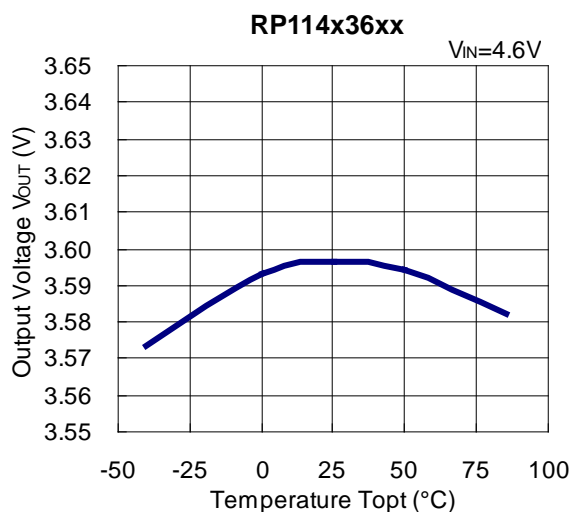

5) Supply Current vs. Temperature ($C1=1.0\mu F$, $C2=1.0\mu F$, $I_{OUT}=0mA$)



RP114x

NO. EA-236-141222

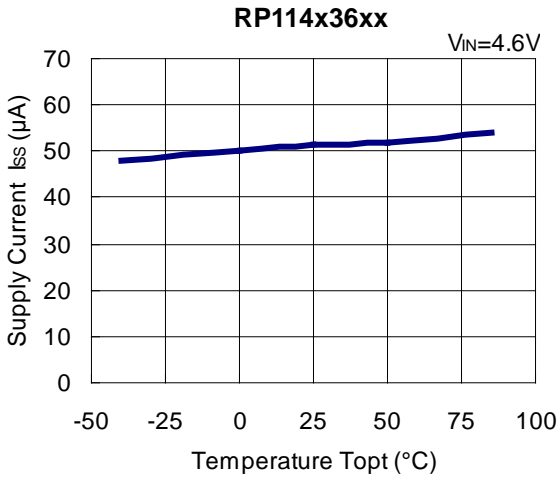

6) Dropout Voltage vs. Output Current ($C1=1.0\mu F$, $C2=1.0\mu F$)

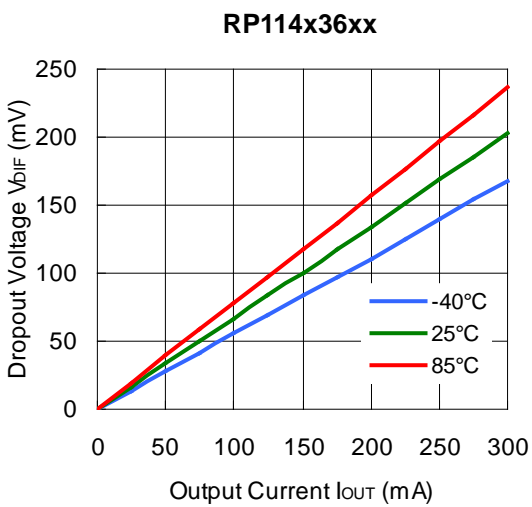
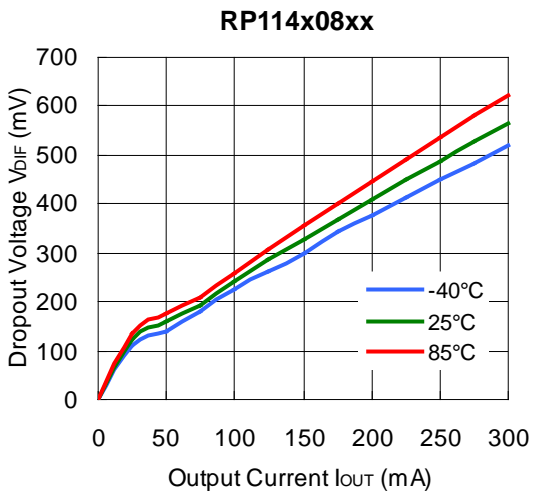

7) Dropout Voltage vs. Set Output Voltage (C1=1.0μF, C2=1.0μF, T_{opt}=25°C)



8) Dropout Voltage vs. Temperature (C1=none, C2=1.0μF)

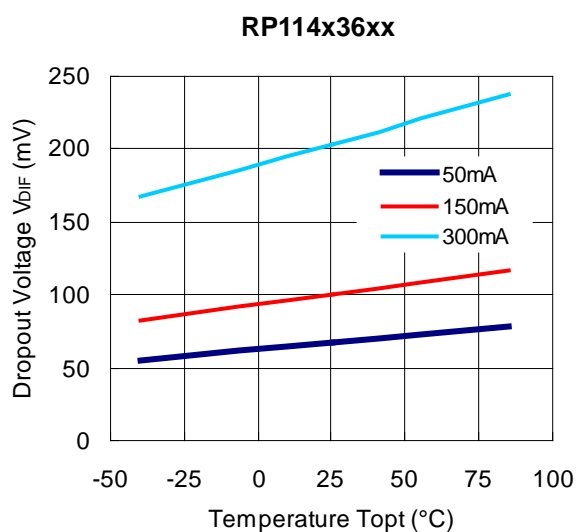
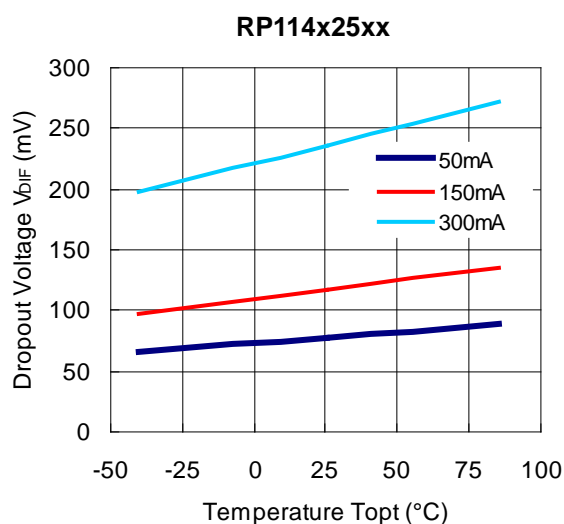
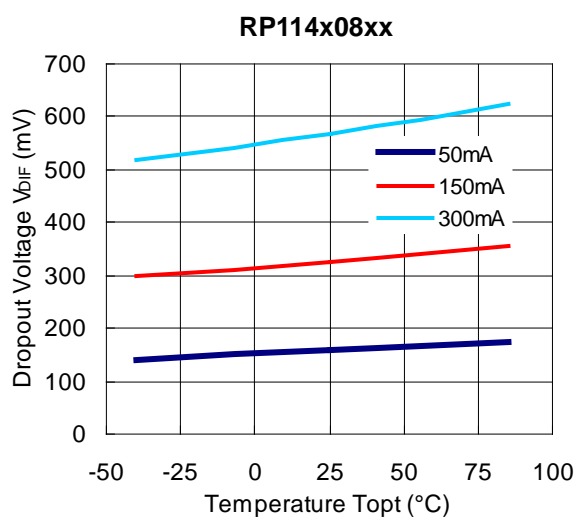

RP114x

NO. EA-236-141222

9) Ripple Rejection vs. Input Voltage (C1=none, C2=1.0μF, Ripple=0.2Vp-p, T_{opt}=25°C)

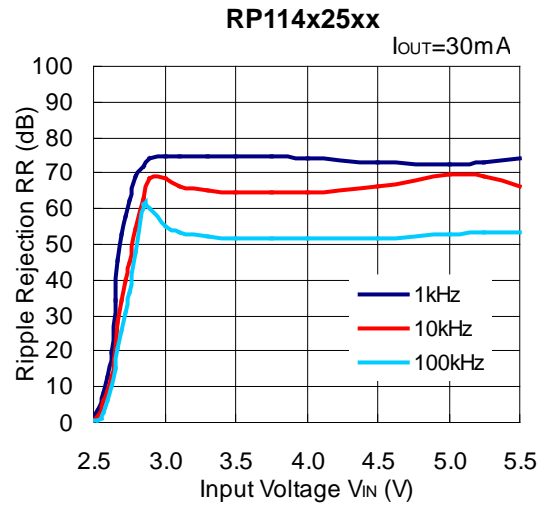

10) Ripple Rejection vs. Frequency (C1=none, C2=1.0μF, T_{opt}=25°C)

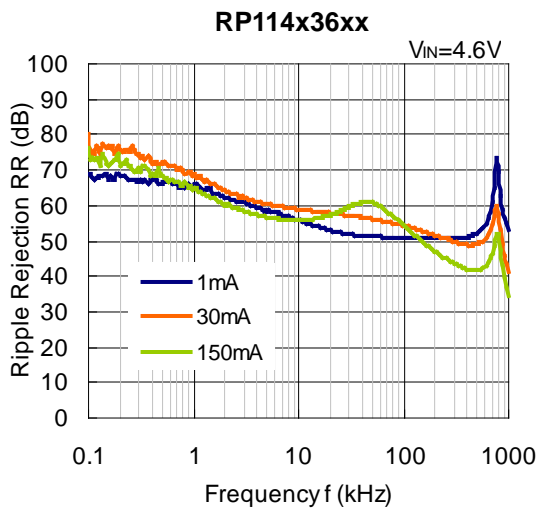

11) Input Transient Response ($I_{OUT}=30mA$, $t_r=t_f=5\mu s$, $T_{opt}=25^\circ C$)

RP114x08xx

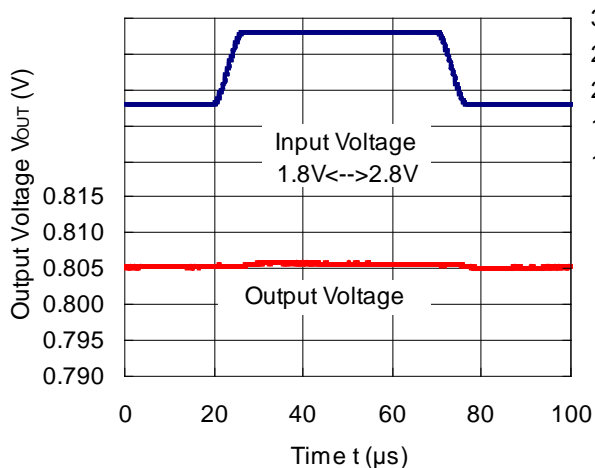

RP114x25xx



RP114x36xx



12) Load Transient Response ($C_1=1.0\mu F$, $C_2=1.0\mu F$, $t_r=t_f=0.5\mu s$, $T_{opt}=25^\circ C$)

RP114x08xx



RP114x25xx

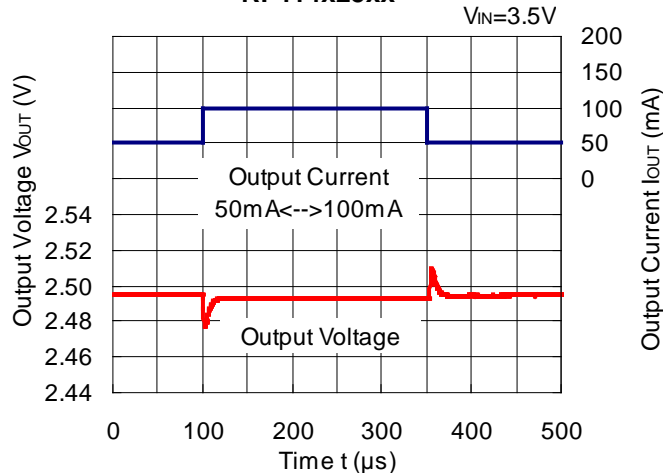

RP114x

NO. EA-236-141222



13) Turn On Speed with CE pin ($C1=1.0\mu\text{F}$, $C2=1.0\mu\text{F}$, $T_{\text{opt}}=25^\circ\text{C}$)



14) Turn Off Speed with CE pin (B version) ($C1=1.0\mu\text{F}$, $C2=1.0\mu\text{F}$, $T_{\text{opt}}=25^\circ\text{C}$)



RP114x36xB

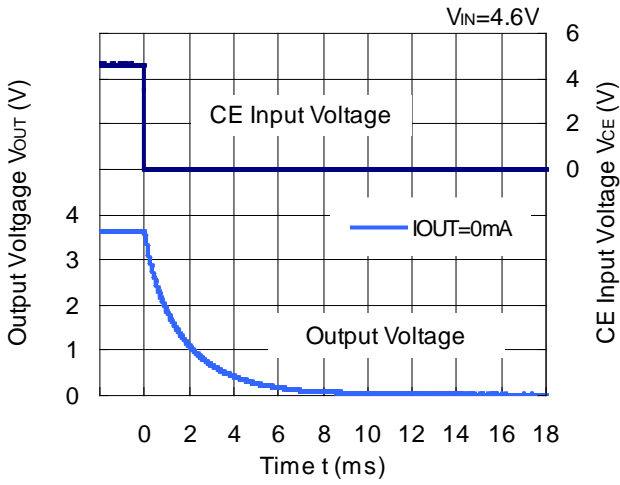

15) Turn Off Speed with CE pin (D version) (C1=1.0μF, C2=1.0μF, T_{opt}=25°C)

RP114x08xD

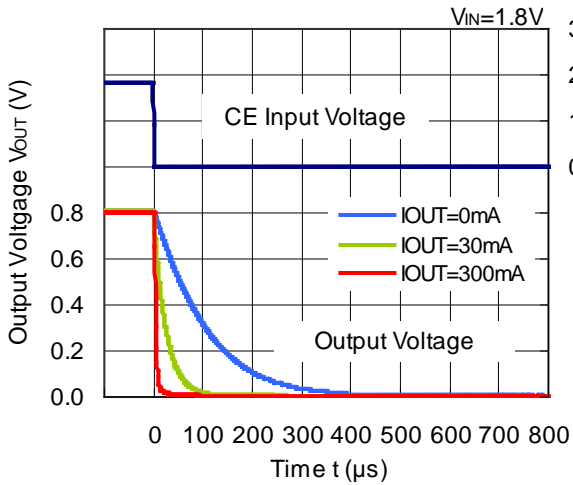

RP114x25xD

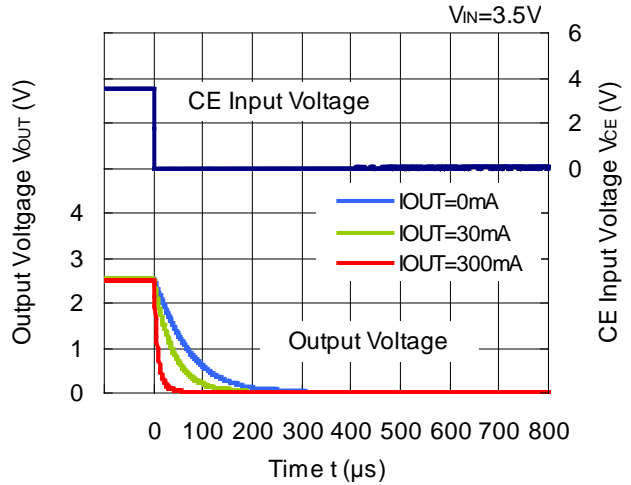

RP114x36xD

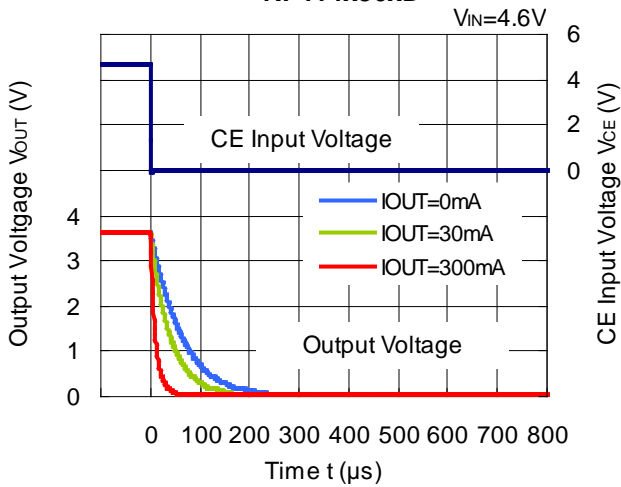

ESR vs. Output Current

When using these ICs, consider the following points:

The relations between I_{OUT} (Output Current) and ESR of an output capacitor are shown below.

The conditions when the white noise level is under $40\mu\text{V}$ (Avg.) are marked as the hatched area in the graph.

Measurement conditions

Frequency Band: 10Hz to 2MHz

Temperature : -40°C to 85°C

C1, C2 : $1.0\mu\text{F}$

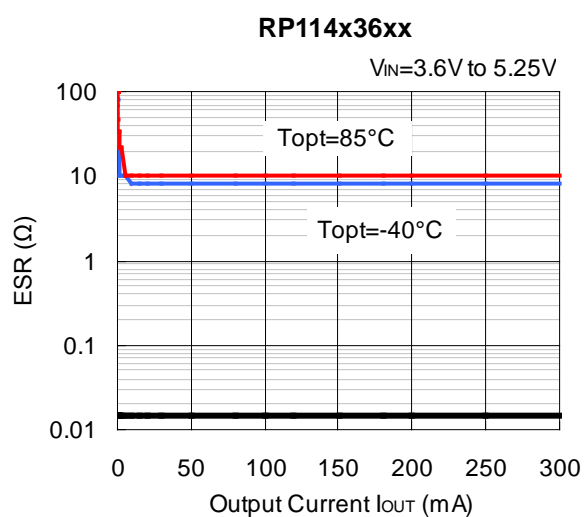
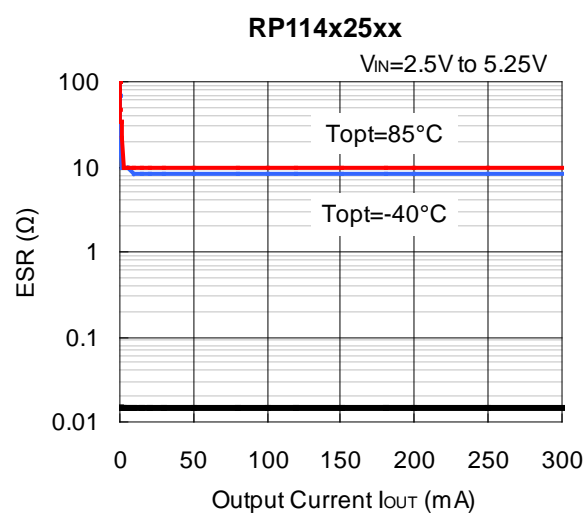
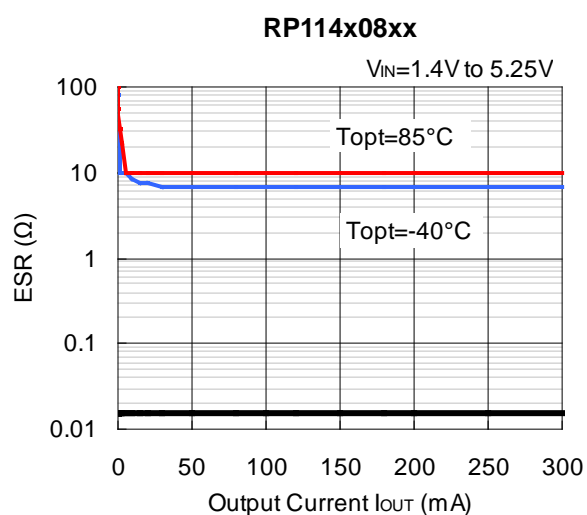



1. The products and the product specifications described in this document are subject to change or discontinuation of production without notice for reasons such as improvement. Therefore, before deciding to use the products, please refer to Ricoh sales representatives for the latest information thereon.
2. The materials in this document may not be copied or otherwise reproduced in whole or in part without prior written consent of Ricoh.
3. Please be sure to take any necessary formalities under relevant laws or regulations before exporting or otherwise taking out of your country the products or the technical information described herein.
4. The technical information described in this document shows typical characteristics of and example application circuits for the products. The release of such information is not to be construed as a warranty of or a grant of license under Ricoh's or any third party's intellectual property rights or any other rights.
5. The products listed in this document are intended and designed for use as general electronic components in standard applications (office equipment, telecommunication equipment, measuring instruments, consumer electronic products, amusement equipment etc.). Those customers intending to use a product in an application requiring extreme quality and reliability, for example, in a highly specific application where the failure or misoperation of the product could result in human injury or death (aircraft, spacevehicle, nuclear reactor control system, traffic control system, automotive and transportation equipment, combustion equipment, safety devices, life support system etc.) should first contact us.
6. We are making our continuous effort to improve the quality and reliability of our products, but semiconductor products are likely to fail with certain probability. In order to prevent any injury to persons or damages to property resulting from such failure, customers should be careful enough to incorporate safety measures in their design, such as redundancy feature, fire containment feature and fail-safe feature. We do not assume any liability or responsibility for any loss or damage arising from misuse or inappropriate use of the products.
7. Anti-radiation design is not implemented in the products described in this document.
8. Please contact Ricoh sales representatives should you have any questions or comments concerning the products or the technical information.



Ricoh is committed to reducing the environmental loading materials in electrical devices with a view to contributing to the protection of human health and the environment.

Ricoh has been providing RoHS compliant products since April 1, 2006 and Halogen-free products since April 1, 2012.

RICOH RICOH ELECTRONIC DEVICES CO., LTD.

<http://www.e-devices.ricoh.co.jp/en/>

Sales & Support Offices

RICOH ELECTRONIC DEVICES CO., LTD.

Higashi-Shinagawa Office (International Sales)
3-32-3, Higashi-Shinagawa, Shinagawa-ku, Tokyo 140-8655, Japan
Phone: +81-3-5479-2857 Fax: +81-3-5479-0502

RICOH EUROPE (NETHERLANDS) B.V.

Semiconductor Support Centre
Prof. W.H. Keesomlaan 1, 1183 DJ Amstelveen, The Netherlands
Phone: +31-20-5474-309

RICOH ELECTRONIC DEVICES KOREA CO., LTD.

3F, Haesung Bldg. 504, Teheran-ro, Gangnam-gu, Seoul, 135-725, Korea
Phone: +82-2-2135-5700 Fax: +82-2-2051-5713

RICOH ELECTRONIC DEVICES SHANGHAI CO., LTD.

Room 403, No.2 Building, No.690 Bilbo Road, Pu Dong New District, Shanghai 201203,
People's Republic of China
Phone: +86-21-5027-3200 Fax: +86-21-5027-3299

RICOH ELECTRONIC DEVICES CO., LTD.

Taipei office
Room 109, 10F-1, No.51, Hengyang Rd., Taipei City, Taiwan (R.O.C.)
Phone: +886-2-2313-1621/1622 Fax: +886-2-2313-1623

Mouser Electronics

Authorized Distributor

Click to View Pricing, Inventory, Delivery & Lifecycle Information:

Ricoh Electronics:

[RP114K281D-TR](#) [RP114N301D-TR-FE](#) [RP114N181D-TR-FE](#) [RP114K181D-TR](#) [RP114K301D-TR](#) [RP114N101D-TR-FE](#) [RP114N281D-TR-FE](#) [RP114N331D-TR-FE](#) [RP114N151D-TR-FE](#) [RP114K331D-TR](#) [RP114K151D-TR](#) [RP114N251D-TR-FE](#) [RP114N121D-TR-FE](#) [RP114K121D-TR](#) [RP114N181B-TR-FE](#) [RP114K251D-TR](#)



Компания «ЭлектроПласт» предлагает заключение долгосрочных отношений при поставках импортных электронных компонентов на взаимовыгодных условиях!

Наши преимущества:

- Оперативные поставки широкого спектра электронных компонентов отечественного и импортного производства напрямую от производителей и с крупнейших мировых складов;
- Поставка более 17-ти миллионов наименований электронных компонентов;
- Поставка сложных, дефицитных, либо снятых с производства позиций;
- Оперативные сроки поставки под заказ (от 5 рабочих дней);
- Экспресс доставка в любую точку России;
- Техническая поддержка проекта, помощь в подборе аналогов, поставка прототипов;
- Система менеджмента качества сертифицирована по Международному стандарту ISO 9001;
- Лицензия ФСБ на осуществление работ с использованием сведений, составляющих государственную тайну;
- Поставка специализированных компонентов (Xilinx, Altera, Analog Devices, Intersil, Interpoint, Microsemi, Aeroflex, Peregrine, Syfer, Eurofarad, Texas Instrument, Miteq, Cobham, E2V, MA-COM, Hittite, Mini-Circuits, General Dynamics и др.);

Помимо этого, одним из направлений компании «ЭлектроПласт» является направление «Источники питания». Мы предлагаем Вам помощь Конструкторского отдела:

- Подбор оптимального решения, техническое обоснование при выборе компонента;
- Подбор аналогов;
- Консультации по применению компонента;
- Поставка образцов и прототипов;
- Техническая поддержка проекта;
- Защита от снятия компонента с производства.



Как с нами связаться

Телефон: 8 (812) 309 58 32 (многоканальный)

Факс: 8 (812) 320-02-42

Электронная почта: org@eplast1.ru

Адрес: 198099, г. Санкт-Петербург, ул. Калинина, дом 2, корпус 4, литера А.