

POWER RELAY

1 POLE - 20A Heavy Load

FTR-K3 Series

RoHS compliant

■ FEATURES

- SPST 20A and #250 tab terminal type is also available
- Low coil power (780mW)
- Cadmium free contacts
- SAFETY STANDARDS
UL, CSA, VDE, CQC approved
- RoHS Compliant since production



■ ORDERING INFORMATION

[Example] FTR-K3 J B 012 W - ()
 (a) (b) (c) (d) (e) (f)

(a)	Series Name	FTR-K3: FTR-K3 Series			
(b)	Contact Arrangement	A	: 1 form A (SPST-NO) (PCB terminal)		
		J	: 1 form A (SPST-NO) (Tab terminal)		
(c)	Coil Type / Enclosure	B	: Standard (780 mW)		
(d)	Nominal Voltage	005	006	009	012
		: 5 VDC,	: 6VDC,	: 9VDC	: 12VDC
		018	024:	048	
		: 18 VDC	24VDC,	: 48VDC	
(e)	Contact Material / TV type	W	: Silver alloy		
(f)	Special Designation	:			

Actual marking does not carry the type name : "FTR"

E.g.: Ordering code: FTR-K3AB012W

Actual marking: K3AB012W

FTR-K3 SERIES

■ PART NUMBERS

400mW type

Ordering Part Number	Series	Contact	Coil Power	Coil Voltage	Contact Material
FTR-K3AB005W	FTR-K3	A: 1 form A PCB terminal	B: 780 mW	5	W: Silver alloy
FTR-K3AB006W				6	
FTR-K3AB009W				9	
FTR-K3AB012W				12	
FTR-K3AB018W				18	
FTR-K3AB024W				24	
FTR-K3AB048W				48	
FTR-K3JB005W		J: 1 form A Tab terminal		5	
FTR-K3JB006W				6	
FTR-K3JB009W				9	
FTR-K3JB012W				12	
FTR-K3JB018W				18	
FTR-K3JB024W				24	
FTR-K3JB048W				48	

■ COIL DATA CHART

Coil Voltage	Nominal Voltage (VDC)	Coil Resistance (±10%)	Must Operate Voltage*2	Must Release Voltage*2	Nominal Power (mW)
005	5	32 Ω	3.5 VDC	0.5 VDC	780
006	6	46 Ω	4.2 VDC	0.6 VDC	
009	9	105 Ω	6.3 VDC	0.9 VDC	
012	12	185 Ω	8.4 VDC	1.2 VDC	
018	18	415 Ω	12.6 VDC	1.8 VDC	
024	24	740 Ω	16.8 VDC	2.4 VDC	
048	48	2,955 Ω	33.6 VDC	4.8 VDC	

Note: All values in the table are measured at 20°C.

*1: No contact current at 20°C

*2: Specified values are subject to pulse wave voltage

FTR-K3 SERIES

■ SPECIFICATIONS

Item		FTR-K3	
Contact	Arrangement		1 form A
	Material		Silver alloy
	Configuration		Single
	Resistance (initial)		Maximum 100 mΩ at 1 A, 6 VDC
	Rating		20 A, 250 VAC (resistive)
	Maximum Carrying Current*1		25A
	Maximum Switching Current		25A
	Maximum Switching Rating		6,250VA
	Maximum Switching Voltage		250 VAC
	Maximum Switching Load*2		100 mA 5VDC
Coil	Nominal Power (at 20°C)		780mW
	Operate Power (at 20°C)		380 mW
	Operating Temperature		-40°C to +60°C (no frost)
Time Value	Operate (without diode)		Maximum 20ms (at nominal voltage, no bounce)
	Release (without diode)		Maximum 10ms (at nominal voltage, no bounce)
Life	Mechanical		20 x 10 ⁶ operations minimum
	Electrical	Resistive	100 x 10 ³ operations min.
		Motor	200 x 10 ³ operations min.
		Inverter	30 x 10 ³ operations min.
Other	Vibration Resistance	Misoperation	10 to 55 Hz, at double amplitude of 0.7 mm
		Endurance	10-55Hz, at double amplitude of 1.5 mm
	Shock Resistance	Misoperation	Min. 100m/s ² (11±1ms)
		Endurance	Min. 1,000m/s ² (6±1ms)
	Weight		Approximately 25g

*1 Need to consider the head from PCB when max. current is more than 10A.

*2 Minimum switching loads mentioned above are reference values. Please perform the confirmation test with the actual load before production since reference values may vary according to switching frequencies, environmental conditions and expected reliability levels.

FTR-K3 SERIES

■ INSULATION

Item	FTR-K1	Note
Resistance (initial)	Minimum 1,000 MΩ 1 min.	at 500 VDC
Dielectric Strength	open contacts	1,000 VAC (50/60 Hz) 1 min.
	coil and contacts	5,000 VAC (50/60 Hz) 1 min.
Surge Voltage (coil and contact)	8,500 V	1.2 x 50μs standard wave

■ SAFETY STANDARDS

Type	Compliance	Contact rating
		FTR-K3
UL	UL 508	Flammability: UL 94-V0 (plastics)
	E63614	20A, 277 VAC (resistive) 1 HP, 125VAC
CSA	C22.2 No. 14 LR 40304	2 HP, 277VAC, 100,000 ops.
VDE	0435	
CQC	04001009179	

Complies with NEMKO, DEMKO, FIMKO

■ CHARACTERISTIC DATA

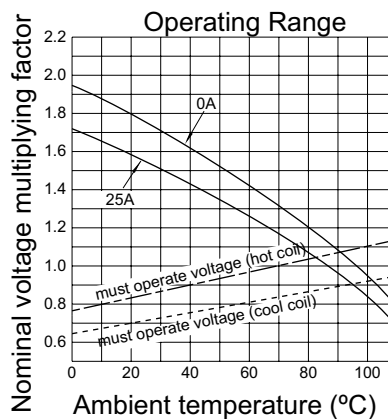
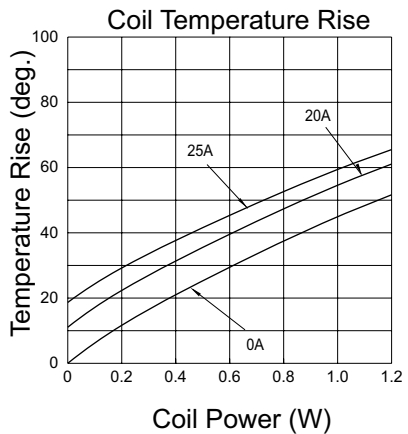

FTR-K3 SERIES

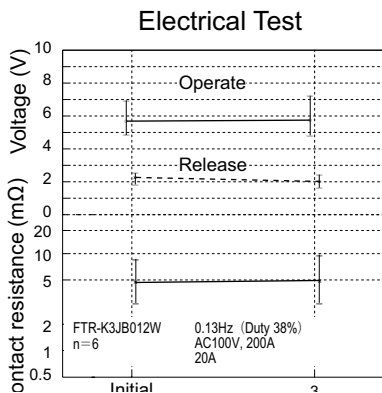
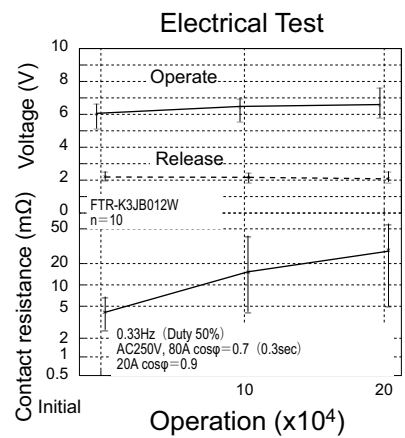
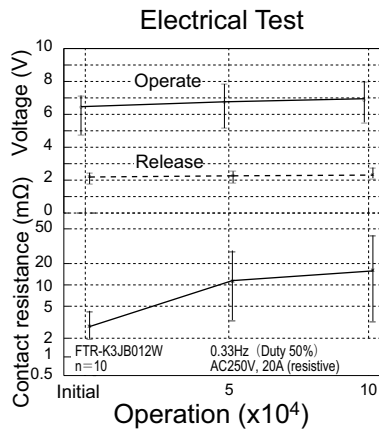
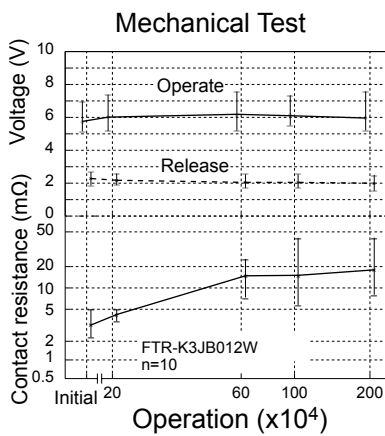
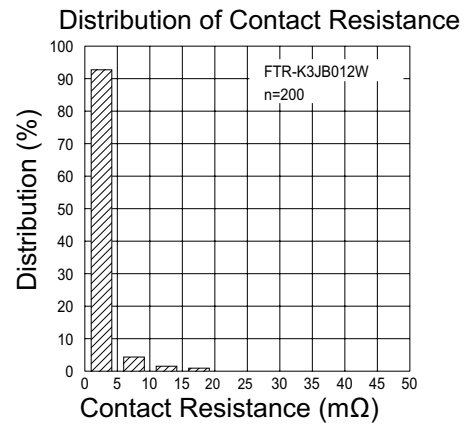
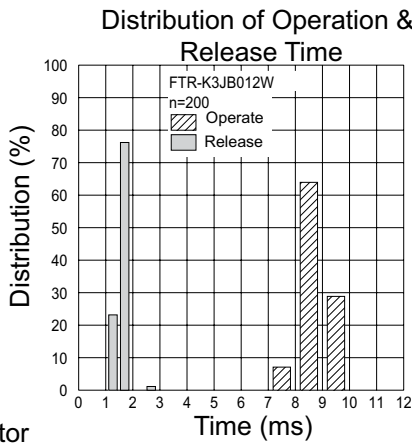
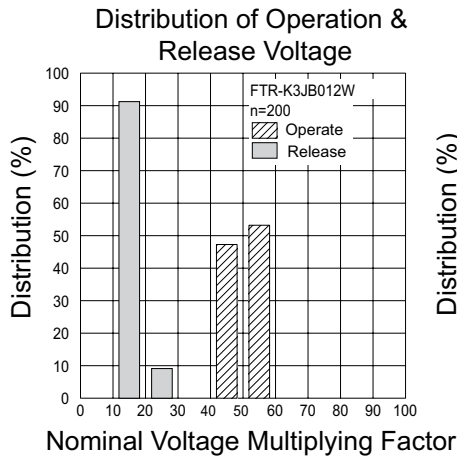
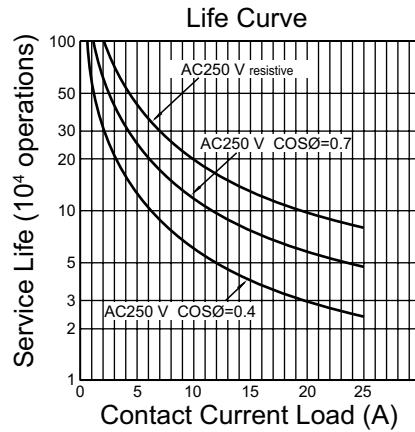
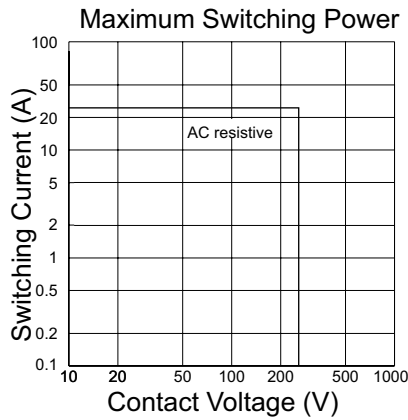

RoHS Compliance and Lead Free Relay Information

1. General Information

- Relays produced after the specific date code that is indicated on each data sheet are lead-free now. All of our signal and power relays are lead-free. Please refer to Lead-Free Status Info. (<http://www.fujitsu.com/us/downloads/MICRO/fcai/relays/lead-free-letter.pdf>)
- Lead free solder paste currently used in relays is Sn-3.0Ag-0.5Cu.
- All signal and power relays also comply with RoHS. Please refer to individual data sheets. Relays that are RoHS compliant do not contain the 5 hazardous materials that are restricted by RoHS directive (lead, mercury, chromium IV, PBB, PBDE).
- It has been verified that using lead-free relays in lead assembly process will not cause any problems (compatible).
- "LF" is marked on each outer and inner carton. (No marking on individual relays).
- To avoid leaded relays (for lead-free sample, etc.) please consult with area sales office.
- We will ship leaded relays as long as the leaded relay inventory exists.

Note: Cadmium was exempted from RoHS on October 21, 2005. (Amendment to Directive 2002/95/EC)

2. Recommended Lead Free Solder Profile

- Recommended solder paste Sn-3.0Ag-0.5Cu.

Reflow Solder condition

Flow Solder condition:

Pre-heating: maximum 120°C
Soldering: dip within 5 sec. at
260°C solder bath

Solder by Soldering Iron:

Soldering Iron
Temperature: maximum 360°C
Duration: maximum 3 sec.

We highly recommend that you confirm your actual solder conditions

3. Moisture Sensitivity

- Moisture Sensitivity Level standard is not applicable to electromechanical relays.

4. Tin Whisker

- Dipped SnAgCu solder is known as low risk tin whisker. No considerable length whisker was found by our in house test.

Fujitsu Components International Headquarter Offices

Japan

Fujitsu Component Limited
Gotanda-Chuo Building
3-5, Higashigotanda 2-chome, Shinagawa-ku
Tokyo 141, Japan
Tel: (81-3) 5449-7010
Fax: (81-3) 5449-2626
Email: promothq@ft.ed.fujitsu.com
Web: www.fcl.fujitsu.com

North and South America

Fujitsu Components America, Inc.
250 E. Caribbean Drive
Sunnyvale, CA 94089 U.S.A.
Tel: (1-408) 745-4900
Fax: (1-408) 745-4970
Email: components@us.fujitsu.com
Web: <http://www.fujitsu.com/us/services/edevices/components/>

Europe

Fujitsu Components Europe B.V.
Diamantlaan 25
2132 WV Hoofddorp
Netherlands
Tel: (31-23) 5560910
Fax: (31-23) 5560950
Email: info@fceu.fujitsu.com
Web: emea.fujitsu.com/components/

Asia Pacific

Fujitsu Components Asia Ltd.
102E Pasir Panjang Road
#01-01 Citilink Warehouse Complex
Singapore 118529
Tel: (65) 6375-8560
Fax: (65) 6273-3021
Email: fcal@fcal.fujitsu.com
Web: <http://www.fujitsu.com/sg/services/micro/components/>

©2010 Fujitsu Components America, Inc. All rights reserved. All trademarks or registered trademarks are the property of their respective owners.

Fujitsu Components America or its affiliates do not warrant that the content of datasheet is error free. In a continuing effort to improve our products Fujitsu Components America, Inc. or its affiliates reserve the right to change specifications/datasheets without prior notice.
Rev. April 16, 2010.



Компания «ЭлектроПласт» предлагает заключение долгосрочных отношений при поставках импортных электронных компонентов на взаимовыгодных условиях!

Наши преимущества:

- Оперативные поставки широкого спектра электронных компонентов отечественного и импортного производства напрямую от производителей и с крупнейших мировых складов;
- Поставка более 17-ти миллионов наименований электронных компонентов;
- Поставка сложных, дефицитных, либо снятых с производства позиций;
- Оперативные сроки поставки под заказ (от 5 рабочих дней);
- Экспресс доставка в любую точку России;
- Техническая поддержка проекта, помощь в подборе аналогов, поставка прототипов;
- Система менеджмента качества сертифицирована по Международному стандарту ISO 9001;
- Лицензия ФСБ на осуществление работ с использованием сведений, составляющих государственную тайну;
- Поставка специализированных компонентов (Xilinx, Altera, Analog Devices, Intersil, Interpoint, Microsemi, Aeroflex, Peregrine, Syfer, Eurofarad, Texas Instrument, Miteq, Cobham, E2V, MA-COM, Hittite, Mini-Circuits, General Dynamics и др.);

Помимо этого, одним из направлений компании «ЭлектроПласт» является направление «Источники питания». Мы предлагаем Вам помощь Конструкторского отдела:

- Подбор оптимального решения, техническое обоснование при выборе компонента;
- Подбор аналогов;
- Консультации по применению компонента;
- Поставка образцов и прототипов;
- Техническая поддержка проекта;
- Защита от снятия компонента с производства.



Как с нами связаться

Телефон: 8 (812) 309 58 32 (многоканальный)

Факс: 8 (812) 320-02-42

Электронная почта: org@eplast1.ru

Адрес: 198099, г. Санкт-Петербург, ул. Калинина, дом 2, корпус 4, литера А.