

**HF RoHS Fixed Voltage Series - DO-214**



**Agency Approvals**

| Agency | Agency File Number |
|--------|--------------------|
|        | E133083            |

**Pinout Designation**



**Schematic Symbol**



**Description**

Fixed Voltage Series DO-214 are uni-directional SIDACTor® devices designed to protect SLICs (Subscriber Line Interface Circuit) from damaging overvoltage transients.

The series provides single line protection using a fixed voltage switching device for negative surges. All positive surges are routed through an internal diode to a ground reference.

**Features and Benefits**

- Low voltage overshoot
- Low on-state voltage
- Does not degrade with use
- Fails short circuit when surged in excess of ratings
- Integrated diode for positive voltage surges

**Applicable Global Standards**

- TIA-968-A
- TIA-968-B
- ITU K.20/21 Enhanced Level
- ITU K.20/21 Basic Level
- GR 1089 Inter-building\*
- GR 1089 Intra-building\*
- IEC 61000-4-5
- YD/T 1082
- YD/T 993
- YD/T 950

\*A-rated parts require series resistance

**Electrical Characteristics**

| Part Number | Marking | $V_{DRM}$          | $V_S$           | $I_H$  | $I_S$  | $I_T$ | $V_T$            | $V_F$ | Capacitance @ 1MHz, -2V bias |        |
|-------------|---------|--------------------|-----------------|--------|--------|-------|------------------|-------|------------------------------|--------|
|             |         | @ $I_{DRM}=5\mu A$ | @ 100V/ $\mu s$ |        |        |       | @ $I_T=2.2$ Amps |       | pF                           |        |
|             |         | V min              | V max           | mA min | mA max | A max | V max            |       | V max                        | pF min |
| P0641SALRP  | P61A    | 58                 | 77              | 120    | 800    | 2.2   | 4                | 5     | 50                           | 90     |
| P0721SALRP  | P71A    | 65                 | 88              | 120    | 800    | 2.2   | 4                | 5     | 45                           | 85     |
| P0901SALRP  | P91A    | 75                 | 98              | 120    | 800    | 2.2   | 4                | 5     | 45                           | 80     |
| P1101SALRP  | P01A    | 95                 | 130             | 120    | 800    | 2.2   | 4                | 5     | 40                           | 70     |
| P1301SALRP  | P131A   | 120                | 160             | 120    | 800    | 2.2   | 4                | 5     | 40                           | 70     |
| P1701SALRP  | P17A    | 160                | 200             | 120    | 800    | 2.2   | 4                | 5     | 30                           | 55     |
| P0641SCLRP  | P61C    | 58                 | 77              | 120    | 800    | 2.2   | 4                | 5     | 65                           | 200    |
| P0721SCLRP  | P71C    | 65                 | 88              | 120    | 800    | 2.2   | 4                | 5     | 60                           | 190    |
| P0901SCLRP  | P91C    | 75                 | 98              | 120    | 800    | 2.2   | 4                | 5     | 60                           | 180    |
| P1101SCLRP  | P01C    | 95                 | 130             | 120    | 800    | 2.2   | 4                | 5     | 50                           | 160    |
| P1301SCLRP  | P131C   | 120                | 160             | 120    | 800    | 2.2   | 4                | 5     | 50                           | 160    |
| P1701SCLRP  | P17C    | 160                | 200             | 120    | 800    | 2.2   | 4                | 5     | 40                           | 130    |

Notes:  
- Absolute maximum ratings measured at  $T_A = 25^\circ C$  (unless otherwise noted).  
- Devices are uni-directional

**Surge Ratings**

| Series | $I_{PP}$                                     |  |  |  |  |  |  |  |   | $I_{TSM}$<br>50/60 Hz | di/dt |
|--------|--|--|--|--|--|--|--|--|---|-----------------------|-------|
|        | 0.2x310 <sup>1</sup><br>0.5x700 <sup>2</sup> | 2x10 <sup>1</sup><br>2x10 <sup>2</sup> | 8x20 <sup>1</sup><br>1.2x50 <sup>2</sup> | 10x160 <sup>1</sup><br>10x160 <sup>2</sup> | 10x560 <sup>1</sup><br>10x560 <sup>2</sup> | 5x320 <sup>1</sup><br>9x720 <sup>2</sup> | 10x360 <sup>1</sup><br>10x360 <sup>2</sup> | 10x1000 <sup>1</sup><br>10x1000 <sup>2</sup> | 5x310 <sup>1</sup><br>10x700 <sup>2</sup> |                       |       |
|        | A min  | A min                                  | A min                                    | A min                                      | A min                                      | A min                                    | A min                                      | A min  | A min                                     |                       |       |
| A      | 20   | 150                                    | 150                                      | 90   | 50   | 75                                       | 75   | 45   | 75  | 20                    | 500   |
| C      | 50   | 500                                    | 400                                      | 200  | 150  | 200                                      | 175  | 100  | 200                                       | 30                    | 500   |

Notes:

- 1 Current waveform in  $\mu$ s
- 2 Voltage waveform in  $\mu$ s
- Peak pulse current rating ( $I_{pp}$ ) is repetitive and guaranteed for the life of the product.
- $I_{pp}$  ratings applicable over temperature range of -40°C to +85°C
- The device must initially be in thermal equilibrium with -40°C  $\leq T_J \leq$  +150°C

**Thermal Considerations**

| Package   | Symbol          | Parameter                               | Value       | Unit |
|---|-----------------|---|-------------|------|
| DO-214AA<br> | $T_J$           | Operating Junction Temperature Range    | -40 to +150 | °C   |
|   | $T_S$           | Storage Temperature Range               | -65 to +150 | °C   |
|   | $R_{\theta JA}$ | Thermal Resistance: Junction to Ambient | 90          | °C/W |

**V-I Characteristics**



**$t_r \times t_d$  Pulse Waveform**



**Normalized  $V_S$  Change vs. Junction Temperature**



**Normalized DC Holding Current vs. Case Temperature**



**Soldering Parameters**

|  |                                   |                               |
|--|-----------------------------------|-------------------------------|
| Reflow Condition                                       |                                   | Pb-Free assembly (see Fig. 1) |
| Pre Heat   | -Temperature Min ( $T_{s(min)}$ ) | +150°C                        |
|  | -Temperature Max ( $T_{s(max)}$ ) | +200°C                        |
|  | -Time (Min to Max) ( $t_s$ )      | 60-180 secs.                  |
| Average ramp up rate (Liquidus Temp ( $T_L$ ) to peak) |                                   | 3°C/sec. Max.                 |
| $T_{s(max)}$ to $T_L$ - Ramp-up Rate                   |                                   | 3°C/sec. Max.                 |
| Reflow   | -Temperature ( $T_L$ ) (Liquidus) | +217°C                        |
|  | -Temperature ( $t_L$ )            | 60-150 secs.                  |
| Peak Temp ( $T_p$ )                                    |                                   | +260(+0/-5)°C                 |
| Time within 5°C of actual Peak Temp ( $t_p$ )          |                                   | 30 secs. Max.                 |
| Ramp-down Rate   |                                   | 6°C/sec. Max.                 |
| Time 25°C to Peak Temp ( $T_p$ )                       |                                   | 8 min. Max.                   |
| Do not exceed  |                                   | +260°C                        |



**Physical Specifications**

|                        |   |
|------------------------|---|
| <b>Lead Material</b>   | Copper Alloy  |
| <b>Terminal Finish</b> | 100% Matte-Tin Plated   |
| <b>Body Material</b>   | UL recognized epoxy meeting flammability classification 94V-0 |

**Environmental Specifications**

|   |   |
|---|---|
| <b>High Temp Voltage Blocking</b>       | 80% Rated $V_{DRM}$ ( $V_{AC}$ Peak) +125°C or +150°C, 504 or 1008 hrs. MIL-STD-750 (Method 1040) JEDEC, JESD22-A-101 |
| <b>Temp Cycling</b>                     | -65°C to +150°C, 15 min. dwell, 10 up to 100 cycles. MIL-STD-750 (Method 1051) EIA/JEDEC, JESD22-A-104                |
| <b>Biased Temp &amp; Humidity</b>       | 52 $V_{DC}$ (+85°C) 85%RH, 504 up to 1008 hrs. EIA/JEDEC, JESD22-A-101  |
| <b>High Temp Storage</b>                | +150°C 1008 hrs. MIL-STD-750 (Method 1031) JEDEC, JESD22-A-101  |
| <b>Low Temp Storage</b>                 | -65°C, 1008 hrs.  |
| <b>Thermal Shock</b>                    | 0°C to +100°C, 5 min. dwell, 10 sec. transfer, 10 cycles. MIL-STD-750 (Method 1056) JEDEC, JESD22-A-106               |
| <b>Autoclave (Pressure Cooker Test)</b> | +121°C, 100%RH, 2atm, 24 up to 168 hrs. EIA/JEDEC, JESD22-A-102   |
| <b>Resistance to Solder Heat</b>        | +260°C, 30 secs. MIL-STD-750 (Method 2031)  |
| <b>Moisture Sensitivity Level</b>       | 85%RH, +85°C, 168 hrs., 3 reflow cycles (+260°C Peak). JEDEC-J-STD-020, Level 1                                       |

**Part Numbering**



**Part Marking**

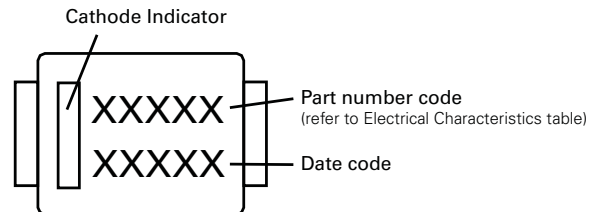

**Dimensions – DO-214AA**



| Dimensions | Inches |       | Millimeters |      |
|------------|--------|-------|-------------|------|
|            | Min    | Max   | Min         | Max  |
| A          | 0.130  | 0.156 | 3.30        | 3.95 |
| B          | 0.201  | 0.220 | 5.10        | 5.60 |
| C          | 0.077  | 0.087 | 1.95        | 2.20 |
| D          | 0.159  | 0.181 | 4.05        | 4.60 |
| E          | 0.030  | 0.063 | 0.75        | 1.60 |
| F          | 0.075  | 0.096 | 1.90        | 2.45 |
| G          | 0.002  | 0.008 | 0.05        | 0.20 |
| H          | 0.077  | 0.104 | 1.95        | 2.65 |
| K          | 0.006  | 0.016 | 0.15        | 0.41 |

**Packing Options**

| Package Type | Description                  | Quantity | Added Suffix | Industry Standard |
|--------------|------------------------------|----------|--------------|-------------------|
| S            | DO-214AA<br>Tape & Reel Pack | 2500     | RP           | EIA-481-D         |

**Tape and Reel Specification – DO-214AA**





Компания «ЭлектроПласт» предлагает заключение долгосрочных отношений при поставках импортных электронных компонентов на взаимовыгодных условиях!

Наши преимущества:

- Оперативные поставки широкого спектра электронных компонентов отечественного и импортного производства напрямую от производителей и с крупнейших мировых складов;
- Поставка более 17-ти миллионов наименований электронных компонентов;
- Поставка сложных, дефицитных, либо снятых с производства позиций;
- Оперативные сроки поставки под заказ (от 5 рабочих дней);
- Экспресс доставка в любую точку России;
- Техническая поддержка проекта, помощь в подборе аналогов, поставка прототипов;
- Система менеджмента качества сертифицирована по Международному стандарту ISO 9001;
- Лицензия ФСБ на осуществление работ с использованием сведений, составляющих государственную тайну;
- Поставка специализированных компонентов (Xilinx, Altera, Analog Devices, Intersil, Interpoint, Microsemi, Aeroflex, Peregrine, Syfer, Eurofarad, Texas Instrument, Miteq, Cobham, E2V, MA-COM, Hittite, Mini-Circuits, General Dynamics и др.);

Помимо этого, одним из направлений компании «ЭлектроПласт» является направление «Источники питания». Мы предлагаем Вам помощь Конструкторского отдела:

- Подбор оптимального решения, техническое обоснование при выборе компонента;
- Подбор аналогов;
- Консультации по применению компонента;
- Поставка образцов и прототипов;
- Техническая поддержка проекта;
- Защита от снятия компонента с производства.



#### Как с нами связаться

**Телефон:** 8 (812) 309 58 32 (многоканальный)

**Факс:** 8 (812) 320-02-42

**Электронная почта:** [org@eplast1.ru](mailto:org@eplast1.ru)

**Адрес:** 198099, г. Санкт-Петербург, ул. Калинина, дом 2, корпус 4, литера А.