

GENERAL SPECIFICATIONS FOR S800s ~ S732

Electrical Capacity (Resistive & Inductive Load)

Power Level: Shown in the following tables

Other Ratings

Contact Resistance:	10 milliohms maximum
Insulation Resistance:	1,000 megohms minimum @ 500V DC
Dielectric Strength:	2,000V AC minimum for 1 minute minimum for S800s & S800Ds 3,000V AC minimum for 1 minute minimum for S732
Mechanical Life:	50,000 operations minimum
Electrical Life:	10,000 operations minimum for S800Ds 25,000 operations minimum for S800s & S732

Materials & Finishes

Toggle:	Brass with nickel plating for S732 Brass with chrome plating for S800s & S800Ds
Bushing:	Brass with chrome plating
Case:	Phenolic resin for S732; melamine phenol for S800s
Case Cover:	Steel with chromate plating over zinc plating
Movable Contactor Plate:	Copper with silver plating
Movable & Stationary Contacts:	Silver alloy capped on copper with silver plating
Common Terminals:	Brass
Contact Terminals:	Brass with silver or nickel plating

Environmental Data

Operating Temp Range: -10°C through +70°C (+14°F through +158°F)

Installation

Mounting Torque:	2.94Nm (26 lb•in) for double nut
Maximum Panel Thickness:	Shown beneath panel cutout in switch dimension drawings

Standards & Certifications

UL:	File No. E44145 - Recognized only when ordered with marking on switch. Add "/U" or "/CUL" to end of part number to order UL recognized switch. UL or cULus recognition designated beside part numbers on following pages. See Supplement section to find UL or cULus rating details.
CSA:	File No. 023535_0_000 - Certified only when ordered with marking on switch. Add "/C" to end of part number to order CSA certified switch. CSA certification designated beside part numbers on following pages. See Supplement section to find CSA rating details.

A
Toggles

Rockers

Pushbuttons

Illuminated PB

Programmable

Keylocks

Rotaries

Slides

Tactiles

Tilt



Touch

Indicators

Accessories

Supplement

DOUBLE POLE WITH SCREW LUG

* UL, cULus & CSA recognized only when ordered with marking on switch (see General Specs)				Toggle Position/Connected Terminals				Electrical Capacity						
Model	* Approvals			Pole & Throw	Down	Center	Up	Resistive				Inductive		Motor Load
	UL	cULus	CSA		Keyway 			AC 125V	AC 250V	DC 30V	DC 125V	AC 125V PF 0.6	AC 250V PF 0.6	AC 125V
S821	✓	✓	✓	DPST	ON 2-3 5-6	NONE	OFF —	30A	30A	30A	1A	30A	15A	750W
S822	✓	✓	✓	DPDT	ON 2-3 5-6	NONE	ON 2-1 5-4	30A	30A	30A	1A	30A	15A	—
S823	✓	✓	✓	DPDT	ON 2-3 5-6	OFF	ON 2-1 5-4	30A	30A	30A	1A	30A	15A	—



Notes: Standard Hardware: AT503M Face Hex Nut, AT506M Locking Ring, AT508 Lockwasher, AT527M Backup Hex Nut. See Accessories & Hardware section.
 Optional Splashproof Boot Assembly: AT401 boot plus hex nut & o-ring. See Accessories & Hardware section.

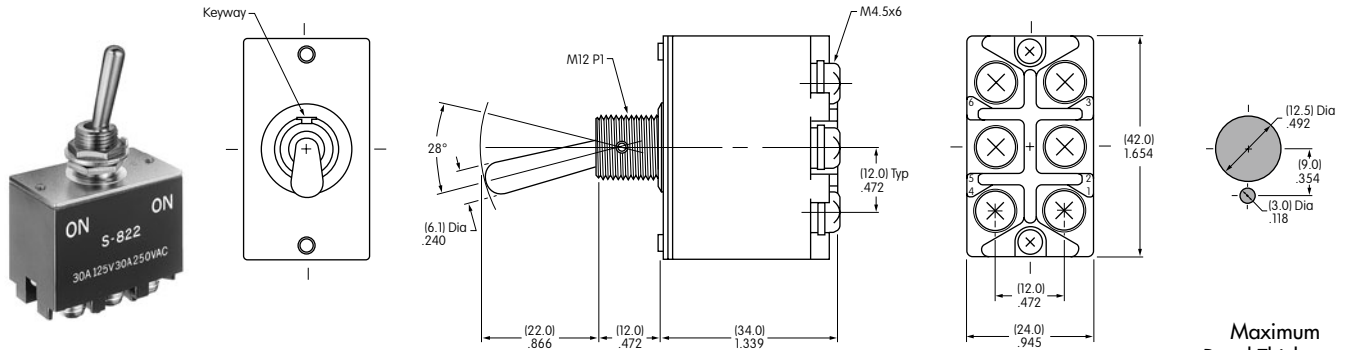



S822

S821 does not have terminals 1 & 4

Maximum Panel Thickness: .177" (4.5mm)

THREE POLE WITH SCREW LUG

* UL, cULus & CSA recognized only when ordered with marking on switch (see General Specs)				Toggle Position/Connected Terminals				Electrical Capacity					
Model	* Approvals			Pole & Throw	Down	Center	Up	Resistive				Inductive	
	UL	cULus	CSA		Keyway 			AC 125V	AC 250V	DC 30V	DC 125V	AC 125V PF 0.6	AC 250V PF 0.6
S831	✓	✓	✓	3PST	ON 2-3 5-6 8-9	NONE	OFF —	30A	30A	30A	1A	30A	15A
S832	✓	✓	✓	3PDT	ON 2-3 5-6 8-9	NONE	ON 2-1 5-4 8-7	30A	30A	30A	1A	30A	15A
S833	✓	✓	✓	3PDT	ON 2-3 5-6 8-9	OFF	ON 2-1 5-4 8-7	30A	30A	30A	1A	30A	15A



Notes: Standard Hardware: AT503M Face Hex Nut, AT506M Locking Ring, AT508 Lockwasher, AT527M Backup Hex Nut. See Accessories & Hardware section.
 Optional Splashproof Boot Assembly: AT401 boot plus hex nut & o-ring. See Accessories & Hardware section.

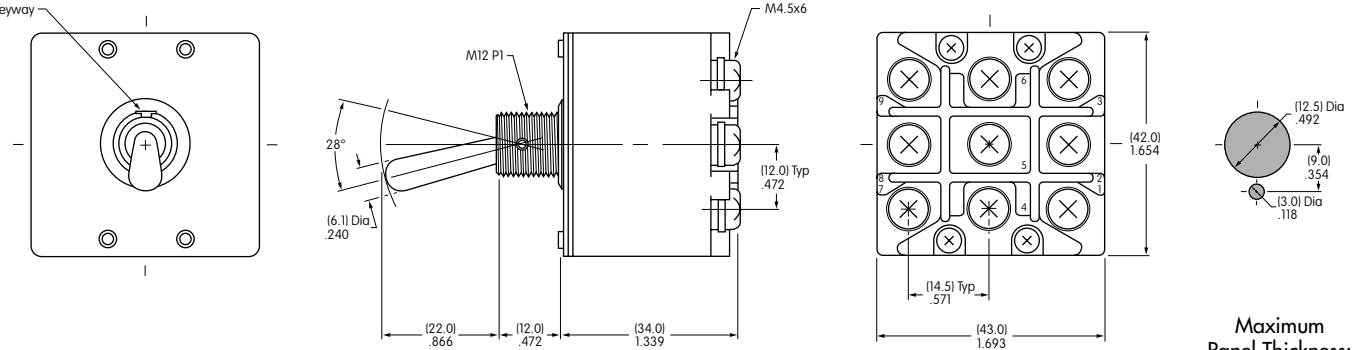



S833

S831 does not have terminals 1, 4 & 7

Maximum Panel Thickness: .177" (4.5mm)

DOUBLE POLE WITH SCREW LUG & FLATTED LEVER

* UL, cULus & CSA recognized only when ordered with marking on switch (see General Specs)

Model	*Approvals UL cULus CSA	Pole & Throw	Toggle Position/Connected Terminals						Electrical Capacity											
			Down 			Center 		Up 	Resistive				Inductive L/R = 3ms							
			ON	2-3	5-6	NONE	OFF	—	DC 30V	DC 48V	DC 125V	DC 250V	DC 400V	DC 24V	DC 48V	DC 125V	DC 250V			
S821D	✓	✓	✓	DPST	ON	2-3	5-6	NONE	OFF	—	30A	30A	20A	15A	4A (10A)	15A	10A	6A	3A	
S822D	✓	✓	✓	DPDT	ON	2-3	5-6	NONE	ON	2-1	5-4	30A	30A	20A	15A	4A	15A	10A	6A	3A
S823D	✓	✓	✓	DPDT	ON	2-3	5-6	OFF	ON	2-1	5-4	30A	30A	15A	7.5A	—	15A	10A	6A	3A

() capacity is due to wiring. Refer to instructions below.

Throw & Schematics:

DPST

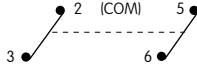

DPDT

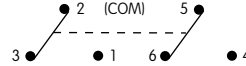

Note: Terminal numbers are on the switch

Notes: Standard Hardware: AT503M Face Hex Nut, AT506M Locking Ring, AT508 Lockwasher, AT527M Backup Hex Nut. See Accessories & Hardware section.

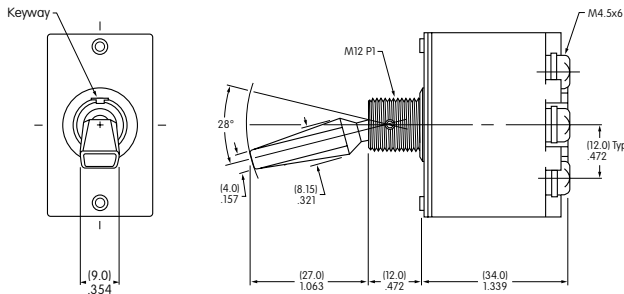

Double Pole

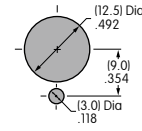
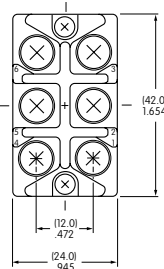

Maximum Panel Thickness: .177" (4.5mm)



S822D

S821D does not have terminals 1 & 4

400V DC WIRING INSTRUCTIONS

1. DC switch use

- Middle terminal shall be the minus pole when using DC circuit. Switch case is marked with (+) and (-).
- Do not store near (5cm) highly magnetic items.
- If actuation is interrupted when switching from ON to OFF, arcing may continue and switch could be burned.

2. Wiring for DC400V 10A



3. Inductive load

Inductive loads produce an arc caused by counter-electromotive force when opening the circuit. Recommend inserting spark elimination circuit. Contact factory for details.

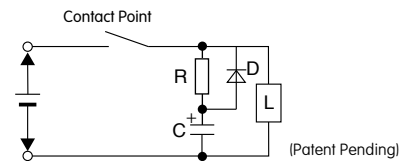

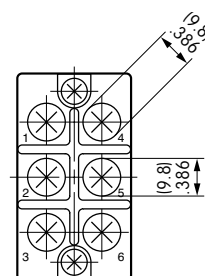

4. Compressed terminal connection

When connecting screw terminal with compressed terminal, select compressed terminal using drawing below.



THREE POLE WITH SCREW LUG & FLATTED LEVER

* UL, cULus & CSA recognized only when ordered with marking on switch (see General Specs)

Model	* Approvals			Pole & Throw	Toggle Position/Connected Terminals			Electrical Capacity							
	UL	cULus	CSA		Down	Center	Up	Resistive				Inductive L/R = 3ms			
					Keyway 			DC 30V	DC 48V	DC 125V	DC 250V	DC 24V	DC 48V	DC 125V	DC 250V
S831D	✓	✓	✓	3PST	ON 2-3 5-6 8-9	NONE	OFF —	30A	30A	15A	7.5A	15A	10A	6A	3A
S832D	✓	✓	✓	3PDT	ON 2-3 5-6 8-9	NONE	ON 2-1 5-4 8-7	30A	30A	15A	7.5A	15A	10A	6A	3A
S833D	✓	✓	✓	3PDT	ON 2-3 5-6 8-9	OFF	ON 2-1 5-4 8-7	30A	30A	15A	7.5A	15A	10A	6A	3A

Throw & Schematics:



Note: Terminal numbers are on the switch

Notes: Standard Hardware: AT503M Face Hex Nut, AT506M Locking Ring, AT508 Lockwasher, AT527M Backup Hex Nut. See Accessories & Hardware section.

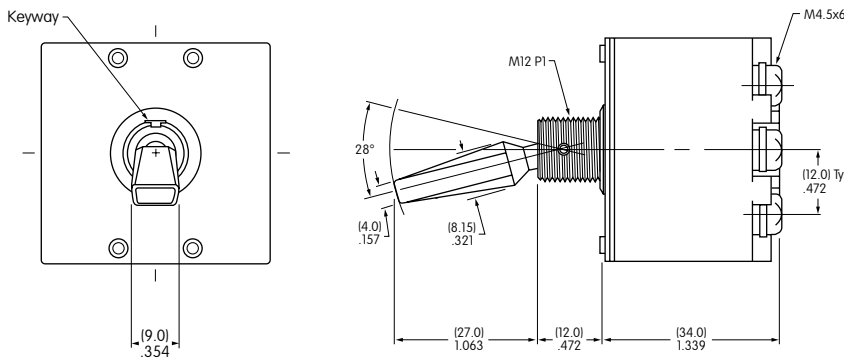

Three Pole

S831D does not have terminals 1, 4 & 7.
Positive (+) must be connected to end terminals & negative to common terminals



S832D

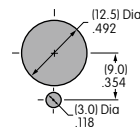

Maximum Panel Thickness: .177" (4.5mm)

Toggles
 Rockers
 Pushbuttons
 Illuminated PB
 Programmable
 Keylocks
 Rotaries
 Slides
 Tactiles
 Tilt
 Touch
 Indicators
 Accessories
 Supplement

DOUBLE POLE WITH SCREW LUG

Model	Approvals UL SP	Pole & Throw	Toggle Position/Connected Terminals			Electrical Capacity			
			Down 	Center 	Up 	Resistive			Inductive
						AC 125V	AC 250V	DC 30V	AC 125V PF 0.6
S732	— —	DPDT	ON 2-3 5-6	NONE	ON 2-1 5-4	50A	30A	50A	25A

Throw & Schematics:

DPDT



Note: Terminal numbers are on the switch

Notes: Standard Hardware: AT503M Face Hex Nut, AT506M Locking Ring, AT508 Lockwasher, AT527M Backup Hex Nut. See Accessories & Hardware section.

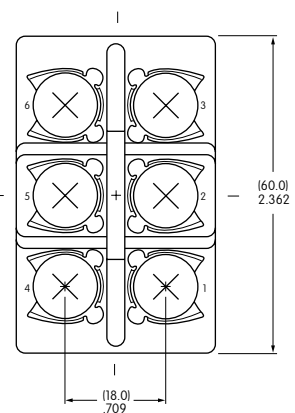
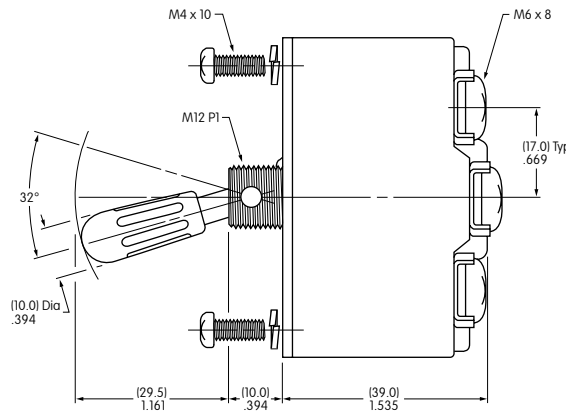
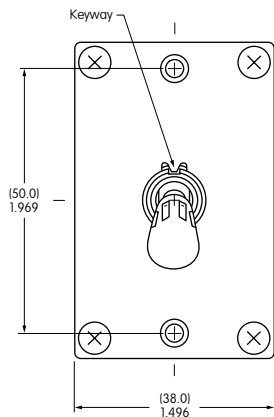

Cap of phenolic resin is black

Panel Mount with Mounting Screws

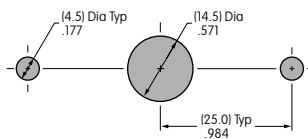

Maximum Panel Thickness: .158" (4.0mm)

Panel Mount with Bushing Hardware

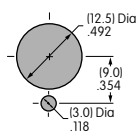

Maximum Panel Thickness: .079" (2.0mm)

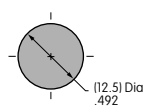

Maximum Panel Thickness: .118" (3.0mm)

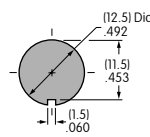

Maximum Panel Thickness: .118" (3.0mm)



S732



Компания «ЭлектроПласт» предлагает заключение долгосрочных отношений при поставках импортных электронных компонентов на взаимовыгодных условиях!

Наши преимущества:

- Оперативные поставки широкого спектра электронных компонентов отечественного и импортного производства напрямую от производителей и с крупнейших мировых складов;
- Поставка более 17-ти миллионов наименований электронных компонентов;
- Поставка сложных, дефицитных, либо снятых с производства позиций;
- Оперативные сроки поставки под заказ (от 5 рабочих дней);
- Экспресс доставка в любую точку России;
- Техническая поддержка проекта, помощь в подборе аналогов, поставка прототипов;
- Система менеджмента качества сертифицирована по Международному стандарту ISO 9001;
- Лицензия ФСБ на осуществление работ с использованием сведений, составляющих государственную тайну;
- Поставка специализированных компонентов (Xilinx, Altera, Analog Devices, Intersil, Interpoint, Microsemi, Aeroflex, Peregrine, Syfer, Eurofarad, Texas Instrument, Miteq, Cobham, E2V, MA-COM, Hittite, Mini-Circuits, General Dynamics и др.);

Помимо этого, одним из направлений компании «ЭлектроПласт» является направление «Источники питания». Мы предлагаем Вам помощь Конструкторского отдела:

- Подбор оптимального решения, техническое обоснование при выборе компонента;
- Подбор аналогов;
- Консультации по применению компонента;
- Поставка образцов и прототипов;
- Техническая поддержка проекта;
- Защита от снятия компонента с производства.



Как с нами связаться

Телефон: 8 (812) 309 58 32 (многоканальный)

Факс: 8 (812) 320-02-42

Электронная почта: org@eplast1.ru

Адрес: 198099, г. Санкт-Петербург, ул. Калинина, дом 2, корпус 4, литера А.