

## GENERAL SPECIFICATIONS FOR S800s ~ S732

### Electrical Capacity (Resistive & Inductive Load)

**Power Level:** Shown in the following tables

### Other Ratings

<b>Contact Resistance:</b>	10 milliohms maximum
<b>Insulation Resistance:</b>	1,000 megohms minimum @ 500V DC
<b>Dielectric Strength:</b>	2,000V AC minimum for 1 minute minimum for S800s & S800Ds 3,000V AC minimum for 1 minute minimum for S732
<b>Mechanical Life:</b>	50,000 operations minimum
<b>Electrical Life:</b>	10,000 operations minimum for S800Ds 25,000 operations minimum for S800s & S732

### Materials & Finishes

<b>Toggle:</b>	Brass with nickel plating for S732 Brass with chrome plating for S800s & S800Ds
<b>Bushing:</b>	Brass with chrome plating
<b>Case:</b>	Phenolic resin for S732; melamine phenol for S800s
<b>Case Cover:</b>	Steel with chromate plating over zinc plating
<b>Movable Contactor Plate:</b>	Copper with silver plating
<b>Movable &amp; Stationary Contacts:</b>	Silver alloy capped on copper with silver plating
<b>Common Terminals:</b>	Brass
<b>Contact Terminals:</b>	Brass with silver or nickel plating

### Environmental Data

**Operating Temp Range:** -10°C through +70°C (+14°F through +158°F)

### Installation

<b>Mounting Torque:</b>	2.94Nm (26 lb•in) for double nut
<b>Maximum Panel Thickness:</b>	Shown beneath panel cutout in switch dimension drawings

### Standards & Certifications

<b>UL:</b>	<b>File No. E44145 - Recognized only when ordered with marking on switch.</b> Add "/U" or "/CUL" to end of part number to order UL recognized switch. UL or cULus recognition designated beside part numbers on following pages. See Supplement section to find UL or cULus rating details.
<b>CSA:</b>	<b>File No. 023535_0_000 - Certified only when ordered with marking on switch.</b> Add "/C" to end of part number to order CSA certified switch. CSA certification designated beside part numbers on following pages. See Supplement section to find CSA rating details.

A  
Toggles

Rockers

Pushbuttons

Illuminated PB

Programmable

Keylocks

Rotaries

Slides

Tactiles

Tilt



Touch

Indicators

Accessories

Supplement

## DOUBLE POLE WITH SCREW LUG

* UL, cULus & CSA recognized only when ordered with marking on switch (see General Specs)				Toggle Position/Connected Terminals				Electrical Capacity						
Model	* Approvals			Pole & Throw	Down 	Center 	Up 	Resistive				Inductive		Motor Load
	UL	cULus	CSA					AC 125V	AC 250V	DC 30V	DC 125V	AC 125V PF 0.6	AC 250V PF 0.6	AC 125V
S821	✓	✓	✓	DPST	ON 2-3 5-6	NONE	OFF —	30A	30A	30A	1A	30A	15A	750W
S822	✓	✓	✓	DPDT	ON 2-3 5-6	NONE	ON 2-1 5-4	30A	30A	30A	1A	30A	15A	—
S823	✓	✓	✓	DPDT	ON 2-3 5-6	OFF	ON 2-1 5-4	30A	30A	30A	1A	30A	15A	—



**Notes:** Standard Hardware: AT503M Face Hex Nut, AT506M Locking Ring, AT508 Lockwasher, AT527M Backup Hex Nut. See Accessories & Hardware section. Optional Splashproof Boot Assembly: AT401 boot plus hex nut & o-ring. See Accessories & Hardware section.

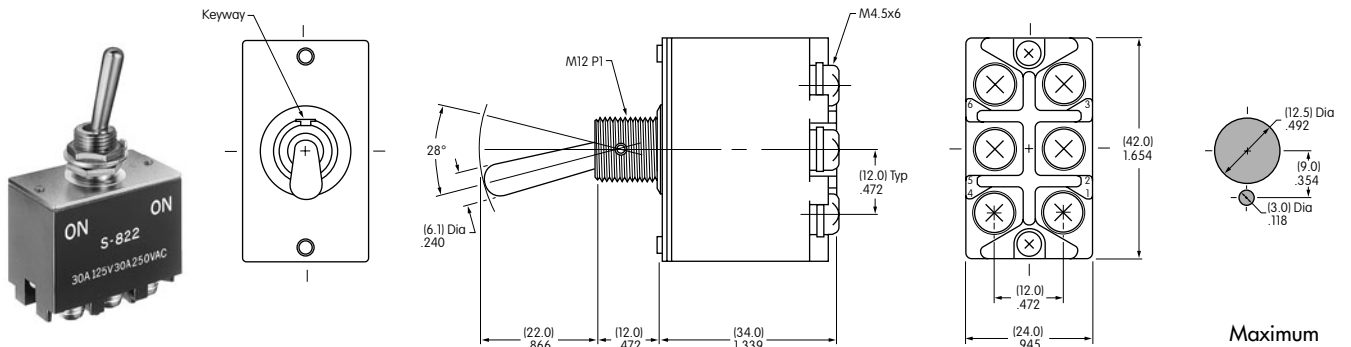



S822

S821 does not have terminals 1 & 4

Maximum Panel Thickness: .177" (4.5mm)

## THREE POLE WITH SCREW LUG

* UL, cULus & CSA recognized only when ordered with marking on switch (see General Specs)				Toggle Position/Connected Terminals				Electrical Capacity					
Model	* Approvals			Pole & Throw	Down 	Center 	Up 	Resistive				Inductive	
	UL	cULus	CSA					AC 125V	AC 250V	DC 30V	DC 125V	AC 125V PF 0.6	AC 250V PF 0.6
S831	✓	✓	✓	3PST	ON 2-3 5-6 8-9	NONE	OFF —	30A	30A	30A	1A	30A	15A
S832	✓	✓	✓	3PDT	ON 2-3 5-6 8-9	NONE	ON 2-1 5-4 8-7	30A	30A	30A	1A	30A	15A
S833	✓	✓	✓	3PDT	ON 2-3 5-6 8-9	OFF	ON 2-1 5-4 8-7	30A	30A	30A	1A	30A	15A

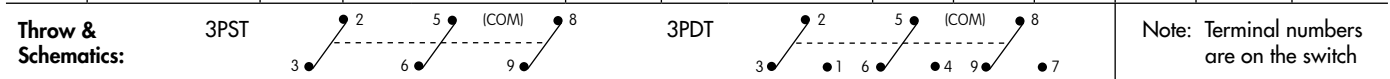

**Notes:** Standard Hardware: AT503M Face Hex Nut, AT506M Locking Ring, AT508 Lockwasher, AT527M Backup Hex Nut. See Accessories & Hardware section. Optional Splashproof Boot Assembly: AT401 boot plus hex nut & o-ring. See Accessories & Hardware section.

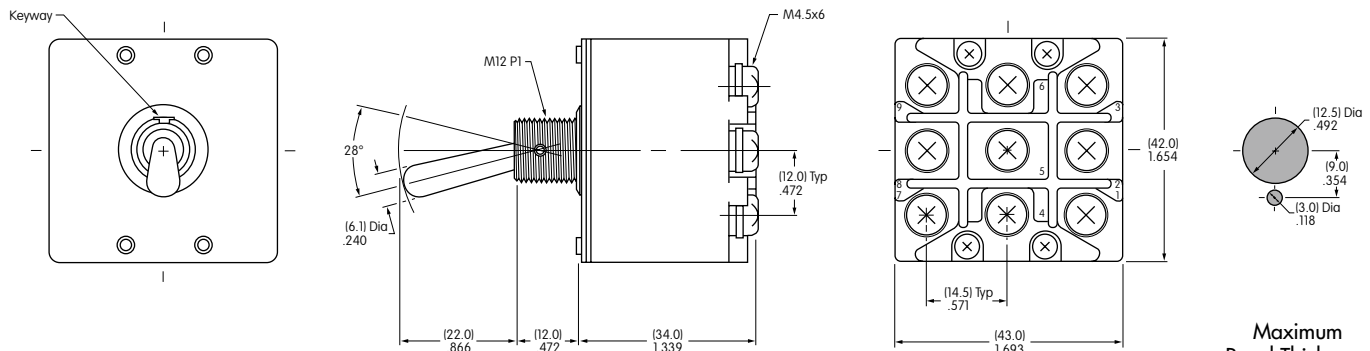



S833

S831 does not have terminals 1, 4 & 7

Maximum Panel Thickness: .177" (4.5mm)

## DOUBLE POLE WITH SCREW LUG & FLATTED LEVER

\* UL, cULus & CSA recognized only when ordered with marking on switch (see General Specs)

Model	*Approvals UL cULus CSA	Pole & Throw	Toggle Position/Connected Terminals						Electrical Capacity											
			Down 			Center 		Up 	Resistive				Inductive L/R = 3ms							
			ON	2-3	5-6	NONE	OFF	—	DC 30V	DC 48V	DC 125V	DC 250V	DC 400V	DC 24V	DC 48V	DC 125V	DC 250V			
S821D	✓	✓	✓	DPST	ON	2-3	5-6	NONE	OFF	—	30A	30A	20A	15A	4A (10A)	15A	10A	6A	3A	
S822D	✓	✓	✓	DPDT	ON	2-3	5-6	NONE	ON	2-1	5-4	30A	30A	20A	15A	4A	15A	10A	6A	3A
S823D	✓	✓	✓	DPDT	ON	2-3	5-6	OFF	ON	2-1	5-4	30A	30A	15A	7.5A	—	15A	10A	6A	3A

( ) capacity is due to wiring. Refer to instructions below.

Throw & Schematics:

DPST

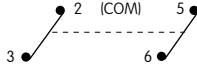

DPDT

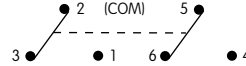

Note: Terminal numbers are on the switch

Notes: Standard Hardware: AT503M Face Hex Nut, AT506M Locking Ring, AT508 Lockwasher, AT527M Backup Hex Nut. See Accessories & Hardware section.

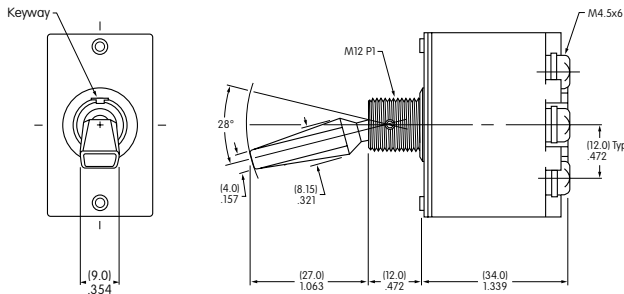

### Double Pole

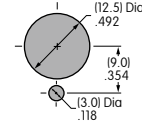
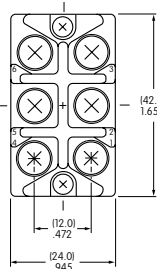

Maximum Panel Thickness: .177" (4.5mm)



S822D

S821D does not have terminals 1 & 4

## 400V DC WIRING INSTRUCTIONS

### 1. DC switch use

- Middle terminal shall be the minus pole when using DC circuit. Switch case is marked with (+) and (-).
- Do not store near (5cm) highly magnetic items.
- If actuation is interrupted when switching from ON to OFF, arcing may continue and switch could be burned.

### 2. Wiring for DC400V 10A



### 3. Inductive load

Inductive loads produce an arc caused by counter-electromotive force when opening the circuit. Recommend inserting spark elimination circuit. Contact factory for details.

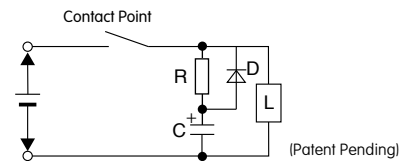

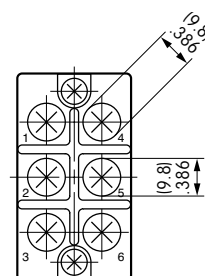

### 4. Compressed terminal connection

When connecting screw terminal with compressed terminal, select compressed terminal using drawing below.



## THREE POLE WITH SCREW LUG & FLATTED LEVER

\* UL, cULus & CSA recognized only when ordered with marking on switch (see General Specs)

Model	* Approvals			Pole & Throw	Toggle Position/Connected Terminals			Electrical Capacity							
	UL	cULus	CSA		Down	Center	Up	Resistive				Inductive L/R = 3ms			
					Keyway 			DC 30V	DC 48V	DC 125V	DC 250V	DC 24V	DC 48V	DC 125V	DC 250V
S831D	✓	✓	✓	3PST	ON 2-3 5-6 8-9	NONE	OFF —	30A	30A	15A	7.5A	15A	10A	6A	3A
S832D	✓	✓	✓	3PDT	ON 2-3 5-6 8-9	NONE	ON 2-1 5-4 8-7	30A	30A	15A	7.5A	15A	10A	6A	3A
S833D	✓	✓	✓	3PDT	ON 2-3 5-6 8-9	OFF	ON 2-1 5-4 8-7	30A	30A	15A	7.5A	15A	10A	6A	3A

Throw & Schematics:



Note: Terminal numbers are on the switch

Notes: Standard Hardware: AT503M Face Hex Nut, AT506M Locking Ring, AT508 Lockwasher, AT527M Backup Hex Nut. See Accessories & Hardware section.

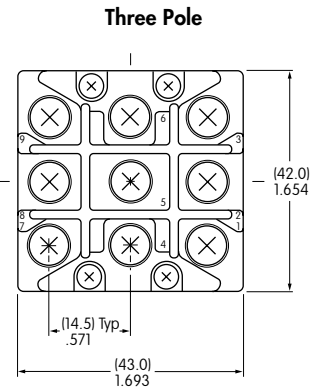
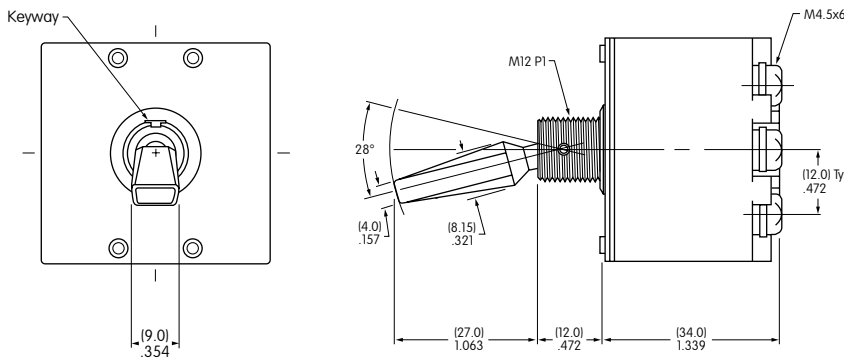

S831D does not have terminals 1, 4 & 7.  
Positive (+) must be connected to end terminals & negative to common terminals



S832D

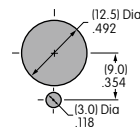

Maximum Panel Thickness: .177" (4.5mm)

## DOUBLE POLE WITH SCREW LUG

Model	Approvals UL SP	Pole & Throw	Toggle Position/Connected Terminals			Electrical Capacity			
			Down 	Center 	Up 	Resistive		Inductive	
			AC 125V	AC 250V	DC 30V	AC 125V PF 0.6			
S732	— —	DPDT	ON 2-3 5-6	NONE	ON 2-1 5-4	50A	30A	50A	25A

### Throw & Schematics:

DPDT



Note: Terminal numbers are on the switch

Notes: Standard Hardware: AT503M Face Hex Nut, AT506M Locking Ring, AT508 Lockwasher, AT527M Backup Hex Nut. See Accessories & Hardware section.

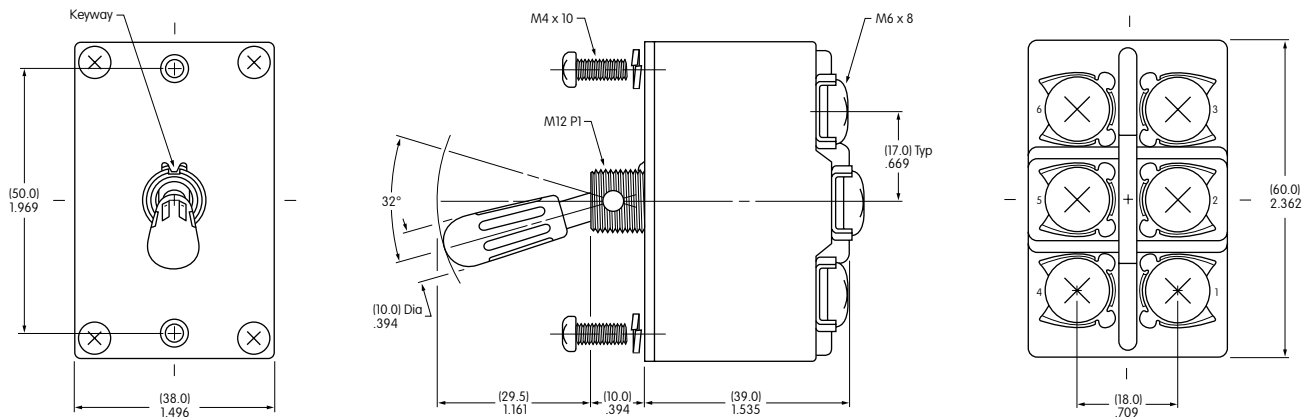

Cap of phenolic resin is black

### Panel Mount with Mounting Screws

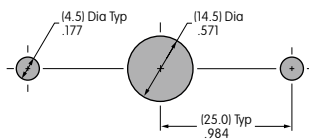

Maximum Panel Thickness: .158" (4.0mm)

### Panel Mount with Bushing Hardware

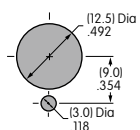

Maximum Panel Thickness: .079" (2.0mm)

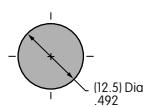

Maximum Panel Thickness: .118" (3.0mm)

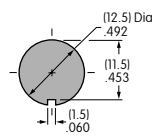

Maximum Panel Thickness: .118" (3.0mm)



S732



Компания «ЭлектроПласт» предлагает заключение долгосрочных отношений при поставках импортных электронных компонентов на взаимовыгодных условиях!

Наши преимущества:

- Оперативные поставки широкого спектра электронных компонентов отечественного и импортного производства напрямую от производителей и с крупнейших мировых складов;
- Поставка более 17-ти миллионов наименований электронных компонентов;
- Поставка сложных, дефицитных, либо снятых с производства позиций;
- Оперативные сроки поставки под заказ (от 5 рабочих дней);
- Экспресс доставка в любую точку России;
- Техническая поддержка проекта, помощь в подборе аналогов, поставка прототипов;
- Система менеджмента качества сертифицирована по Международному стандарту ISO 9001;
- Лицензия ФСБ на осуществление работ с использованием сведений, составляющих государственную тайну;
- Поставка специализированных компонентов (Xilinx, Altera, Analog Devices, Intersil, Interpoint, Microsemi, Aeroflex, Peregrine, Syfer, Eurofarad, Texas Instrument, Miteq, Cobham, E2V, MA-COM, Hittite, Mini-Circuits, General Dynamics и др.);

Помимо этого, одним из направлений компании «ЭлектроПласт» является направление «Источники питания». Мы предлагаем Вам помощь Конструкторского отдела:

- Подбор оптимального решения, техническое обоснование при выборе компонента;
- Подбор аналогов;
- Консультации по применению компонента;
- Поставка образцов и прототипов;
- Техническая поддержка проекта;
- Защита от снятия компонента с производства.



#### Как с нами связаться

**Телефон:** 8 (812) 309 58 32 (многоканальный)

**Факс:** 8 (812) 320-02-42

**Электронная почта:** [org@eplast1.ru](mailto:org@eplast1.ru)

**Адрес:** 198099, г. Санкт-Петербург, ул. Калинина, дом 2, корпус 4, литера А.