

GENERAL SPECIFICATIONS FOR S800s ~ S732

Electrical Capacity (Resistive & Inductive Load)

Power Level: Shown in the following tables

Other Ratings

| | |
|-------------------------------|--|
| Contact Resistance: | 10 milliohms maximum |
| Insulation Resistance: | 1,000 megohms minimum @ 500V DC |
| Dielectric Strength: | 2,000V AC minimum for 1 minute minimum for S800s & S800Ds 3,000V AC minimum for 1 minute minimum for S732 |
| Mechanical Life: | 50,000 operations minimum |
| Electrical Life: | 10,000 operations minimum for S800Ds 25,000 operations minimum for S800s & S732 |

Materials & Finishes

| | |
|---|--|
| Toggle: | Brass with nickel plating for S732 Brass with chrome plating for S800s & S800Ds |
| Bushing: | Brass with chrome plating |
| Case: | Phenolic resin for S732; melamine phenol for S800s |
| Case Cover: | Steel with chromate plating over zinc plating |
| Movable Contactor Plate: | Copper with silver plating |
| Movable & Stationary Contacts: | Silver alloy capped on copper with silver plating |
| Common Terminals: | Brass |
| Contact Terminals: | Brass with silver or nickel plating |

Environmental Data

Operating Temp Range: -10°C through +70°C (+14°F through +158°F)

Installation

| | |
|---------------------------------|---|
| Mounting Torque: | 2.94Nm (26 lb•in) for double nut |
| Maximum Panel Thickness: | Shown beneath panel cutout in switch dimension drawings |

Standards & Certifications

| | |
|-------------|--|
| UL: | File No. E44145 - Recognized only when ordered with marking on switch. Add "/U" or "/CUL" to end of part number to order UL recognized switch. UL or cULus recognition designated beside part numbers on following pages. See Supplement section to find UL or cULus rating details. |
| CSA: | File No. 023535_0_000 - Certified only when ordered with marking on switch. Add "/C" to end of part number to order CSA certified switch. CSA certification designated beside part numbers on following pages. See Supplement section to find CSA rating details. |

A
Toggles

Rockers

Pushbuttons

Illuminated PB

Programmable

Keylocks

Rotaries

Slides

Tactiles

Tilt



Touch

Indicators

Accessories

Supplement

DOUBLE POLE WITH SCREW LUG

| * UL, cULus & CSA recognized only when ordered with marking on switch (see General Specs) | | | | Toggle Position/Connected Terminals | | | | Electrical Capacity | | | | | | |
|---|-------------|-------|-----|-------------------------------------|---|---|---|---------------------|---------|--------|---------|----------------|----------------|------------|
| Model | * Approvals | | | Pole & Throw | Down  | Center  | Up  | Resistive | | | | Inductive | | Motor Load |
| | UL | cULus | CSA | | | | | AC 125V | AC 250V | DC 30V | DC 125V | AC 125V PF 0.6 | AC 250V PF 0.6 | AC 125V |
| S821 | ✓ | ✓ | ✓ | DPST | ON 2-3 5-6 | NONE | OFF — | 30A | 30A | 30A | 1A | 30A | 15A | 750W |
| S822 | ✓ | ✓ | ✓ | DPDT | ON 2-3 5-6 | NONE | ON 2-1 5-4 | 30A | 30A | 30A | 1A | 30A | 15A | — |
| S823 | ✓ | ✓ | ✓ | DPDT | ON 2-3 5-6 | OFF | ON 2-1 5-4 | 30A | 30A | 30A | 1A | 30A | 15A | — |



Notes: Standard Hardware: AT503M Face Hex Nut, AT506M Locking Ring, AT508 Lockwasher, AT527M Backup Hex Nut. See Accessories & Hardware section.
Optional Splashproof Boot Assembly: AT401 boot plus hex nut & o-ring. See Accessories & Hardware section.

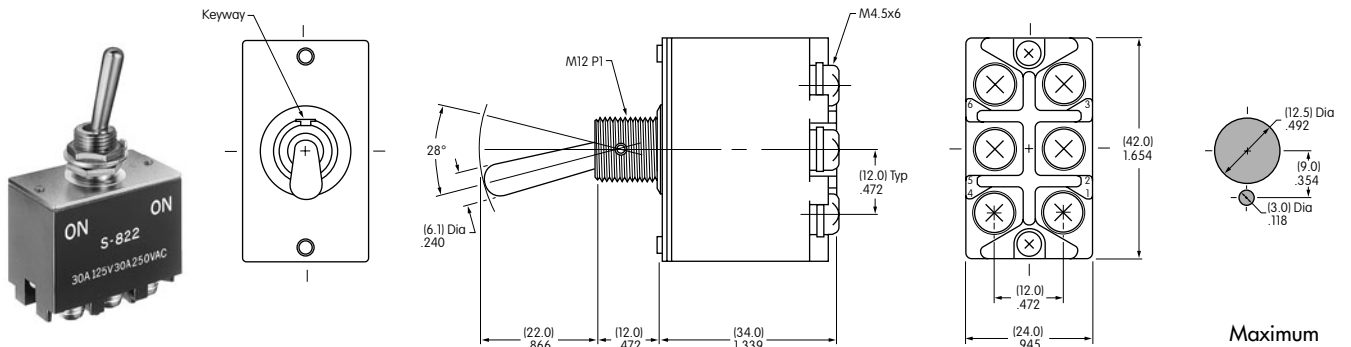



S822

S821 does not have terminals 1 & 4

Maximum Panel Thickness: .177" (4.5mm)

THREE POLE WITH SCREW LUG

| * UL, cULus & CSA recognized only when ordered with marking on switch (see General Specs) | | | | Toggle Position/Connected Terminals | | | | Electrical Capacity | | | | | |
|---|-------------|-------|-----|-------------------------------------|---|---|---|---------------------|---------|--------|---------|----------------|----------------|
| Model | * Approvals | | | Pole & Throw | Down  | Center  | Up  | Resistive | | | | Inductive | |
| | UL | cULus | CSA | | | | | AC 125V | AC 250V | DC 30V | DC 125V | AC 125V PF 0.6 | AC 250V PF 0.6 |
| S831 | ✓ | ✓ | ✓ | 3PST | ON 2-3 5-6 8-9 | NONE | OFF — | 30A | 30A | 30A | 1A | 30A | 15A |
| S832 | ✓ | ✓ | ✓ | 3PDT | ON 2-3 5-6 8-9 | NONE | ON 2-1 5-4 8-7 | 30A | 30A | 30A | 1A | 30A | 15A |
| S833 | ✓ | ✓ | ✓ | 3PDT | ON 2-3 5-6 8-9 | OFF | ON 2-1 5-4 8-7 | 30A | 30A | 30A | 1A | 30A | 15A |

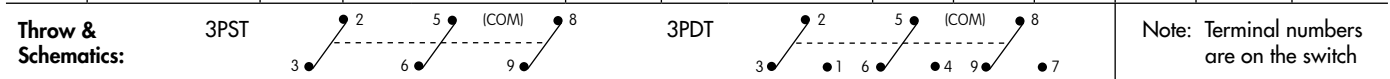

Notes: Standard Hardware: AT503M Face Hex Nut, AT506M Locking Ring, AT508 Lockwasher, AT527M Backup Hex Nut. See Accessories & Hardware section.
Optional Splashproof Boot Assembly: AT401 boot plus hex nut & o-ring. See Accessories & Hardware section.

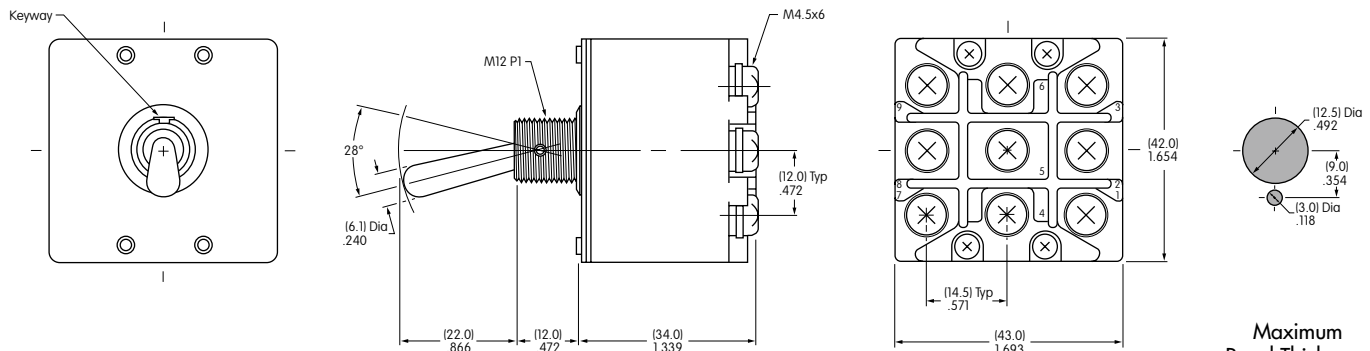



S833

S831 does not have terminals 1, 4 & 7

Maximum Panel Thickness: .177" (4.5mm)

DOUBLE POLE WITH SCREW LUG & FLATTED LEVER

* UL, cULus & CSA recognized only when ordered with marking on switch (see General Specs)

| Model | *Approvals UL cULus CSA | Pole & Throw | Toggle Position/Connected Terminals | | | | | | Electrical Capacity | | | | | | | | | | | |
|-------|----------------------------|--------------|---|------|-----|---|-----|---|---------------------|--------|---------|---------|---------------------|--------|----------|---------|---------|-----|----|----|
| | | | Down  | | | Center  | | Up  | Resistive | | | | Inductive L/R = 3ms | | | | | | | |
| | | | ON | 2-3 | 5-6 | NONE | OFF | — | DC 30V | DC 48V | DC 125V | DC 250V | DC 400V | DC 24V | DC 48V | DC 125V | DC 250V | | | |
| S821D | ✓ | ✓ | ✓ | DPST | ON | 2-3 | 5-6 | NONE | OFF | — | 30A | 30A | 20A | 15A | 4A (10A) | 15A | 10A | 6A | 3A | |
| S822D | ✓ | ✓ | ✓ | DPDT | ON | 2-3 | 5-6 | NONE | ON | 2-1 | 5-4 | 30A | 30A | 20A | 15A | 4A | 15A | 10A | 6A | 3A |
| S823D | ✓ | ✓ | ✓ | DPDT | ON | 2-3 | 5-6 | OFF | ON | 2-1 | 5-4 | 30A | 30A | 15A | 7.5A | — | 15A | 10A | 6A | 3A |

() capacity is due to wiring. Refer to instructions below.

Throw & Schematics:

DPST

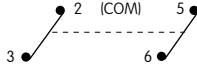

DPDT

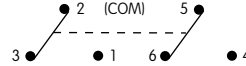

Note: Terminal numbers are on the switch

Notes: Standard Hardware: AT503M Face Hex Nut, AT506M Locking Ring, AT508 Lockwasher, AT527M Backup Hex Nut. See Accessories & Hardware section.

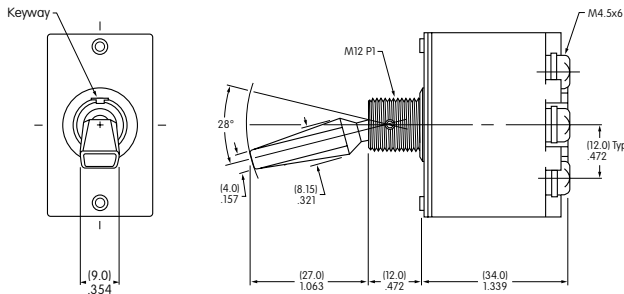

Double Pole

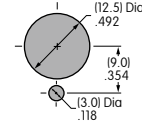
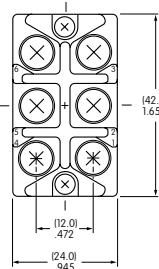

Maximum Panel Thickness: .177" (4.5mm)



S822D

S821D does not have terminals 1 & 4

400V DC WIRING INSTRUCTIONS

1. DC switch use

- Middle terminal shall be the minus pole when using DC circuit. Switch case is marked with (+) and (-).
- Do not store near (5cm) highly magnetic items.
- If actuation is interrupted when switching from ON to OFF, arcing may continue and switch could be burned.

2. Wiring for DC400V 10A



3. Inductive load

Inductive loads produce an arc caused by counter-electromotive force when opening the circuit. Recommend inserting spark elimination circuit. Contact factory for details.

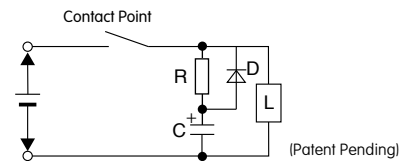

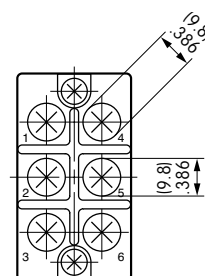

4. Compressed terminal connection

When connecting screw terminal with compressed terminal, select compressed terminal using drawing below.



THREE POLE WITH SCREW LUG & FLATTED LEVER

* UL, cULus & CSA recognized only when ordered with marking on switch (see General Specs)

| Model | * Approvals | | | Pole & Throw | Toggle Position/Connected Terminals | | | Electrical Capacity | | | | | | | |
|-------|-------------|-------|-----|--------------|--|---|---|---------------------|--------|---------|---------|---------------------|--------|---------|---------|
| | UL | cULus | CSA | | Down | Center | Up | Resistive | | | | Inductive L/R = 3ms | | | |
| | | | | | Keyway  |  |  | DC 30V | DC 48V | DC 125V | DC 250V | DC 24V | DC 48V | DC 125V | DC 250V |
| S831D | ✓ | ✓ | ✓ | 3PST | ON 2-3 5-6 8-9 | NONE | OFF — | 30A | 30A | 15A | 7.5A | 15A | 10A | 6A | 3A |
| S832D | ✓ | ✓ | ✓ | 3PDT | ON 2-3 5-6 8-9 | NONE | ON 2-1 5-4 8-7 | 30A | 30A | 15A | 7.5A | 15A | 10A | 6A | 3A |
| S833D | ✓ | ✓ | ✓ | 3PDT | ON 2-3 5-6 8-9 | OFF | ON 2-1 5-4 8-7 | 30A | 30A | 15A | 7.5A | 15A | 10A | 6A | 3A |

Throw & Schematics:



Note: Terminal numbers are on the switch

Notes: Standard Hardware: AT503M Face Hex Nut, AT506M Locking Ring, AT508 Lockwasher, AT527M Backup Hex Nut. See Accessories & Hardware section.

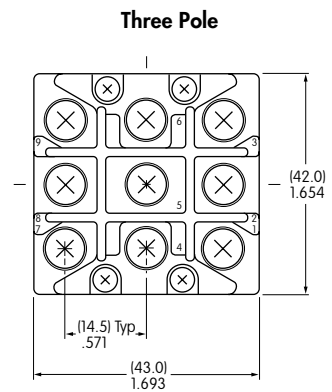
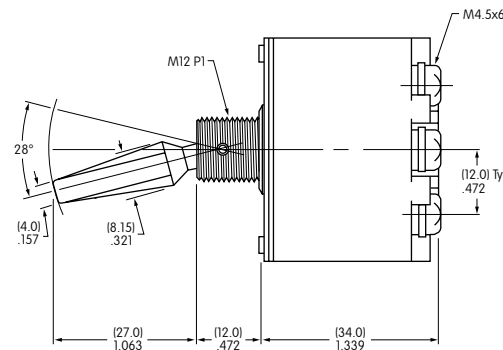
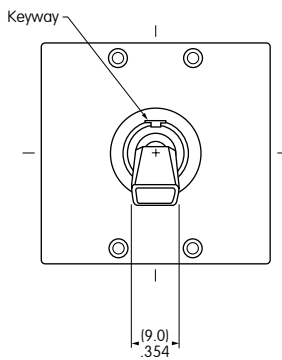

S831D does not have terminals 1, 4 & 7.
Positive (+) must be connected to end terminals & negative to common terminals



S832D

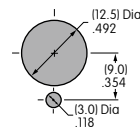

Maximum Panel Thickness: .177" (4.5mm)

DOUBLE POLE WITH SCREW LUG

| Model | Approvals UL SP | Pole & Throw | Toggle Position/Connected Terminals | | | Electrical Capacity | | | |
|-------|--------------------|--------------|---|---|---|---------------------|-----|-----------|-----|
| | | | Down  | Center  | Up  | Resistive | | Inductive | |
| | | | AC 125V | AC 250V | DC 30V | AC 125V PF 0.6 | | | |
| S732 | — — | DPDT | ON 2-3 5-6 | NONE | ON 2-1 5-4 | 50A | 30A | 50A | 25A |

Throw & Schematics:

DPDT



Note: Terminal numbers are on the switch

Notes: Standard Hardware: AT503M Face Hex Nut, AT506M Locking Ring, AT508 Lockwasher, AT527M Backup Hex Nut. See Accessories & Hardware section.

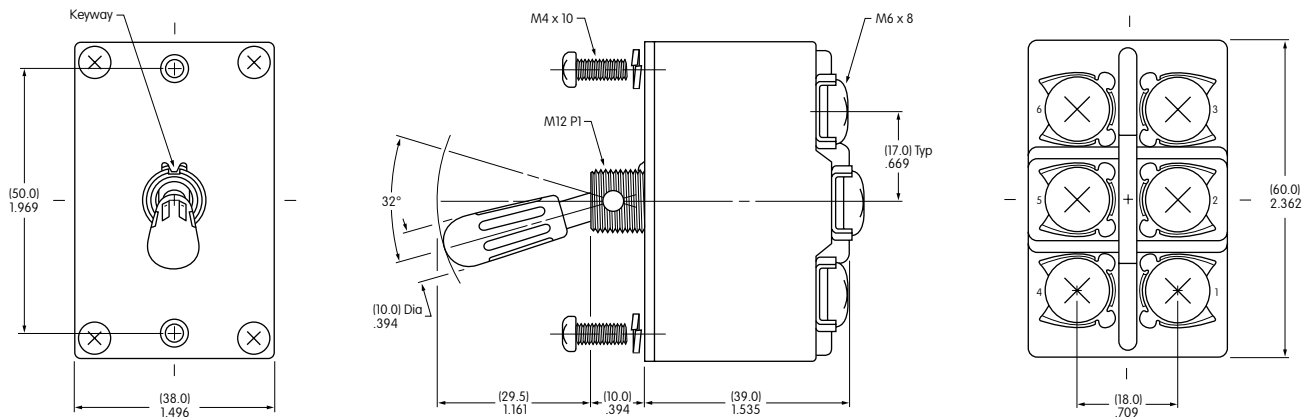

Cap of phenolic resin is black

Panel Mount with Mounting Screws

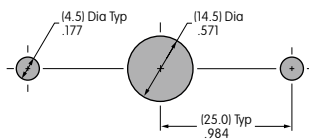

Maximum Panel Thickness: .158" (4.0mm)

Panel Mount with Bushing Hardware

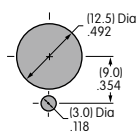

Maximum Panel Thickness: .079" (2.0mm)

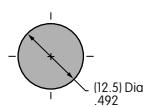

Maximum Panel Thickness: .118" (3.0mm)

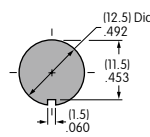

Maximum Panel Thickness: .118" (3.0mm)



S732



Компания «ЭлектроПласт» предлагает заключение долгосрочных отношений при поставках импортных электронных компонентов на взаимовыгодных условиях!

Наши преимущества:

- Оперативные поставки широкого спектра электронных компонентов отечественного и импортного производства напрямую от производителей и с крупнейших мировых складов;
- Поставка более 17-ти миллионов наименований электронных компонентов;
- Поставка сложных, дефицитных, либо снятых с производства позиций;
- Оперативные сроки поставки под заказ (от 5 рабочих дней);
- Экспресс доставка в любую точку России;
- Техническая поддержка проекта, помощь в подборе аналогов, поставка прототипов;
- Система менеджмента качества сертифицирована по Международному стандарту ISO 9001;
- Лицензия ФСБ на осуществление работ с использованием сведений, составляющих государственную тайну;
- Поставка специализированных компонентов (Xilinx, Altera, Analog Devices, Intersil, Interpoint, Microsemi, Aeroflex, Peregrine, Syfer, Eurofarad, Texas Instrument, Miteq, Cobham, E2V, MA-COM, Hittite, Mini-Circuits, General Dynamics и др.);

Помимо этого, одним из направлений компании «ЭлектроПласт» является направление «Источники питания». Мы предлагаем Вам помощь Конструкторского отдела:

- Подбор оптимального решения, техническое обоснование при выборе компонента;
- Подбор аналогов;
- Консультации по применению компонента;
- Поставка образцов и прототипов;
- Техническая поддержка проекта;
- Защита от снятия компонента с производства.



Как с нами связаться

Телефон: 8 (812) 309 58 32 (многоканальный)

Факс: 8 (812) 320-02-42

Электронная почта: org@eplast1.ru

Адрес: 198099, г. Санкт-Петербург, ул. Калинина, дом 2, корпус 4, литера А.