



The Future of Analog IC Technology®

EVM3695-25-RF-02A

16V, 20A, Scalable
DC/DC Power Module with PMBus

DESCRIPTION

MPM3695-25 is a scalable and fully integrated power module with PMBus interface. MPM3695-25 offers a complete power solution that achieves up to 25A peak of output current with excellent load and line regulation over a wide input voltage range. MPM3695-25 operates at a high efficiency over a wide load range and can be paralleled to deliver up to 150A of peak current.

The MPM3695-25 adopts MPS's proprietary, multi-phase constant-on-time (MCOT) control, which provides ultra-fast transient response and simple loop compensation. The PMBus interface provides module configurations and monitoring of key parameters.

MPM3695-25 features full protection functions including over-current protection (OCP), over-voltage protection (OVP), under-voltage protection (UVP), and over-temperature protection (OTP).

MPM3695-25 requires a minimal number of readily available external components and is available in a QFN-59 (10mmx12mmx4mm) package.

FEATURES

- Wide Input Voltage Range from 3V
 - 3V-16V Input Voltage with External V_{CC}
 - 4V-16V Input Voltage with Internal V_{CC}
- 0.5V to 6V Output Voltage Range
- 20A Continuous Output Current, Peak 25A, Parallel Up to 150A Peak
- Auto-Interleaving for Multi-Phase Operation
- Auto-Compensation with Adaptive MCOT for Ultra-Fast Transient Response
- 0.5% Reference Voltage Over 0°C to +70°C Junction Temperature Range
- True Remote Sense of Output Voltage
- PMBus 1.3 Compliant
- Programmable via PMBus
 - Current Limit
 - Selection of Pulse-Skip Mode or Continuous Conduction Mode (CCM)
 - Soft-Start Time
 - Switching Frequency
 - Fault Limits
- Available in a QFN-59 (10mmx12mmx4mm) Package

APPLICATIONS

- Telecom and Networking Systems
- Industrial Equipment
- Servers and Computing

All MPS parts are lead-free, halogen free, and adhere to the RoHS directive. For MPS green status, please visit MPS website under Quality Assurance. "MPS" and "The Future of Analog IC Technology" are Registered Trademarks of Monolithic Power Systems, Inc.

EVM3695-25-RF-02A DEMO BOARD



(L x W) 8.9cm x 8.9cm

Board Number	MPS IC Number
EVM3695-25-RF-02A	MPM3695-25

Efficiency vs. Load Current

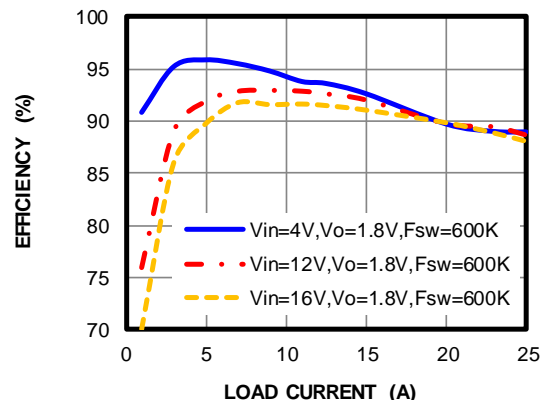

EVM3695-25-RF-02A SCHEMATIC

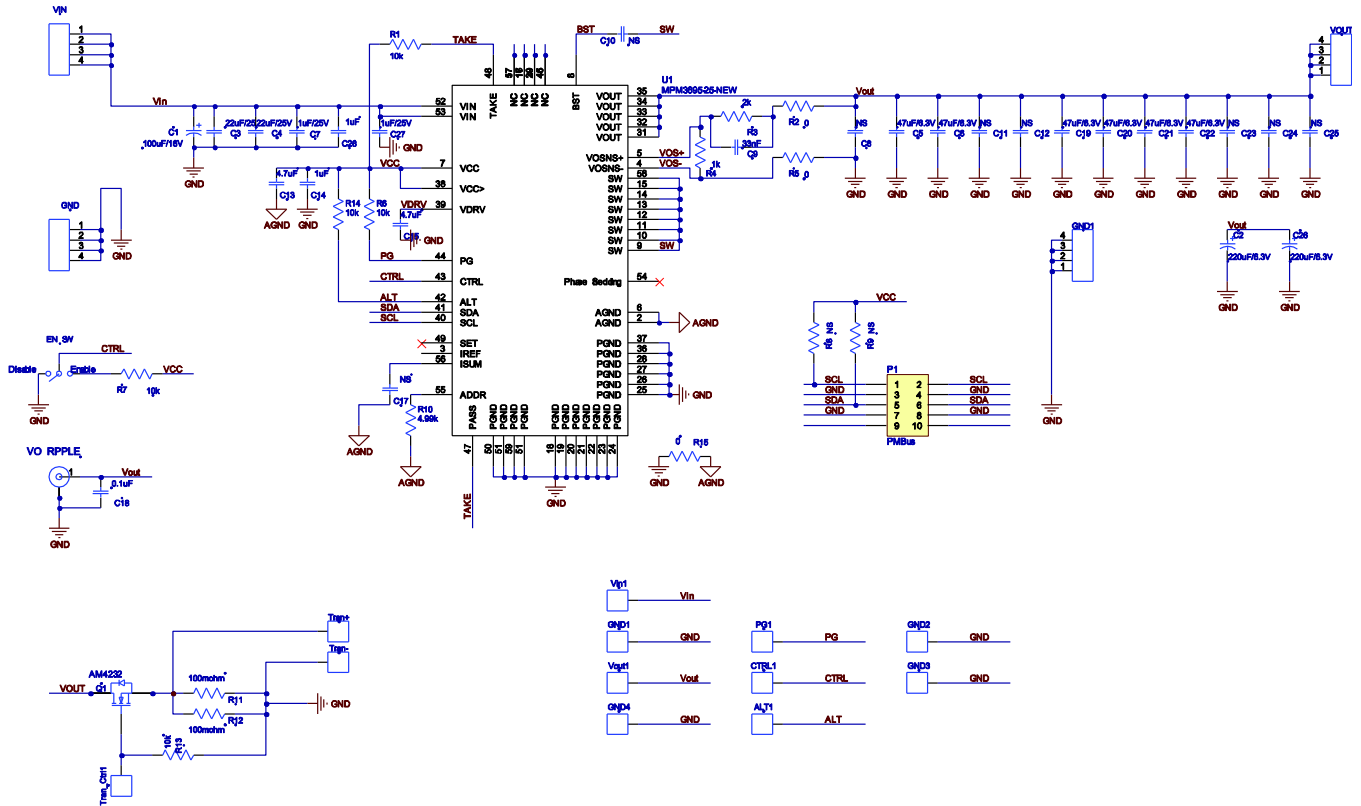

Vin=12V, Vout=1.8V@20A

EVM3695-25-RF-02A BOM

Qty	RefDes	Value	Description	Package	Manufacturer	Manufacturer_P/N
2	C3,C4	22 μ F	Ceramic Cap., 25V,X7R	1210	Murata	GRM32ER71E226KE15L
2	C7,C27	1 μ F	Ceramic Cap., 25V,X5R	0402	Murata	GRM155R61E105KA12D
2	C28,C14	1 μ F	Ceramic Cap., 25V,X7R	0603	Murata	GRM188R71E105KA12D
2	C13,C15	4.7 μ F	Ceramic Cap., 25V,X5R	0603	Murata	GRM188R61E475KE11D
1	C18	100nF	Ceramic Cap., 25V,X7R	0603	Murata	GRM188R71E104KA01D
1	C9	33nF	Ceramic Cap., 25V,X7R	0603	Murata	GRM188R71E333KA01D
6	C5.C6. C19.C20. C21.C22	47 μ F	Ceramic Cap., 6.3V,X5R	1206	Murata	GRM31CR60J476ME19L
2	C2.C26	220 μ F	Tantalum cap., 6.3V	D2	Panasonic	EEFCX0J221R
1	C1	100 μ F	100 μ F/35V	SMD	NIPPON CHEMI-CON	EMZJ350ADA101MF80G
5	R1.R6 R14.R7. R13	10k	Film Res,1%, 0603,10K	0603	YAGEO	RC0603FR-0710KL
1	R10	4K99	Film Res,1%, 0603,4K99	0603	YAGEO	RC0603FR-074K99L
3	R2.R5. R15	0R	Film Res,1%, 0603,0R	0603	YAGEO	RC0603FR-070RL
1	R3	2k	Film Res,1%, 0603,2K	0603	YAGEO	RC0603FR-072KL
1	R4	1k	Film Res,1%, 0603,1K	0603	YAGEO	RC0603FR-071KL
4	VIN,GND	N/A	N/A	N/A	Keystone	KEYSTONE7697-75
6	ALT	ϕ 1.0	ϕ 1.0 copper pin	DIP	N/A	ϕ 1.0 copper pin
1	Vo Ripple	N/A	4pin	DIP	N/A	SMA 射频座
1	CN6	SWITCH	Tact Switch, push type,white actuator	SMD	WE	450301014042
1	P1		10pin 双排直插 针			
1	U1	MPM3695-25	20A power module	QFN	MPS	MPM3695GRF-25-0022
2	R11. R12	0R1	Film Res,1%, 2512,0R1	2512	YAGEO	RC2512FR-070R1L
1	Q1	N-MOS	20A MOSFET	D-PARK2	Analog	AM4342N

TYPICAL PERFORMANCE CHARACTERISTICS

$V_{IN} = 12V$, $V_{OUT} = 1.8V$, $T_A = 25^\circ C$, unless otherwise noted.

Efficiency vs. Current Load

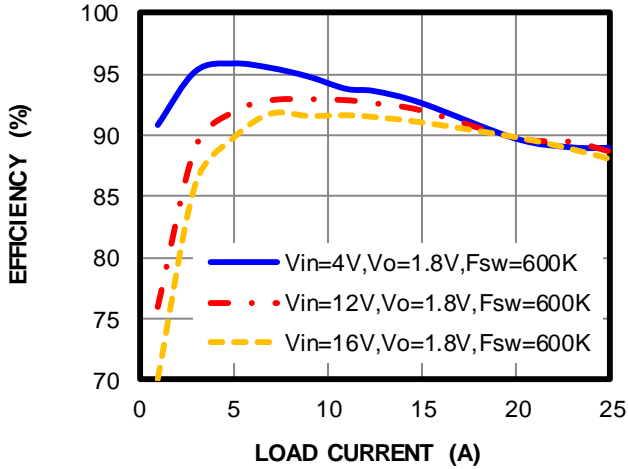

Power Loss vs. Load Current

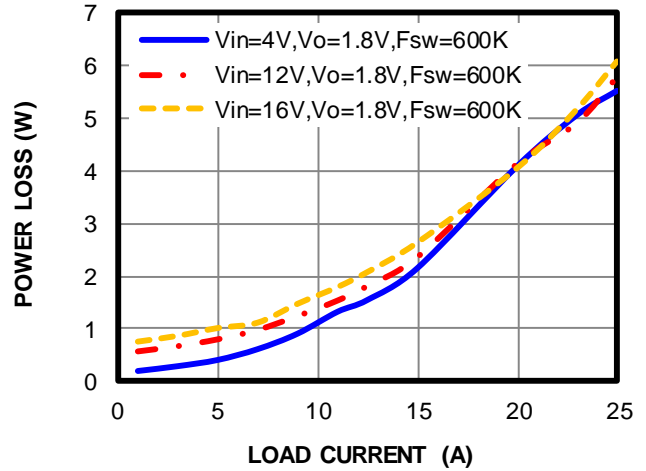

Regulation vs. Load Current

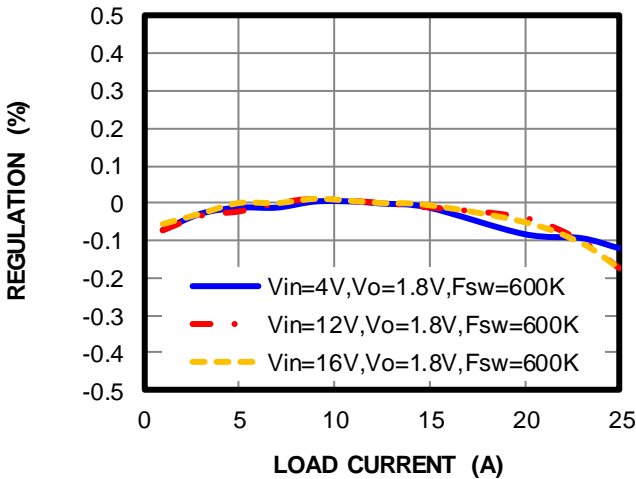

Thermal De-rating vs. Ambient Temp@200LFM Air Flow

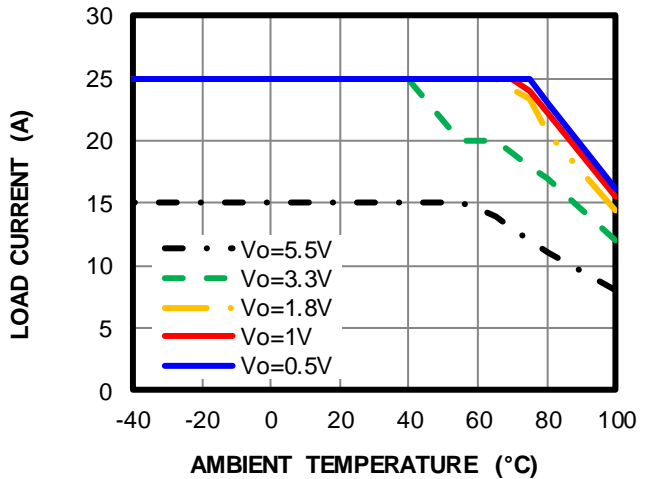

TYPICAL PERFORMANCE CHARACTERISTICS (Continued)
 $V_{IN} = 12V, V_{OUT} = 1.8V, I_o = 20A, T_A = 25^\circ C$, unless otherwise noted.

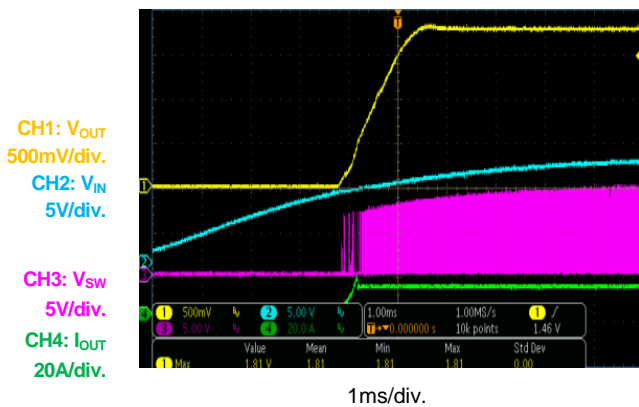
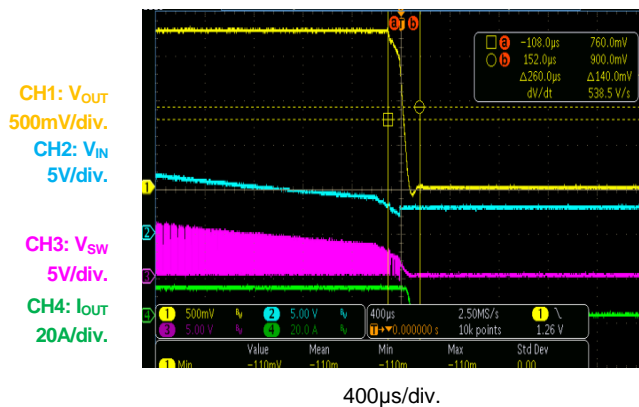
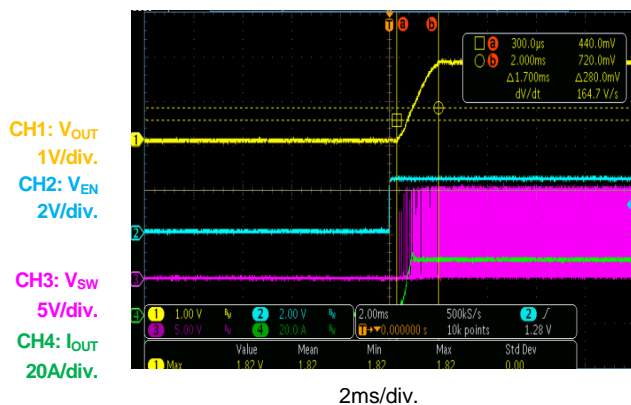
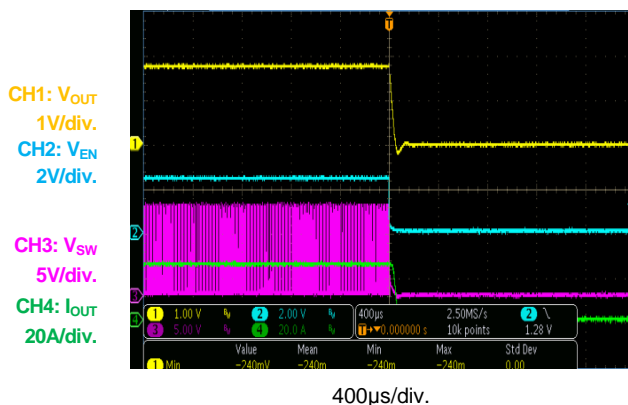
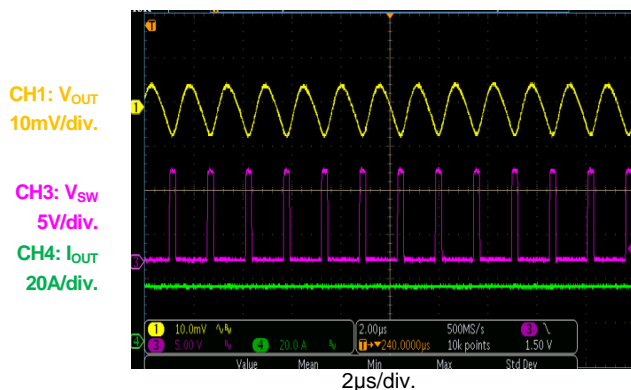
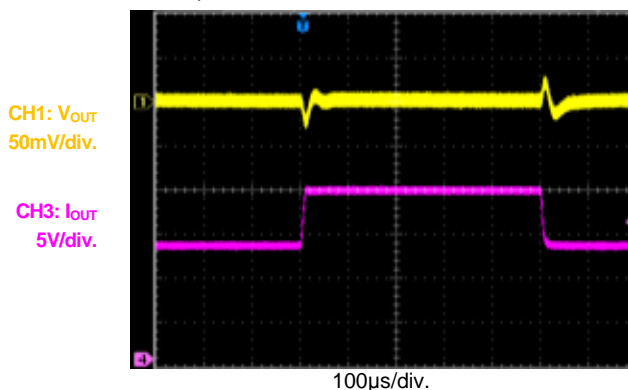
VIN Start-Up

VIN Shutdown

EN Start-Up

EN Shutdown

VOUT Ripple@VIN=12V, IO=20A

Load Transient@25% to 50% Load, 2.5A/us

EVM3695-25-RF-02A PCB LAYOUT

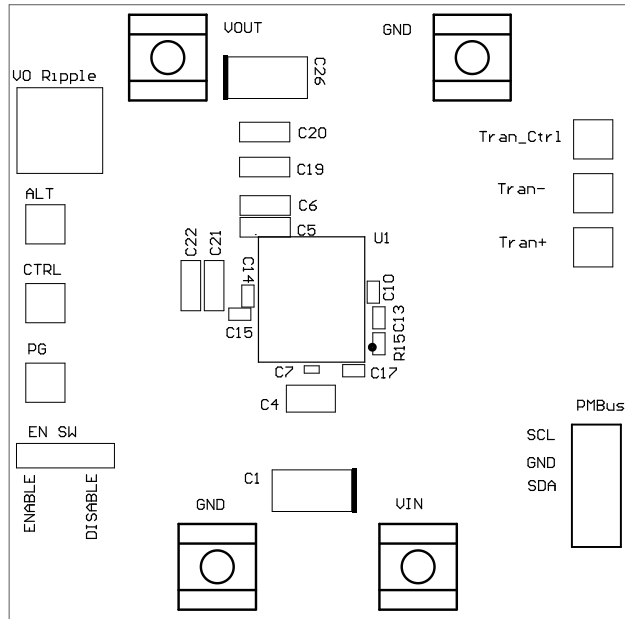

Figure 1-Top Silk Layer

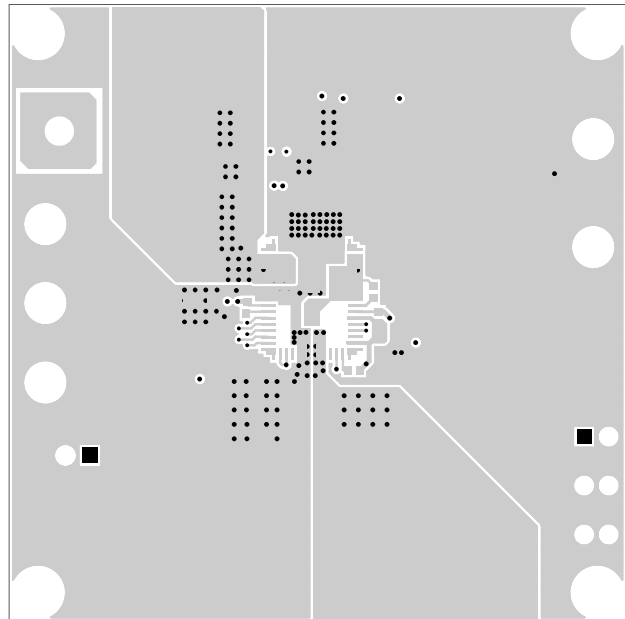

Figure 2-Top Layer

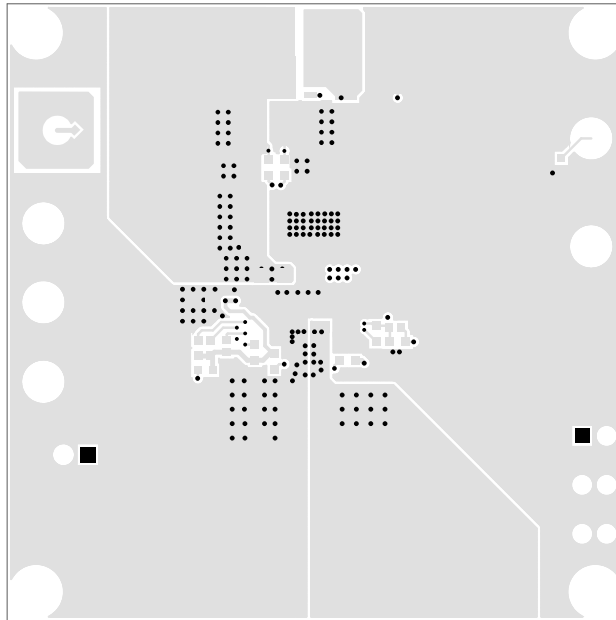

Figure 3-Bottom Layer

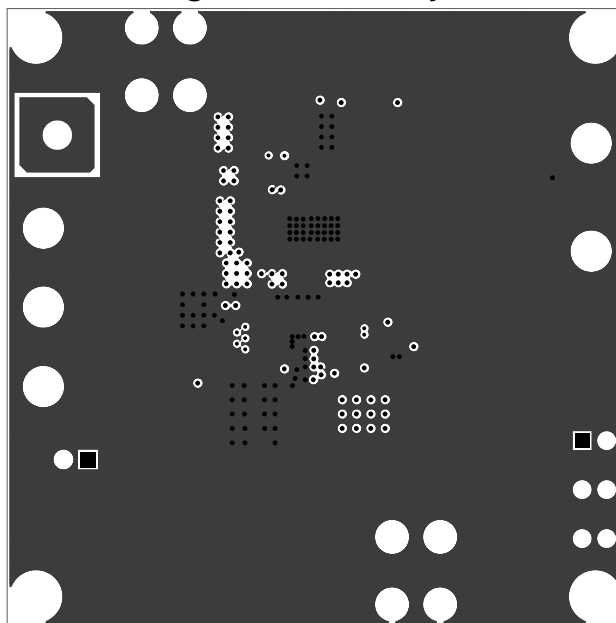

Figure 4-Inner1 Layer

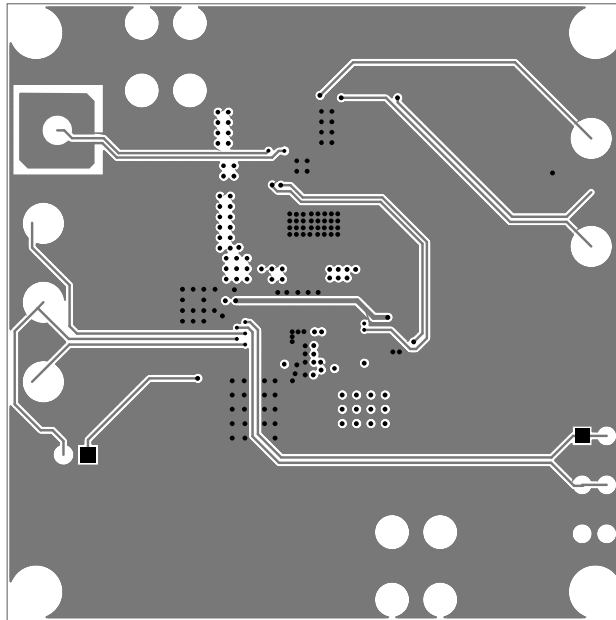

Figure 5- Inner2 Layer

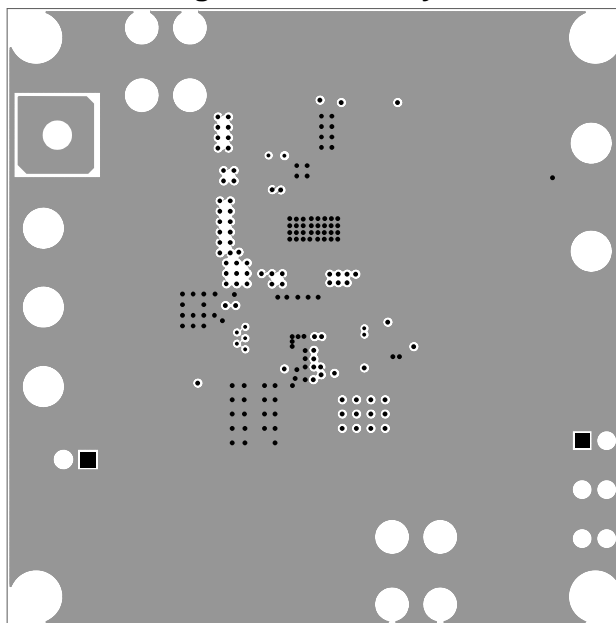

Figure 6- Inner3 Layer

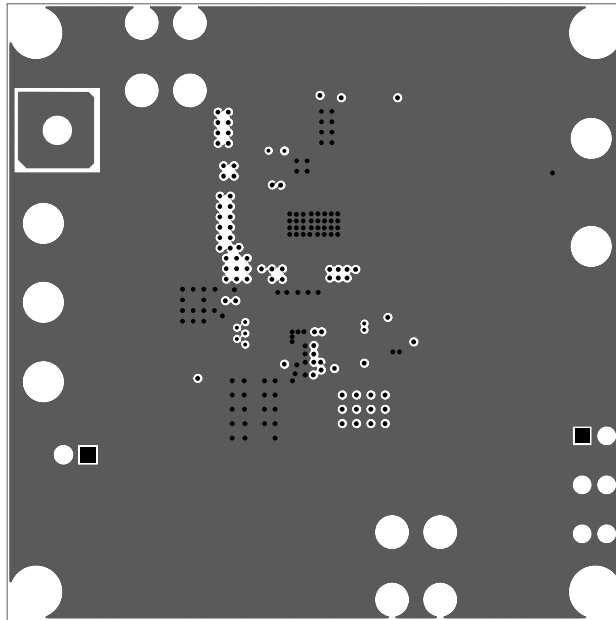

Figure 7-Inner4 Layer

QUICK START:

1. Connect the positive and negative terminals of the load to the VOUT and GND pins, respectively.
2. Preset the power supply output between 4V and 16V, and then turn off the power supply.
3. Connect the positive and negative terminals of the power supply output to the VIN and GND pins, respectively.
4. Turn the power supply on. The board will automatically start up. Figure 1-Top Silk Layer
5. MPM3695-25 GUI Simple Guide:
 - a. Check completeness for the PMBus tools:

ITEM	PN	QUANTITY
EVB	EVM3695-25-RF-02A	1
PMBus Kit	EVKT-USBI2C-02	1
USB Cable	\	1
PMBus Wire	\	1

- b. Connect PMBus wires to EVB and click the 'Virtual Bench Pro.exe', GUI will auto scan device:

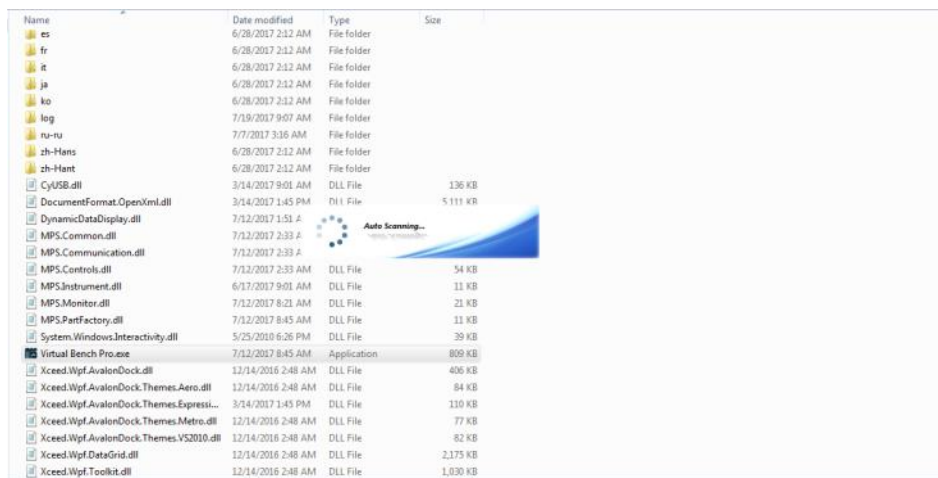
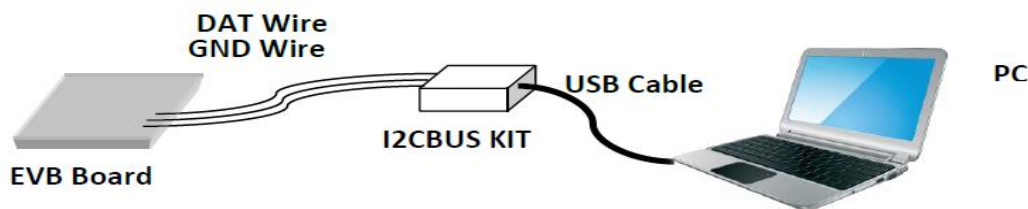

- c. When the part is found, the PN will be shown. The GUI allow user modify the internal parameters; please refer to the register details in IC datasheet.

On the right side, user can read the VOUT, IOUT, Temperature and other parameters.

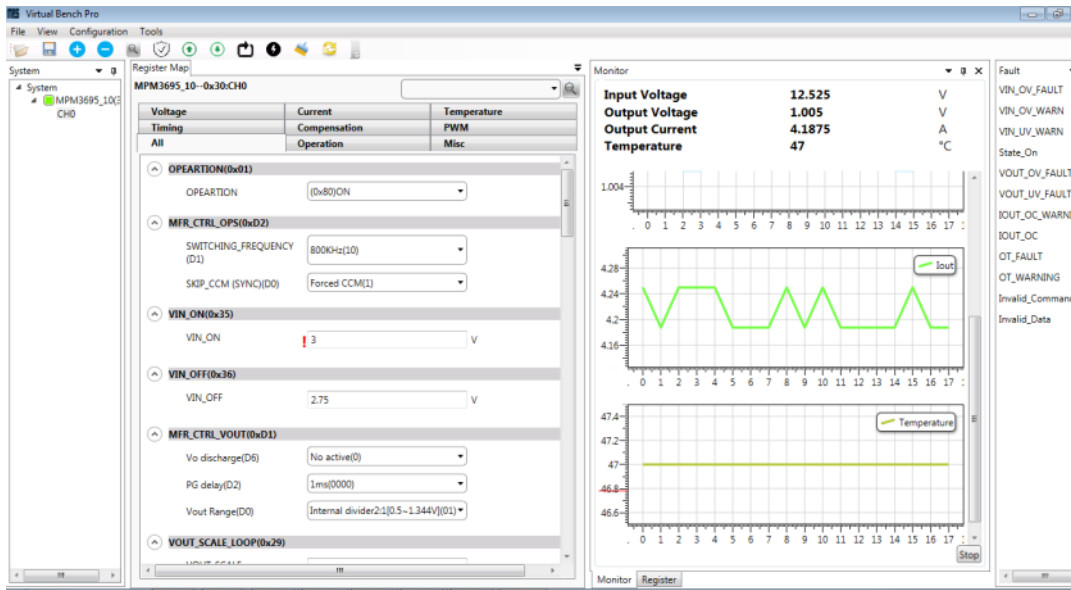

6. For different Output Voltage, recommended FB divider and PMBus parameters below:

Recommended Vo Range(V)	R3	R4	Vout_scale	Ramp	Cff	Fsw
0.5~1	500ohm	500ohm	0.5	44.7mV	33nF	600k
1~1.8	2k	1k	0.335	44.7mV	33nF	600k
1.8~2.4	3k	1k	0.25	44.7mV	33nF	600k
2.4~4	6.98k	1k	0.125	44.7mV	33nF	600k
4~6	9.09k	1k	0.1	44.7mV	33nF	600k

NOTICE: The information in this document is subject to change without notice. Users should warrant and guarantee that third party Intellectual Property rights are not infringed upon when integrating MPS products into any application. MPS will not assume any legal responsibility for any said applications.



Компания «ЭлектроПласт» предлагает заключение долгосрочных отношений при поставках импортных электронных компонентов на взаимовыгодных условиях!

Наши преимущества:

- Оперативные поставки широкого спектра электронных компонентов отечественного и импортного производства напрямую от производителей и с крупнейших мировых складов;
- Поставка более 17-ти миллионов наименований электронных компонентов;
- Поставка сложных, дефицитных, либо снятых с производства позиций;
- Оперативные сроки поставки под заказ (от 5 рабочих дней);
- Экспресс доставка в любую точку России;
- Техническая поддержка проекта, помощь в подборе аналогов, поставка прототипов;
- Система менеджмента качества сертифицирована по Международному стандарту ISO 9001;
- Лицензия ФСБ на осуществление работ с использованием сведений, составляющих государственную тайну;
- Поставка специализированных компонентов (Xilinx, Altera, Analog Devices, Intersil, Interpoint, Microsemi, Aeroflex, Peregrine, Syfer, Eurofarad, Texas Instrument, Miteq, Cobham, E2V, MA-COM, Hittite, Mini-Circuits, General Dynamics и др.);

Помимо этого, одним из направлений компании «ЭлектроПласт» является направление «Источники питания». Мы предлагаем Вам помощь Конструкторского отдела:

- Подбор оптимального решения, техническое обоснование при выборе компонента;
- Подбор аналогов;
- Консультации по применению компонента;
- Поставка образцов и прототипов;
- Техническая поддержка проекта;
- Защита от снятия компонента с производства.



Как с нами связаться

Телефон: 8 (812) 309 58 32 (многоканальный)

Факс: 8 (812) 320-02-42

Электронная почта: org@eplast1.ru

Адрес: 198099, г. Санкт-Петербург, ул. Калинина, дом 2, корпус 4, литера А.