



## Features

- Compact design, long life and high reliability
- Momentary push switch option
- Available in a wide variety of configurations to meet many user requirements



## PEC12R - 12 mm Incremental Encoder

### Electrical Characteristics

Output .....	2-bit quadrature code
Contact Rating .....	10 mA @ 5 VDC
Insulation Resistance .....	10 megohms @ 250 VDC
Dielectric Withstanding Voltage	
Sea Level .....	50 VAC minimum
Electrical Travel .....	Continuous
Contact Bounce (15 RPM) .....	2.0 ms. maximum**
RPM (Operating) .....	100 maximum**

### Environmental Characteristics

Operating Temperature Range .....	-30 °C to +70 °C (-22 °F to +158 °F)
Storage Temperature Range .....	-40 °C to +85 °C (-40 °F to +185 °F)
Humidity .....	MIL-STD-202, Method 103B, Condition B
Vibration .....	10~55~10 Hz / 1 min. / Amplitude 1.5 mm
Shock .....	100 G
Rotational Life .....	30,000 cycles minimum
Switch Life .....	20,000 cycles minimum
IP Rating .....	IP 40

### Mechanical Characteristics

Mechanical Angle .....	360 ° continuous
Torque	
Running .....	30.6 to 204 g-cm (0.42 to 2.83 oz.-in.)
Mounting .....	10.2 kgf.cm (8.83 lb.-in.) maximum
Shaft Side Load (Static) .....	2.04 kgf (4.5 lbs.) minimum
Weight .....	3 gm (0.1 oz.) maximum
Terminals .....	Printed circuit board terminals
Terminals .....	Printed circuit board terminals
Soldering Condition	
Wave Soldering .....	Sn95.5/Ag2.8/Cu0.7 solder with no-clean flux: 260 °C max. for 3 ± 1 sec.
Hand Soldering .....	Not recommended
Hardware .....	One flat washer and one mounting nut supplied with each encoder with bushing

### Switch Characteristics

Switch Type .....	Contact Push ON Momentary SPST
Power Rating (Resistive Load) .....	10 mA at 5 V DC
Switch Travel .....	0.5 ± 0.3 mm
Switch Actuation Force .....	610 ± 306 gf (8.47 ± 4.24 oz.-in.)
Contact Resistance .....	100 milliohms @ 5 VDC

### How To Order

**PEC12R - 4 0 20 F - S 0012**

Model .....	PEC12R - 4 0 20 F - S 0012
Terminal/Bushing Configuration .....	4 = Horizontal Mount - Axial PC Pin/No Bushing
	2 = Vertical Mount - Radial PC Pin/No Bushing
	3 = Horizontal Mount - Axial PC Pin/with Bushing
Detent Option .....	0 = No Detents
	1 = 12 Detents (available with 12 pulses only)
	2 = 24 Detents
Standard Shaft Length .....	22 = 22.5 mm
	17 = 17.5 mm
	20 = 20.0 mm
	25 = 25.0 mm
	30 = 30.0 mm
Shaft Style .....	F = Insulated Flatted Shaft
Switch Configuration .....	S = Push Momentary Switch
	N = No Switch
Resolution .....	0012 = 12 Pulses per 360 ° Rotation
	0024 = 24 Pulses per 360 ° Rotation

### Quadrature Output Table

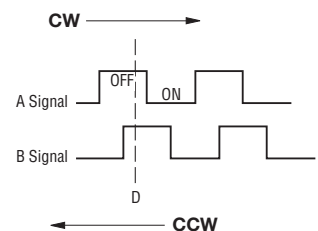

\*RoHS Directive 2002/95/EC Jan. 27, 2003 including annex and RoHS Recast 2011/65/EU June 8, 2011.

\*\*Devices are tested using standard noise reduction filters. For optimum performance, designers should use noise reduction filters in their circuits. Specifications are subject to change without notice.

The device characteristics and parameters in this data sheet can and do vary in different applications and actual device performance may vary over time. Users should verify actual device performance in their specific applications.

# Applications

Level control, tuning and timer settings in:

- Audio-visual equipment
- Consumer electric appliances
- Musical instrumentation
- Communications equipment

## PEC12R - 12 mm Incremental Encoder



### Product Dimensions

#### PEC12R-2xxxF-Nxxxx (Vertical Mount - Radial PC Pin/No Bushing, No Switch)

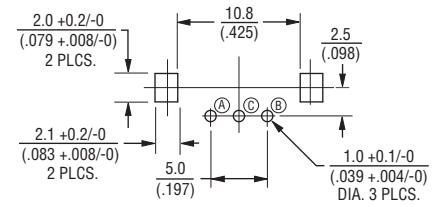
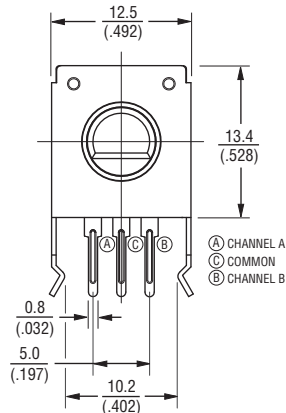
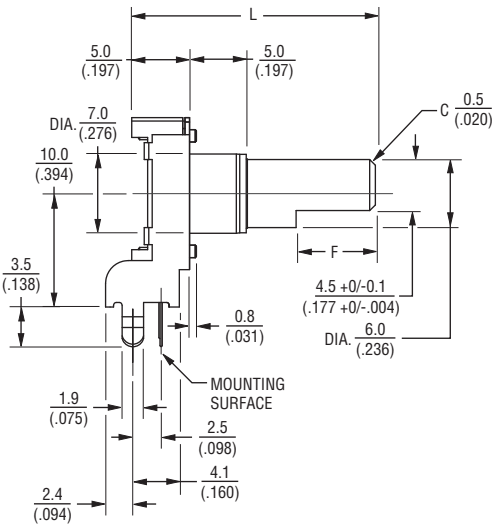

#### PEC12R-2xxxF-Sxxxx (Vertical Mount - Radial PC Pin/No Bushing, Push Momentary Switch)

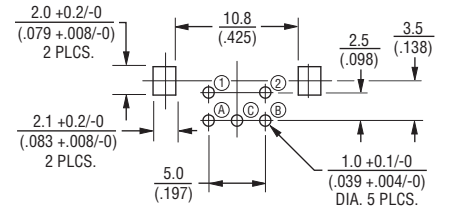
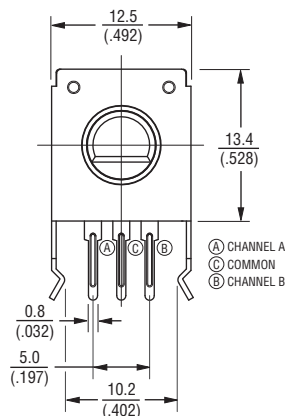
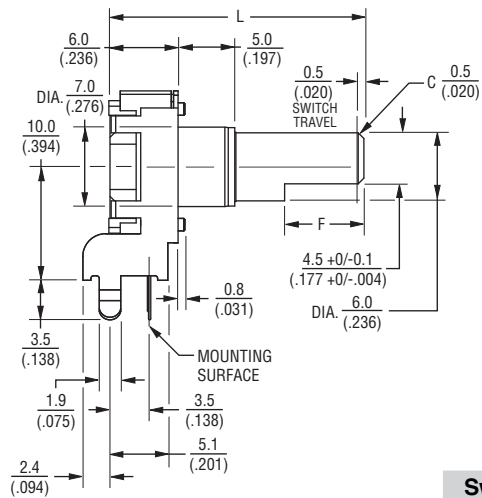

### Switch Circuit



### Suggested Filter Circuit

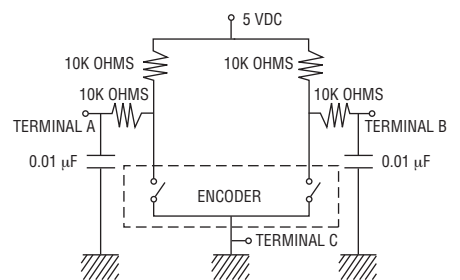

L	17.5 (.688)	20.0 (.787)	22.5 (.886)	25.0 (.984)	30.0 (1.181)
F	5.0 (.197)	7.0 (.276)	7.0 (.276)	12.0 (.472)	12.0 (.472)

DIMENSIONS:  $\frac{\text{MM}}{\text{(INCHES)}}$

TOLERANCE:  $\frac{<10}{(<.400)} = \frac{\pm 0.3}{(\pm .012)}$   
 $\frac{\geq 10}{(\geq .400)} = \frac{\pm 0.5}{(\pm .020)}$

The device characteristics and parameters in this data sheet can and do vary in different applications and actual device performance may vary over time. Users should verify actual device performance in their specific applications.

Specifications are subject to change without notice.

# PEC12R - 12 mm Incremental Encoder

**BOURNS®**

## Product Dimensions

### PEC12R-3xxxF-Nxxxx (Horizontal Mount - Axial PC Pin/with Bushing, No Switch)



### PEC12R-3xxxF-Sxxxx (Horizontal Mount - Axial PC Pin/with Bushing, Push Momentary Switch)



L	$\frac{17.5}{(.688)}$	$\frac{20.0}{(.787)}$	$\frac{22.5}{(.886)}$	$\frac{25.0}{(.984)}$	$\frac{30.0}{(1.181)}$
LB	$\frac{5.0}{(.197)}$	$\frac{5.0}{(.197)}$	$\frac{7.0}{(.276)}$	$\frac{7.0}{(.276)}$	$\frac{7.0}{(.276)}$
F	$\frac{5.0}{(.197)}$	$\frac{7.0}{(.276)}$	$\frac{7.0}{(.276)}$	$\frac{12.0}{(.472)}$	$\frac{12.0}{(.472)}$

DIMENSIONS:  $\frac{\text{MM}}{\text{(INCHES)}}$

TOLERANCE:  $\frac{<10}{(<.400)} = \frac{\pm 0.3}{(\pm .012)}$

$\frac{\geq 10}{(\geq .400)} = \frac{\pm 0.5}{(\pm .020)}$

Specifications are subject to change without notice.

The device characteristics and parameters in this data sheet can and do vary in different applications and actual device performance may vary over time. Users should verify actual device performance in their specific applications.

# PEC12R - 12 mm Incremental Encoder

**BOURNS®**

## Product Dimensions

### PEC12R-4xxxF-Nxxxx (Horizontal Mount - Axial PC Pin/No Bushing, No Switch)



### PEC12R-4xxxF-Sxxxx (Horizontal Mount - Axial PC Pin/No Bushing, Push Momentary Switch)



L	15.0 (.591)	17.5 (.688)	20.0 (.787)	22.5 (.886)	25.0 (.984)	30.0 (1.181)
LB	2.0 (.079)	5.0 (.197)	5.0 (.197)	5.0 (.197)	5.0 (.197)	5.0 (.197)
F	5.0 (.197)	5.0 (.197)	7.0 (.276)	7.0 (.276)	12.0 (.472)	12.0 (.472)

DIMENSIONS:	MM (INCHES)
TOLERANCE:	<10 (<.400) = ±0.3 (±.012)
	≥10 (≥.400) = ±0.5 (±.020)

**BOURNS®**

**Asia-Pacific:**  
Tel: +886-2 2562-4117  
Fax: +886-2 2562-4116

**EMEA:**  
Tel: +36 88 520 390  
Fax: +36 88 520 211

**The Americas:**  
Tel: +1-951 781-5500  
Fax: +1-951 781-5700

[www.bourns.com](http://www.bourns.com)

REV. 04/15

Specifications are subject to change without notice.

The device characteristics and parameters in this data sheet can and do vary in different applications and actual device performance may vary over time.

Users should verify actual device performance in their specific applications.



Компания «ЭлектроПласт» предлагает заключение долгосрочных отношений при поставках импортных электронных компонентов на взаимовыгодных условиях!

Наши преимущества:

- Оперативные поставки широкого спектра электронных компонентов отечественного и импортного производства напрямую от производителей и с крупнейших мировых складов;
- Поставка более 17-ти миллионов наименований электронных компонентов;
- Поставка сложных, дефицитных, либо снятых с производства позиций;
- Оперативные сроки поставки под заказ (от 5 рабочих дней);
- Экспресс доставка в любую точку России;
- Техническая поддержка проекта, помощь в подборе аналогов, поставка прототипов;
- Система менеджмента качества сертифицирована по Международному стандарту ISO 9001;
- Лицензия ФСБ на осуществление работ с использованием сведений, составляющих государственную тайну;
- Поставка специализированных компонентов (Xilinx, Altera, Analog Devices, Intersil, Interpoint, Microsemi, Aeroflex, Peregrine, Syfer, Eurofarad, Texas Instrument, Miteq, Cobham, E2V, MA-COM, Hittite, Mini-Circuits, General Dynamics и др.);

Помимо этого, одним из направлений компании «ЭлектроПласт» является направление «Источники питания». Мы предлагаем Вам помощь Конструкторского отдела:

- Подбор оптимального решения, техническое обоснование при выборе компонента;
- Подбор аналогов;
- Консультации по применению компонента;
- Поставка образцов и прототипов;
- Техническая поддержка проекта;
- Защита от снятия компонента с производства.



#### Как с нами связаться

**Телефон:** 8 (812) 309 58 32 (многоканальный)

**Факс:** 8 (812) 320-02-42

**Электронная почта:** [org@eplast1.ru](mailto:org@eplast1.ru)

**Адрес:** 198099, г. Санкт-Петербург, ул. Калинина, дом 2, корпус 4, литера А.