

IEC Appliance Inlet C14 or C18, sandwich Mounting, PCB- or Solder Terminal



Snap-in version
 Sandwich/rear-side
 PCB Mounting

IEC connector C14 or C18
 Screw-on mounting
 PCB Mounting



See below:

[Approvals and Compliances](#)

Description

- Panel mount :
- Snap-in or screw-on mounting on PCB , sandwich or rear-side
- Appliance Inlet , Pin temperature 70 °C , protection class I or II
- V-Lock notch standard
- For PCB mounting

Other versions on request

- With solder terminals angled or parallel to pin axis

Weblinks

[pdf data sheet](#), [html datasheet](#), [General Product Information](#), [Approvals](#), [Distributor-Stock-Check](#), [Accessories](#), [Detailed request for product](#), [Landing Page](#)

Technical Data

| | | | |
|-----------------------------------|---|-------------------------|---|
| Ratings IEC | 10A / 250VAC; 50Hz | Appliance inlet/-outlet | C14 / C18 acc. to IEC 60320-1, UL 60320-1, CSA C22.2 no. 60320-1 (for cold conditions) pin-temperature 70 °C, 10A, Protection Class I or II |
| Ratings UL/CSA | 15A / 250VAC; 60Hz | | |
| Dielectric Strength | > 3 kVAC between L-N > 3 kVAC between L/N-PE (1 min/50Hz) | | |
| Allowable Operation Temperature | -25 °C to 70 °C | | |
| IP-Protection | from front side IP40 acc. to IEC 60529 | | |
| Protection against electric shock | Suitable for appliances with protection class I or II acc. to IEC 61140 | | |
| Terminal | For PCB mounting : Ground terminal: angled to pin axis | | |
| Panel Thickness S | Sandwich/rear-side: 1.5/2/2.5/3 mm | | |
| Material: Housing | Thermoplastic, black, UL 94V-0 | | |

Approvals and Compliances

Detailed information on product approvals, code requirements, usage instructions and detailed test conditions can be looked up in [Details about Approvals](#)

SCHURTER products are designed for use in industrial environments. They have approvals from independent testing bodies according to national and international standards. Products with specific characteristics and requirements such as required in the automotive sector according to IATF 16949, medical technology according to ISO 13485 or in the aerospace industry can be offered exclusively with customer-specific, individual agreements by SCHURTER.

Approvals



The approval mark is used by the testing authorities to certify compliance with the safety requirements placed on electronic products.

Approval Reference Type: GSP2

| Approval Logo | Certificates | Certification Body | Description |
|---------------|-------------------------------|--------------------|--|
| | VDE Approvals | VDE | Certificate Number: 40012767 |
| | UL Approvals | UL | UL File Number: E96454 |
| | CCC Approvals | CCC | CCC Certificate Number: 2006010204183838 |

Product standards

Product standards that are referenced

| Organization | Design | Standard | Description |
|--|-----------------------|-----------------------|---|
|  | Designed according to | IEC 60320-1 | Appliance couplers for household and similar general purposes |
|  | Designed according to | UL 60320-1 | Standard for Attachment Plugs and Receptacles |
|  | Designed according to | CSA C22.2 no. 60320-1 | General Use Receptacles, Attachment Plugs, and Similar Wiring Devices |







Application standards

Application standards where the product can be used

| Organization | Design | Standard | Description |
|--|--------------------------------|----------------|--|
|  | Designed for applications acc. | IEC/UL 62368-1 | IEC 62368-1 includes the basic requirements for safety of audio, video, information technology and office equipment. |
|  | Designed for applications acc. | IEC 60335-1 | Safety of electrical appliances for household and similar purposes. Meets the requirements for appliances in unattended use. This includes the enhanced requirements of glow wire tests acc. to IEC 60695-2-11 or -12 & -13. |

Compliances

The product complies with following Guide Lines

| Identification | Details | Initiator | Description |
|--|--|-------------|--|
|  | CE declaration of conformity | SCHURTER AG | The CE marking declares that the product complies with the applicable requirements laid down in the harmonisation of Community legislation on its affixing in accordance with EU Regulation 765/2008. |
|  | RoHS | SCHURTER AG | Directive RoHS 2011/65/EU, Amendment (EU) 2015/863 |
|  | China RoHS | SCHURTER AG | The law SJ / T 11363-2006 (China RoHS) has been in force since 1 March 2007. It is similar to the EU directive RoHS. |
|  | REACH | SCHURTER AG | On 1 June 2007, Regulation (EC) No 1907/2006 on the Registration, Evaluation, Authorization and Restriction of Chemicals 1 (abbreviated as "REACH") entered into force. |
|  | Landing Page V-Lock | SCHURTER AG | V-Lock system are based on a matching plug-dose combination. The connector is equipped with a notch intended for use with the latching cordset. The cord latching system prevents against accidental removal of the cordset. |
|  | White Paper Glow wire test | SCHURTER AG | Meets the requirements of IEC 60335-1 for appliances in unattended use. This includes the enhanced requirements of glow wire tests acc. to IEC 60695-2-11 or -12 &-13. |

Dimensions [mm]

Snap-in mounting



Screw-on mounting

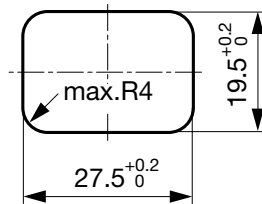
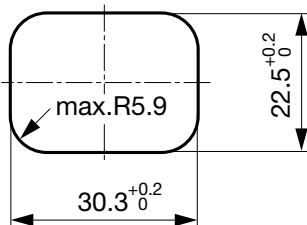
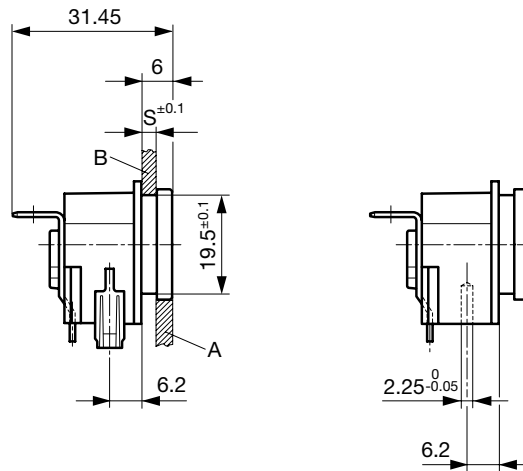

Rear panel mounting

Sandwich mounting

Drilling diagrams

Drilling diagram

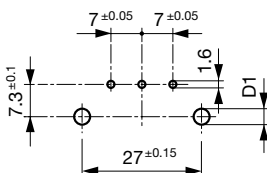

d1 = 6 ± 0.05 for Snap-in mounting
 d1 = 3.6 ± 0.05 for screw-on mounting
 with self-tapping screws
 3 mm (EJOT-PT), 2 screws enclosed

All Variants

| Protection Class | PCB mounting | Panel Thickness s [mm] | Ground terminal 4.8 x 0.8 mm | Cover | Order Number |
|------------------|--------------|---------------------------|------------------------------|-------|--------------|
| I | Snap-in | 1.5 | angled to pin axis | | GSP2.9205.13 |
| I | Snap-in | 1.5 | angled to pin axis | | GSP2.9901.13 |
| I | Snap-in | 1 | straight | | GSP2.9203.11 |
| I | Snap-in | 1.2 | straight | | GSP2.9203.12 |
| I | Snap-in | 1.5 | straight | | GSP2.9203.13 |
| I | Snap-in | 1.5 | straight | | GSP2.9903.13 |
| I | Snap-in | 2 | straight | | GSP2.9203.14 |
| I | Snap-in | 2.5 | straight | | GSP2.9203.15 |
| I | Snap-in | 3 | straight | | GSP2.9203.16 |
| I | Snap-in | 1.5 | straight | ● | GSP2.9213.13 |
| I | Snap-in | 2 | straight | ● | GSP2.9213.14 |
| I | Snap-in | 2.5 | straight | ● | GSP2.9213.15 |

| Protection Class | PCB mounting | Panel Thickness s [mm] | Ground terminal 4.8 x 0.8 mm | Cover | Order Number |
|------------------|--------------|------------------------|------------------------------|-------|--------------|
| I | Snap-in | 3 | straight | ● | GSP2.9213.16 |
| I | Screw | 1 | straight | | GSP2.9103.11 |
| I | Screw | 1.5 | straight | | GSP2.9103.13 |
| I | Screw | 2 | straight | | GSP2.9103.14 |
| I | Screw | 2.5 | straight | | GSP2.9103.15 |
| I | Screw | 3 | straight | | GSP2.9103.16 |
| I | Screw | 1.5 | straight | ● | GSP2.9113.13 |
| I | Screw | 2 | straight | ● | GSP2.9113.14 |
| I | Screw | 2.5 | straight | ● | GSP2.9113.15 |
| I | Screw | 3 | straight | ● | GSP2.9113.16 |
| II | Snap-in | 1.5 | - | | GSP2.9200.13 |
| II | Snap-in | 2.5 | - | | GSP2.9200.15 |
| II | Snap-in | 1.5 | - | ● | GSP2.9210.13 |
| II | Snap-in | 2 | - | ● | GSP2.9210.14 |
| II | Snap-in | 2.5 | - | ● | GSP2.9210.15 |
| II | Snap-in | 3 | - | ● | GSP2.9210.16 |
| II | Screw | 1.5 | - | | GSP2.9100.13 |
| II | Screw | 3 | - | | GSP2.9100.16 |
| II | Screw | 2 | - | ● | GSP2.9110.14 |
| II | Screw | 2.5 | - | ● | GSP2.9110.15 |

Most Popular.

Availability for all products can be searched real-time: <https://www.schurter.com/en/Stock-Check/Stock-Check-SCHURTER>

Additional version on request, e.g.: Ground terminal straight or quick-connect terminal 6,3 x 0,8 mm

Packaging unit 50 Pcs

Mating Outlets/Connectors

Category / Description

Connector Overview complete



| | |
|---|---------|
| 4782 Mounting: Power Cord, 3 x 1 mm ² / 3 x 18 AWG, Cable, Connector: IEC C13 | 4782 |
| 4785 Mounting: Power Cord, 3 x 1 mm ² / 3 x 18 AWG, Cable, Connector: IEC C13 | 4785 |
| 4012 Mounting: Power Supply Cord, 3 x 1 mm ² , Screw clamps, Connector: IEC C13 | 4012 |
| 4300-06 Mounting: Power Cord, 3 x 1 mm ² / 3 x 18 AWG, Cable, Connector: IEC C13 | 4300-06 |
| 4781 Mounting: Power Cord, 3 x 1 mm ² / 3 x 18 AWG, Cable, Connector: IEC C15 | 4781 |

[Connector further types to GSP2](#) ...

Interconnection Cord Overview complete



| | |
|--|-----------|
| Cord Sets 10 A, Interconnection, 2.0 m, IEC H05VV-F3G1.0, black | 6007.0204 |
| Cord Sets 10 A, Interconnection, 1.0 m, Connector IEC C13, H05VV-F3G1.0, black | 6007.0212 |
| Cord Sets 10 A, Interconnection, 2.0 m, Connector IEC C13, H05VV-F3G1.0, black | 6007.0214 |

[Interconnection Cord further types to GSP2](#)

Power Supply Cord Overview complete



| | |
|--|-----------|
| Cord Sets 10 A, Europlug, 2.5 m, Connector IEC C13, H05VV-F3G1.0, black | 6004.0215 |
| Cord Sets 10 A, Europlug, 2.5 m, Connector IEC C13, H05VV-F3G1.0, black | 6003.0215 |
| Cord Sets 10 A, uninsulated wires, 2.0 m, Connector IEC C13, H05VV-F3G1.0, black | 6000.0224 |
| Cord Sets 10 A, uninsulated wires, 2.0 m, Connector IEC C13, H05VV-F3G1.0, black | 6000.0214 |
| Cord Sets 10 A, United Kingdom, 2.5 m, Connector IEC C13, H05VV-F3G1.0, black | 6044.0215 |

[Power Supply Cord further types to GSP2](#) ...

Category / Description



[Power Supply or Interconnection Cord Overview complete](#)

Cord Sets 10 A, United Kingdom, 2.0 m, Connector IEC H05VV-F3G1.0, black

6044.0204

[Power Supply or Interconnection Cord further types to GSP2](#)

Mating Outlets/Connectors shuttered



[Connector Overview complete](#)

4783 Mounting: Power Cord, 3 x 1 mm² / 3 x 18 AWG, Cable, Connector: IEC C13

4783

[Connector further types to GSP2](#)



[Power Cord Overview complete](#)

VAC13KS, Overview, V-Lock cord retaining, diverse Connector IEC C13, diverse, black

VAC13KS

VAC17KS, V-Lock cord retaining, diverse m, Connector IEC C17, diverse, black / grey / white

VAC17KS

[Power Cord further types to GSP2](#)



Компания «ЭлектроПласт» предлагает заключение долгосрочных отношений при поставках импортных электронных компонентов на взаимовыгодных условиях!

Наши преимущества:

- Оперативные поставки широкого спектра электронных компонентов отечественного и импортного производства напрямую от производителей и с крупнейших мировых складов;
- Поставка более 17-ти миллионов наименований электронных компонентов;
- Поставка сложных, дефицитных, либо снятых с производства позиций;
- Оперативные сроки поставки под заказ (от 5 рабочих дней);
- Экспресс доставка в любую точку России;
- Техническая поддержка проекта, помощь в подборе аналогов, поставка прототипов;
- Система менеджмента качества сертифицирована по Международному стандарту ISO 9001;
- Лицензия ФСБ на осуществление работ с использованием сведений, составляющих государственную тайну;
- Поставка специализированных компонентов (Xilinx, Altera, Analog Devices, Intersil, Interpoint, Microsemi, Aeroflex, Peregrine, Syfer, Eurofarad, Texas Instrument, Miteq, Cobham, E2V, MA-COM, Hittite, Mini-Circuits, General Dynamics и др.);

Помимо этого, одним из направлений компании «ЭлектроПласт» является направление «Источники питания». Мы предлагаем Вам помощь Конструкторского отдела:

- Подбор оптимального решения, техническое обоснование при выборе компонента;
- Подбор аналогов;
- Консультации по применению компонента;
- Поставка образцов и прототипов;
- Техническая поддержка проекта;
- Защита от снятия компонента с производства.



Как с нами связаться

Телефон: 8 (812) 309 58 32 (многоканальный)

Факс: 8 (812) 320-02-42

Электронная почта: org@eplast1.ru

Адрес: 198099, г. Санкт-Петербург, ул. Калинина, дом 2, корпус 4, литера А.