

20V PNP SILICON LOW SATURATION TRANSISTOR IN SOT23

Features and Benefits

- $BV_{CEO} > -20V$
- $I_C = -1A$ Continuous Collector Current
- $I_{CM} = -2A$ Peak Pulse Current
- Low Saturation Voltage $V_{CE(sat)} < -320mV @ -1A$
- h_{FE} characterised up to $-1.5A$ for high current gain hold-up
- 500mW power dissipation
- Complementary part number FMMTL618
- **Lead Free, RoHS Compliant (Note 1)**
- **Halogen and Antimony Free "Green" Device (Note 2)**
- **Qualified to AEC-Q101 Standards for High Reliability**

Mechanical Data

- Case: SOT-23
- UL Flammability Rating 94V-0
- Case material: molded Plastic.
- Moisture Sensitivity: Level 1 per J-STD-020D
- Terminals: Matte Tin Finish annealed over Copper plated Alloy 42 leadframe. Solderable per MIL-STD-202, Method 208
- Weight: 0.008 grams (Approximate)

Applications

- MOSFET Gate Driving
- DC-DC Converters
- Charging circuit
- Power switches

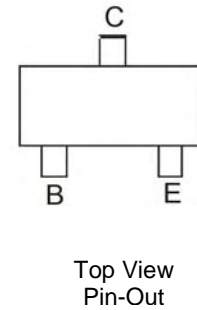
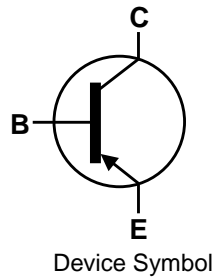

Ordering Information (Note 3)

Product	Marking	Reel size (inches)	Tape width (mm)	Quantity per reel
FMMTL718TA	L78	7	8	3,000

- Notes:
1. No purposefully added lead.
 2. Diodes Inc.'s "Green" Policy can be found on our website at <http://www.diodes.com>
 3. For Packaging Details, go to our website at <http://www.diodes.com>.

Marking Information

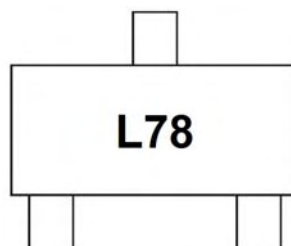

L78 = Product Type Marking Code

Maximum Ratings @ $T_A = 25^\circ\text{C}$ unless otherwise specified

Characteristic	Symbol	Value	Unit
Collector-Base Voltage	V_{CBO}	-20	V
Collector-Emitter Voltage	V_{CEO}	-20	V
Emitter-Base Voltage	V_{EBO}	-5	V
Continuous Collector Current	I_C	-1	A
Peak Pulse Current	I_{CM}	-2	A
Base Current	I_B	-200	mA

Thermal Characteristics @ $T_A = 25^\circ\text{C}$ unless otherwise specified

Characteristic	Symbol	Value	Unit
Power Dissipation (Note 4)	P_D	500	mW
Thermal Resistance, Junction to Ambient (Note 4)	$R_{\theta JA}$	250	$^\circ\text{C/W}$
Thermal Resistance, Junction to Lead (Note 5)	$R_{\theta JL}$	197	$^\circ\text{C/W}$
Operating and Storage Temperature Range	T_J, T_{STG}	-55 to +150	$^\circ\text{C}$

- Notes:
4. For a device surface mounted on 15mm X 15mm FR4 PCB with high coverage of single sided 1 oz copper, in still air conditions; the device is measured when operating in a steady-state condition.
 5. Thermal resistance from junction to solder-point (at the end of the collector lead).

Electrical Characteristics @ $T_A = 25^\circ\text{C}$ unless otherwise specified

Characteristic	Symbol	Min	Typ	Max	Unit	Test Condition
Collector-Base Breakdown Voltage	BV_{CBO}	-20	-65		V	$I_C = -100 \mu\text{A}$
Collector-Emitter Breakdown Voltage (Note 6)	BV_{CEO}	-20	-55		V	$I_C = -10 \text{ mA}$
Emitter-Base Breakdown Voltage	BV_{EBO}	-5	-8.8		V	$I_E = -100 \mu\text{A}$
Collector Cutoff Current	I_{CBO}			-10	nA	$V_{CB} = -15\text{V}$
Emitter Cutoff Current	I_{EBO}			-10	nA	$V_{EB} = -4\text{V}$
Collector Emitter Cutoff Current	I_{CES}			-10	nA	$V_{CE} = -15\text{V}$
Static Forward Current Transfer Ratio (Note 6)	h_{FE}	300 300 200 120 50	500 450 320 200 80			$I_C = -10\text{mA}, V_{CE} = -2\text{V}$ $I_C = -100\text{mA}, V_{CE} = -2\text{V}$ $I_C = -0.5\text{A}, V_{CE} = -2\text{V}$ $I_C = -1\text{A}, V_{CE} = -2\text{V}$ $I_C = -1.5\text{A}, V_{CE} = -2\text{V}$
Collector-Emitter Saturation Voltage (Note 6)	$V_{CE(sat)}$		-33 -130 -230 -315	-50 -180 -320 -450	mV mV mV mV	$I_C = -100\text{mA}, I_B = -10\text{mA}$ $I_C = -500\text{mA}, I_B = -20\text{mA}$ $I_C = -1\text{A}, I_B = -50\text{mA}$ $I_C = -1.5\text{A}, I_B = -100\text{mA}$
Base-Emitter Turn-On Voltage (Note 6)	$V_{BE(on)}$		-0.85	-1.0	V	$I_C = -1.25\text{A}, V_{CE} = -2\text{V}$
Base-Emitter Saturation Voltage (Note 6)	$V_{BE(sat)}$		-0.95	-1.1	V	$I_C = -1.25\text{A}, I_B = -100\text{mA}$
Equivalent On-Resistance	$R_{CE(sat)}$		210		m Ω	$I_C = -1.5\text{A}$
Output Capacitance	C_{obo}		9	12	pF	$V_{CB} = -10\text{V}, f = 1\text{MHz}$
Transition Frequency	f_T		265		MHz	$V_{CE} = -10\text{V}, I_C = -50\text{mA}, f = 100\text{MHz}$
Turn-On Time	t_{on}		108		ns	$V_{CC} = -10\text{V}, I_C = -1\text{A}$
Turn-Off Time	t_{off}		121		ns	$I_{B1} = I_{B2} = -10\text{mA}$

- Note: 6. Measured under pulsed conditions. Pulse width $\leq 300 \mu\text{s}$. Duty cycle $\leq 2\%$

Typical Electrical Characteristics

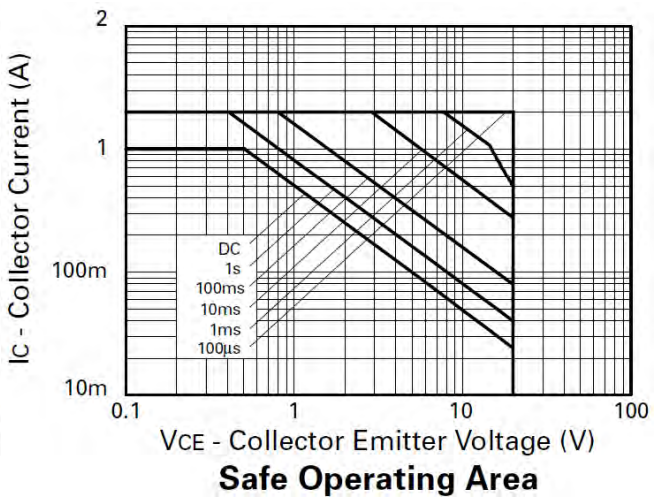
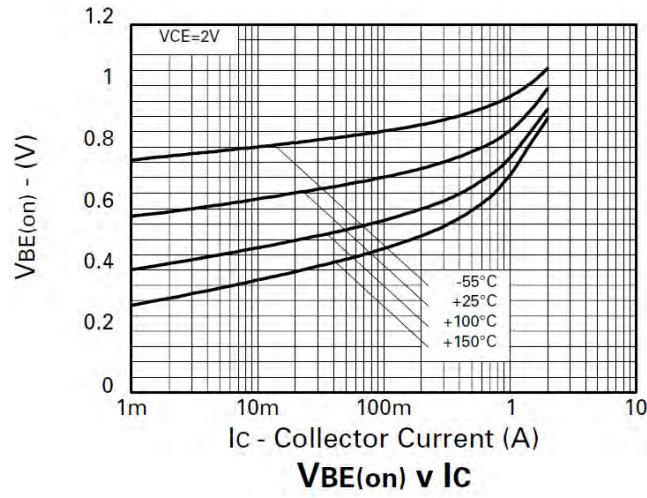
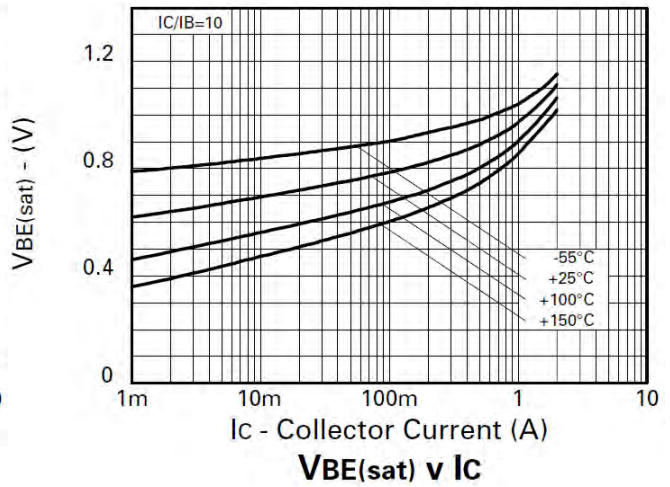
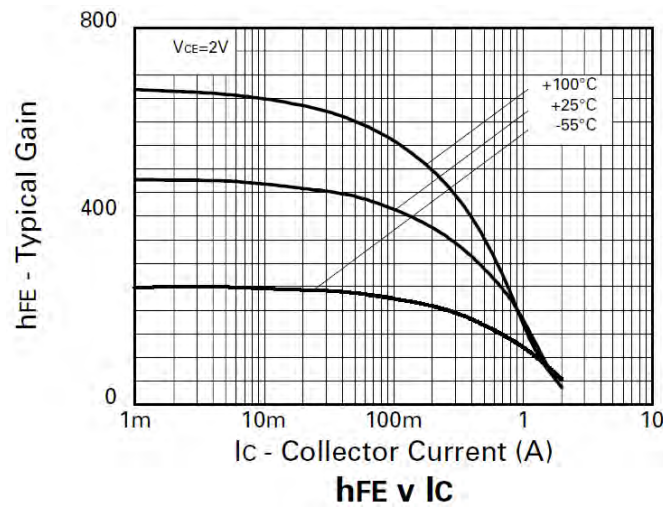
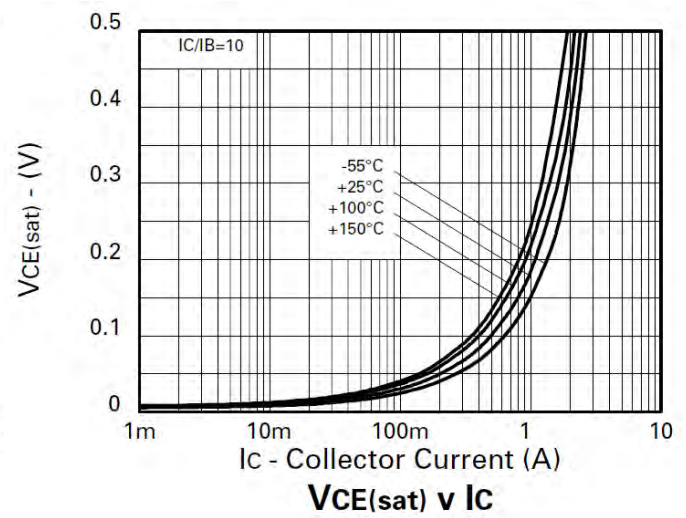
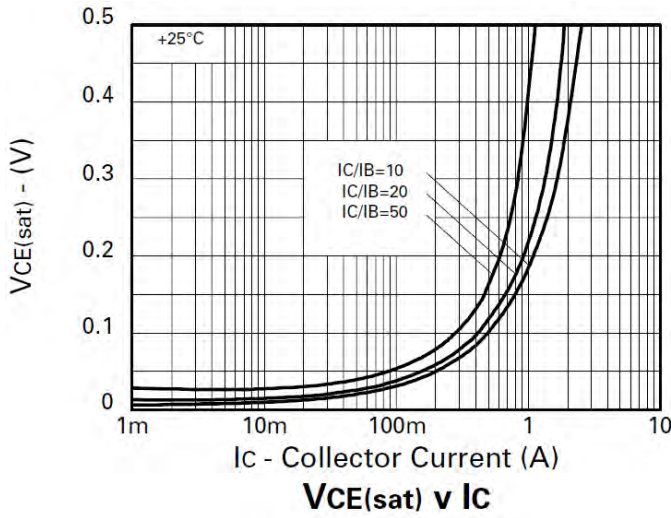

Package Outline Dimensions

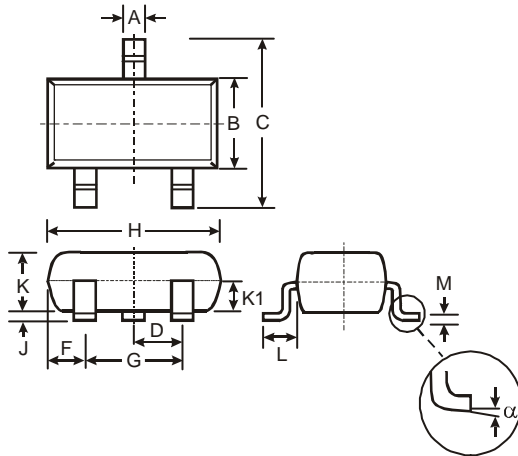

SOT23			
Dim	Min	Max	Typ
A	0.37	0.51	0.40
B	1.20	1.40	1.30
C	2.30	2.50	2.40
D	0.89	1.03	0.915
F	0.45	0.60	0.535
G	1.78	2.05	1.83
H	2.80	3.00	2.90
J	0.013	0.10	0.05
K	0.903	1.10	1.00
K1	-	-	0.400
L	0.45	0.61	0.55
M	0.085	0.18	0.11
α	0°	8°	-
All Dimensions in mm			

Suggested Pad Layout

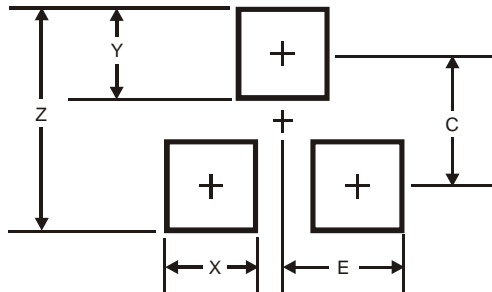

Dimensions	Value (in mm)
Z	2.9
X	0.8
Y	0.9
C	2.0
E	1.35

IMPORTANT NOTICE

DIODES INCORPORATED MAKES NO WARRANTY OF ANY KIND, EXPRESS OR IMPLIED, WITH REGARDS TO THIS DOCUMENT, INCLUDING, BUT NOT LIMITED TO, THE IMPLIED WARRANTIES OF MERCHANTABILITY AND FITNESS FOR A PARTICULAR PURPOSE (AND THEIR EQUIVALENTS UNDER THE LAWS OF ANY JURISDICTION).

Diodes Incorporated and its subsidiaries reserve the right to make modifications, enhancements, improvements, corrections or other changes without further notice to this document and any product described herein. Diodes Incorporated does not assume any liability arising out of the application or use of this document or any product described herein; neither does Diodes Incorporated convey any license under its patent or trademark rights, nor the rights of others. Any Customer or user of this document or products described herein in such applications shall assume all risks of such use and will agree to hold Diodes Incorporated and all the companies whose products are represented on Diodes Incorporated website, harmless against all damages.

Diodes Incorporated does not warrant or accept any liability whatsoever in respect of any products purchased through unauthorized sales channel. Should Customers purchase or use Diodes Incorporated products for any unintended or unauthorized application, Customers shall indemnify and hold Diodes Incorporated and its representatives harmless against all claims, damages, expenses, and attorney fees arising out of, directly or indirectly, any claim of personal injury or death associated with such unintended or unauthorized application.

Products described herein may be covered by one or more United States, international or foreign patents pending. Product names and markings noted herein may also be covered by one or more United States, international or foreign trademarks.

LIFE SUPPORT

Diodes Incorporated products are specifically not authorized for use as critical components in life support devices or systems without the express written approval of the Chief Executive Officer of Diodes Incorporated. As used herein:

- A. Life support devices or systems are devices or systems which:
1. are intended to implant into the body, or
 2. support or sustain life and whose failure to perform when properly used in accordance with instructions for use provided in the labeling can be reasonably expected to result in significant injury to the user.
- B. A critical component is any component in a life support device or system whose failure to perform can be reasonably expected to cause the failure of the life support device or to affect its safety or effectiveness.

Customers represent that they have all necessary expertise in the safety and regulatory ramifications of their life support devices or systems, and acknowledge and agree that they are solely responsible for all legal, regulatory and safety-related requirements concerning their products and any use of Diodes Incorporated products in such safety-critical, life support devices or systems, notwithstanding any devices- or systems-related information or support that may be provided by Diodes Incorporated. Further, Customers must fully indemnify Diodes Incorporated and its representatives against any damages arising out of the use of Diodes Incorporated products in such safety-critical, life support devices or systems.

Copyright © 2011, Diodes Incorporated

www.diodes.com



Компания «ЭлектроПласт» предлагает заключение долгосрочных отношений при поставках импортных электронных компонентов на взаимовыгодных условиях!

Наши преимущества:

- Оперативные поставки широкого спектра электронных компонентов отечественного и импортного производства напрямую от производителей и с крупнейших мировых складов;
- Поставка более 17-ти миллионов наименований электронных компонентов;
- Поставка сложных, дефицитных, либо снятых с производства позиций;
- Оперативные сроки поставки под заказ (от 5 рабочих дней);
- Экспресс доставка в любую точку России;
- Техническая поддержка проекта, помощь в подборе аналогов, поставка прототипов;
- Система менеджмента качества сертифицирована по Международному стандарту ISO 9001;
- Лицензия ФСБ на осуществление работ с использованием сведений, составляющих государственную тайну;
- Поставка специализированных компонентов (Xilinx, Altera, Analog Devices, Intersil, Interpoint, Microsemi, Aeroflex, Peregrine, Syfer, Eurofarad, Texas Instrument, Miteq, Cobham, E2V, MA-COM, Hittite, Mini-Circuits, General Dynamics и др.);

Помимо этого, одним из направлений компании «ЭлектроПласт» является направление «Источники питания». Мы предлагаем Вам помощь Конструкторского отдела:

- Подбор оптимального решения, техническое обоснование при выборе компонента;
- Подбор аналогов;
- Консультации по применению компонента;
- Поставка образцов и прототипов;
- Техническая поддержка проекта;
- Защита от снятия компонента с производства.



Как с нами связаться

Телефон: 8 (812) 309 58 32 (многоканальный)

Факс: 8 (812) 320-02-42

Электронная почта: org@eplast1.ru

Адрес: 198099, г. Санкт-Петербург, ул. Калинина, дом 2, корпус 4, литера А.