

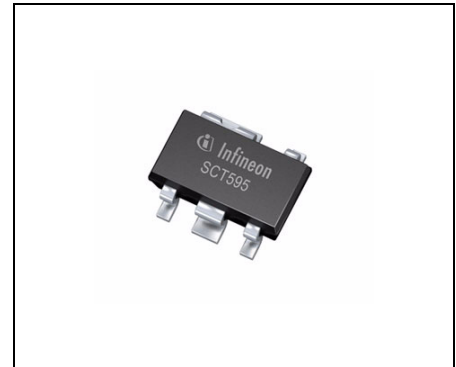

Features

- 15 mA output current capability
- 1 μ A current consumption in standby mode
- Low quiescent current consumption
60 μ A in ON mode
- Inhibit input
- Very small SMD-Package PG-SCT-595-5
- Wide operation range: 6.2 V to 42 V
- Wide temperature range: -40 °C to 150 °C
- Output protected against short circuit
- Overtemperature protection
- Green product (RoHS compliant)
- AEC qualified.



PG-SCT-595-5

Functional Description

The **TLE 4286 G** is a 5-V low-drop fixed voltage regulator in the very small SMD package PG-SCT-595-5. The maximum input voltage is 42 V. The output is able to drive a load of more than 10 mA while it regulates the output voltage within a 4% accuracy.

The device can be switched in stand-by mode via an inhibit input which causes the current consumption to drop below 1 μ A.

A temperature protection disables the IC at over temperature.

Type	Package	Marking
TLE 4286 G	PG-SCT-595-5	A1

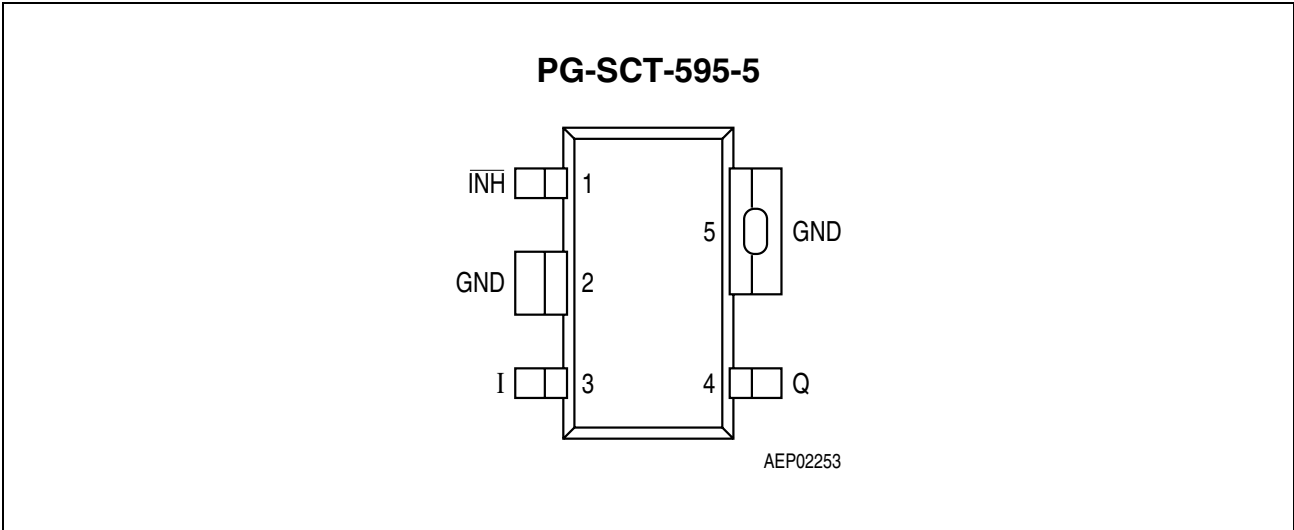

Figure 1 Pin Configuration (top view)

Table 1 Pin Definitions and Functions

Pin No.	Symbol	Function
1	INH	Inhibit input; H for active ($V_Q = 5\text{ V}$) and L for stand-by
2	GND	Ground; internally connected to pin 5
3	I	Input voltage
4	Q	Output voltage; must be blocked by a capacitor $C_Q \geq 1\ \mu\text{F}$, $\text{ESR} \leq 10\ \Omega$ to GND
5	GND	Ground; internally connected to pin 2

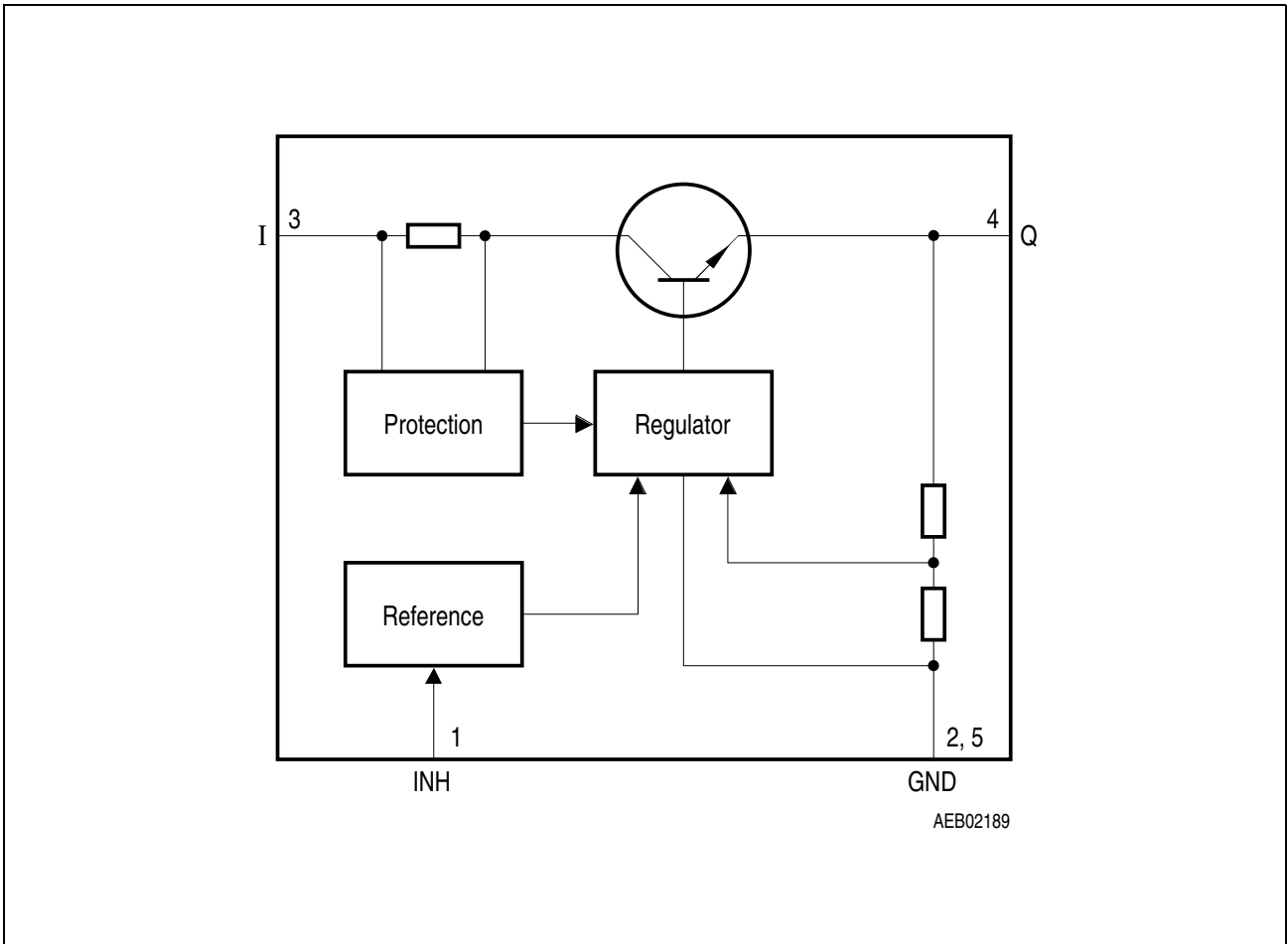

Figure 2 **Block Diagram**

Table 2 Absolute Maximum Ratings
 $-40\text{ °C} < T_j < 150\text{ °C}$

Parameter	Symbol	Limit Values		Unit	Remarks
		Min.	Max.		
Input					
Voltage	V_I	-0.3	45	V	–
Current	I_I	-20	*	mA	* internally limited
Output					
Voltage	V_Q	-0.3	16	V	–
Current	I_Q	-20	*	mA	* internally limited
Inhibit					
Voltage	V_{INH}	-40	45	V	–
Current	I_{INH}	-500	*	μA	* internally limited
Current	I_{INH}	-5	5	mA	$-0.3\text{ V} < V_I < 45\text{ V};$ $t < 1\text{ ms}$
Temperatures					
Junction temperature	T_j	-40	150	$^{\circ}\text{C}$	–
Storage temperature	T_{stg}	-50	150	$^{\circ}\text{C}$	–
Thermal Resistances					
Junction pin	$R_{thj-pin}$	–	30	K/W	measured to pin 5
Junction ambient ¹⁾	R_{thja}	–	179	K/W	zero airflow zero heat sink area

1) Worst case regarding peak temperature.

Note: Maximum ratings are absolute ratings; exceeding any one of these values may cause irreversible damage to the integrated circuit.

Table 3 Operating Range

Parameter	Symbol	Limit Values		Unit	Remarks
		Min.	Max.		
Input voltage	V_I	6.0	42	V	–
Inhibit input voltage	V_{INH}	-0.3	40	V	–
Junction temperature	T_j	-40	150	$^{\circ}\text{C}$	–

Table 4 Electrical Characteristics
 $6.2\text{ V} < V_I < 36\text{ V}; V_{\text{INH}} > V_{\text{INH, ON}}; -40\text{ }^\circ\text{C} < T_j < 150\text{ }^\circ\text{C};$ unless otherwise specified

Parameter	Symbol	Limit Values			Unit	Test Condition
		Min.	Typ.	Max.		
Output						
Output voltage	V_Q	4.85	5.0	5.15	V	$T_j = 25\text{ }^\circ\text{C};$ $1\text{ mA} < I_Q < 10\text{ mA}$
Output voltage	V_Q	4.8	5.0	5.20	V	$1\text{ mA} < I_Q < 10\text{ mA}$
Drop voltage	V_{dr}	0.6	0.8	1.1	V	$I_Q = 10\text{ mA}$
Output capacitor	C_Q	1	–	–	μF	$\text{ESR} \leq 10\ \Omega$ at 10 kHz
Output current	I_Q	15	–	70	mA	–
Current Consumption						
Quiescent current	I_q	–	60	100	μA	$I_Q < 10\text{ mA};$ $V_I = 13.5\text{ V}$
Quiescent current (stand-by)	I_q	–	–	1	μA	$V_{\text{INH}} < V_{\text{INH, OFF}};$ $T_j < 85\text{ }^\circ\text{C}$
Quiescent current (stand-by)	I_q	–	–	5	μA	$V_{\text{INH}} < V_{\text{INH, OFF}}$
Regulator Performance						
Load regulation	ΔV_Q	–	5	10	mV	$0\text{ mA} < I_Q < 10\text{ mA};$ $V_I = 6.2\text{ V};$ $T_j \leq 85\text{ }^\circ\text{C}$
Line regulation	ΔV_Q	–	5	10	mV	$I_Q = 5\text{ mA};$ $T_j \leq 85\text{ }^\circ\text{C}$
Power supply ripple rejection	$PSRR$	–	60	–	dB	$f_r = 100\text{ Hz};$ $V_r = 0.5\text{ Vpp}$
Logic Inhibit Input						
Inhibit ON-threshold	$V_{\text{INH, ON}}$	–	–	3.5	V	$V_Q \geq 4.8\text{ V}$
Inhibit OFF-threshold	$V_{\text{INH, OFF}}$	0.3	–	–	V	$V_Q \leq 0.8\text{ V}$
Inhibit input current H-state	$I_{\text{INH, ON}}$	–	10	15	μA	$V_{\text{INH}} = 5\text{ V}$
Inhibit input current L-state	$I_{\text{INH, OFF}}$	-2	0	2	μA	$V_{\text{INH}} = 0\text{ V}$

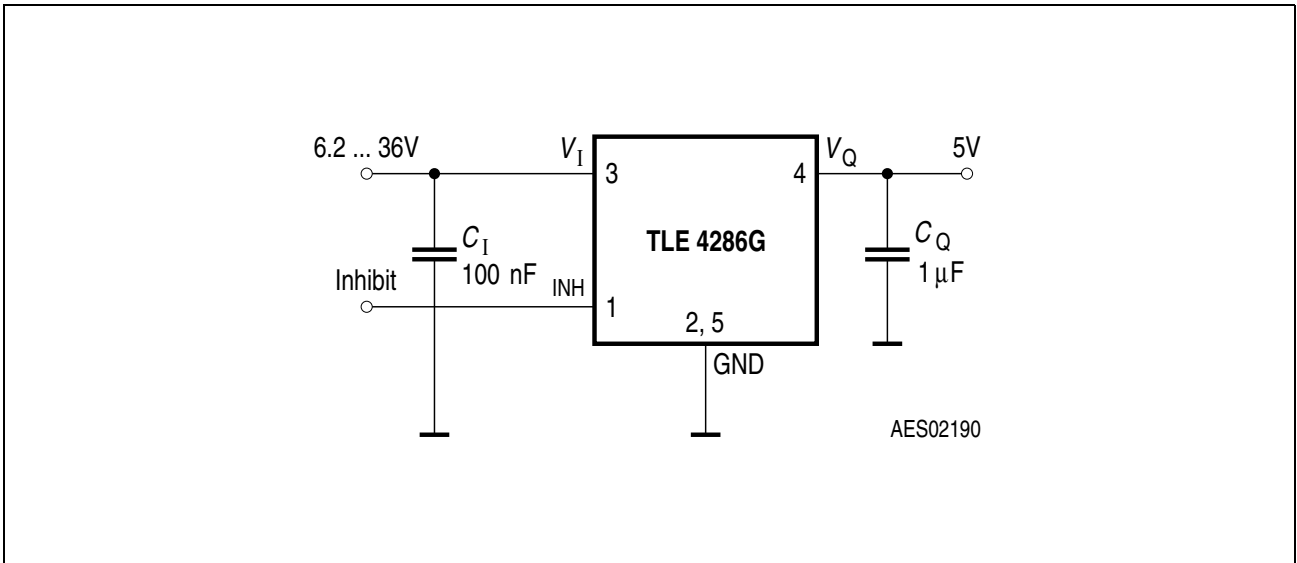
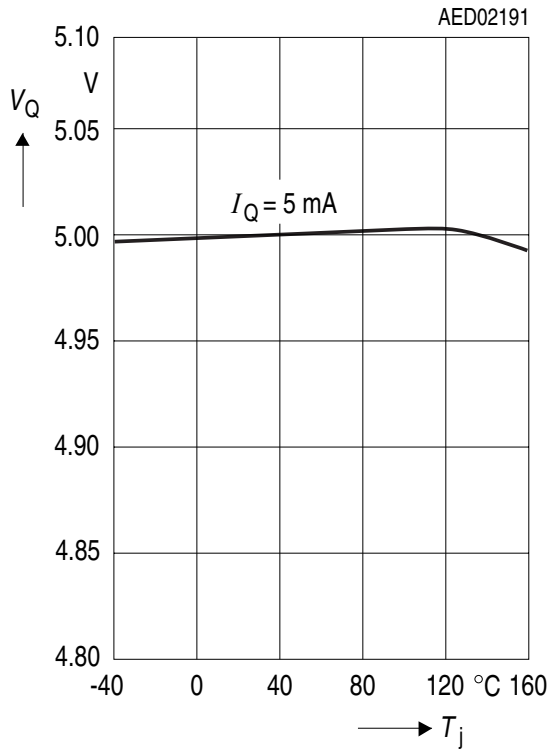

Figure 3 Application Circuit

Typical Performance Characteristics

Output Voltage V_Q versus Temperature T_j



Output Voltage V_Q versus Output Current I_Q

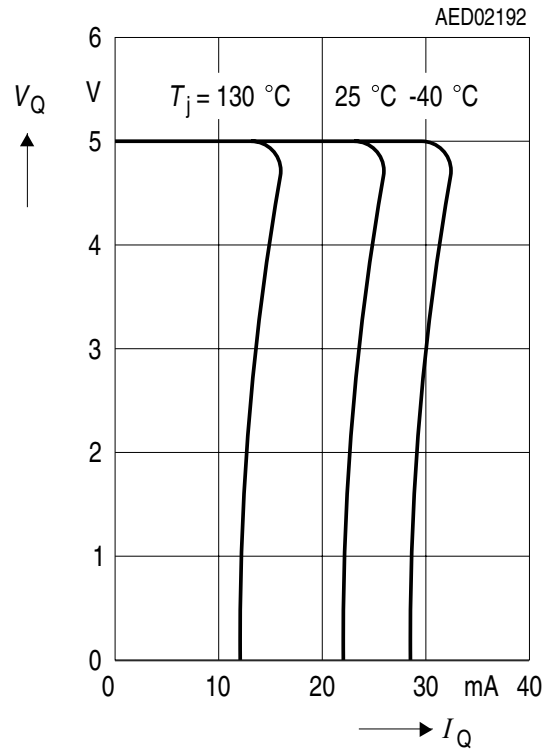

Current Consumption I_q versus Output Current I_Q

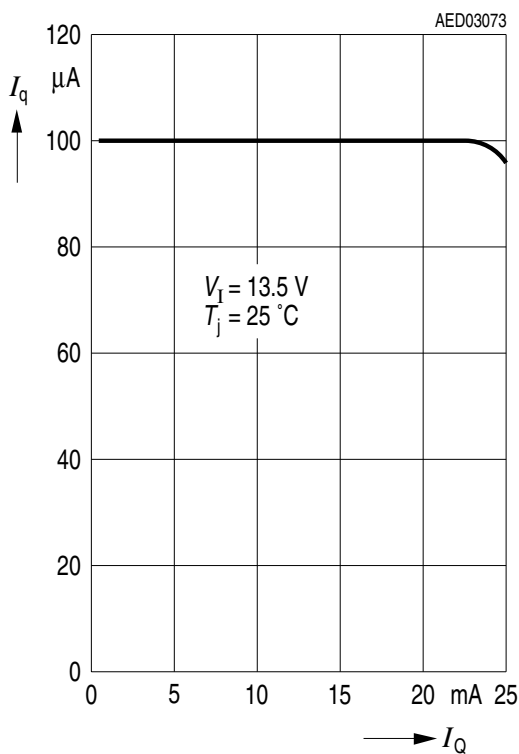

Current Consumption I_q versus Input Voltage V_I

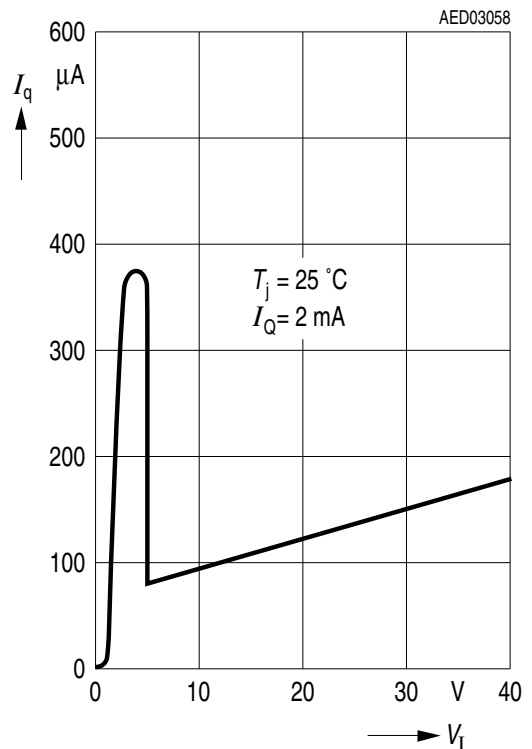

Drop Voltage V_{dr} versus Output Current I_Q

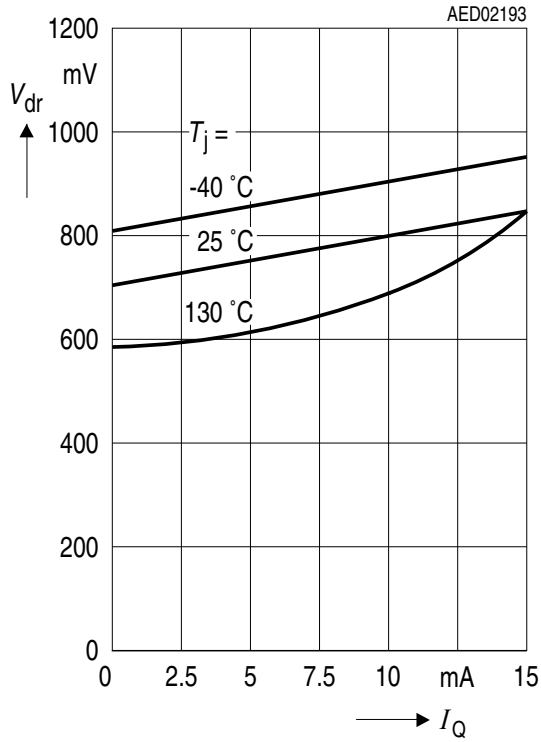

Inhibit Voltage V_{INH} versus Inhibit Current I_{INH}

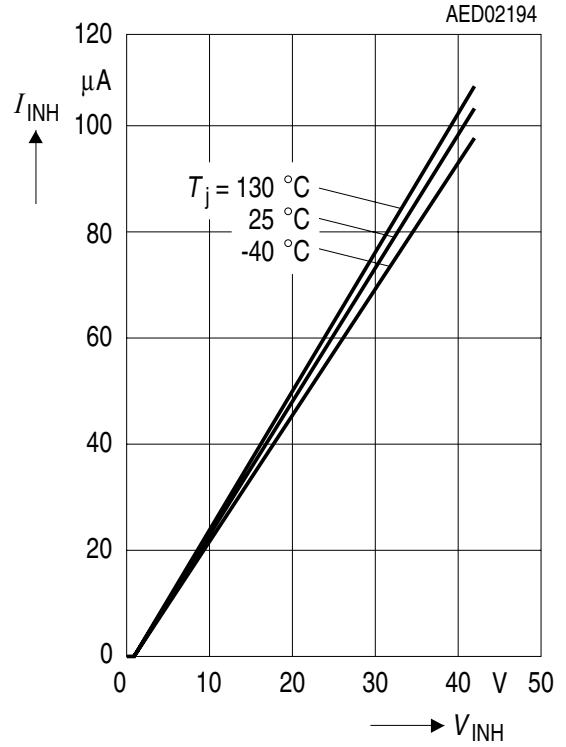

Output Voltage V_Q versus Input Voltage V_I

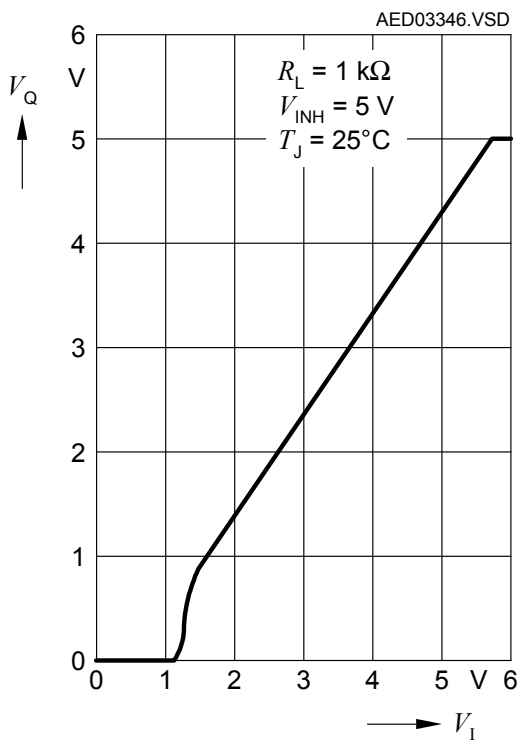

Package Outlines

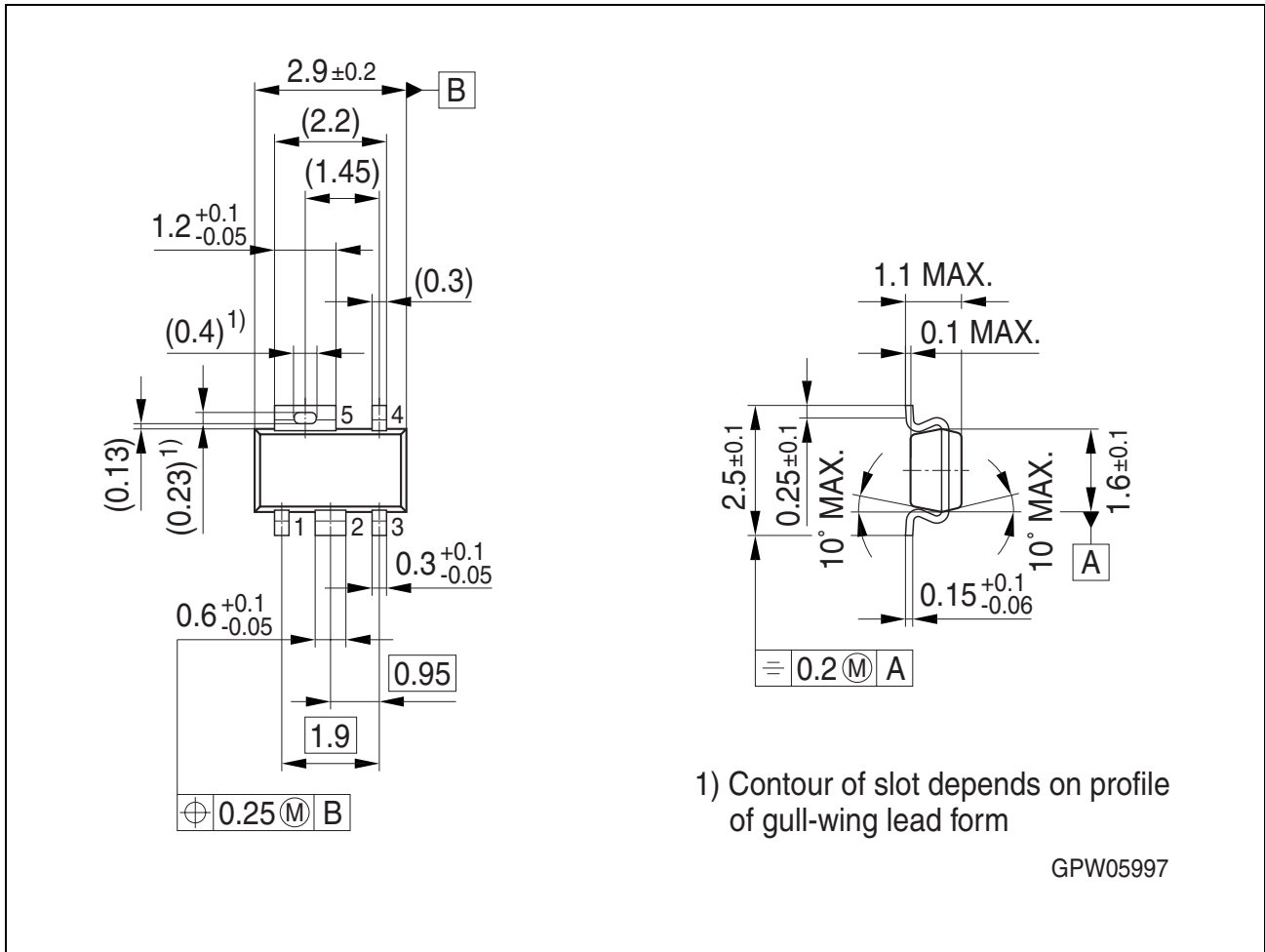

Figure 4 Outline PG-SCT-595-5

Green Product (RoHS compliant)

To meet the world-wide customer requirements for environmentally friendly products and to be compliant with government regulations the device is available as a green product. Green products are RoHS-Compliant (i.e Pb-free finish on leads and suitable for Pb-free soldering according to IPC/JEDEC J-STD-020).

You can find all of our packages, sorts of packing and others in our Infineon Internet Page "Products": <http://www.infineon.com/packages>.

SMD = Surface Mounted Device

Dimensions in mm

Revision History

Version	Date	Changes
Rev. 2.3	2008-04-21	Initial version of RoHS-compliant derivate of TLE 4286 G. Page 1 : AEC certified statement added. Page 1 and Page 9 : RoHS compliance statement and Green product feature added. Page 1 and Page 9 : Package changed to RoHS compliant version. Page 1 : Marking information added. Page 1 : Adapted description to values given on Page 5 . Not a change of electrical characteristics. Legal Disclaimer updated
Rev. 2.2	2004-01-01	Final datasheet

Edition 2008-04-21

**Published by
Infineon Technologies AG
81726 Munich, Germany**

**© 2008 Infineon Technologies AG
All Rights Reserved.**

Legal Disclaimer

The information given in this document shall in no event be regarded as a guarantee of conditions or characteristics. With respect to any examples or hints given herein, any typical values stated herein and/or any information regarding the application of the device, Infineon Technologies hereby disclaims any and all warranties and liabilities of any kind, including without limitation, warranties of non-infringement of intellectual property rights of any third party.

Information

For further information on technology, delivery terms and conditions and prices, please contact the nearest Infineon Technologies Office (www.infineon.com).

Warnings

Due to technical requirements, components may contain dangerous substances. For information on the types in question, please contact the nearest Infineon Technologies Office.

Infineon Technologies components may be used in life-support devices or systems only with the express written approval of Infineon Technologies, if a failure of such components can reasonably be expected to cause the failure of that life-support device or system or to affect the safety or effectiveness of that device or system. Life support devices or systems are intended to be implanted in the human body or to support and/or maintain and sustain and/or protect human life. If they fail, it is reasonable to assume that the health of the user or other persons may be endangered.

Mouser Electronics

Authorized Distributor

Click to View Pricing, Inventory, Delivery & Lifecycle Information:

[Infineon:](#)

[TLE4286GNTSA1](#) [TLE4286G](#) [TLE4286GHTSA1](#)



Компания «ЭлектроПласт» предлагает заключение долгосрочных отношений при поставках импортных электронных компонентов на взаимовыгодных условиях!

Наши преимущества:

- Оперативные поставки широкого спектра электронных компонентов отечественного и импортного производства напрямую от производителей и с крупнейших мировых складов;
- Поставка более 17-ти миллионов наименований электронных компонентов;
- Поставка сложных, дефицитных, либо снятых с производства позиций;
- Оперативные сроки поставки под заказ (от 5 рабочих дней);
- Экспресс доставка в любую точку России;
- Техническая поддержка проекта, помощь в подборе аналогов, поставка прототипов;
- Система менеджмента качества сертифицирована по Международному стандарту ISO 9001;
- Лицензия ФСБ на осуществление работ с использованием сведений, составляющих государственную тайну;
- Поставка специализированных компонентов (Xilinx, Altera, Analog Devices, Intersil, Interpoint, Microsemi, Aeroflex, Peregrine, Syfer, Eurofarad, Texas Instrument, Miteq, Cobham, E2V, MA-COM, Hittite, Mini-Circuits, General Dynamics и др.);

Помимо этого, одним из направлений компании «ЭлектроПласт» является направление «Источники питания». Мы предлагаем Вам помощь Конструкторского отдела:

- Подбор оптимального решения, техническое обоснование при выборе компонента;
- Подбор аналогов;
- Консультации по применению компонента;
- Поставка образцов и прототипов;
- Техническая поддержка проекта;
- Защита от снятия компонента с производства.



Как с нами связаться

Телефон: 8 (812) 309 58 32 (многоканальный)

Факс: 8 (812) 320-02-42

Электронная почта: org@eplast1.ru

Адрес: 198099, г. Санкт-Петербург, ул. Калинина, дом 2, корпус 4, литера А.