

Product Description

The QPA3333 is a Power Doubler amplifier SMD Module. The part employs GaAs MESFET, GaAs pHEMT and GaN HEMT die and is operated from 45MHz to 1218MHz. It provides excellent linearity and superior return loss performance with low noise and optimal reliability. DC current of the device can be externally adjusted for optimum distortion performance versus power consumption over a wide range of output level.

Functional Block Diagram

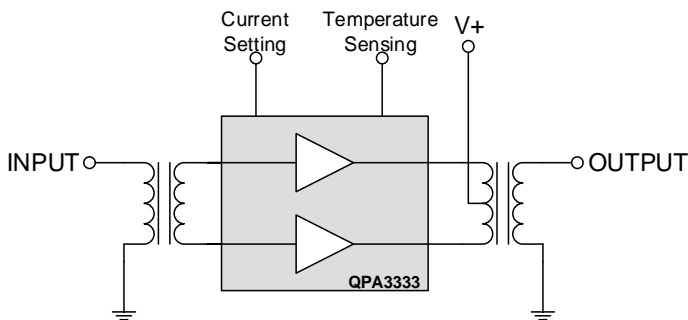

9 pin, 11.0 mm x 8.5 mm x 1.375 mm package

Product Features

- Excellent Linearity
- Superior Return Loss Performance
- Extremely Low Distortion
- Optimal Reliability
- Low Noise
- Unconditionally Stable Under all Terminations
- 27.0dB Min Gain at 1218 MHz
- 470mA max at 24 VDC

Applications

- 45 – 1218 MHz CATV Amplifier Systems

Ordering Information

Part No.	Description
QPA3333SB	Sample bag 5 pcs
QPA3333SQ	Sample bag 25 pcs
QPA3333SR	7" Reel with 100 pcs
QPA3333TR7	7" Reel with 500 pcs
QPA3333TR13	13" Reel with 1000 pcs
QPA3333PCBA-410	Fully assembled Evaluation Board

Absolute Maximum Ratings

Parameter	Value / Range
DC Supply over-voltage (5 minutes)	+30V
Storage Temperature	-40 to +100 °C
Operating Mounting Base Temperature	-30 to +100 °C
Moisture Sensitivity Level IPC/JEDEC J-STD-20	MSL3 @ 260 °C
RF Input Voltage (single tone; on Evaluation Board)	75dBmV

Operation of this device outside the parameter ranges given above may cause permanent damage.

Electrical Specifications

Parameter	Conditions (V+=24V, TMB=30°C, ZS=ZL=75Ω, Pin3 not connected)	Min	Typ	Max	Units
Operational Frequency Range	–	45	–	1218	MHz
Current (I _{DD})	–		450	470	mA
Gain	f _o = 45 MHz		26.3		dB
Gain	f _o = 1218 MHz	27.0	27.8	29.0	
Gain Slope	45 to 1218 MHz ^[1]		1.4		
Gain Flatness	45 to 1218 MHz		0.6		
Input Return Loss (-S ₁₁)	f _o = 45 to 320 MHz	20		–	dB
	f _o = 320 to 640 MHz	19		–	
	f _o = 640 to 870 MHz	19		–	
	f _o = 870 to 1003 MHz	17		–	
	f _o = 1003 to 1218 MHz	16		–	
Output Return Loss (-S ₂₂)	f _o = 45 to 320 MHz	20		–	dB
	f _o = 320 to 640 MHz	19		–	
	f _o = 640 to 870 MHz	19		–	
	f _o = 870 to 1003 MHz	17		–	
	f _o = 1003 to 1218 MHz	16		–	
Noise Figure	f _o = 50 to 1218 MHz		4.6	5.0	dB
Thermal Resistance	Junction to Mounting Base		3.6		K/W
CTB	V _o = 58dBmV at 1218MHz, 16.5dB extrapolated tilt, 79 analog channels plus 111 digital channels (-6dB offset) ^[2,3]		-80	-76	dBc
XMOD			-75	-70	dBc
CSO			-74	-70	dBc
CIN			56	60	

Notes:

- The slope is defined as the difference between the gain at the start frequency and the gain at the stop frequency.
- 79 analog channels, NTSC frequency raster: 55.25MHz to 547.25MHz, +41.5dBmV to +48.5dBmV tilted output level, plus 111 digital channels, -6dB offset relative to the equivalent analog carrier.
- Composite Second Order (CSO) – The CSO parameter (both sum and difference products) is defined by ANSI/SCTE 6. Composite Triple Beat (CTB) – The CTB parameter is defined by ANSI/SCTE6. Cross Modulation (XMOD) – Cross modulation (XMOD) is measured at baseband (selective voltmeter method), referenced to 100% modulation of carrier being tested, Carrier to Intermodulation Noise (CIN) – The CIN parameter is defined by ANSI/SCTE17 (Test procedure for carrier to noise)

Evaluation Board Assembly Drawing

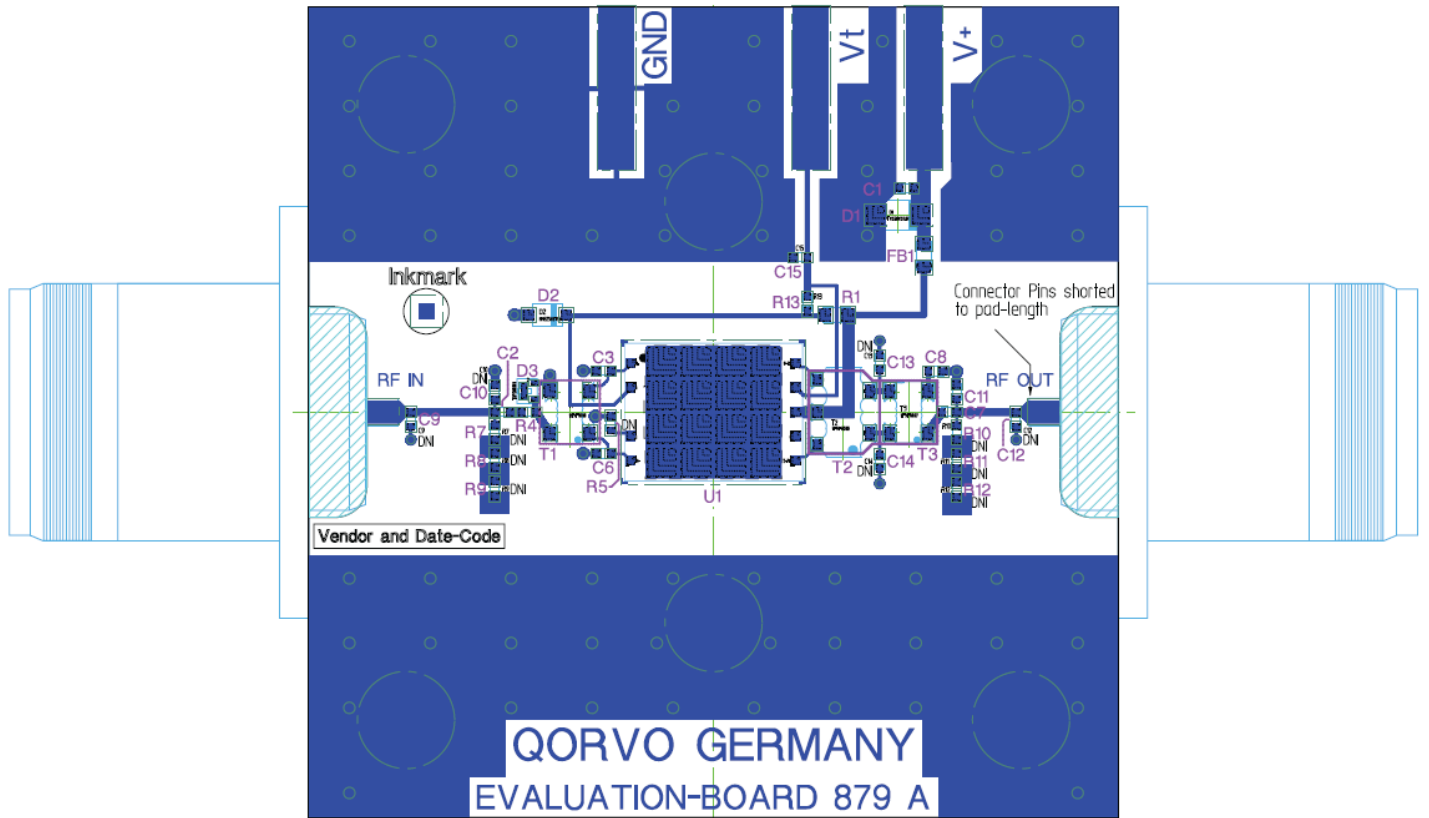

Note:
The ground plane of the QPA3333 module should be soldered onto a board equipped with as many thermal vias as possible. Underneath this thermal via array a heat sink with thermal grease needs to be placed which is able to dissipate the complete module DC power (up to 11.3 Watts). In any case the module backside temperature should not exceed 100°C.

Evaluation Board Schematic

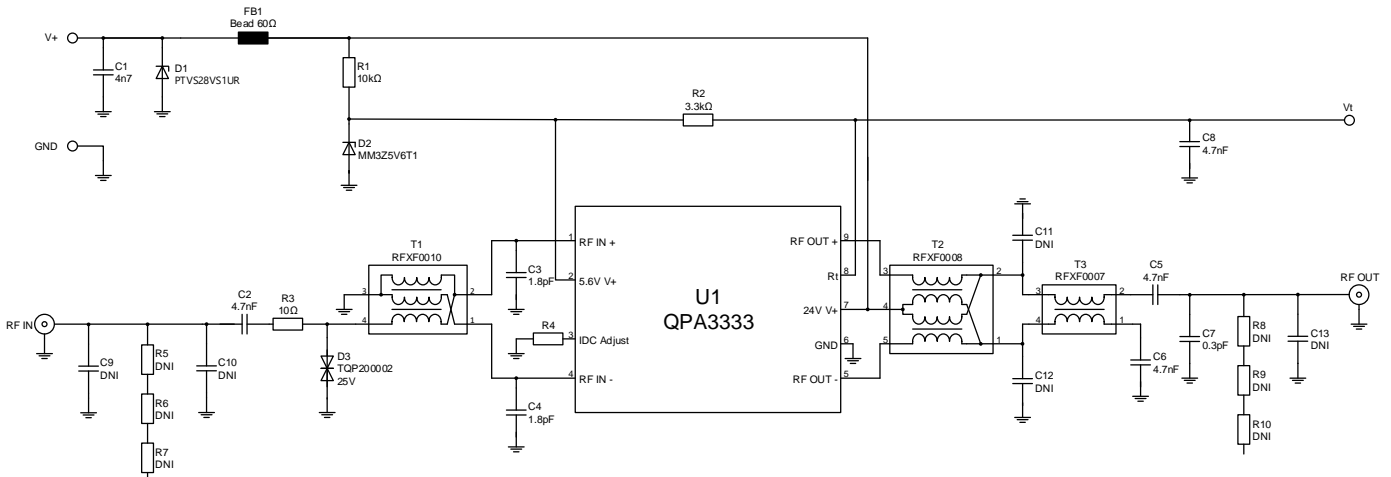

Evaluation Board Bill of Materials (BOM)

Reference Des.	Value	Description	Manuf.	Part Number
n/a	n/a	Printed Circuit Board	Qorvo	
C1, C2, C5, C6, C8	4.7nF	Cap., 0402, 10%, 50V, X7R	various	
C3, C4	1.8pF	Cap., 0402, ±0.25pF, 50V, C0G	various	
C7	0.3pF	Cap., 0402, ±0.1pF, 50V, C0G	various	
C9, C10, C11, C12, C13	DNI			
R1	10kΩ	Res., 0603, ±1%, TK100	various	
R2	3.3kΩ	Res., 0402, ±1%, TK100	various	
R3	10Ω	Res., 0402, ±1%, TK100	various	
R4	See page 5	Optional to set current value	various	
R5, R6, R7, R8, R9, R10	DNI	Res., 0402, 0Ω, TK100	various	
FB1	60Ω at 100MHz	Impedance Bead	Taiyo Yuden	BK 1608 HS 600
D1	28V	Transient Voltage Suppressor Diode	NXP	PTVS28VS1UR
D2	5.6V	Zener Diode	ON Semiconductor	MM3Z5V6T1G
D3	25V	ESD Diode	Qorvo / Unisem	TQP200002
T1	RFXF0010	Transformer	Qorvo	RFXF0010
T2	RFXF0008	Transformer	Qorvo	RFXF0008
T3	RFXF0007	Transformer	Qorvo	RFXF0007
U1	QPA3333	CATV Power Doubler Module	Qorvo	QPA3333

Current Adjustment

The QPA3333 can be operated over a wide range of current to provide maximum required performance with minimum current consumption. Changing the value of resistor R4 on application circuit allows a variation of the current between 450 mA and 320 mA (typ.). Within the recommended range of current between 450 mA and 320 mA gain (S21) change is less than 0.4 dB (typ.) and noise figure change is less than 0.2 dB (typ.).

Device Current vs. Resistor R4 (typical values)

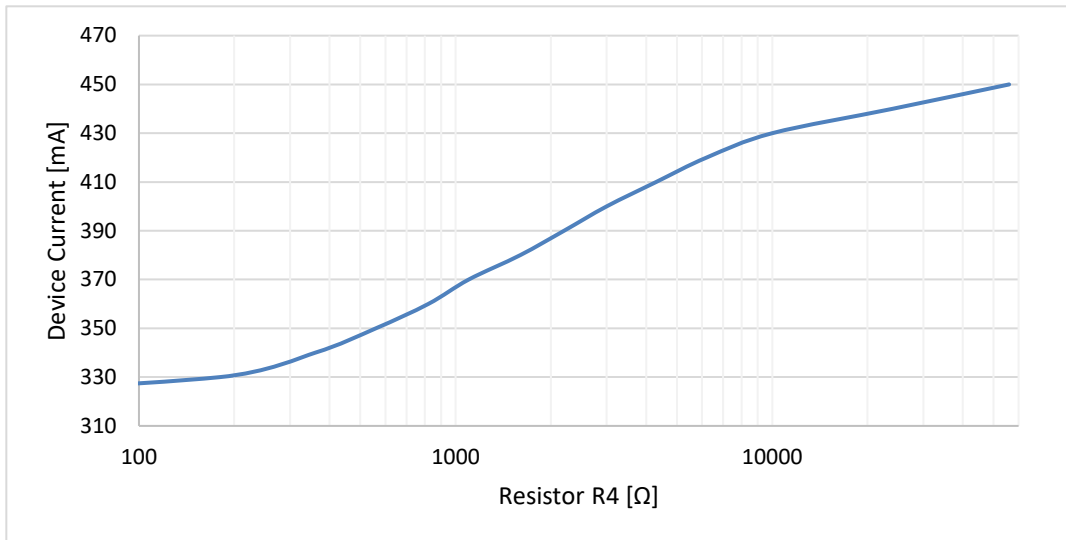

Device Current [mA] (typical)	R4 [Ω]
450	open
430	10000
410	4300
390	2200
370	1100
350	560
330	180
320	0

Device Current vs. Distortion Degradation (typical values)

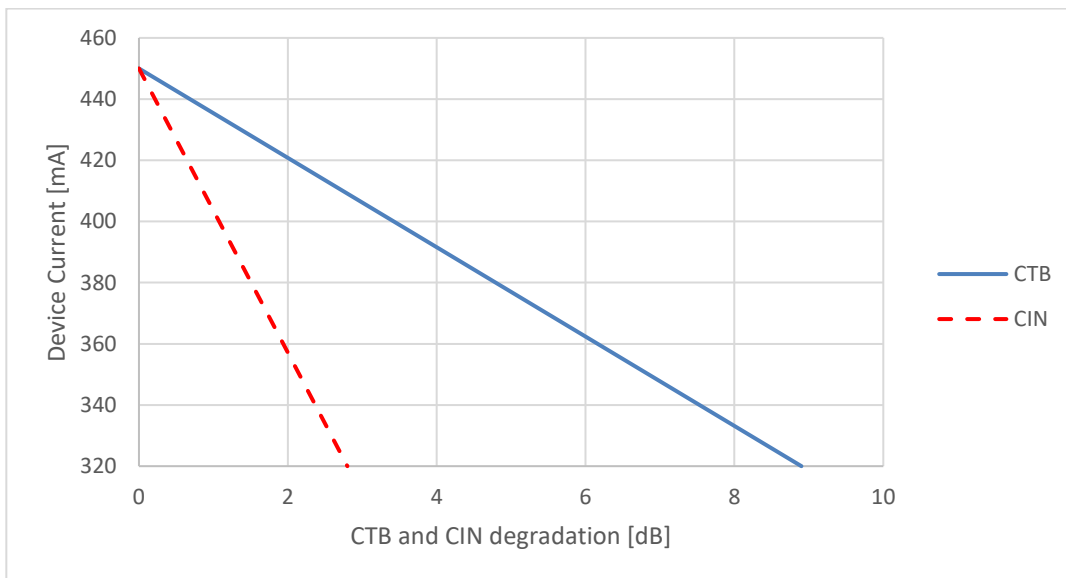

Test Condition: V+=24V, TMB=30°C, ZS=ZL=75Ω, IDC=IDC (typ.), NTSC, 79ch analog: 48.5dBmV @ 547.25 MHz; 7 dB tilt, with 111 J.83/B QAM256 channels (6 dB down)

QPA3333 Temperature Sensing Feature

The QPA3333 provides an internal NTC resistor for temperature sensing. This resistor is located right next to the output transistor stage. Within the application circuit the NTC is part of a voltage divider. The output voltage of the voltage divider (V_t) can be correlated to the module backside temperature.

Module Backside Temperature versus V_t (typical values)

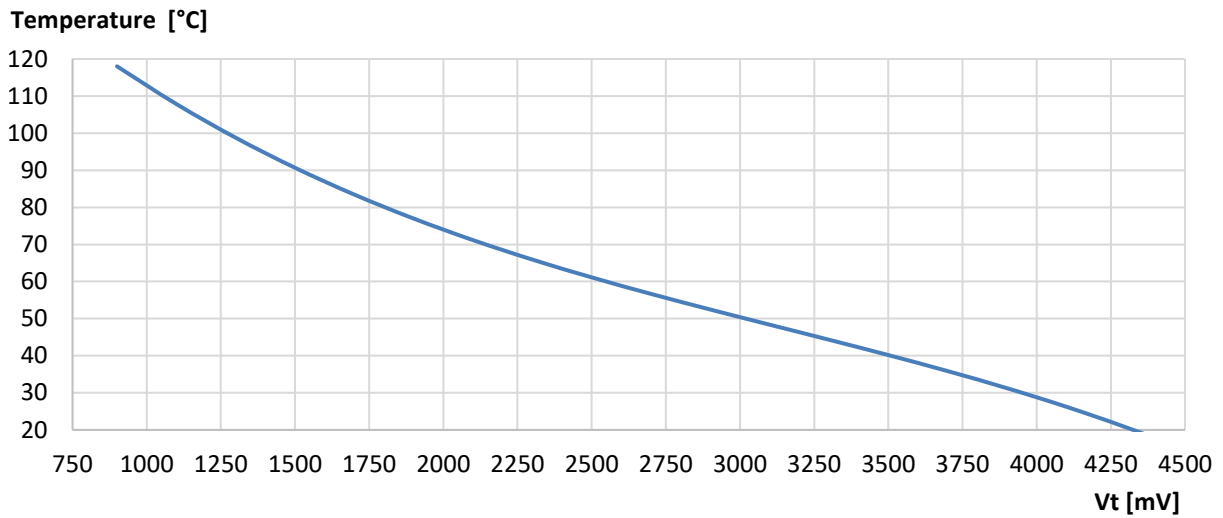

Pin Configuration

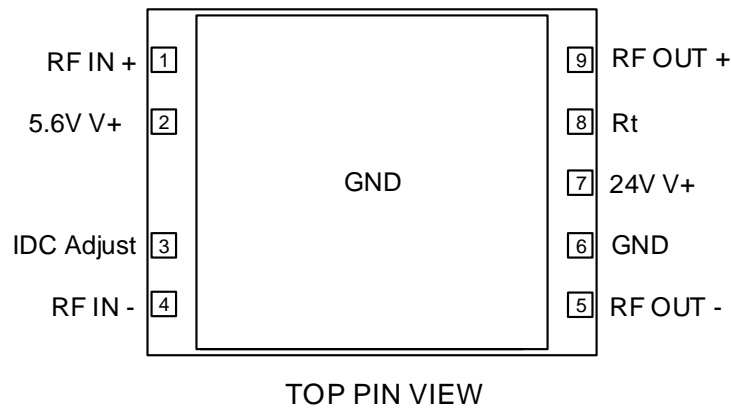

Pin Description

Pin No.	Label	Description
1	RF IN (+)	RF AMP Positive Input
2	5.6V V+	Supply Voltage 5.6V
3	IDC Adjust	Current Adjustment
4	RF IN (-)	RF AMP Negative Input
5	RF OUT (-)	RF AMP Negative Output
6	GND	Ground
7	24V V+	Supply Voltage 24V
8	Rt	NTC Output for Temperature Sensing
9	RF OUT (+)	RF AMP Positive Output

Package Outline Drawing (Dimensions in millimeters)

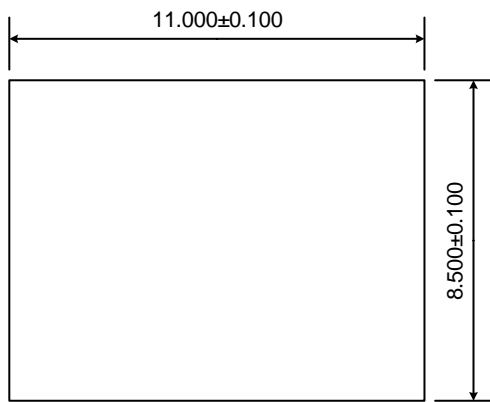

TOP VIEW

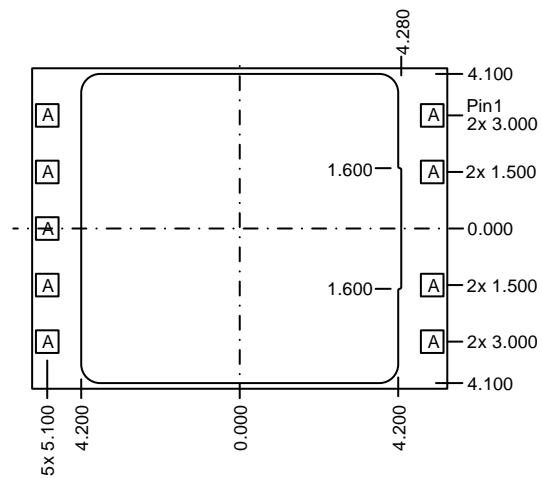

A= 0.600 x 0.600 mm

BOTTOM PIN VIEW

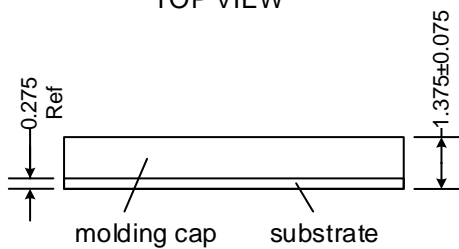

SIDE VIEW

Handling Precautions

Parameter	Rating	Standard
ESD – Human Body Model (HBM)	1B	ANSI/ESD/JEDEC JS-001
ESD – Charged Device Model (CDM)	C3	ANSI/ESD/JEDEC JS-002
MSL – Moisture Sensitivity Level	Level 3	IPC/JEDEC J-STD-020



Caution!
ESD-Sensitive Device

Solderability

Compatible with both lead-free (260°C max. reflow temp.) and tin/lead (245°C max. reflow temp.) soldering processes. Solder profiles available upon request.

Contact plating: NiPdAu

RoHS Compliance

This part is compliant with 2011/65/EU RoHS directive (Restrictions on the Use of Certain Hazardous Substances in Electrical and Electronic Equipment) as amended by Directive 2015/863/EU.

This product also has the following attributes:

- Halogen Free (Chlorine, Bromine)

Contact Information

For the latest specifications, additional product information, worldwide sales and distribution locations:

Web: www.qorvo.com

Tel: 1-844-890-8163

Email: customer.support@qorvo.com

Important Notice

The information contained herein is believed to be reliable; however, Qorvo makes no warranties regarding the information contained herein and assumes no responsibility or liability whatsoever for the use of the information contained herein. All information contained herein is subject to change without notice. Customers should obtain and verify the latest relevant information before placing orders for Qorvo products. The information contained herein or any use of such information does not grant, explicitly or implicitly, to any party any patent rights, licenses, or any other intellectual property rights, whether with regard to such information itself or anything described by such information. **THIS INFORMATION DOES NOT CONSTITUTE A WARRANTY WITH RESPECT TO THE PRODUCTS DESCRIBED HEREIN, AND QORVO HEREBY DISCLAIMS ANY AND ALL WARRANTIES WITH RESPECT TO SUCH PRODUCTS WHETHER EXPRESS OR IMPLIED BY LAW, COURSE OF DEALING, COURSE OF PERFORMANCE, USAGE OF TRADE OR OTHERWISE, INCLUDING THE IMPLIED WARRANTIES OF MERCHANTABILITY AND FITNESS FOR A PARTICULAR PURPOSE.**

Without limiting the generality of the foregoing, Qorvo products are not warranted or authorized for use as critical components in medical, life-saving, or life-sustaining applications, or other applications where a failure would reasonably be expected to cause severe personal injury or death.

Copyright 2017 © Qorvo, Inc. | Qorvo is a registered trademark of Qorvo, Inc.



Компания «ЭлектроПласт» предлагает заключение долгосрочных отношений при поставках импортных электронных компонентов на взаимовыгодных условиях!

Наши преимущества:

- Оперативные поставки широкого спектра электронных компонентов отечественного и импортного производства напрямую от производителей и с крупнейших мировых складов;
- Поставка более 17-ти миллионов наименований электронных компонентов;
- Поставка сложных, дефицитных, либо снятых с производства позиций;
- Оперативные сроки поставки под заказ (от 5 рабочих дней);
- Экспресс доставка в любую точку России;
- Техническая поддержка проекта, помощь в подборе аналогов, поставка прототипов;
- Система менеджмента качества сертифицирована по Международному стандарту ISO 9001;
- Лицензия ФСБ на осуществление работ с использованием сведений, составляющих государственную тайну;
- Поставка специализированных компонентов (Xilinx, Altera, Analog Devices, Intersil, Interpoint, Microsemi, Aeroflex, Peregrine, Syfer, Eurofarad, Texas Instrument, Miteq, Cobham, E2V, MA-COM, Hittite, Mini-Circuits, General Dynamics и др.);

Помимо этого, одним из направлений компании «ЭлектроПласт» является направление «Источники питания». Мы предлагаем Вам помощь Конструкторского отдела:

- Подбор оптимального решения, техническое обоснование при выборе компонента;
- Подбор аналогов;
- Консультации по применению компонента;
- Поставка образцов и прототипов;
- Техническая поддержка проекта;
- Защита от снятия компонента с производства.



Как с нами связаться

Телефон: 8 (812) 309 58 32 (многоканальный)

Факс: 8 (812) 320-02-42

Электронная почта: org@eplast1.ru

Адрес: 198099, г. Санкт-Петербург, ул. Калинина, дом 2, корпус 4, литера А.